

N-Channel Power MOSFET

General Features

- $V_{DS} = 30V, I_D = 4A$
- $R_{DS(ON)} < 60m\Omega @ V_{GS}=4.5V$
- $R_{DS(ON)} < 50m\Omega @ V_{GS}=10V$

Application

- DC Fan
- Charger, Fast switch
- Optimized for Power Management Applications for Portable Products, such as H-bridge, Inverters Car Charger and Others

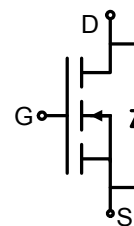

Schematic diagram

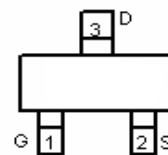

Pin Assignment



SOT-23 top view

Absolute Maximum Ratings

Symbol	Parameter	Rating	Unit
Common Ratings ($T_A=25^\circ\text{C}$ Unless Otherwise Noted)			
V_{GS}	Gate-Source Voltage	± 20	V
$V_{(BR)DSS}$	Drain-Source Breakdown Voltage	30	V
T_J	Maximum Junction Temperature	150	$^\circ\text{C}$
T_{STG}	Storage Temperature Range	-50 to 150	$^\circ\text{C}$
Mounted on Large Heat Sink			
I_{DM}	Pulse Drain Current Tested①	$T_A = 25^\circ\text{C}$	20.4 A
I_D	Continuous Drain Current($V_{GS}=4.5V$)	$T_A = 25^\circ\text{C}$	4 A
		$T_A = 70^\circ\text{C}$	3.2 A
P_D	Maximum Power Dissipation	$T_A = 25^\circ\text{C}$	1.5 W
		$T_A = 70^\circ\text{C}$	0.9 W
$R_{\theta JA}$	Thermal Resistance Junction-Ambient	80–100	$^\circ\text{C/W}$

Electrical Characteristics

Symbol	Parameter	Condition	Min	Typ	Max	Unit
Static Electrical Characteristics @ T_J = 25°C (unless otherwise stated)						
V _{(BR)DSS}	Drain-Source Breakdown Voltage	V _{GS} =0V I _D =250μA	30	--	--	V
I _{DSS}	Zero Gate Voltage Drain Current(T _A =25°C)	V _{DS} =30V, V _{GS} =0V	--	--	1	μA
	Zero Gate Voltage Drain Current(T _A =125°C)	V _{DS} =30V, V _{GS} =0V	--	--	100	uA
I _{GSS}	Gate-Body Leakage Current	V _{GS} =±20V, V _{DS} =0V	--	--	±100	nA
V _{GS(TH)}	Gate Threshold Voltage	V _{DS} =V _{GS} , I _D =250μA	0.5	0.9	1.5	V
R _{DS(ON)}	Drain-Source On-State Resistance ^②	V _{GS} =10V, I _D =4A	--	29	50	mΩ
R _{DS(ON)}	Drain-Source On-State Resistance ^②	V _{GS} =4.5V, I _D =3A	--	44	60	mΩ
Dynamic Electrical Characteristics @ T_J = 25°C (unless otherwise stated)						
C _{iss}	Input Capacitance	V _{DS} =24V, V _{GS} =0V, f=1MHz	--	300	--	pF
C _{oss}	Output Capacitance		--	44	--	pF
C _{rss}	Reverse Transfer Capacitance		--	38	--	pF
Q _g	Total Gate Charge	V _{DS} =24V I _D =2A, V _{GS} =10V	--	3.5	--	nC
Q _{gs}	Gate Source Charge		--	0.4	--	nC
Q _{gd}	Gate Drain Charge		--	1.7	--	nC
Switching Characteristics						
t _{d(on)}	Turn on Delay Time	V _{DD} =24V, I _D =5A, R _G =3.3Ω, V _{GS} =10V	--	2.2	--	ns
t _r	Turn on Rise Time		--	6.9	--	ns
t _{d(off)}	Turn Off Delay Time		-	15.5	--	ns
t _f	Turn Off Fall Time		--	4.5	--	ns
Source Drain Diode Characteristics						
I _{SD}	Source drain current(Body Diode)	T _A =25°C	--	--	1.8	A
V _{SD}	Forward on voltage ^②	T _J =25°C, I _{SD} =5A, V _{GS} =0V	--	--	1.2	V

Notes:

- ① Pulse width limited by maximum allowable junction temperature
- ② Pulse test ; Pulse width≤300μs, duty cycle≤2%.

Typical Characteristics

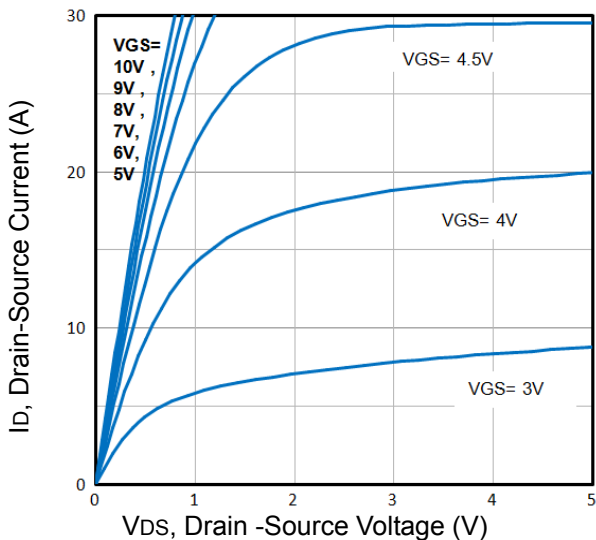

Fig1. Typical Output Characteristics

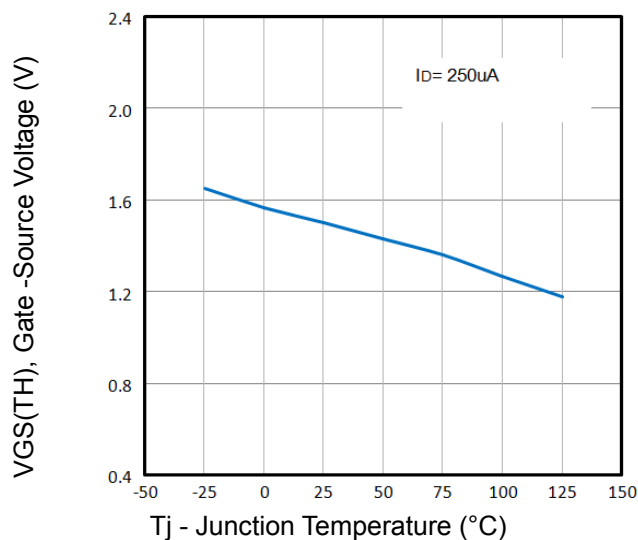

Fig2. Normalized Threshold Voltage Vs. Temperature

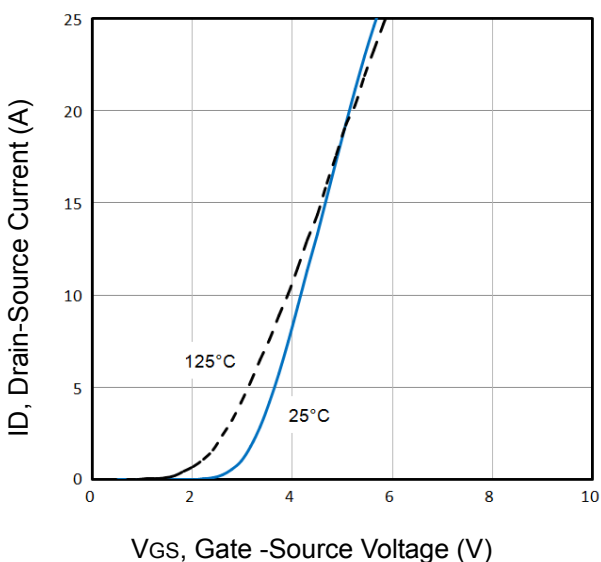

Fig3. Typical Transfer Characteristics

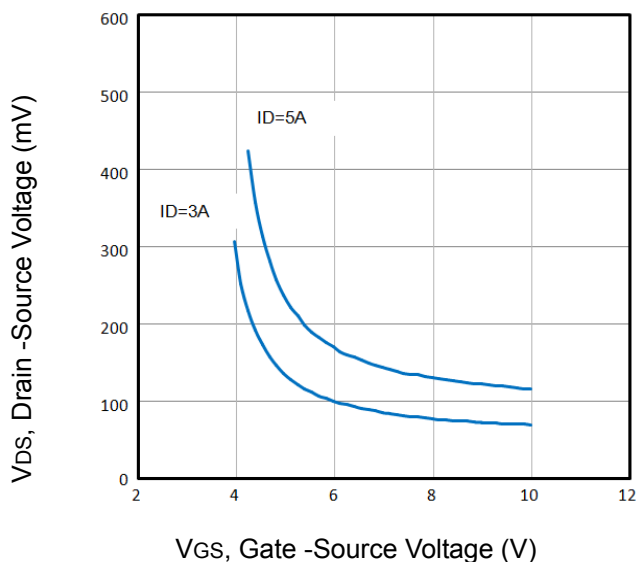

Fig4. Drain-Source Voltage vs Gate-Source Voltage

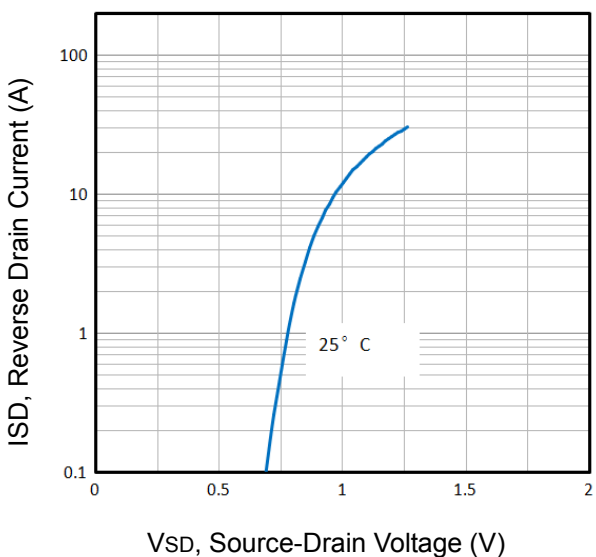

Fig5. Typical Source-Drain Diode Forward Voltage

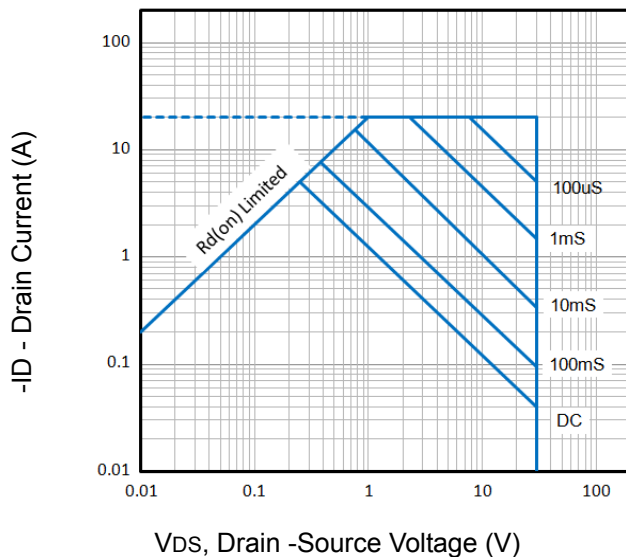

Fig6. Maximum Safe Operating Area

Typical Characteristics

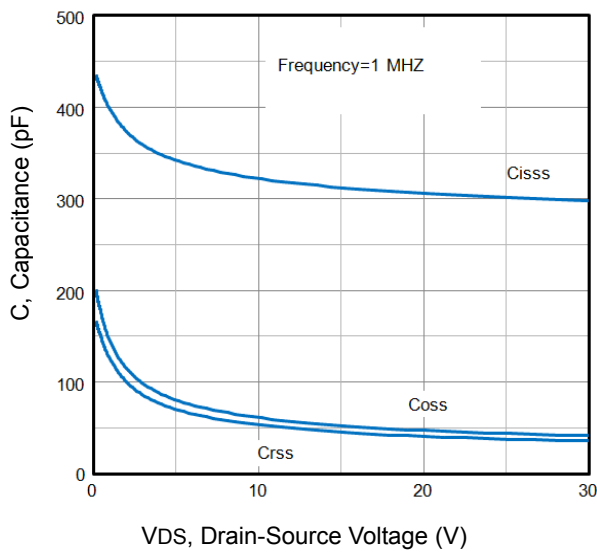

Fig7. Typical Capacitance Vs. Drain-Source Voltage

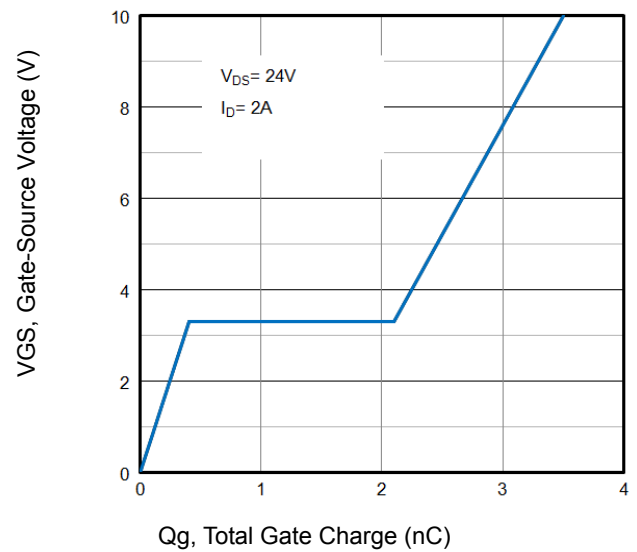

Fig8. Typical Gate Charge Vs. Gate-Source Voltage

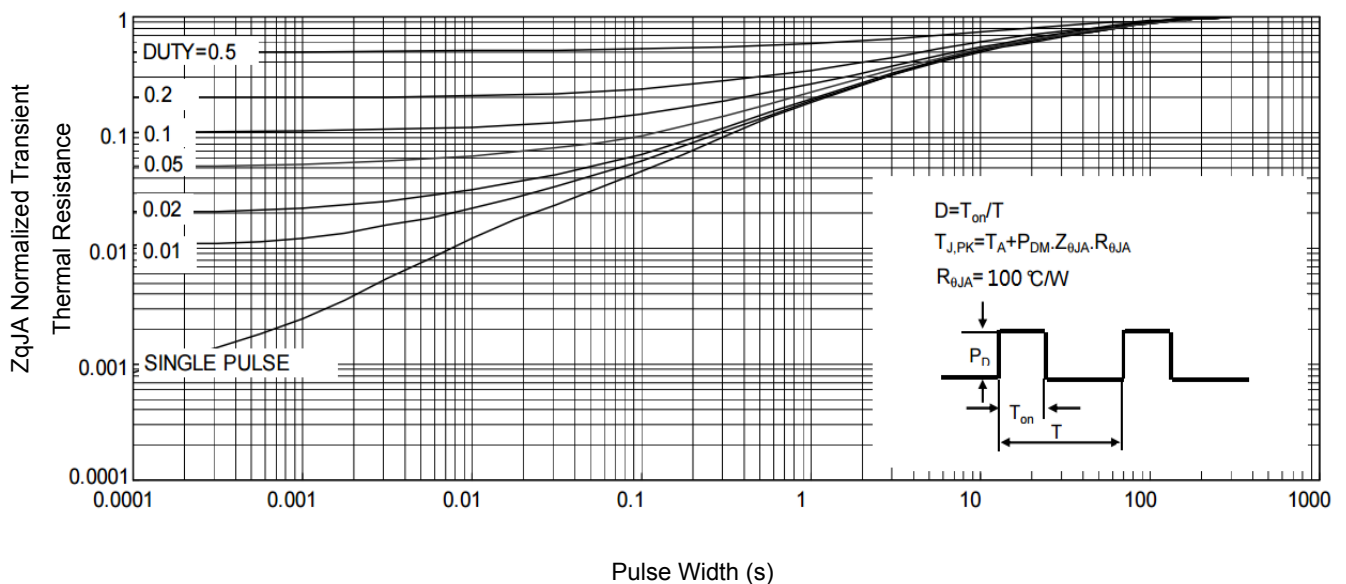

Fig9. Normalized Maximum Transient Thermal Impedance

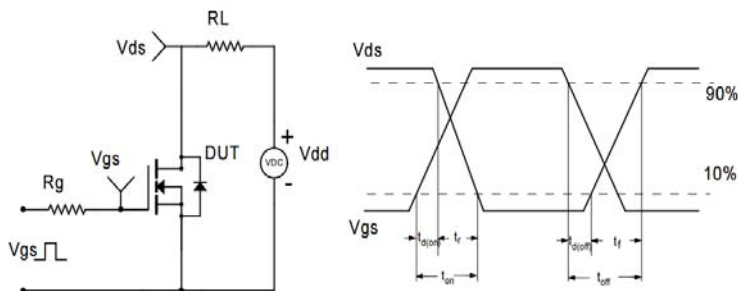
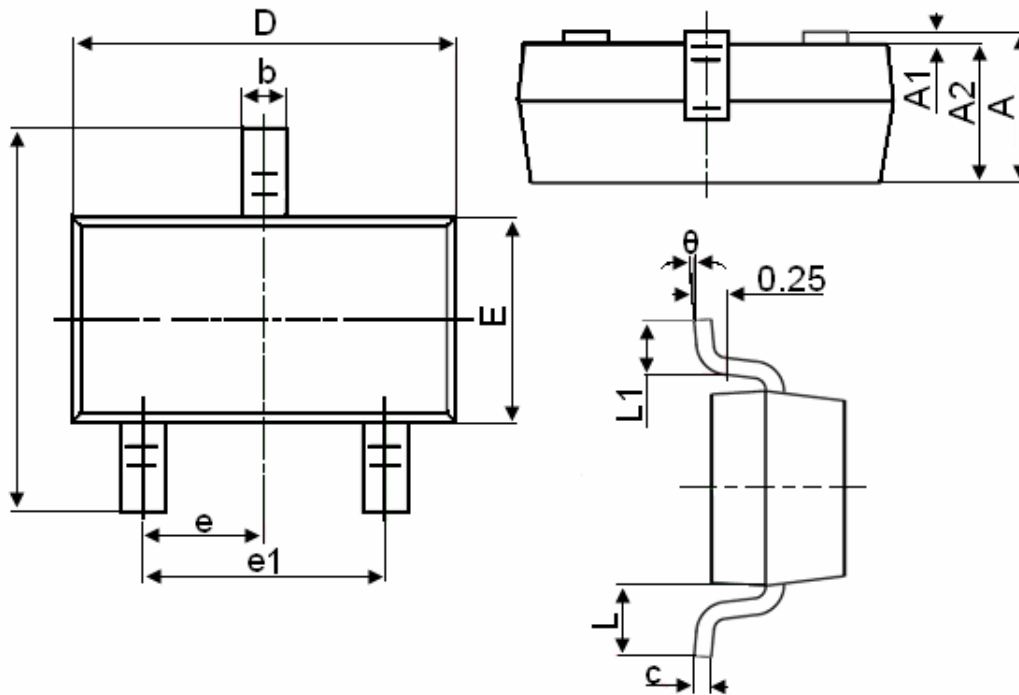

Fig10. Switching Time Test Circuit and waveforms

SOT-23 Package Information



Symbol	Dimensions in Millimeters	
	MIN.	MAX.
A	0.900	1.150
A1	0.000	0.100
A2	0.900	1.050
b	0.300	0.500
c	0.080	0.150
D	2.800	3.000
E	1.200	1.400
E1	2.250	2.550
e	0.950TYP	
e1	1.800	2.000
L	0.550REF	
L1	0.300	0.500
θ	0°	8°

单击下面可查看定价，库存，交付和生命周期等信息

[>>Slkor\(萨科微\)](#)