

## HIGH VOLTAGE AND HIGH CURRENT DARLINGTON TRANSISTOR ARRAY

### DESCRIPTION

The ULN2003 is a monolithic high voltage and high current Darlington transistor arrays. It consists of seven NPN darlington pairs that features high-voltage outputs with common-cathode clamp diode for switching inductive loads. The collector-current rating of a single darlington pair is 500mA. The darlington pairs may be paralleled for higher current capability. Applications include relay drivers, hammer drivers, lampdrivers, display drivers(LED gas discharge), line drivers, and logic buffers.

The ULN2003 has a 2.7kΩ series base resistor for each darlington pair for operation directly with TTL or 5V CMOS devices.

### FEATURES

- \* 500mA rated collector current(Single output)
- \* High-voltage outputs: 50V
- \* Inputs compatible with various types of logic.
- \* Relay driver application

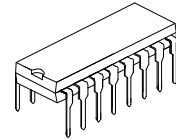

ULN2003AE DIP-16

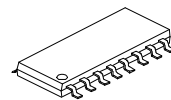

ULN2003AU SOP-16

### LOGIC DIAGRAM PAIR)

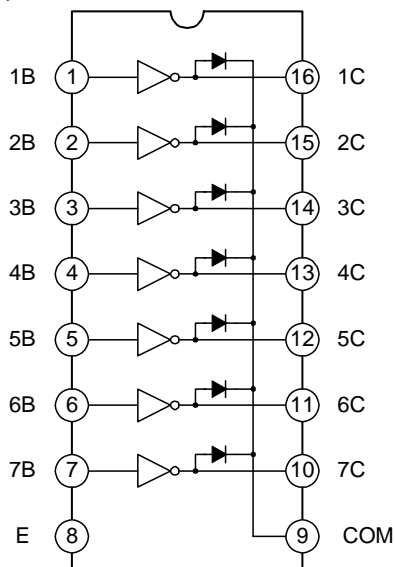

### SCHEMATIC(EACH DARLINGTON PAIR)

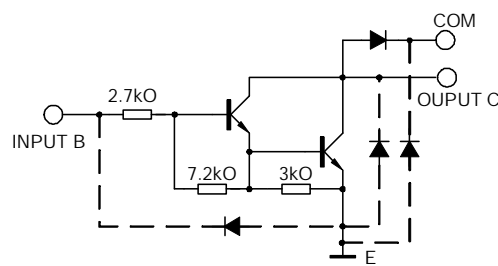

**ABSOLUTE MAXIMUM RATINGS**( $T_a=25^{\circ}\text{C}$ )

Characteristic	Symbol	Value	Unit
Collector-Emitter Voltage	VCE	50	V
Input Voltage	VI	30	V
Peak Collector Current	Io	500	mA
Total Emitter-terminal	IOK	500	mA
Power Dissipation	Pd	950 $T_{amb}=25^{\circ}\text{C}$	mW
		495 $T_{amb}<85^{\circ}\text{C}$	mW
Operating Temperature	Topr	-40~ +85	$^{\circ}\text{C}$
Storage Temperature	Tstg	-65 ~ +150	$^{\circ}\text{C}$

Note: All voltage values are with respect to the emitter/substrate terminal E, unless otherwise noted.

**ELECTRICAL CHARACTERISTICS**( $T_a=25^{\circ}\text{C}$ , unless otherwise specified)

Characteristic	Test Figure	Symbol	Test Conditions	Min	Typ	Max	Units
On-state Input Voltage	6	VI(ON)	VCE=2V, Ic=200mA			2.4	V
			VCE=2V, Ic=250mA			2.7	
			VCE=2V, Ic=300mA			3	
Collector-Emitter Saturation Voltage	5	VCE(SAT)	Ii=250 $\mu\text{A}$ , Ic=100mA		0.9	1.1	V
			Ii=350 $\mu\text{A}$ , Ic=200mA		1	1.3	
			Ii=500 $\mu\text{A}$ , Ic=350mA		1.2	1.6	
Collector Cutoff Current	1	ICEX	VCE=50V, Ii=0			50	$\mu\text{A}$
	2		VCE=50V, Ii=0, $T_a=70^{\circ}\text{C}$			100	
Clamp Forward Voltage	8	VF	IF=350mA		1.7	2	V
Off-state Input Current	3	Ii(OFF)	VCE=50V, Ic=500mA, $T_a=70^{\circ}\text{C}$	50	65		$\mu\text{A}$
Input Current	4	Ii	VI=3.85V		0.95	1.35	mA
Clamp Reverse Current	7	IR	VR=50V			50	$\mu\text{A}$
			VR=50V, $T_a=70^{\circ}\text{C}$			100	
Input Capacitance	--	CI	VI=0, f=1MHz		15	25	pF
Propagation delay time, low-to-high-level output	9	tPLH			0.25	1	$\mu\text{s}$
Propagation delay time, high-to-low-level output	9	tPHL			0.25	1	$\mu\text{s}$
High-level output Voltage after switching	10	VOH	Vs=50V, Io=300mA	Vs-20			mV

TEST CIRCUITS

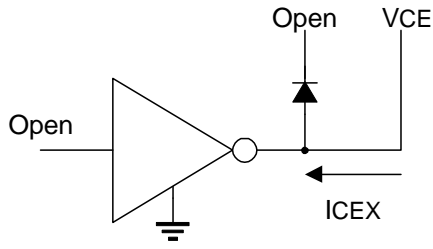

Figure 1 ICEX Test Circuit

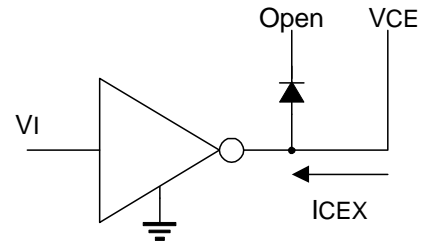

Figure 2 ICEX Test Circuit

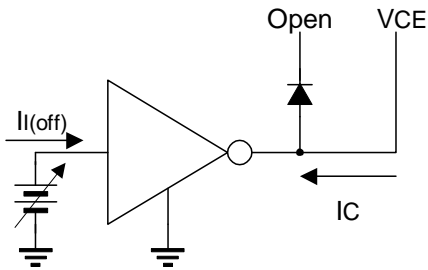

Figure 3 II(off) Test Circuit

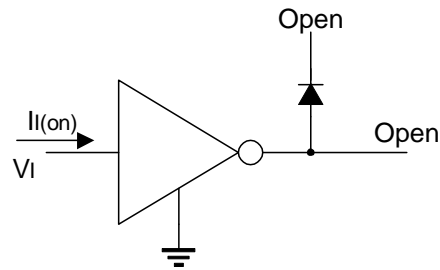
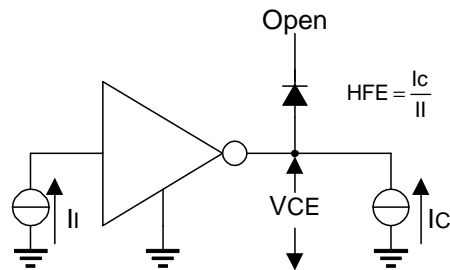

Figure 4 II(on) Test Circuit



Note: II is fixed for measuring VCE(sat), variable for measuring HFE.

Figure 5 HFE, VCE(sat) Test Circuit

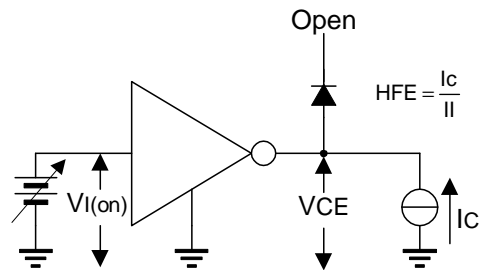

Figure 6 VI(on) Test Circuit

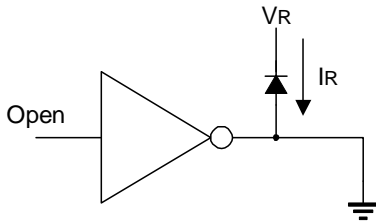

Figure 7 IR Test Circuit

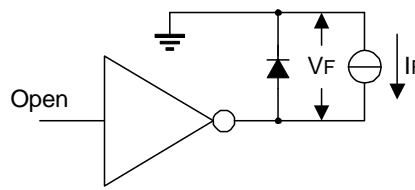

Figure 8 VF Test Circuit

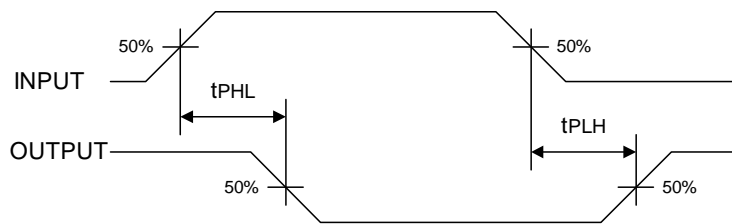
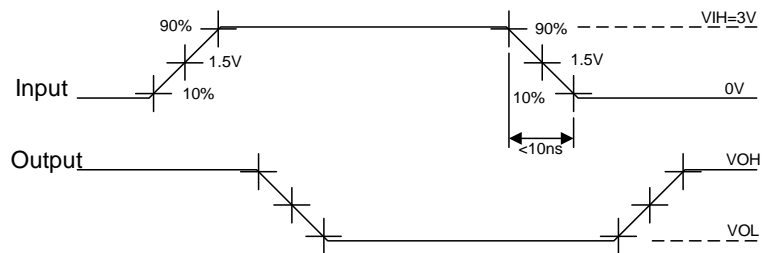
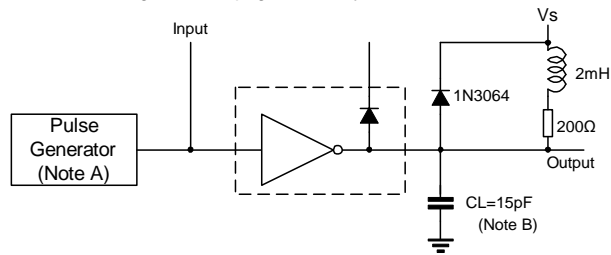

Figure 9. Propagation Delay Time Waveforms



Note: A. The Pulse generator has the following characteristics: PRR=12.5kHz,  $Z_o=50\Omega$

B. CL includes probe and jig capacitance.

Figure 10. Latch-up Test Circuit and Voltage Waveforms

TYPICAL PERFORMANCE CHARACTERISTICS

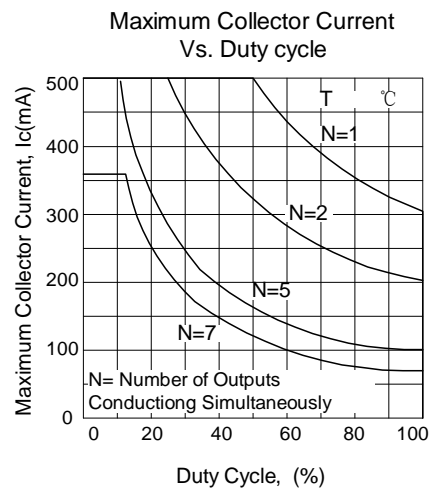
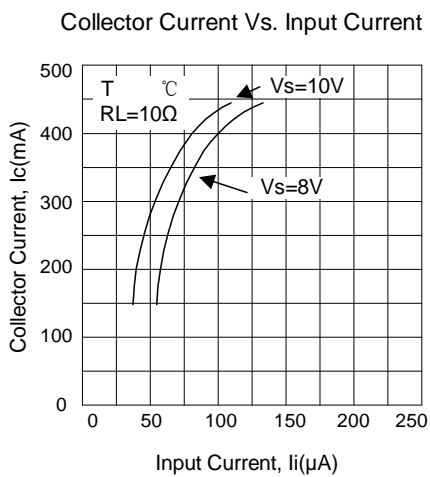
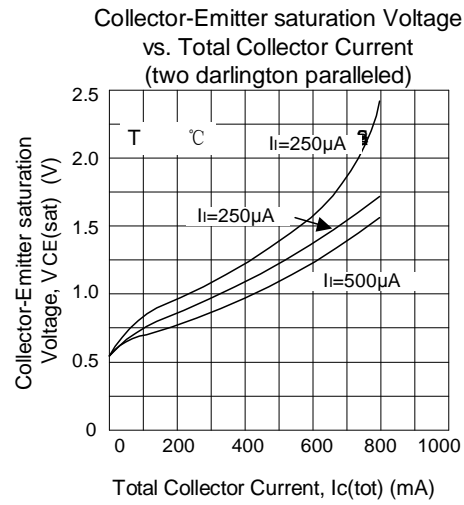
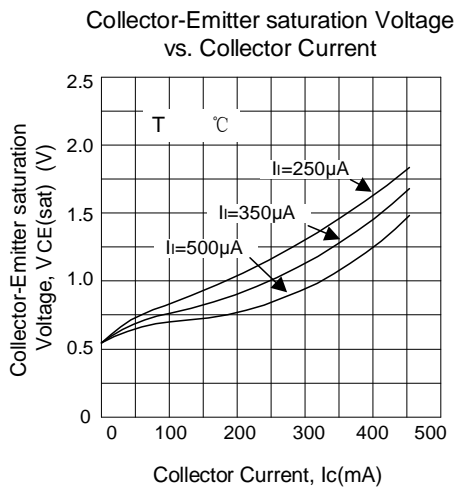

TYPICAL APPLICATION CIRCUIT

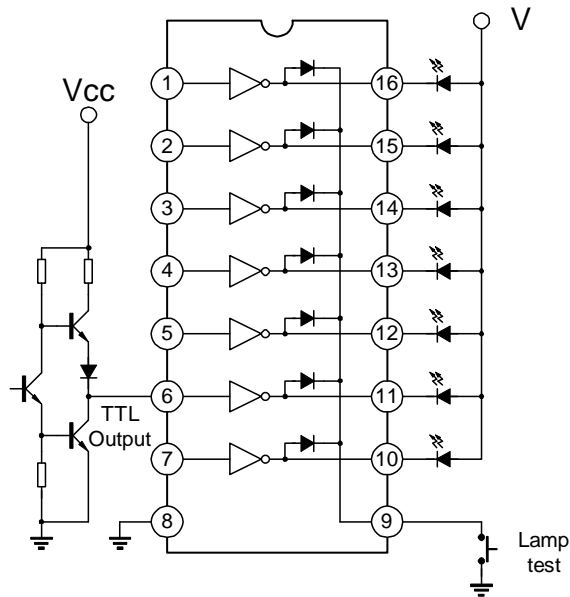

TTL to Load

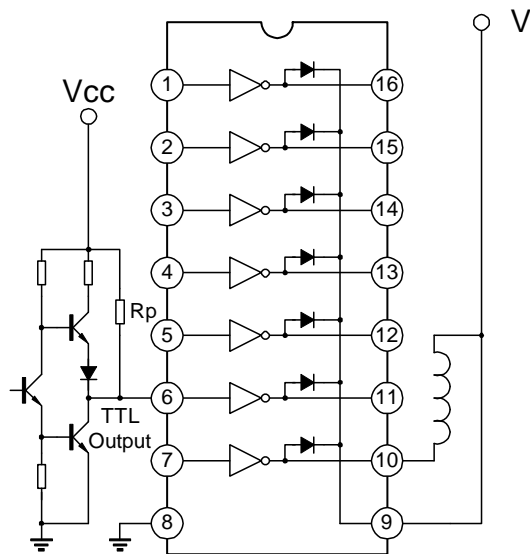

Use of pullup Resistor to increase drive Current

单击下面可查看定价，库存，交付和生命周期等信息

[>>Slkor\(萨科微\)](#)