

50 Ω nominal input / conjugate match balun to nRF51822-QFAA /AB/AC and nRF51422-QFAA/AB/AC with integrated filter

Datasheet – production data

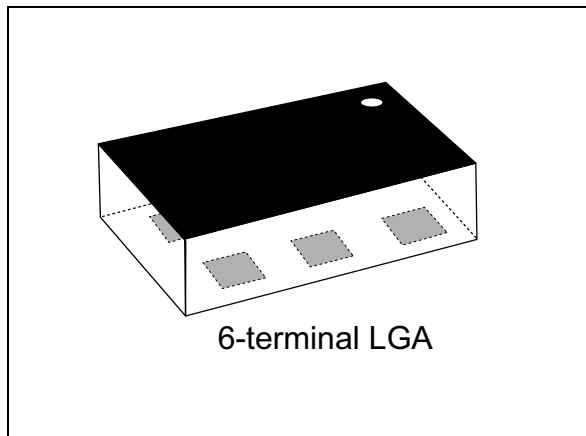

Features

- Low insertion loss
- Low amplitude imbalance
- Low phase imbalance
- Coated CSP on glass
- Small footprint: < 1.5 mm²

Benefits

- Very low profile
- High RF performance
- PCB space saving versus discrete solution
- BOM count reduction
- Efficient manufacturability

Applications

- 2.45 GHz balun with integrated matching network
- Matching optimized for following chipsets: nRF51822-QFAA/AB/AC and nRF51422-QFAA/AB/AC (see [Figure 19: nRF51822 and nRF51422 compatibility matrix](#)).

Description

STMicroelectronics BALF-NRF01E3 is an ultraminiature balun. The BALF-NRF01E3 integrates matching network in a monolithic glass substrate. Matching impedance has been customized for the nRF51822-QFAA/AB/AC and nRF51422-QFAA/AB/AC RF transceivers.

It uses STMicroelectronics IPD technology on non-conductive glass substrate which optimizes RF performance.

Figure 1. Pinout diagram (bottom view)

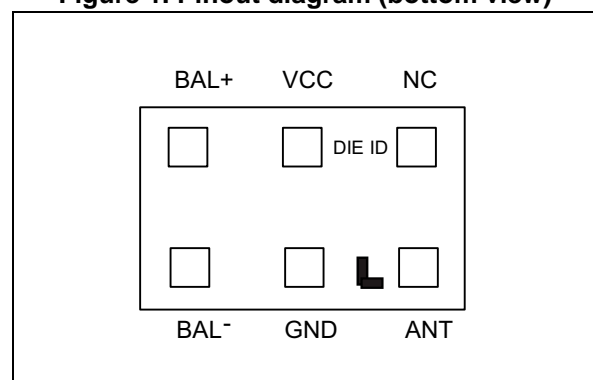

1 Characteristics

Table 1. Absolute maximum ratings (limiting values)

Symbol	Parameter	Value			Unit
		Min.	Typ.	Max.	
P _{IN}	Input power RF _{IN}		-	20	dBm
V _{ESD}	ESD ratings MIL STD883C (HBM: C = 100 pF, R = 1.5 k Ω , air discharge)	2000	-		V
	ESD ratings charge device model (JESD22-C101-C)	500	-		
	ESD ratings machine model (MM: C = 200 pF, R = 25 Ω , L = 500 nH)	500	-		
T _{OP}	Operating temperature	-40	-	+105	°C

Table 2. Electrical characteristics (T_{amb} = 25 °C)

Symbol	Parameter	Value			Unit
		Min.	Typ.	Max.	
Z _{OUT}	Nominal differential output impedance		Conjugate match to: – nRF51822-QFAA/AB/AC – nRF51422-QFAA/AB/AC		Ω
Z _{IN}	Nominal input impedance		50		Ω
F	Frequency range (bandwidth)	2400		2540	MHz
I _L	Insertion loss in bandwidth		2.2	2.7	dB
R _L	Return loss in band	14	15		dB
φ _{imb}	Phase imbalance	-10	4	10	°
A _{imb}	Amplitude imbalance	-1	0.3	1	dB
2f ₀	(4800-5080 MHz)	15.8	16.3		dB
3f ₀	(7200-7620 MHz)	22.7	24.1		dB

1.1 RF performance (T_{amb} = 25 °C)

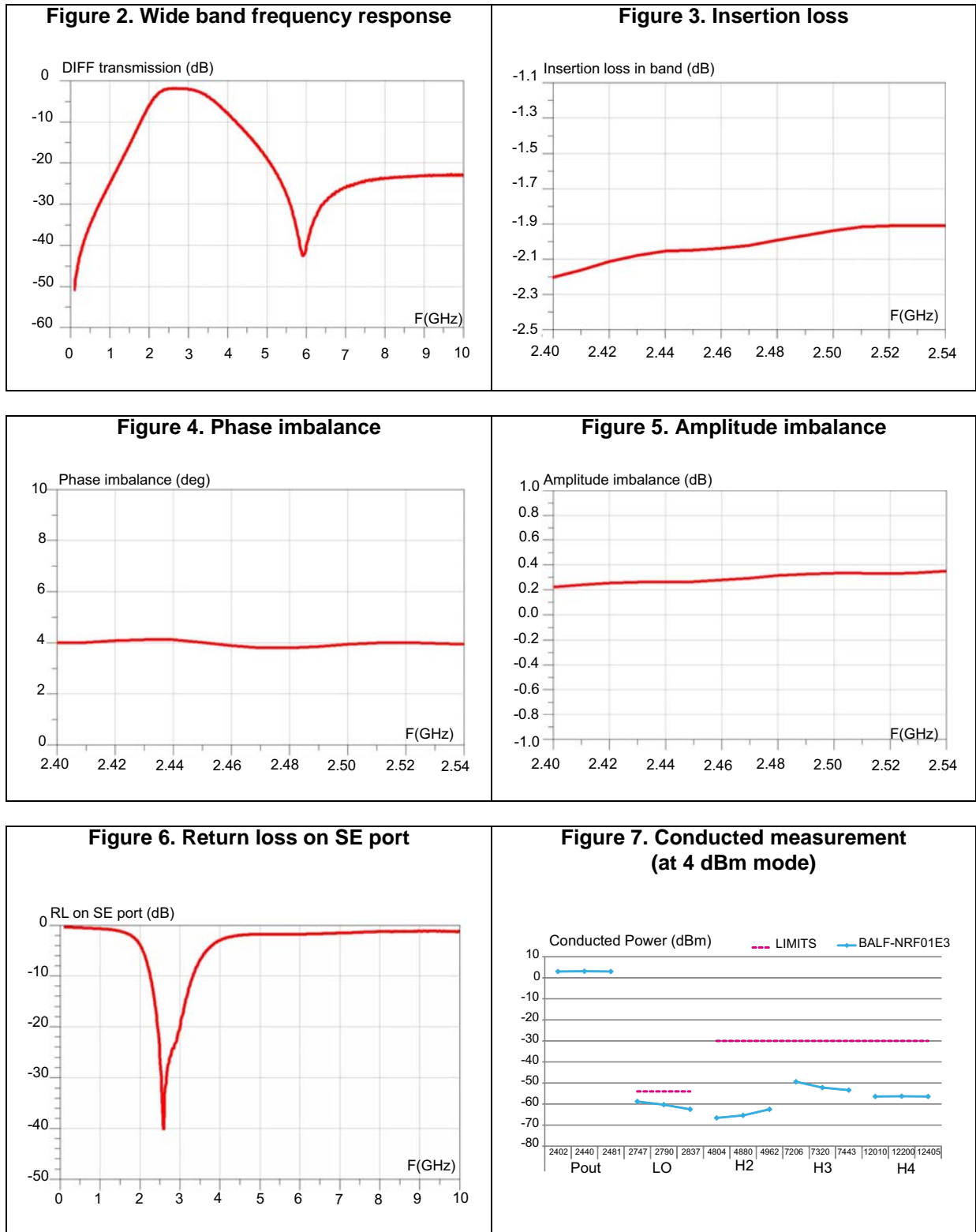

2 Application information

Figure 8. Application schematic

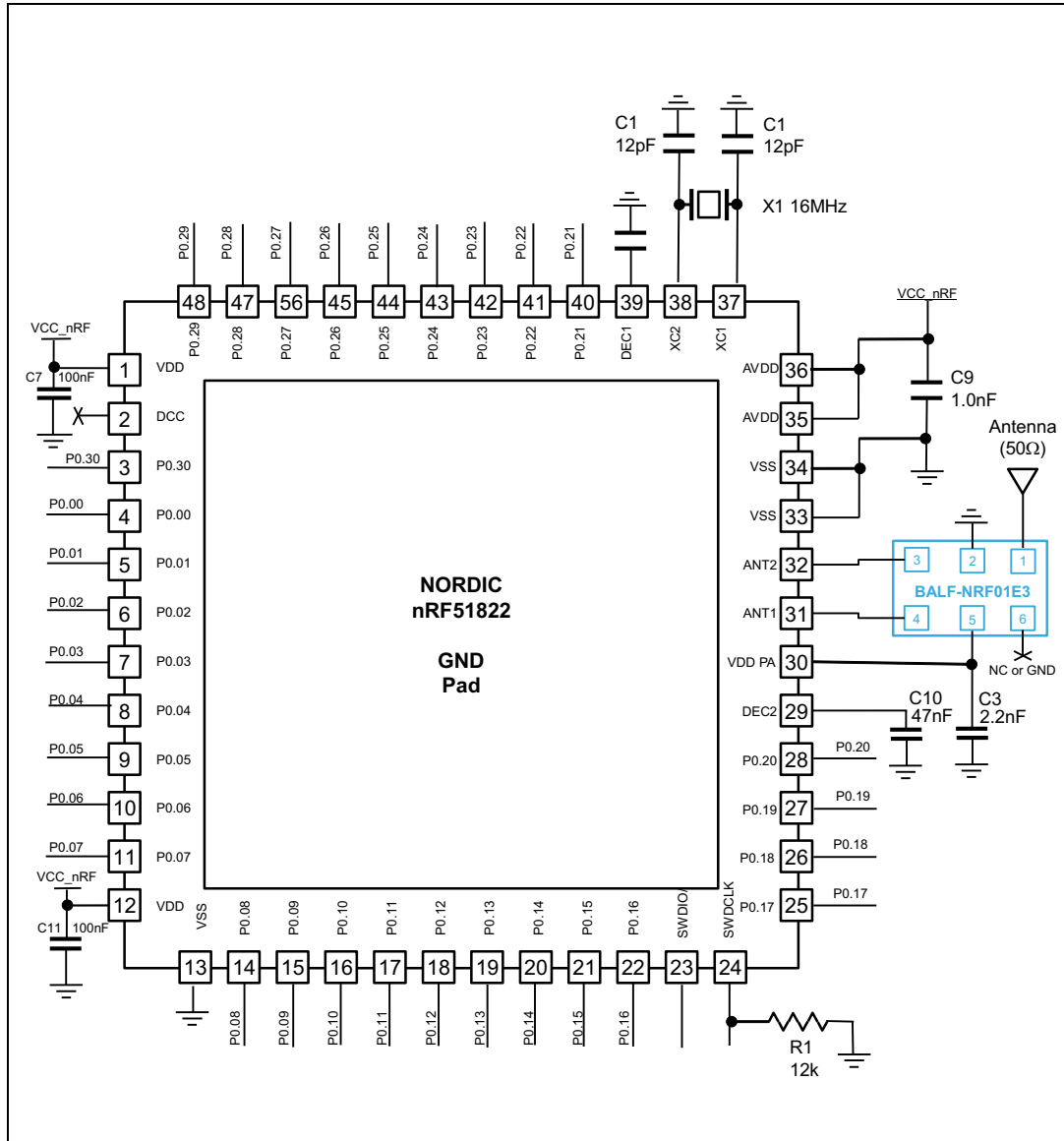

3 Package information

- Epoxy meets UL94, V0
- Lead-free package

In order to meet environmental requirements, ST offers these devices in different grades of ECOPACK[®] packages, depending on their level of environmental compliance. ECOPACK[®] specifications, grade definitions and product status are available at: www.st.com. ECOPACK[®] is an ST trademark.

3.1 LGA package information

Figure 9. LGA package outline

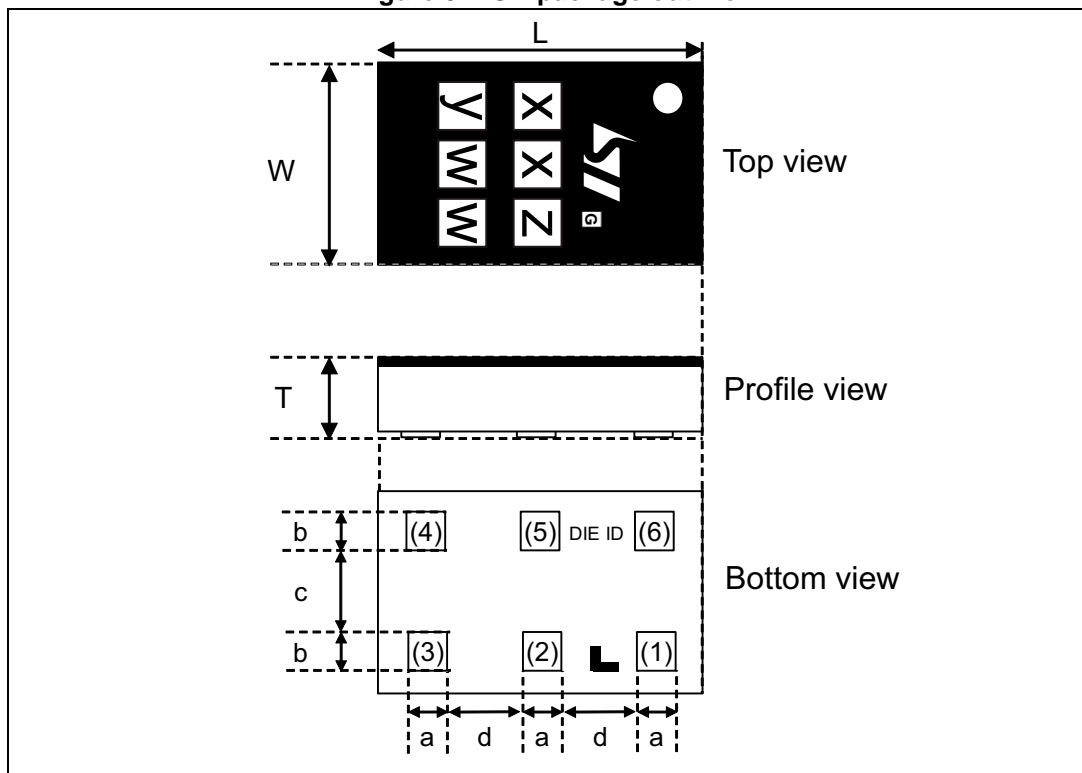

Table 3. LGA package mechanical data

Dim.	mm		
	Min.	Typ.	Max.
L	1.40	1.50	1.60
W	0.90	1.00	1.10
T	0.42	0.45	0.48
a	0.18	0.20	0.20
b	0.18	0.20	0.20
c	0.38	0.40	0.42
d	0.28	0.30	0.32

Figure 10. PCB layout recommendation

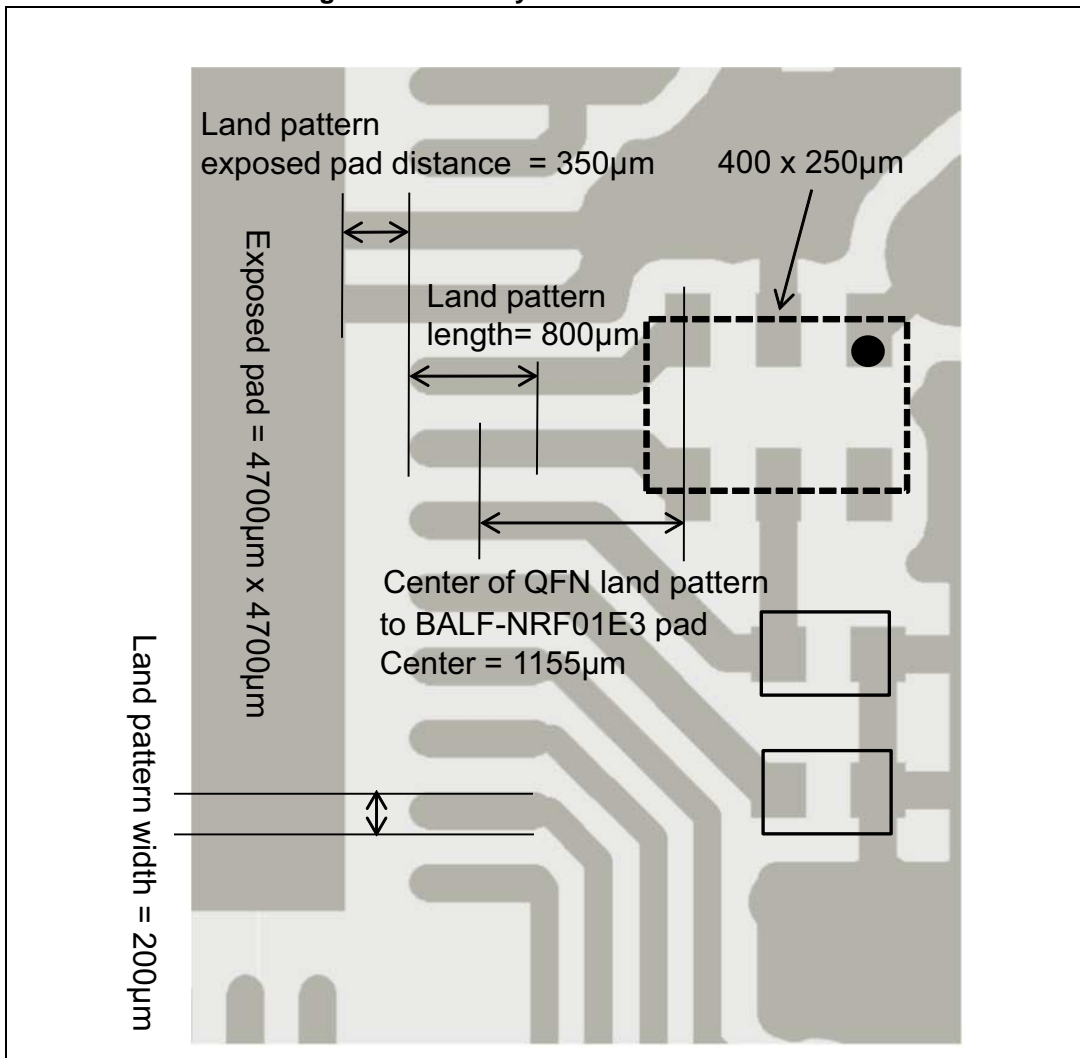
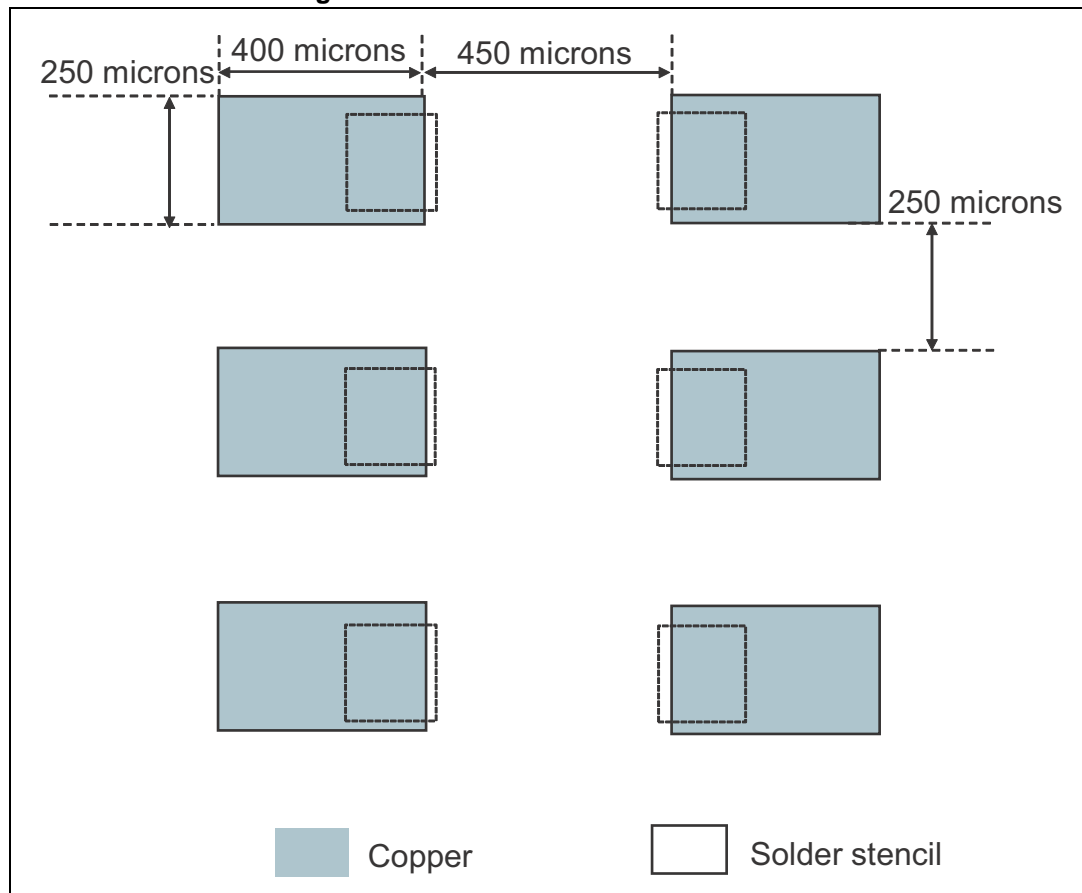

Figure 11. Solder-mask recommendation



Solder paste

- 100 μm solder stencil thickness is recommended.
- Halide-free flux qualification ROL0 according to ANSI/J-STD-004.
- “No Clean” solder paste is recommended.
- Offers a high tack force to resist component movement during high speed.
- Solder paste with fine particles: powder particle size is 20-45 μm .

Placement

- Manual positioning is not recommended.
- It is recommended to use the lead recognition capabilities of the placement system, not the outline centering.
- Standard tolerance of ± 0.05 mm is recommended.
- 3.5 N placement force is recommended. Too much placement force can lead to squeeze out solder paste and cause solder joints to short. Too low placement force can lead to insufficient contact between package and solder paste that could cause open solder joints or badly centered packages.
- To improve the package placement accuracy, a bottom side optical control should be performed with high resolution.
- For assembly, a strong PCB support is recommended (especially on low thickness PCB) during solder paste printing, pick and place and reflow soldering by using optimized tools.

Figure 12. Marking

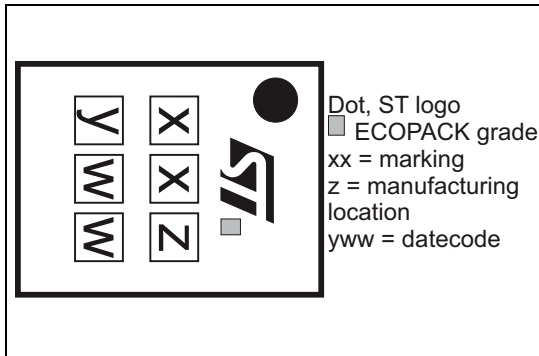

Figure 13. Pad bottom view

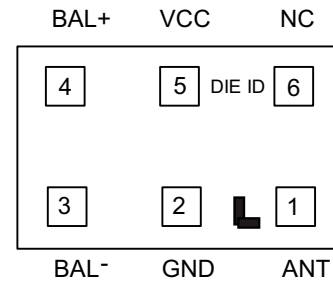
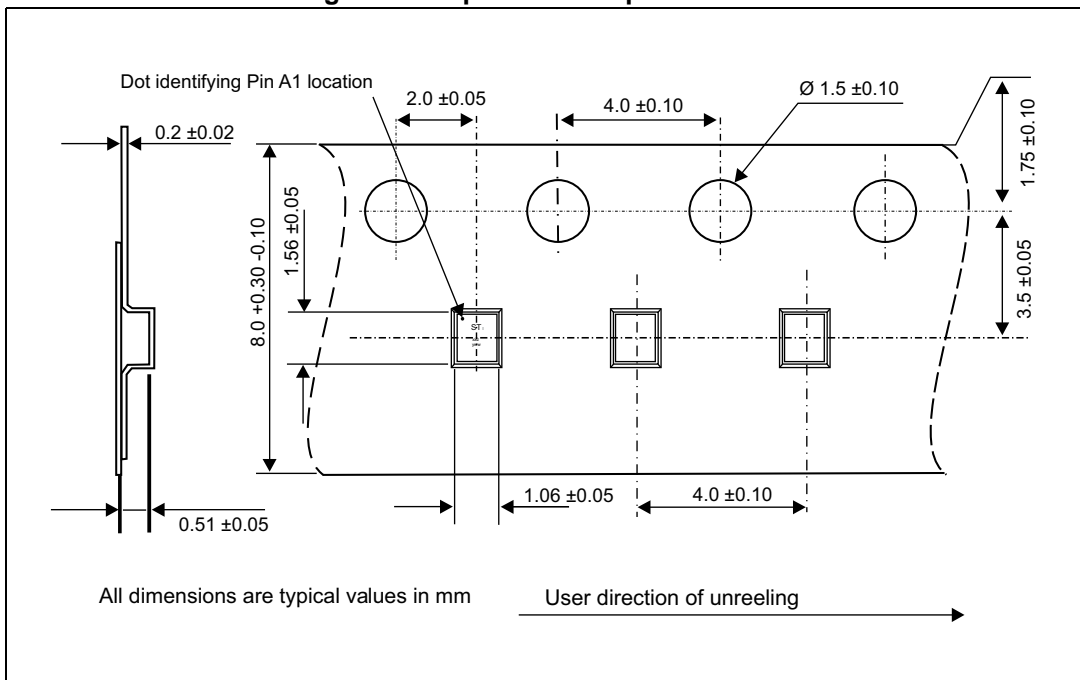

Table 4. Pad assignment details

LGA	Name	Description
6	NC	Not connected
5	VCC	Common collector voltage
4	BAL+	Balun positive output
3	BAL-	Balun negative output
2	GND	Ground
1	ANT	Antenna connection

Figure 14. Tape and reel specifications



Note: More information is available in the STMicroelectronics technical note: TN1197: "IPAD™, CSPG w/o bump: package description and recommendations for use".

Figure 15. Footprint - 3 mils stencil - non solder mask defined

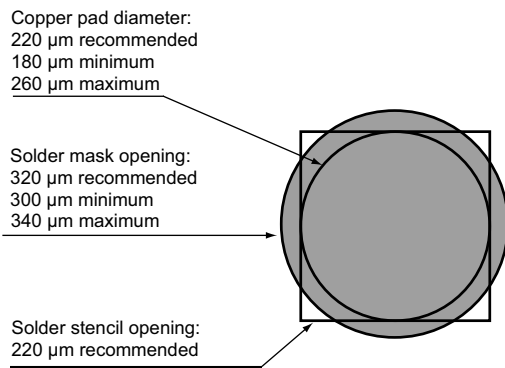

Figure 16. Footprint - 3 mils stencil - solder mask defined

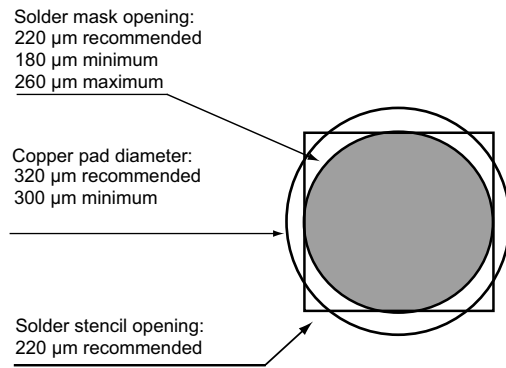

Figure 17. Footprint - 5 mils stencil - non solder mask defined

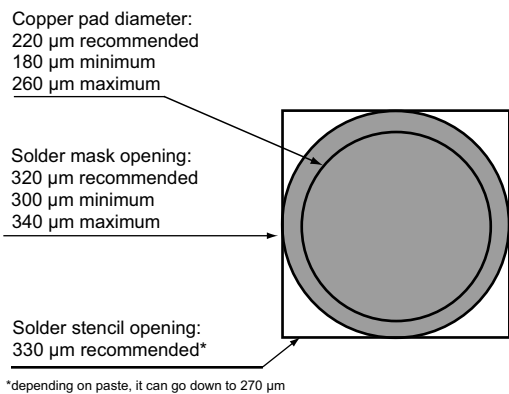

Figure 18. Footprint - 5 mils stencil - solder mask defined

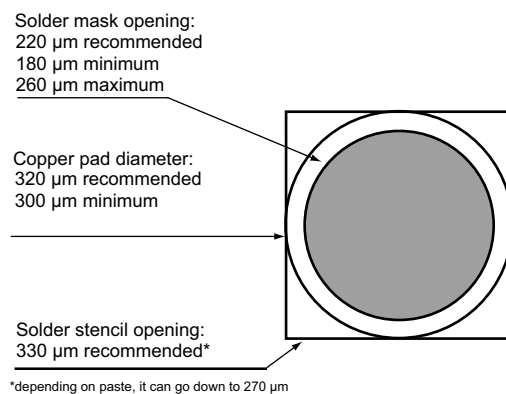

Figure 19. nRF51822 and nRF51422 compatibility matrix

RF IC Part Number	Package	ST Balun
nRF51822-QFAACA nRF51822-QFAAC0 nRF51422-QFAACA nRF51422-QFAAC0	QFN48	BAL-NRF01D3
nRF51822-QFABAA nRF51822-QFABA0		
nRF51822-QFAAG0 nRF51822-QFAAG1 nRF51822-QFAAG2 nRF51822-QFAAG3 nRF51422-QFAAE0 nRF51822-QFABB0 nRF51822-QFABB2 nRF51422-QFABA0	QFN48	BAL-NRF01D3 or BAL-NRF01E3
nRF51822-QFAAH0 nRF51822-QFAAH1 nRF51422-QFAAF0	QFN48	BAL-NRF01E3
nRF51822-QFABC0 nRF51422-QFABB0		NA
nRF51822-QFACA0 nRF51822-QFACA1 nRF51422-QFACA0		BAL-NRF01E3
nRF51822-CxAx nRF51422-CxAx	WLCSP	BAL-NRF02D3

4 Ordering information

Figure 20. Ordering information scheme

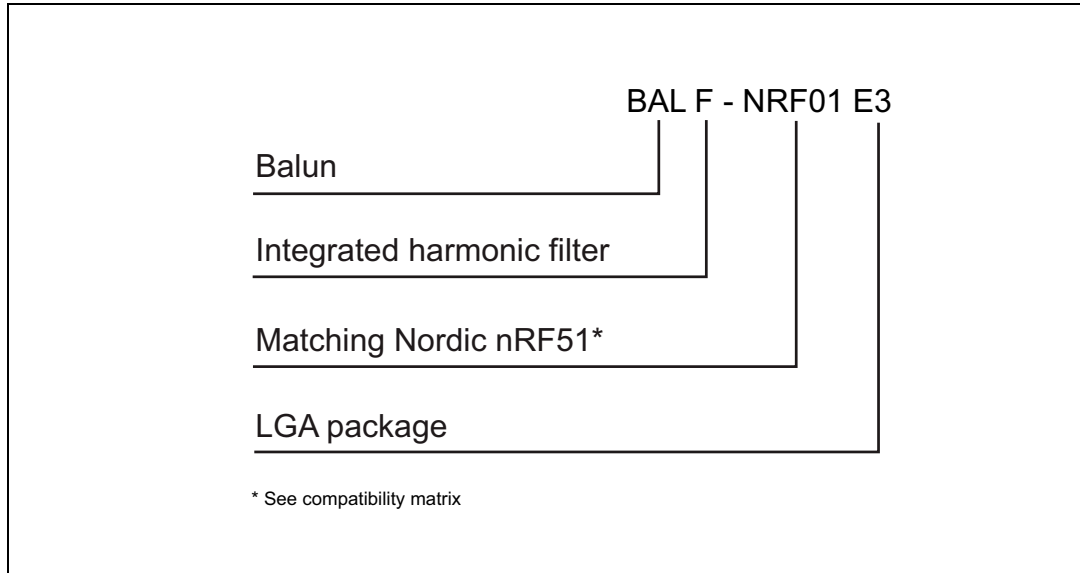

Table 5. Ordering information

Order code	Marking	Package	Weight	Base Qty	Delivery mode
BALF-NRF01E3	SYN	LGA	1.324 mg	5000	Tape and Reel(7")

5 Revision history

Table 6. Document revision history

Date	Revision	Changes
28-Nov-2014	1	Initial release.
07-Jul-2015	2	Updated Table 1.
22-Jan-2016	3	Updated document title and cover page. Updated Table 2 and Figure 8 and Figure 20 . Added Figure 19 . Format updated to current standard.

IMPORTANT NOTICE – PLEASE READ CAREFULLY

STMicroelectronics NV and its subsidiaries ("ST") reserve the right to make changes, corrections, enhancements, modifications, and improvements to ST products and/or to this document at any time without notice. Purchasers should obtain the latest relevant information on ST products before placing orders. ST products are sold pursuant to ST's terms and conditions of sale in place at the time of order acknowledgement.

Purchasers are solely responsible for the choice, selection, and use of ST products and ST assumes no liability for application assistance or the design of Purchasers' products.

No license, express or implied, to any intellectual property right is granted by ST herein.

Resale of ST products with provisions different from the information set forth herein shall void any warranty granted by ST for such product.

ST and the ST logo are trademarks of ST. All other product or service names are the property of their respective owners.

Information in this document supersedes and replaces information previously supplied in any prior versions of this document.

© 2016 STMicroelectronics – All rights reserved

单击下面可查看定价，库存，交付和生命周期等信息

[>>STMicroelectronics\(意法半导体\)](#)