

GPC Series Encapsulated Double Metallized, Size 2824 – 6560, 63 – 1,000 VDC

Overview

Film capacitor for surface mounting. Double sided metallized polyethylene naphthalate (PEN) as electrode. Clear PEN as dielectric. Rugged box encapsulation in self-extinguishing material meeting the requirements of UL 94 V-0. GPC capacitors meet the standards according to IEC 60384-23.

Applications

The GPC Series is designed for high frequency coupling and decoupling as well as general high speed applications requiring high dV/dt such as pulse operation in switched-mode power supply (SMPS). Not suitable for across-the-line application (see suppressor capacitors).

Benefits

- Rated voltage: 63 – 1,000 VDC
- Rated voltage: 40 – 350 VAC
- Capacitance range: 0.00047 – 1.0 μ F
- EIA size: 2824 – 6560
- Capacitance tolerance: \pm 10%, \pm 20%, other tolerances on request
- Climatic category: 55/125/56
- RoHS Compliant and lead-free terminations
- Operating temperature range of -55°C to $+125^{\circ}\text{C}$



Legacy Part Number System

GPC	7.3	471	K	63	K33	TR12
Series	Chip Length (mm)	Capacitance Code (pF)	Capacitance Tolerance	Rated Voltage (VDC)	Size Code	Packaging
Double Metallized PEN	7.3 10.2 12.7 16.5	First two digits indicate the two most significant digits of the capacitance value in picofarads. The third digit is the number of following zeros.	K = \pm 10% M = \pm 20% Other tolerances on request.	63 100 160 250 400 630 1,000	See Dimension Table	See Ordering Options Table

New KEMET Part Number System

F	117	S	L	471	K	063	V
Capacitor Class	Series	Chip Size	Size Code	Capacitance Code (pF)	Capacitance Tolerance	Rated Voltage (VDC)	Packaging
F = Film	Double Metallized PEN	S = 2824 W = 4036 Y = 5045 Z = 6560	See Dimension Table	First two digits indicate the two most significant digits of the capacitance value in picofarads. The third digit is the number of following zeros.	K = \pm 10% M = \pm 20% Other tolerances on request.	063 = 63 100 = 100 160 = 160 250 = 250 400 = 400 630 = 630 1K0 = 1,000	See Ordering Options Table

Ordering Options Table

Chip Size (EIA)	Packaging Type	KEMET Packaging Code	Legacy Packaging Code
2824	Standard Packaging Options		
	Tape & Reel (Standard Reel)	V	TR12
	Bulk (Bag)	A	BULK
4036	Standard Packaging Options		
	Tape & Reel (Standard Reel)	V	TR16
	Bulk (Bag)	A	BULK
	Other Packaging Options		
	Tape & Reel (Vertical Orientation Standard Reel)	Y	TV24
5045	Standard Packaging Options		
	Tape & Reel (Standard Reel)	V	TR24
	Bulk (Bag)	A	BULK
	Other Packaging Options		
	Tape & Reel (Vertical Orientation Standard Reel)	Y	TV24
6560	Standard Packaging Options		
	Tape & Reel (Standard Reel)	V	TR24
	Bulk (Bag)	A	BULK
	Other Packaging Options		
	Tape & Reel (Vertical Orientation Standard Reel)	Y	TV44

Dimensions – Millimeters

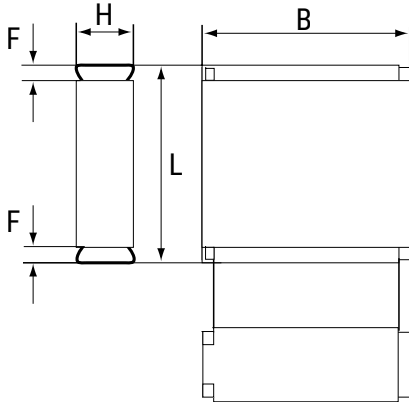

KEMET Size Code	Legacy Size Code	Chip Size (EIA)	B		H		L		F	
			Nominal	Tolerance	Nominal	Tolerance	Nominal	Tolerance	Nominal	Tolerance
SL	K33	2824	6.0	+/-0.2	3.0	+/-0.2	7.3	+/-0.2	0.5	Nominal
SP	K35	2824	6.0	+/-0.2	3.5	+/-0.2	7.3	+/-0.2	0.5	Nominal
ST	K37	2824	6.0	+/-0.2	4.5	+/-0.2	7.3	+/-0.2	0.5	Nominal
WP	A31	4036	9.1	+/-0.2	5.5	+/-0.2	10.2	+/-0.2	0.5	Nominal
YR	B31	5045	11.5	+/-0.2	6.5	+/-0.2	12.7	+/-0.2	0.5	Nominal
ZS	C31	6560	15	+/-0.2	7.0	+/-0.2	16.5	+/-0.2	0.5	Nominal

Environmental Compliance

All KEMET surface mount capacitors are RoHS Compliant.

Performance Characteristics

Rated Voltage (VDC)	63	100	160	250	400	630	1,000
Rated Voltage (VAC)	40	63	100	160	200	300	350
Capacitance Range (μF)	0.00047 – 1	0.00047 – 1	0.00047 – 0.68	0.00047 – 0.47	0.00047 – 0.22	0.00047 – 0.1	0.00047 – 0.68
Chip Size (EIA)	2824 – 6560						
Capacitance Tolerance	$\pm 10\%$, $\pm 20\%$, other tolerances on request						
Category Temperature Range	-55°C to $+125^\circ\text{C}$						
Rated Temperature	$+100^\circ\text{C}$						
Voltage Derating	The rated voltage should be decreased with $1.25\%/^\circ\text{C}$ from $+100^\circ\text{C}$ to $+125^\circ\text{C}$ and $1.5\%/^\circ\text{C}$ from $+125^\circ\text{C}$ to 175°C .						
Climatic Category	55/125/56						
Test Voltage	$1.6 \times V_R$, 60 seconds						
Insulation Resistance	Measured at $+20^\circ\text{C}$ According to IEC 60384-19						
	Minimum Value Between Terminals						
		$C \leq 0.33 \mu\text{F}$		$C > 0.33 \mu\text{F}$			
	$V_R \leq 100$	10,000 M Ω		5,000 M $\Omega \cdot \mu\text{F}$			
$V_R > 100$	30,000 M Ω		10,000 M $\Omega \cdot \mu\text{F}$				
Dissipation Factor	Maximum Values at $+23^\circ\text{C}$						
		$C \leq 0.1 \mu\text{F}$		$0.1 < C \leq 1 \mu\text{F}$		$C > 1 \mu\text{F}$	
	1 kHz	0.6%		0.6%		0.6%	
	10 kHz	1.0%		1.0%		1.2%	
100 kHz	2.0%		2.5%				
Pulse Rise Time	The capacitors can withstand an unlimited number of pulses with a dV/dt according to Table 1. For voltages (V) lower than the rated voltage (V_R), the specified dV/dt can be multiplied by V_R/V .						

Capacitance vs. Temperature

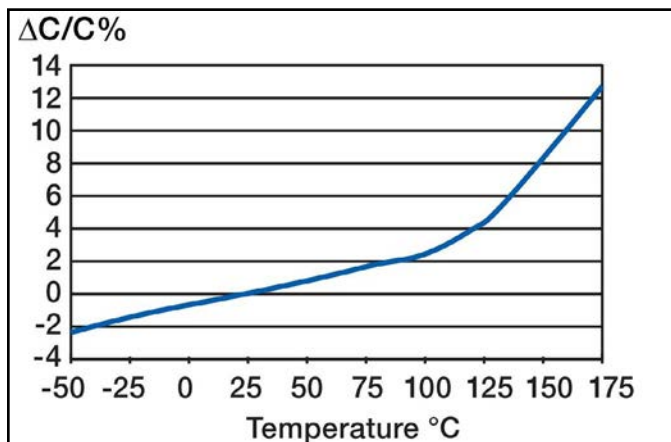

Dissipation Factor vs. Temperature

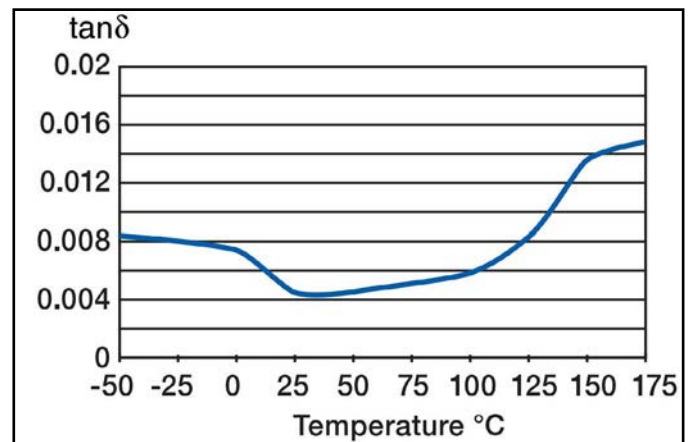

Table 1 – Ratings & Part Number Reference

VDC	VAC	Cap Value (μ F)	Size Code (New/Legacy)	Dimensions in mm			Chip Size	dV/dt (V/ μ s)	New KEMET Part Number	Legacy Part Number
				B	H	L				
63	40	0.00047	SL/K33	6.0	3.0	7.3	2824	400	F117SL471(1)063(2)	GPC7.3471(1)63K33(2)
63	40	0.00068	SL/K33	6.0	3.0	7.3	2824	400	F117SL681(1)063(2)	GPC7.3681(1)63K33(2)
63	40	0.0010	SL/K33	6.0	3.0	7.3	2824	400	F117SL102(1)063(2)	GPC7.3102(1)63K33(2)
63	40	0.0015	SL/K33	6.0	3.0	7.3	2824	400	F117SL152(1)063(2)	GPC7.3152(1)63K33(2)
63	40	0.0022	SL/K33	6.0	3.0	7.3	2824	400	F117SL222(1)063(2)	GPC7.3222(1)63K33(2)
63	40	0.0033	SL/K33	6.0	3.0	7.3	2824	400	F117SL332(1)063(2)	GPC7.3332(1)63K33(2)
63	40	0.0047	SL/K33	6.0	3.0	7.3	2824	400	F117SL472(1)063(2)	GPC7.3472(1)63K33(2)
63	40	0.0068	SL/K33	6.0	3.0	7.3	2824	400	F117SL682(1)063(2)	GPC7.3682(1)63K33(2)
63	40	0.010	SL/K33	6.0	3.0	7.3	2824	400	F117SL103(1)063(2)	GPC7.3103(1)63K33(2)
63	40	0.015	SL/K33	6.0	3.0	7.3	2824	400	F117SL153(1)063(2)	GPC7.3153(1)63K33(2)
63	40	0.022	SL/K33	6.0	3.0	7.3	2824	400	F117SL223(1)063(2)	GPC7.3223(1)63K33(2)
63	40	0.033	SL/K33	6.0	3.0	7.3	2824	400	F117SL333(1)063(2)	GPC7.3333(1)63K33(2)
63	40	0.047	SL/K33	6.0	3.0	7.3	2824	400	F117SL473(1)063(2)	GPC7.3473(1)63K33(2)
63	40	0.068	SP/K35	6.0	3.5	7.3	2824	400	F117SP683(1)063(2)	GPC7.3683(1)63K35(2)
63	40	0.10	ST/K37	6.0	4.5	7.3	2824	400	F117ST104(1)063(2)	GPC7.3104(1)63K37(2)
63	40	0.0068	WP/A31	9.1	5.5	10.2	4036	300	F117WP682(1)063(2)	GPC10.2682(1)63A31(2)
63	40	0.010	WP/A31	9.1	5.5	10.2	4036	300	F117WP103(1)063(2)	GPC10.2103(1)63A31(2)
63	40	0.015	WP/A31	9.1	5.5	10.2	4036	300	F117WP153(1)063(2)	GPC10.2153(1)63A31(2)
63	40	0.022	WP/A31	9.1	5.5	10.2	4036	300	F117WP223(1)063(2)	GPC10.2223(1)63A31(2)
63	40	0.027	WP/A31	9.1	5.5	10.2	4036	300	F117WP273(1)063(2)	GPC10.2273(1)63A31(2)
63	40	0.033	WP/A31	9.1	5.5	10.2	4036	300	F117WP333(1)063(2)	GPC10.2333(1)63A31(2)
63	40	0.047	WP/A31	9.1	5.5	10.2	4036	300	F117WP473(1)063(2)	GPC10.2473(1)63A31(2)
63	40	0.068	WP/A31	9.1	5.5	10.2	4036	300	F117WP683(1)063(2)	GPC10.2683(1)63A31(2)
63	40	0.10	WP/A31	9.1	5.5	10.2	4036	300	F117WP104(1)063(2)	GPC10.2104(1)63A31(2)
63	40	0.15	WP/A31	9.1	5.5	10.2	4036	300	F117WP154(1)063(2)	GPC10.2154(1)63A31(2)
63	40	0.22	WP/A31	9.1	5.5	10.2	4036	300	F117WP224(1)063(2)	GPC10.2224(1)63A31(2)
63	40	0.33	WP/A31	9.1	5.5	10.2	4036	300	F117WP334(1)063(2)	GPC10.2334(1)63A31(2)
63	40	0.47	YR/B31	11.5	6.5	12.7	5045	200	F117YR474(1)063(2)	GPC12.7474(1)63B31(2)
63	40	0.68	ZS/C31	15.0	7.0	16.5	6560	100	F117ZS684(1)063(2)	GPC16.5684(1)63C31(2)
63	40	1.0	ZS/C31	15.0	7.0	16.5	6560	100	F117ZS105(1)063(2)	GPC16.5105(1)63C31(2)
100	63	0.00047	SL/K33	6.0	3.0	7.3	2824	800	F117SL471(1)100(2)	GPC7.3471(1)100K33(2)
100	63	0.00068	SL/K33	6.0	3.0	7.3	2824	800	F117SL681(1)100(2)	GPC7.3681(1)100K33(2)
100	63	0.0010	SL/K33	6.0	3.0	7.3	2824	800	F117SL102(1)100(2)	GPC7.3102(1)100K33(2)
100	63	0.0015	SL/K33	6.0	3.0	7.3	2824	800	F117SL152(1)100(2)	GPC7.3152(1)100K33(2)
100	63	0.0022	SL/K33	6.0	3.0	7.3	2824	800	F117SL222(1)100(2)	GPC7.3222(1)100K33(2)
100	63	0.0033	SL/K33	6.0	3.0	7.3	2824	800	F117SL332(1)100(2)	GPC7.3332(1)100K33(2)
100	63	0.0047	SL/K33	6.0	3.0	7.3	2824	800	F117SL472(1)100(2)	GPC7.3472(1)100K33(2)
100	63	0.0068	SL/K33	6.0	3.0	7.3	2824	800	F117SL682(1)100(2)	GPC7.3682(1)100K33(2)
100	63	0.010	SL/K33	6.0	3.0	7.3	2824	800	F117SL103(1)100(2)	GPC7.3103(1)100K33(2)
100	63	0.015	SL/K33	6.0	3.0	7.3	2824	800	F117SL153(1)100(2)	GPC7.3153(1)100K33(2)
100	63	0.022	SL/K33	6.0	3.0	7.3	2824	800	F117SL223(1)100(2)	GPC7.3223(1)100K33(2)
100	63	0.033	SP/K35	6.0	3.5	7.3	2824	800	F117SP333(1)100(2)	GPC7.3333(1)100K35(2)
100	63	0.047	ST/K37	6.0	4.5	7.3	2824	800	F117ST473(1)100(2)	GPC7.3473(1)100K37(2)
100	63	0.0068	WP/A31	9.1	5.5	10.2	4036	600	F117WP682(1)100(2)	GPC10.2682(1)100A31(2)
100	63	0.010	WP/A31	9.1	5.5	10.2	4036	600	F117WP103(1)100(2)	GPC10.2103(1)100A31(2)
100	63	0.015	WP/A31	9.1	5.5	10.2	4036	600	F117WP153(1)100(2)	GPC10.2153(1)100A31(2)
100	63	0.022	WP/A31	9.1	5.5	10.2	4036	600	F117WP223(1)100(2)	GPC10.2223(1)100A31(2)
100	63	0.027	WP/A31	9.1	5.5	10.2	4036	600	F117WP273(1)100(2)	GPC10.2273(1)100A31(2)
100	63	0.033	WP/A31	9.1	5.5	10.2	4036	600	F117WP333(1)100(2)	GPC10.2333(1)100A31(2)
100	63	0.047	WP/A31	9.1	5.5	10.2	4036	600	F117WP473(1)100(2)	GPC10.2473(1)100A31(2)
100	63	0.068	WP/A31	9.1	5.5	10.2	4036	600	F117WP683(1)100(2)	GPC10.2683(1)100A31(2)
100	63	0.10	WP/A31	9.1	5.5	10.2	4036	600	F117WP104(1)100(2)	GPC10.2104(1)100A31(2)
100	63	0.15	WP/A31	9.1	5.5	10.2	4036	600	F117WP154(1)100(2)	GPC10.2154(1)100A31(2)
100	63	0.22	YR/B31	11.5	6.5	12.7	5045	400	F117YR224(1)100(2)	GPC12.7224(1)100B31(2)
100	63	0.33	YR/B31	11.5	6.5	12.7	5045	400	F117YR334(1)100(2)	GPC12.7334(1)100B31(2)
100	63	0.47	ZS/C31	15.0	7.0	16.5	6560	150	F117ZS474(1)100(2)	GPC16.5474(1)100C31(2)
100	63	0.68	ZS/C31	15.0	7.0	16.5	6560	150	F117ZS684(1)100(2)	GPC16.5684(1)100C31(2)
100	63	1.0	ZS/C31	15.0	7.0	16.5	6560	150	F117ZS105(1)100(2)	GPC16.5105(1)100C31(2)
160	100	0.00047	SL/K33	6.0	3.0	7.3	2824	1000	F117SL471(1)160(2)	GPC7.3471(1)160K33(2)
VDC	VAC	Capacitance Value (μ F)	Size Code (New/Legacy)	B (mm)	H (mm)	L (mm)	Chip Size	dV/dt (V/ μ s)	New KEMET Part Number	Legacy Part Number

(1) K = \pm 10%, M = \pm 20%, other tolerances on request.

(2) Insert ordering code for lead type and packaging. See Ordering Options Table for available options.

Table 1 – Ratings & Part Number Reference cont'd

VDC	VAC	Cap Value (μ F)	Size Code (New/Legacy)	Dimensions in mm			Chip Size	dV/dt (V/ μ s)	New KEMET Part Number	Legacy Part Number
				B	H	L				
160	100	0.00068	SL/K33	6.0	3.0	7.3	2824	1000	F117SL681(1)160(2)	GPC7.3681(1)160K33(2)
160	100	0.0010	SL/K33	6.0	3.0	7.3	2824	1000	F117SL102(1)160(2)	GPC7.3102(1)160K33(2)
160	100	0.0015	SL/K33	6.0	3.0	7.3	2824	1000	F117SL152(1)160(2)	GPC7.3152(1)160K33(2)
160	100	0.0022	SL/K33	6.0	3.0	7.3	2824	1000	F117SL222(1)160(2)	GPC7.3222(1)160K33(2)
160	100	0.0033	SL/K33	6.0	3.0	7.3	2824	1000	F117SL332(1)160(2)	GPC7.3332(1)160K33(2)
160	100	0.0047	SL/K33	6.0	3.0	7.3	2824	1000	F117SL472(1)160(2)	GPC7.3472(1)160K33(2)
160	100	0.0068	SL/K33	6.0	3.0	7.3	2824	1000	F117SL682(1)160(2)	GPC7.3682(1)160K33(2)
160	100	0.010	SL/K33	6.0	3.0	7.3	2824	1000	F117SL103(1)160(2)	GPC7.3103(1)160K33(2)
160	100	0.015	SL/K33	6.0	3.0	7.3	2824	1000	F117SL153(1)160(2)	GPC7.3153(1)160K33(2)
160	100	0.022	SP/K35	6.0	3.5	7.3	2824	1000	F117SP223(1)160(2)	GPC7.3223(1)160K35(2)
160	100	0.033	ST/K37	6.0	4.5	7.3	2824	1000	F117ST333(1)160(2)	GPC7.3333(1)160K37(2)
160	100	0.0068	WP/A31	9.1	5.5	10.2	4036	800	F117WP682(1)160(2)	GPC10.2682(1)160A31(2)
160	100	0.010	WP/A31	9.1	5.5	10.2	4036	800	F117WP103(1)160(2)	GPC10.2103(1)160A31(2)
160	100	0.015	WP/A31	9.1	5.5	10.2	4036	800	F117WP153(1)160(2)	GPC10.2153(1)160A31(2)
160	100	0.022	WP/A31	9.1	5.5	10.2	4036	800	F117WP223(1)160(2)	GPC10.2223(1)160A31(2)
160	100	0.027	WP/A31	9.1	5.5	10.2	4036	800	F117WP273(1)160(2)	GPC10.2273(1)160A31(2)
160	100	0.033	WP/A31	9.1	5.5	10.2	4036	800	F117WP333(1)160(2)	GPC10.2333(1)160A31(2)
160	100	0.047	WP/A31	9.1	5.5	10.2	4036	800	F117WP473(1)160(2)	GPC10.2473(1)160A31(2)
160	100	0.068	WP/A31	9.1	5.5	10.2	4036	800	F117WP683(1)160(2)	GPC10.2683(1)160A31(2)
160	100	0.10	WP/A31	9.1	5.5	10.2	4036	800	F117WP104(1)160(2)	GPC10.2104(1)160A31(2)
160	100	0.15	YR/B31	11.5	6.5	12.7	5045	600	F117YR154(1)160(2)	GPC12.7154(1)160B31(2)
160	100	0.22	YR/B31	11.5	6.5	12.7	5045	600	F117YR224(1)160(2)	GPC12.7224(1)160B31(2)
160	100	0.33	ZS/C31	15.0	7.0	16.5	6560	250	F117ZS334(1)160(2)	GPC16.5334(1)160C31(2)
160	100	0.47	ZS/C31	15.0	7.0	16.5	6560	250	F117ZS474(1)160(2)	GPC16.5474(1)160C31(2)
160	100	0.68	ZS/C31	15.0	7.0	16.5	6560	250	F117ZS684(1)160(2)	GPC16.5684(1)160C31(2)
250	160	0.00047	SL/K33	6.0	3.0	7.3	2824	1200	F117SL471(1)250(2)	GPC7.3471(1)250K33(2)
250	160	0.00068	SL/K33	6.0	3.0	7.3	2824	1200	F117SL681(1)250(2)	GPC7.3681(1)250K33(2)
250	160	0.0010	SL/K33	6.0	3.0	7.3	2824	1200	F117SL102(1)250(2)	GPC7.3102(1)250K33(2)
250	160	0.0015	SL/K33	6.0	3.0	7.3	2824	1200	F117SL152(1)250(2)	GPC7.3152(1)250K33(2)
250	160	0.0022	SL/K33	6.0	3.0	7.3	2824	1200	F117SL222(1)250(2)	GPC7.3222(1)250K33(2)
250	160	0.0033	SL/K33	6.0	3.0	7.3	2824	1200	F117SL332(1)250(2)	GPC7.3332(1)250K33(2)
250	160	0.0047	SL/K33	6.0	3.0	7.3	2824	1200	F117SL472(1)250(2)	GPC7.3472(1)250K33(2)
250	160	0.0068	SL/K33	6.0	3.0	7.3	2824	1200	F117SL682(1)250(2)	GPC7.3682(1)250K33(2)
250	160	0.010	SL/K33	6.0	3.0	7.3	2824	1200	F117SL103(1)250(2)	GPC7.3103(1)250K33(2)
250	160	0.015	SP/K35	6.0	3.5	7.3	2824	1200	F117SP153(1)250(2)	GPC7.3153(1)250K35(2)
250	160	0.022	ST/K37	6.0	4.5	7.3	2824	1200	F117ST223(1)250(2)	GPC7.3223(1)250K37(2)
250	160	0.0068	WP/A31	9.1	5.5	10.2	4036	1000	F117WP682(1)250(2)	GPC10.2682(1)250A31(2)
250	160	0.010	WP/A31	9.1	5.5	10.2	4036	1000	F117WP103(1)250(2)	GPC10.2103(1)250A31(2)
250	160	0.015	WP/A31	9.1	5.5	10.2	4036	1000	F117WP153(1)250(2)	GPC10.2153(1)250A31(2)
250	160	0.022	WP/A31	9.1	5.5	10.2	4036	1000	F117WP223(1)250(2)	GPC10.2223(1)250A31(2)
250	160	0.027	WP/A31	9.1	5.5	10.2	4036	1000	F117WP273(1)250(2)	GPC10.2273(1)250A31(2)
250	160	0.033	WP/A31	9.1	5.5	10.2	4036	1000	F117WP333(1)250(2)	GPC10.2333(1)250A31(2)
250	160	0.047	WP/A31	9.1	5.5	10.2	4036	1000	F117WP473(1)250(2)	GPC10.2473(1)250A31(2)
250	160	0.068	WP/A31	9.1	5.5	10.2	4036	1000	F117WP683(1)250(2)	GPC10.2683(1)250A31(2)
250	160	0.10	YR/B31	11.5	6.5	12.7	5045	700	F117YR104(1)250(2)	GPC12.7104(1)250B31(2)
250	160	0.15	YR/B31	11.5	6.5	12.7	5045	700	F117YR154(1)250(2)	GPC12.7154(1)250B31(2)
250	160	0.22	ZS/C31	15.0	7.0	16.5	6560	350	F117ZS224(1)250(2)	GPC16.5224(1)250C31(2)
250	160	0.33	ZS/C31	15.0	7.0	16.5	6560	350	F117ZS334(1)250(2)	GPC16.5334(1)250C31(2)
250	160	0.47	ZS/C31	15.0	7.0	16.5	6560	350	F117ZS474(1)250(2)	GPC16.5474(1)250C31(2)
400	200	0.00047	SL/K33	6.0	3.0	7.3	2824	1600	F117SL471(1)400(2)	GPC7.3471(1)400K33(2)
400	200	0.00068	SL/K33	6.0	3.0	7.3	2824	1600	F117SL681(1)400(2)	GPC7.3681(1)400K33(2)
400	200	0.0010	SL/K33	6.0	3.0	7.3	2824	1600	F117SL102(1)400(2)	GPC7.3102(1)400K33(2)
400	200	0.0015	SL/K33	6.0	3.0	7.3	2824	1600	F117SL152(1)400(2)	GPC7.3152(1)400K33(2)
400	200	0.0022	SL/K33	6.0	3.0	7.3	2824	1600	F117SL222(1)400(2)	GPC7.3222(1)400K33(2)
400	200	0.0033	SL/K33	6.0	3.0	7.3	2824	1600	F117SL332(1)400(2)	GPC7.3332(1)400K33(2)
400	200	0.0047	SL/K33	6.0	3.0	7.3	2824	1600	F117SL472(1)400(2)	GPC7.3472(1)400K33(2)
400	200	0.0068	SP/K35	6.0	3.5	7.3	2824	1600	F117SP682(1)400(2)	GPC7.3682(1)400K35(2)
400	200	0.010	ST/K37	6.0	4.5	7.3	2824	1600	F117ST103(1)400(2)	GPC7.3103(1)400K37(2)
400	200	0.0068	WP/A31	9.1	5.5	10.2	4036	1300	F117WP682(1)400(2)	GPC10.2682(1)400A31(2)
VDC	VAC	Capacitance Value (μ F)	Size Code (New/Legacy)	B (mm)	H (mm)	L (mm)	Chip Size	dV/dt (V/ μ s)	New KEMET Part Number	Legacy Part Number

(1) K = \pm 10%, M = \pm 20%, other tolerances on request.

(2) Insert ordering code for lead type and packaging. See Ordering Options Table for available options.

Table 1 – Ratings & Part Number Reference cont'd

VDC	VAC	Cap Value (µF)	Size Code (New/Legacy)	Dimensions in mm			Chip Size	dV/dt (V/µs)	New KEMET Part Number	Legacy Part Number
				B	H	L				
400	200	0.010	WP/A31	9.1	5.5	10.2	4036	1300	F117WP103(1)400(2)	GPC10.2103(1)400A31(2)
400	200	0.015	WP/A31	9.1	5.5	10.2	4036	1300	F117WP153(1)400(2)	GPC10.2153(1)400A31(2)
400	200	0.022	WP/A31	9.1	5.5	10.2	4036	1300	F117WP223(1)400(2)	GPC10.2223(1)400A31(2)
400	200	0.027	WP/A31	9.1	5.5	10.2	4036	1300	F117WP273(1)400(2)	GPC10.2273(1)400A31(2)
400	200	0.033	YR/B31	11.5	6.5	12.7	5045	900	F117YR333(1)400(2)	GPC12.7333(1)400B31(2)
400	200	0.047	YR/B31	11.5	6.5	12.7	5045	900	F117YR473(1)400(2)	GPC12.7473(1)400B31(2)
400	200	0.068	YR/B31	11.5	6.5	12.7	5045	900	F117YR683(1)400(2)	GPC12.7683(1)400B31(2)
400	200	0.10	ZS/C31	15.0	7.0	16.5	6560	450	F117ZS104(1)400(2)	GPC16.5104(1)400C31(2)
400	200	0.15	ZS/C31	15.0	7.0	16.5	6560	450	F117ZS154(1)400(2)	GPC16.5154(1)400C31(2)
400	200	0.22	ZS/C31	15.0	7.0	16.5	6560	450	F117ZS224(1)400(2)	GPC16.5224(1)400C31(2)
630	300	0.00047	SL/K33	6.0	3.0	7.3	2824	2000	F117SL471(1)630(2)	GPC7.3471(1)630K33(2)
630	300	0.00068	SL/K33	6.0	3.0	7.3	2824	2000	F117SL681(1)630(2)	GPC7.3681(1)630K33(2)
630	300	0.0010	SL/K33	6.0	3.0	7.3	2824	2000	F117SL102(1)630(2)	GPC7.3102(1)630K33(2)
630	300	0.0015	SL/K33	6.0	3.0	7.3	2824	2000	F117SL152(1)630(2)	GPC7.3152(1)630K33(2)
630	300	0.0022	SL/K33	6.0	3.0	7.3	2824	2000	F117SL222(1)630(2)	GPC7.3222(1)630K33(2)
630	300	0.0033	SL/K33	6.0	3.0	7.3	2824	2000	F117SL332(1)630(2)	GPC7.3332(1)630K33(2)
630	300	0.0047	SP/K35	6.0	3.5	7.3	2824	2000	F117SP472(1)630(2)	GPC7.3472(1)630K35(2)
630	300	0.0068	ST/K37	6.0	4.5	7.3	2824	2000	F117ST682(1)630(2)	GPC7.3682(1)630K37(2)
630	300	0.0068	WP/A31	9.1	5.5	10.2	4036	1600	F117WP682(1)630(2)	GPC10.2682(1)630A31(2)
630	300	0.010	WP/A31	9.1	5.5	10.2	4036	1600	F117WP103(1)630(2)	GPC10.2103(1)630A31(2)
630	300	0.015	WP/A31	9.1	5.5	10.2	4036	1600	F117WP153(1)630(2)	GPC10.2153(1)630A31(2)
630	300	0.022	WP/A31	9.1	5.5	10.2	4036	1600	F117WP223(1)630(2)	GPC10.2223(1)630A31(2)
630	300	0.033	YR/B31	11.5	6.5	12.7	5045	1100	F117YR333(1)630(2)	GPC12.7333(1)630B31(2)
630	300	0.047	YR/B31	11.5	6.5	12.7	5045	1100	F117YR473(1)630(2)	GPC12.7473(1)630B31(2)
630	300	0.068	ZS/C31	15.0	7.0	16.5	6560	550	F117ZS683(1)630(2)	GPC16.5683(1)630C31(2)
630	300	0.10	ZS/C31	15.0	7.0	16.5	6560	550	F117ZS104(1)630(2)	GPC16.5104(1)630C31(2)
1000	350	0.00047	SL/K33	6.0	3.0	7.3	2824	2200	F117SL471(1)1K0(2)	GPC7.3471(1)1000K33(2)
1000	350	0.00068	SL/K33	6.0	3.0	7.3	2824	2200	F117SL681(1)1K0(2)	GPC7.3681(1)1000K33(2)
1000	350	0.0010	SL/K33	6.0	3.0	7.3	2824	2200	F117SL102(1)1K0(2)	GPC7.3102(1)1000K33(2)
1000	350	0.0015	SL/K33	6.0	3.0	7.3	2824	2200	F117SL152(1)1K0(2)	GPC7.3152(1)1000K33(2)
1000	350	0.0022	SL/K33	6.0	3.0	7.3	2824	2200	F117SL222(1)1K0(2)	GPC7.3222(1)1000K33(2)
1000	350	0.0033	SP/K35	6.0	3.5	7.3	2824	2200	F117SP332(1)1K0(2)	GPC7.3332(1)1000K35(2)
1000	350	0.0047	ST/K37	6.0	4.5	7.3	2824	2200	F117ST472(1)1K0(2)	GPC7.3472(1)1000K37(2)
1000	350	0.0068	WP/A31	9.1	5.5	10.2	4036	1700	F117WP682(1)1K0(2)	GPC10.2682(1)1000A31(2)
1000	350	0.010	WP/A31	9.1	5.5	10.2	4036	1700	F117WP103(1)1K0(2)	GPC10.2103(1)1000A31(2)
1000	350	0.015	WP/A31	9.1	5.5	10.2	4036	1700	F117WP153(1)1K0(2)	GPC10.2153(1)1000A31(2)
1000	350	0.022	YR/B31	11.5	6.5	12.7	5045	1200	F117YR223(1)1K0(2)	GPC12.7223(1)1000B31(2)
1000	350	0.033	YR/B31	11.5	6.5	12.7	5045	1200	F117YR333(1)1K0(2)	GPC12.7333(1)1000B31(2)
1000	350	0.047	ZS/C31	15.0	7.0	16.5	6560	600	F117ZS473(1)1K0(2)	GPC16.5473(1)1000C31(2)
1000	350	0.068	ZS/C31	15.0	7.0	16.5	6560	600	F117ZS683(1)1K0(2)	GPC16.5683(1)1000C31(2)
VDC	VAC	Capacitance Value (µF)	Size Code (New/Legacy)	B (mm)	H (mm)	L (mm)	Chip Size	dV/dt (V/µs)	New KEMET Part Number	Legacy Part Number

(1) K = ±10%, M = ±20%, other tolerances on request.

(2) Insert ordering code for lead type and packaging. See Ordering Options Table for available options.

Soldering Process

Reflow soldering temperature is measured on the top surface of the component. Preheating temperature should be less than 170°C. The time above 217°C should be less than 50 seconds. The peak temperature must not exceed 250°C.

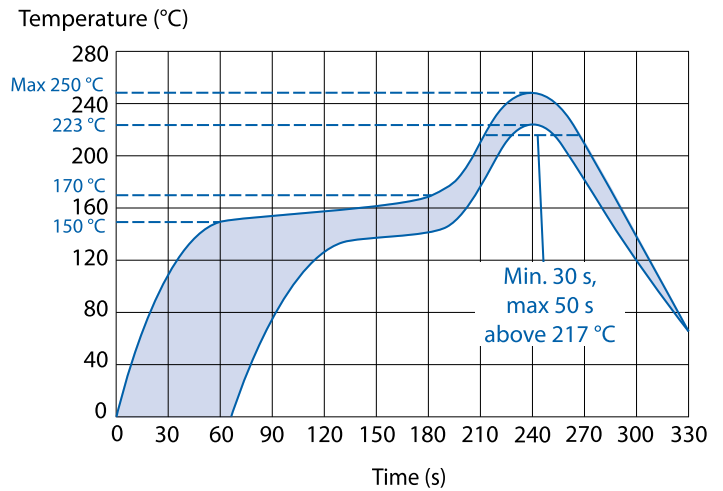

Marking

- Capacitance
- Capacitance tolerance code
- Rated voltage code
- Capacitor type P for GPC
- Manufacturing date code

Rated Voltage	Code
63 VDC	C
100 VDC	D
160 VDC	F
250 VDC	H
400 VDC	K
630 VDC	M
1,000 VDC	P

Manufacturing Date Code (IEC 60062)			
Y = Year, Z = Month			
Year	Code	Month	Code
2000	M	January	1
2001	N	February	2
2002	P	March	3
2003	R	April	4
2004	S	May	5
2005	T	June	6
2006	U	July	7
2007	V	August	8
2008	W	September	9
2009	X	October	0
2010	A	November	N
2011	B	December	D
2012	C		
2013	D		
2014	E		
2015	F		
2016	H		
2017	J		
2018	K		
2019	L		
2020	M		

Flux & Cleaning

KEMET recommends to use a no-clean flux with a halogen content lower than 0.1%.

To clean the PCB assembly KEMET recommends to use a suitable solvent like Isopropyl alcohol, deionized water or neutral pH detergents. Aggressive solvents shall not be used. For any different cleaning solvent used please contact KEMET Technical Services to analyze the potential impact on KEMET products.

Storage and Moisture Recommendations

KEMET SMD Film Capacitors are supplied in a MBB (Moisture Barrier Bag) Class 1. We can guarantee a 24 months shelf life (temperature $\leq 40^{\circ}\text{C}$ /relative humidity $\leq 90\%$). After the MBB has been opened, components may stay in areas with controlled temperature and humidity (temperature $\leq 30^{\circ}\text{C}$ /relative humidity $\leq 60\%$) for 168 hours [MSL 3]. For longer periods of time and/or higher temperature and/or higher relative humidity values, it is absolutely necessary to protect the components against humidity. If the reel inside the MBB is partially used, KEMET recommends to re-use the same MBB or to avoid areas without controlled temperature and humidity (see above). If the above conditions are not respected, components require a baking (minimum time: 48 hours at $55 \pm 5^{\circ}\text{C}$) before the reflow.

Packaging Quantities

Chip Size (EIA)	Base (mm)	Height (mm)	Length (mm)	Bulk	Reel Horizontal Orientation	Reel Vertical Orientation
2824	6	3	7.3	2000	2500	
2824	6	3.5	7.3	2000	2300	
2824	6	4.5	7.3	1000	1700	
4036	9.1	5.5	10.2	1000	800	500
5045	11.5	6.5	12.7	1000	600	400
6560	15	7	16.5	800	500	200

Landing

Mounting	Chip Size	Dimensions in mm		
		A	B	X
Horizontal	2220	5.1	1.5	3.0
	2824	6.1	1.5	3.8
	4036	9.1	2.0	5.5
	5045	11.6	2.5	7.0
	6560	15.0	3.0	9.0
Vertical	4022	5.6	2.0	5.5
	5026	6.6	2.5	7.0
	6528	7.1	3.0	9.0

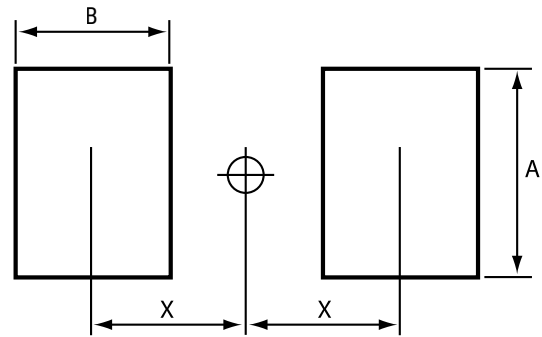

Carrier Taping & Packaging (IEC 60286-2)

Horizontal Taping Orientation

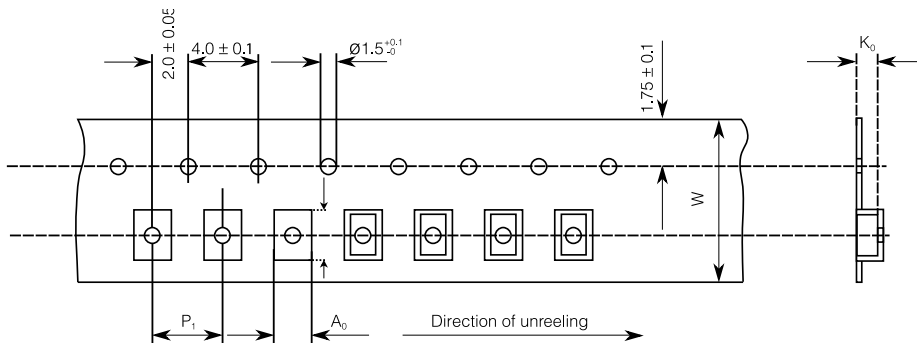

Chip Size (EIA) Horizontal Mounting	Dimensions in mm				Taping Specification						
	B	H	L	W	P ₁	A ₀	B ₀	K ₀	D	W ₁	W ₂
	Nominal	Nominal	Nominal	-0/+0.3	+/-0.1	Nominal	Nominal	Nominal	-/+2.0	-0/+2	Maximum
2220	5.0	3.0	5.7	12.0	8.0	5.5	6.0	3.3	330	12.4	22.0
2220	5.0	4.0	5.7	12.0	8.0	5.5	6.0	4.3	330	12.4	22.0
2824	6.0	3.0	7.3	12.0	8.0	6.5	7.5	3.3	330	12.4	22.0
2824	6.0	3.5	7.3	12.0	8.0	6.5	7.5	3.8	330	12.4	22.0
2824	6.0	4.5	7.3	16.0	8.0	6.6	7.9	5.5	330	16.0	20.0
4036	9.1	5.5	10.2	16.0	16.0	9.5	10.5	5.8	330	16.4	22.0
5045	11.5	6.5	12.7	24.0	16.0	11.9	13.1	6.8	330	24.4	30.0
6560	15.0	7.0	16.5	24.0	20.0	15.4	16.8	7.3	330	24.4	30.0

Carrier Taping & Packaging (IEC 60286-2) cont'd

Vertical Taping Orientation

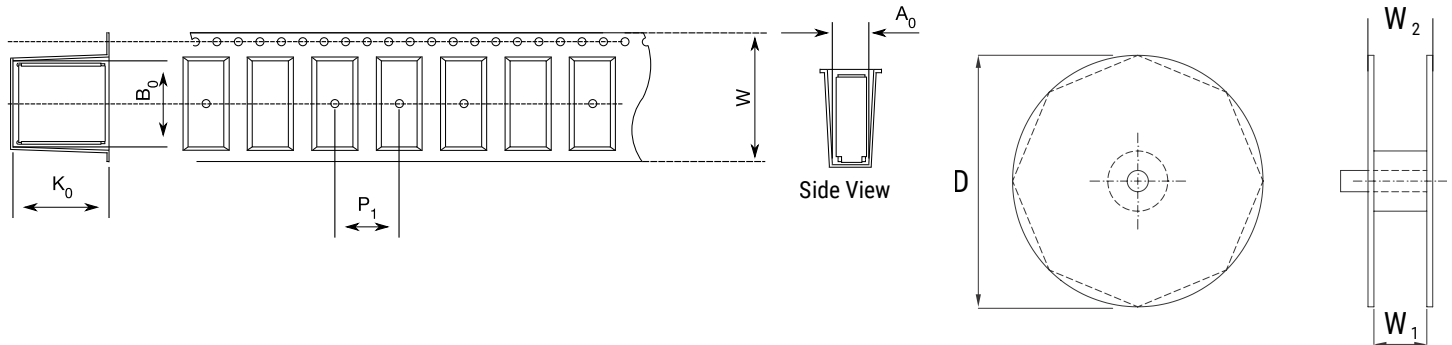

Size Code Vertical Mounting	Dimensions in mm			Taping Specification							
	B	H	L	W	P ₁	A ₀	B ₀	K ₀	D	W ₁	W ₂
	Nominal	Nominal	Nominal	-0/+0.3	+/-0.1	Nominal	Nominal	Nominal	-/+2.0	-0/+2	Maximum
4022	5.5	9.1	10.2	24.0	16.0	6.0	10.5	9.3	330	24.4	30.0
5026	6.5	11.5	12.7	24.0	16.0	6.9	13.1	11.8	330	24.4	30.0
6528	7.0	15.0	16.5	44.0	20.0	7.5	17.0	15.3	330	44.5	49.5

Note: Chip dimensions B and H correspond to dimensions H and B in the horizontal mounting table.

KEMET Electronic Corporation Sales Offices

For a complete list of our global sales offices, please visit www.kemet.com/sales.

Disclaimer

All product specifications, statements, information and data (collectively, the "Information") in this datasheet are subject to change. The customer is responsible for checking and verifying the extent to which the Information contained in this publication is applicable to an order at the time the order is placed.

All Information given herein is believed to be accurate and reliable, but it is presented without guarantee, warranty, or responsibility of any kind, expressed or implied.

Statements of suitability for certain applications are based on KEMET Electronics Corporation's ("KEMET") knowledge of typical operating conditions for such applications, but are not intended to constitute – and KEMET specifically disclaims – any warranty concerning suitability for a specific customer application or use. The Information is intended for use only by customers who have the requisite experience and capability to determine the correct products for their application. Any technical advice inferred from this Information or otherwise provided by KEMET with reference to the use of KEMET's products is given gratis, and KEMET assumes no obligation or liability for the advice given or results obtained.

Although KEMET designs and manufactures its products to the most stringent quality and safety standards, given the current state of the art, isolated component failures may still occur. Accordingly, customer applications which require a high degree of reliability or safety should employ suitable designs or other safeguards (such as installation of protective circuitry or redundancies) in order to ensure that the failure of an electrical component does not result in a risk of personal injury or property damage.

Although all product-related warnings, cautions and notes must be observed, the customer should not assume that all safety measures are indicated or that other measures may not be required.

KEMET is a registered trademark of KEMET Electronics Corporation.

单击下面可查看定价，库存，交付和生命周期等信息

[>>KEMET Electronics\(基美\)](#)