

CVM Studio COB Arrays

LED Entertainment Lighting

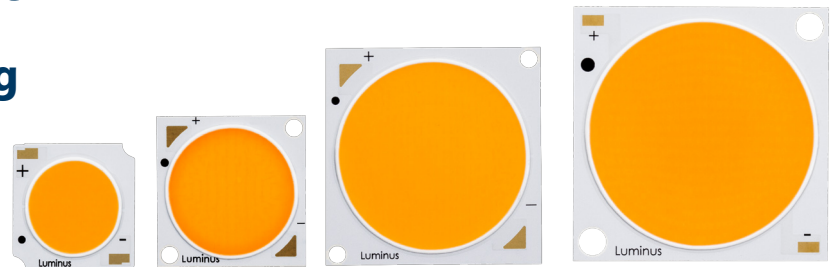

Table of Contents

Technology Overview2

Test Specifications2

Chromaticity Bins3

Product Ordering & Shipping Part Numbers4

Product Typical Flux Range 5

Operating Characteristics ..5

Optical and Electrical Characteristics.....7

Spectra 11

Mechanical Dimensions .. 12

Packaging Information ... 12

Handling Notes 17

Features:

- High lumen output
 - Over 25,000 lm @ 3150K, 25°C
 - Over 27,000 lm @ 5600K, 25°C
- 3150K and 5600K CCT
- 95 CRI minimum
- 90 TLCI minimum
- 2 SDCM color binning accuracy
- Excellent optical emission uniformity and color over angle consistency
- Exceptional long term color stability
- Superior thermal conductivity for uniform heat spreading
- Environmentally friendly: RoHS and REACH compliant
- UL certified, file # E465703
- 

Applications

- TV Studio
- Film Production
- Still Photography
- Stage/Set Lights
- Architectural/Hospitality

Technology Overview

Luminus Chip-on-Board (COB) LED series offers a complete lighting class solution designed for high performance illumination applications. The selection covers a wide lumen range from less than 400lm to over 10,000lm, all major color temperatures and can deliver color rendering greater than 97 at 2700K and 3000K and R9 equal to 95. These breakthroughs allow illumination engineers and designers to develop lighting solutions with maximum efficacy, brightness and overall quality.

Reliability

Designed from the ground up, the Luminus COB LED is one of the most reliable light sources in the world today. Having passed a rigorous suite of environmental and mechanical stress tests, including mechanical shock, vibration, temperature cycling and humidity. Only then are the devices qualified for use in a wide range of lighting application including some of the most demanding commercial applications.

UL Recognized Compliance

Luminus COB arrays are tested in accordance with ANSI/UL 8750 to ensure safe operation for their intended applications.

REACH & RoHS Compliance

All LED products manufactured by Luminus are REACH and RoHS compliant and free of hazardous materials, including lead and mercury.

Understanding Luminus COB LED Test Specifications

Every Luminus LED is fully tested to ensure it meets the high quality standards customers have come to expect from Luminus' products.

Traceability

Each Luminus COB LED is marked with a 2D bar code that contains a unique serial number. With this serial number, Luminus has the ability to provide customers with actual test data measurements for a specific LED. In addition, the 2D bar code is linked to manufacturing date codes that enables traceability of production processes and materials.

Chromaticity Bin Range

Chromaticity binning delivers color consistency for every order. Studio products are delivered with a 2-step MacAdam ellipse. This ensures color performance matching in the application. These tightly controlled, small distribution bins provide customers predictable, repeatable colors.

Testing Temperature

Luminus Studio products are measured at temperatures typical for the LED operating in the fixture. Each device is tested at 85°C junction temperature eliminating the need to scale datasheet specifications to real world situations.

Chromaticity Bin Structure

Chromaticity Bins: 1931 CIE Curve

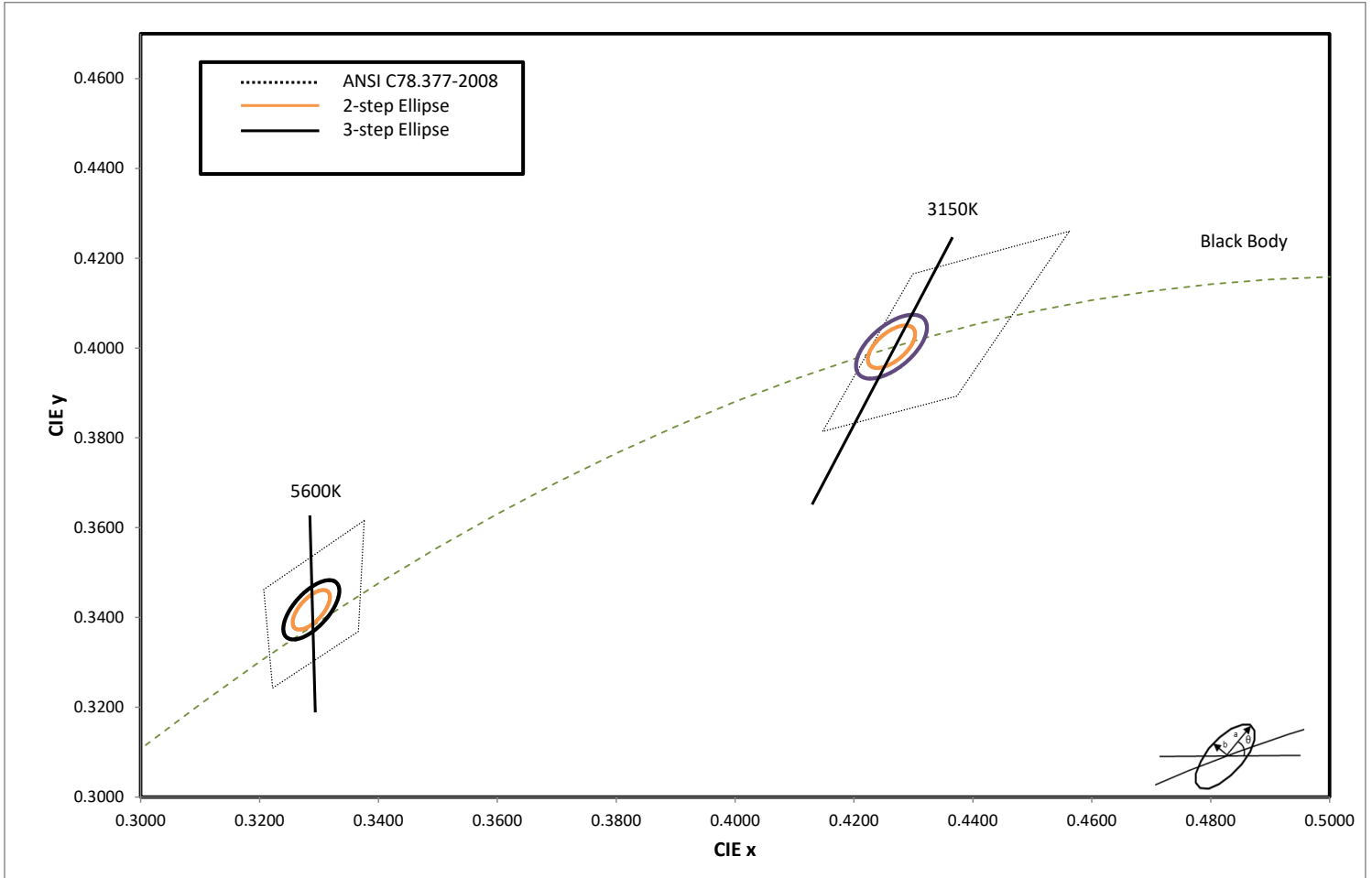

CVM White Chromaticity Bins

The following tables describe the ANSI bin center points, the orientation angle for the MacAdam ellipse (θ°), and the maximum radii for the ellipses. The ANSI Bin is provided for reference.

CCT	Center Point		Angle θ°	2-step Bin		3-step Bin	
	CIE _x	CIE _y		a	b	a	b
3150K	0.4263	0.4003	53.2	0.00556	0.00272	0.00834	0.00408
5600K	0.3287	0.3417	59.1	0.00497	0.00213	0.00746	0.0032

*Note: Luminus maintains a +/- 0.005 tolerance on chromaticity (CIE_x and CIE_y) measurements.

Product Ordering and Shipping Part Number Nomenclature

All CVM products are packaged and labeled with part numbers as outlined in the table on page 5. When shipped, each package will contain only a single flux and chromaticity bin. The part number designation is as follows:

CVM — XX — NN — 95 — VV — QQPP — FG — W

Product Family	Light Emitting Surface Diameter	Color Temperature	Color Rendering Index (CRI)	Voltage (typical)	Package Configurator	Flux Bin	Chromaticity Bin
CVM: Chip on Board, Studio	Approx. LES Diameter (mm)	Color See Note 1 below	CRI See Note 2 below	Volts	See Note 3 below	Lumens	See page 3 for bins

Note 1: NN nomenclature corresponds to the following:

- 31 = 3150K
- 56 = 5600K

Note 2: XX CRI is specified as minimum value

95 CRI is 95 minimum

Note 3: AA00 - Standard Package Configurator

AC00 / AB00 - Alternative Package Configurator

Example 1:

The ordered part number CVM-27-56-95-36-AA00-F2-2 which refers to a 26.5 millimeter diameter emitter, at color temperature 5600K, a minimum CRI of 95, a typical voltage of 36V, a standard package, a typical flux of 10,500 lumens and a 2-step MacAdam ellipse chromaticity range.

Note: Luminus part numbers may be accompanied by prefixes or suffixes. The most common is the "Rev01" suffix indicating a part is fully released and carries a full warranty. These additional characters may appear on shipping labels, packing slips and invoices. In all cases the basic part number described above will always be included.

CVM Part Numbers

The following tables describe products with typical flux and minimum flux measured at the maximum rated current and specified at junction temperature, $T_j = 85^\circ\text{C}$. The values at 25°C are calculated and shown for reference only.

CCT	LES (mm)	Test Current (A)	Output Flux (lm)		Reference	2-step MacAdam Ellipse	3-step MacAdam Ellipse
			Typ. (85°C)	Min. (85°C)	Typ. (calculated) (25°C)		
3150K	13.5	1.0	2,575	2,395	3,085	CVM-14-31-95-36-AC00-F2-2	CVM-14-31-95-36-AC00-F2-3
	17.5	1.8	5,140	4,880	5,655	CVM-18-31-95-36-AA00-F2-2	CVM-18-31-95-36-AA00-F2-3
	26.5	4.2	11,500	10,750	13,800	CVM-27-31-95-36-AA00-F2-2	CVM-27-31-95-36-AA00-F2-3
	26.5	4.2	11,500	10,750	13,800	CVM-27-31-95-36-AB00-F2-2	CVM-27-31-95-36-AB00-F2-3
	32	5.0	22,800	21,250	25,150	CVM-32-31-95-54-AC00-F2-2	CVM-32-31-95-54-AC00-F2-3
5600K	13.5	1.0	2,800	2,600	3,350	CVM-14-56-95-36-AC00-F2-2	CVM-14-56-95-36-AC00-F2-3
	17.5	1.8	5,625	5,345	6,190	CVM-18-56-95-36-AA00-F2-2	CVM-18-56-95-36-AA00-F2-3
	26.5	4.2	12,500	11,500	15,000	CVM-27-56-95-36-AA00-F2-2	CVM-27-56-95-36-AA00-F2-3
	26.5	4.2	12,500	11,500	15,000	CVM-27-56-95-36-AB00-F2-2	CVM-27-56-95-36-AB00-F2-3
	32	5.0	24,800	23,110	27,350	CVM-32-56-95-54-AC00-F2-2	CVM-32-56-95-54-AC00-F2-3

CVM Operating Characteristics¹
CVM-14

Parameter	Symbol	Typical	Maximum	Unit
Forward Current ²	I_f	1	1	A
Forward Voltage	V_f	36	40	V
Power		36	40	W
Operating Case Temperature ³	T_c		100	$^\circ\text{C}$
Light Emitting Surface Diameter	LES	13.5		mm
Thermal Resistance (junction-to-case)	Θ_{jc}	0.46		$^\circ\text{C}/\text{W}$
Viewing Angle		120		Degree

*Note: Luminus maintains a +/- 6% tolerance on flux measurements.

Luminus maintains a +/- 2% tolerance on CRI measurements.

CVM Operating Characteristics
CVM-18

Parameter	Symbol	Typical	Maximum	Unit
Forward Current ²	I_f	1.8	1.8	A
Forward Voltage	V_f	36	40	V
Power		65	72	W
Operating Case Temperature ³	T_c		100	°C
Light Emitting Surface Diameter	LES	17.5		mm
Thermal Resisitance (junction-to-case)	Θ_{jc}	0.30		°C/W
Viewing Angle		120		Degree

CVM-27

Parameter	Symbol	Typical	Maximum	Unit
Forward Current ²	I_f	4.2	4.2	A
Forward Voltage	V_f	36	40	V
Power		150	168	W
Operating Case Temperature ³	T_c		100	°C
Light Emitting Surface Diameter	LES	26.5		mm
Thermal Resisitance (junction-to-case)	Θ_{jc}	0.16		°C/W
Viewing Angle		120		Degree

CVM-32

Parameter	Symbol	Typical	Maximum	Unit
Forward Current ²	I_f	5.0	5.0	A
Forward Voltage ³	V_f	54.5	58	V
Power		272.5	290	W
Operating Case Temperature ⁴	T_c		100	°C
Light Emitting Surface Diameter	LES	32		mm
Thermal Resisitance (junction-to-case)	Θ_{jc}	0.10 (est.)		°C/W
Viewing Angle		120		Degree

Note 1: Ratings are based on operation at a constant junction temperature of $T_j = 85^\circ\text{C}$.

Note 2: Although products are specified at Maximum Current, they are all capable to be driven down to currents as low as 20% of the typical value. Operation below these current levels may result in uneven light distribution across the LES surface.

Note 3: Voltage is rated at typical forward current. For voltage at lower drive current, refer to performance graphs

Note 3: Maximum operating case temperature combined with maximum drive current defines the total maximum operating condition for the device. To prevent damage, please follow derating curves for all operating conditions.

Note 4: All product specifications are subject to change without prior notice.

Note 5: Caution must be taken not to stare at the light emitted from these LEDs. Under special circumstances, the high intensity could damage the eye.

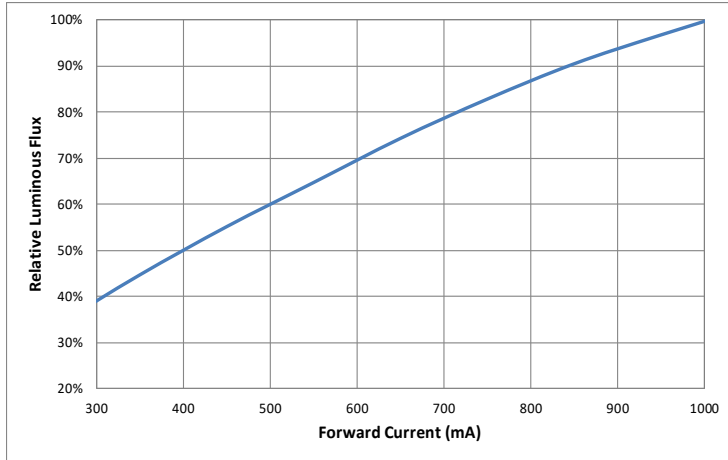
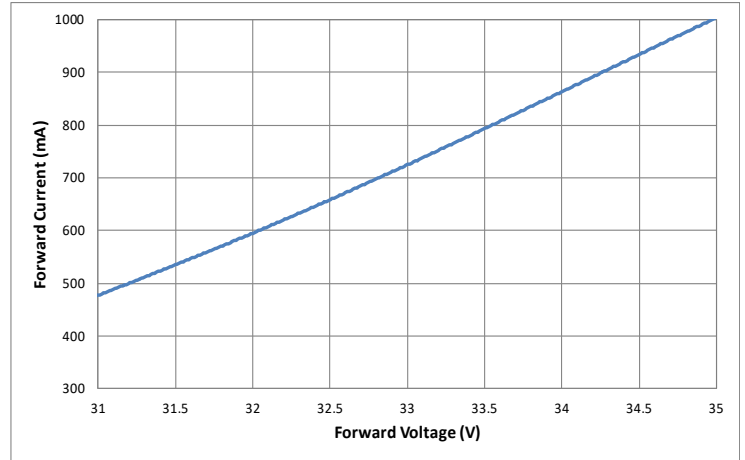
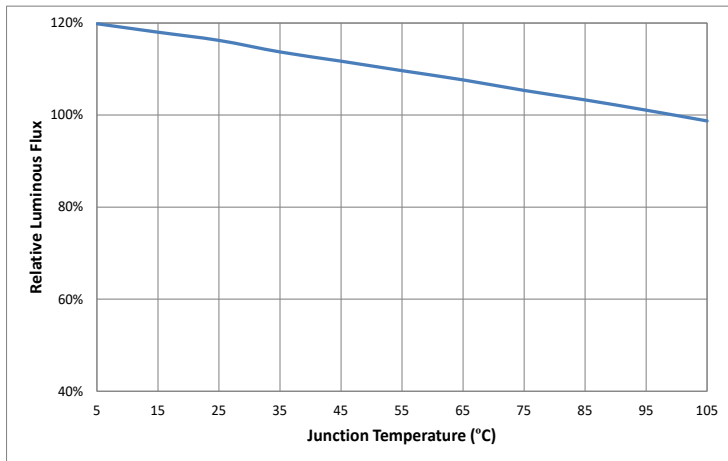
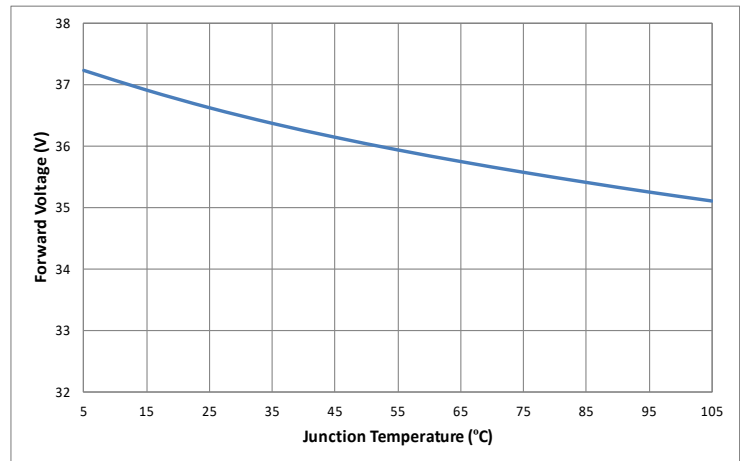
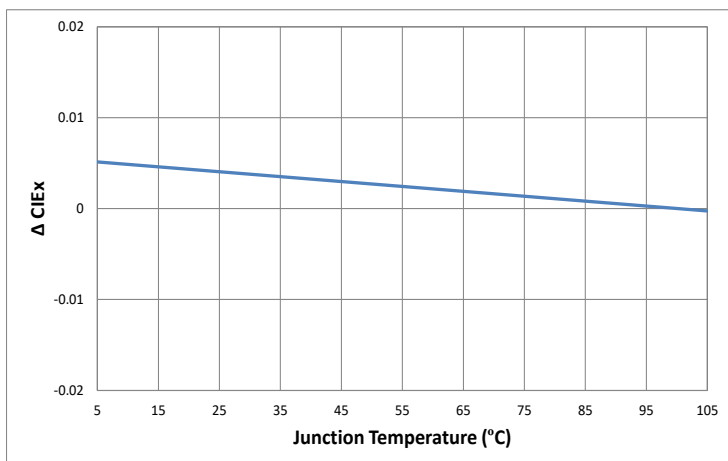
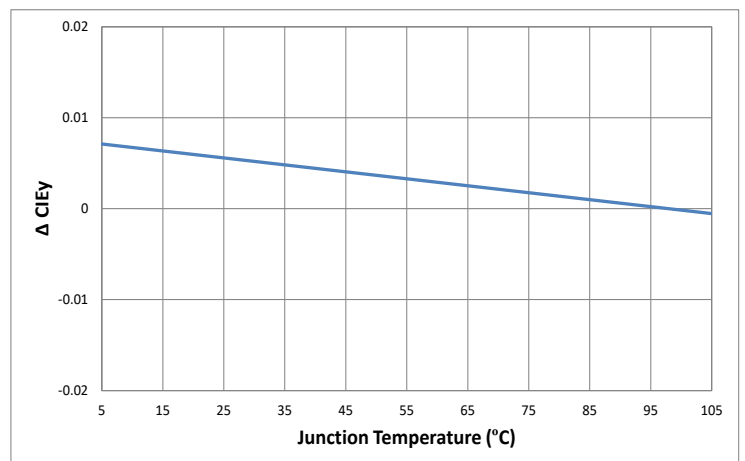
CVM-14 Optical & Electrical Characteristics
Relative Output Flux vs. Forward Current @ 85°C

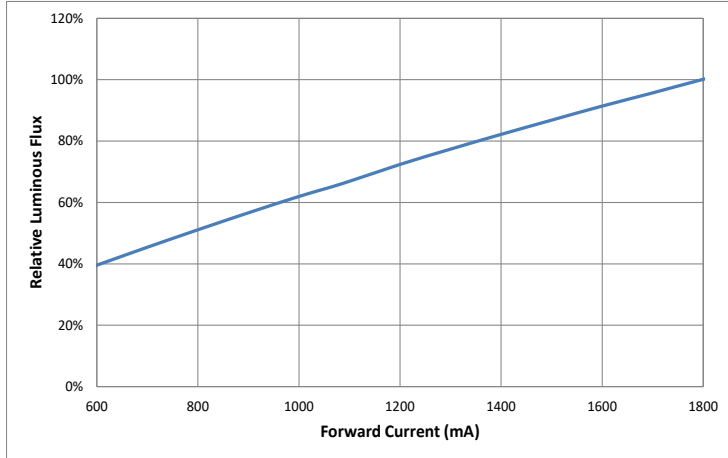
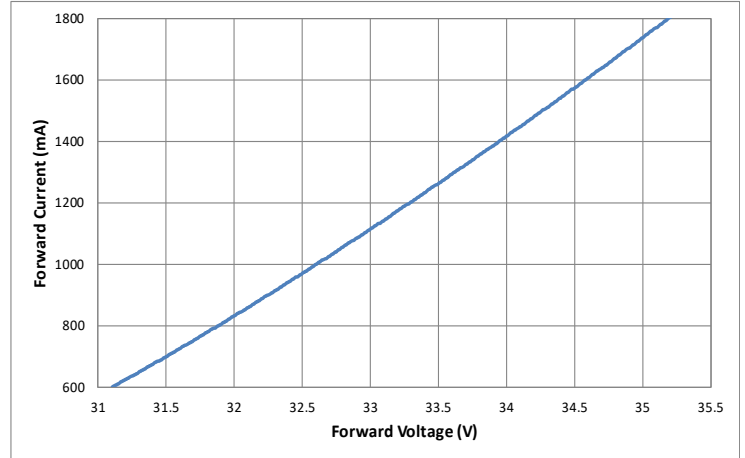
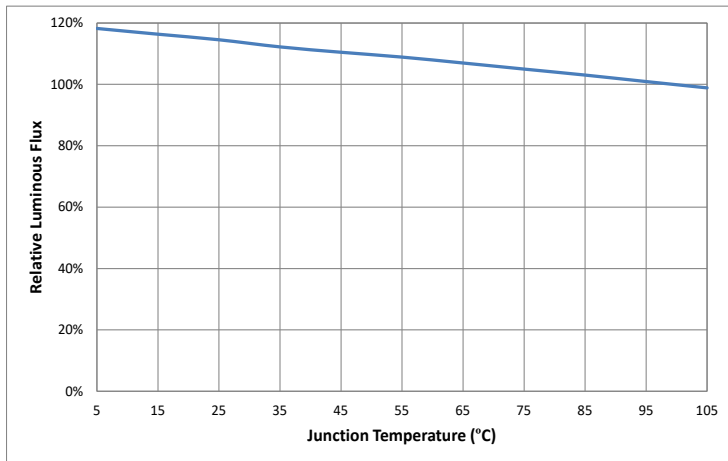
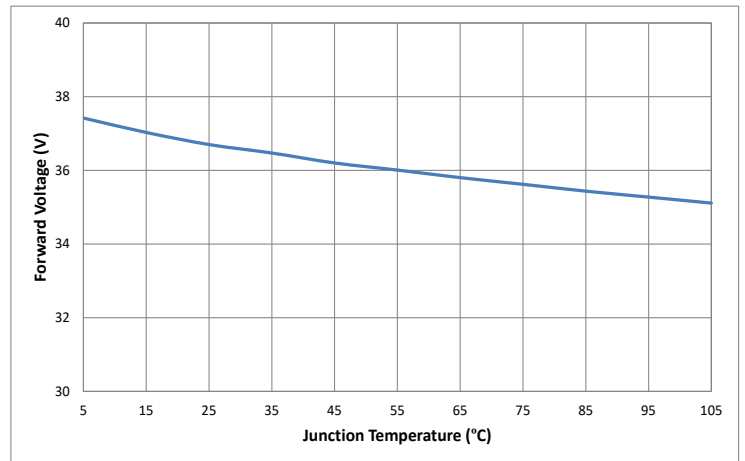
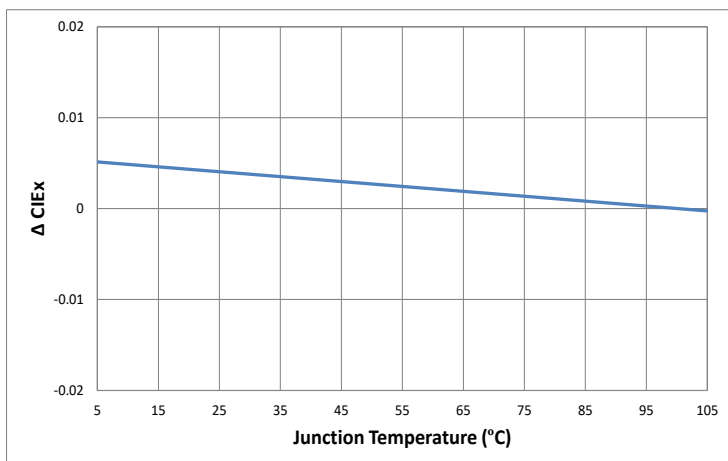
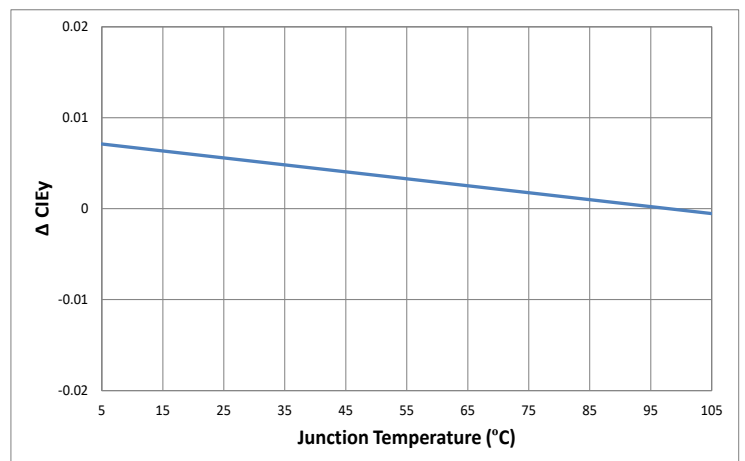
Forward Current vs. Forward Voltage @ 85°C

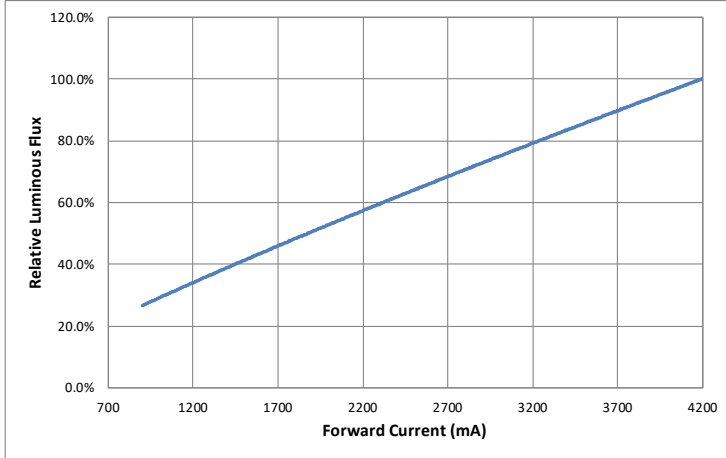
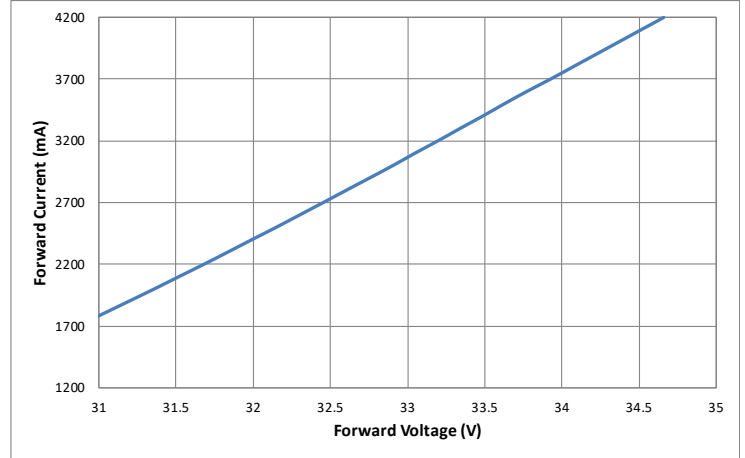
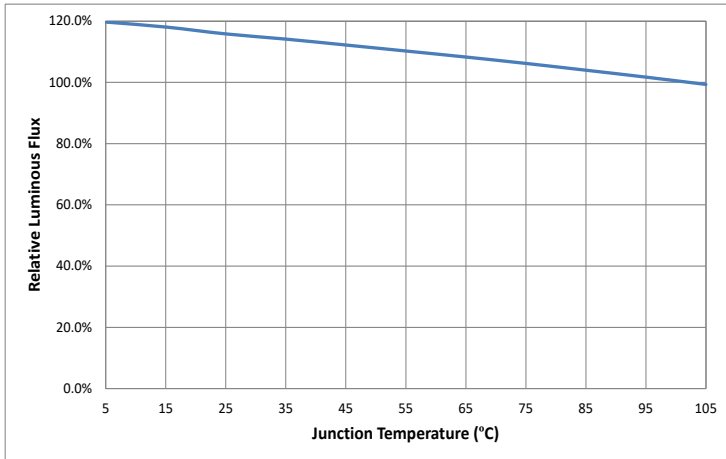
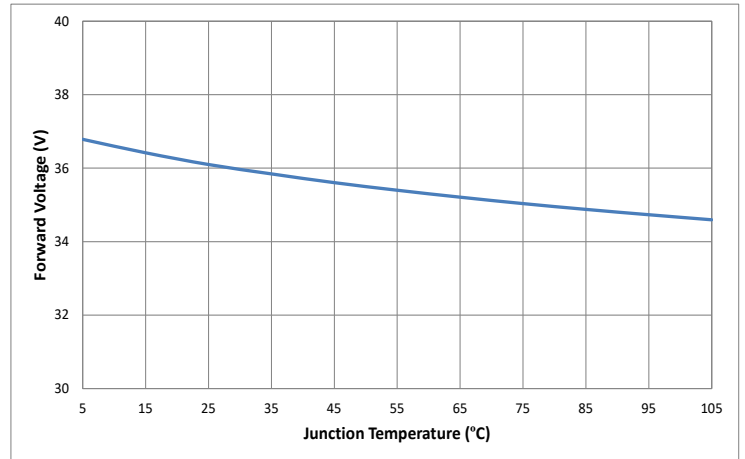
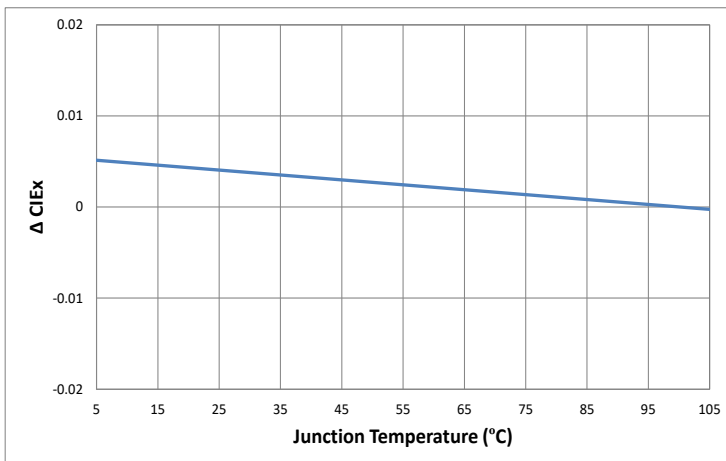
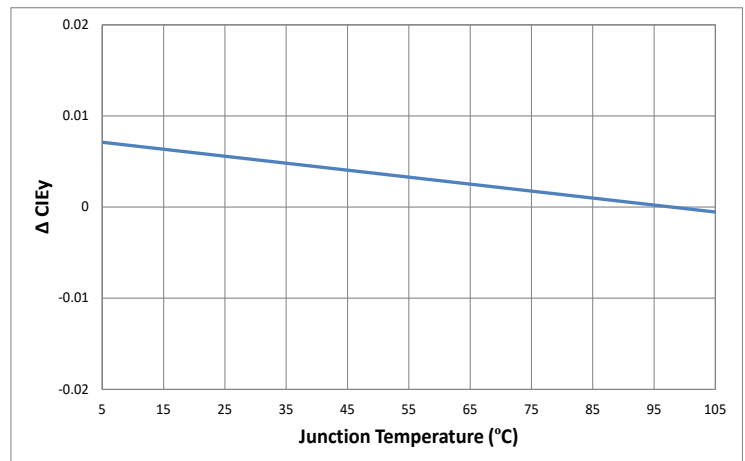
Relative Output Flux vs. Junction Temperature

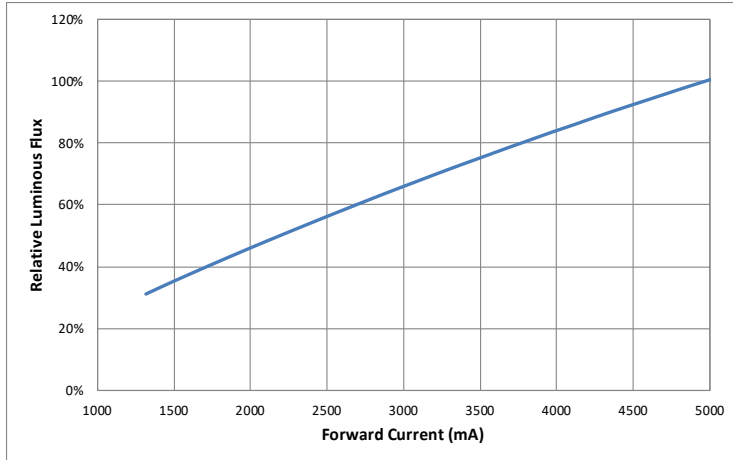
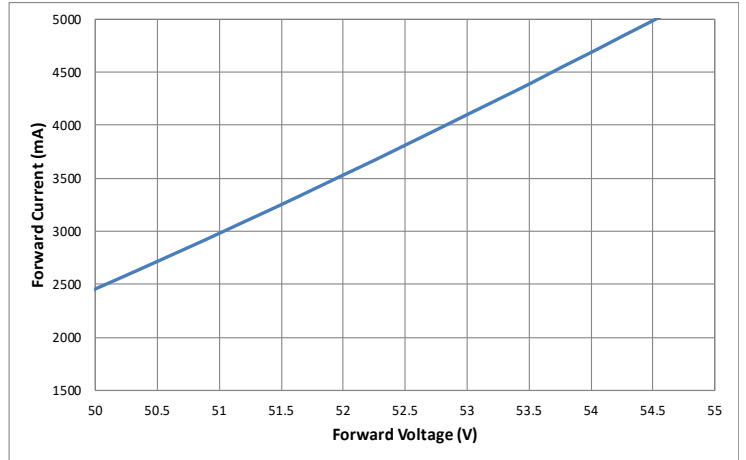
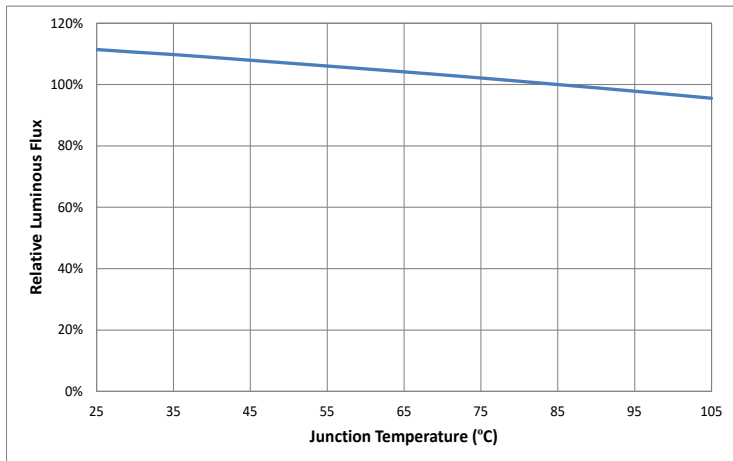
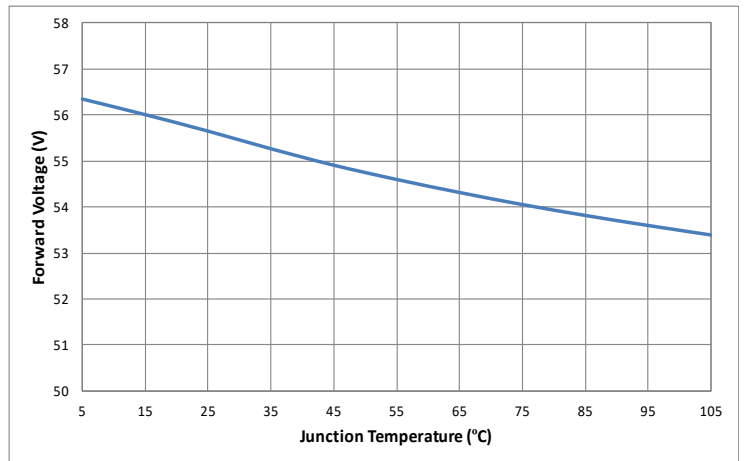
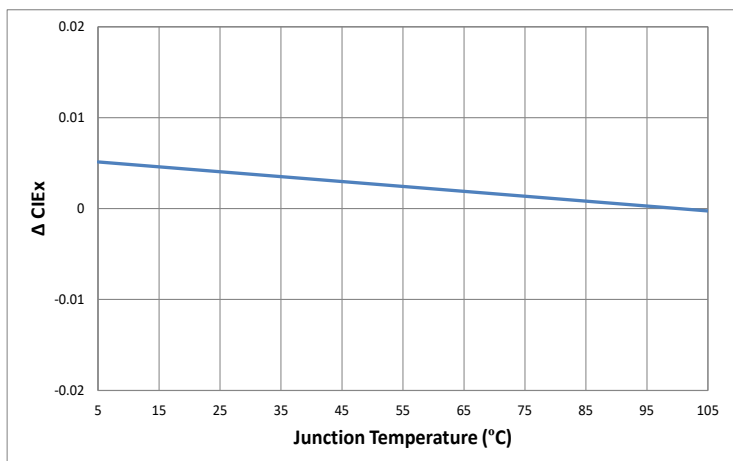
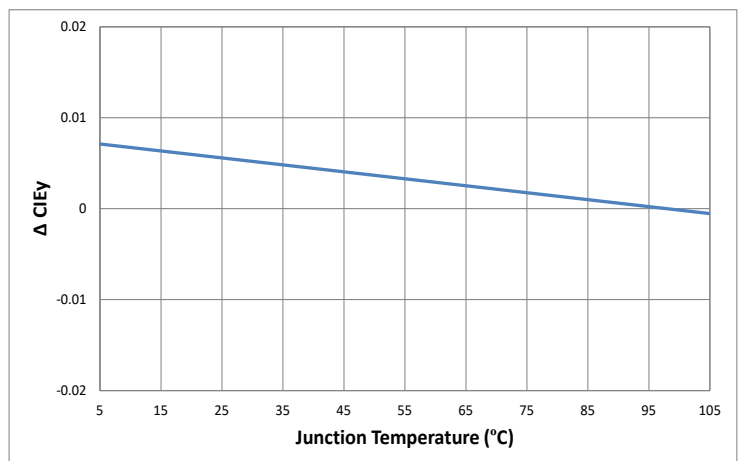
Change in Voltage vs. Junction Temperature

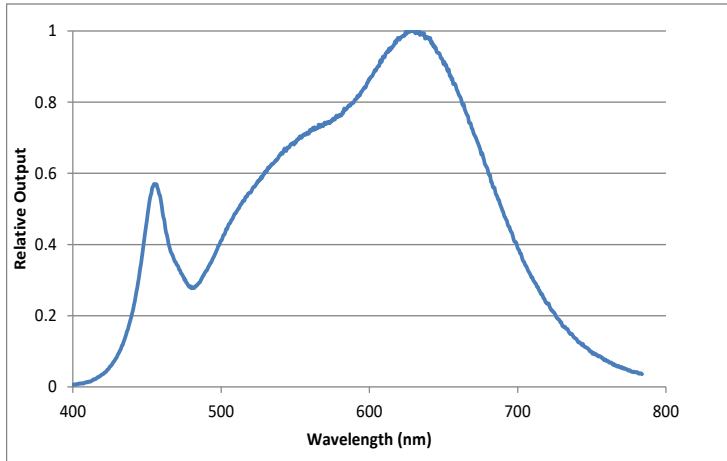
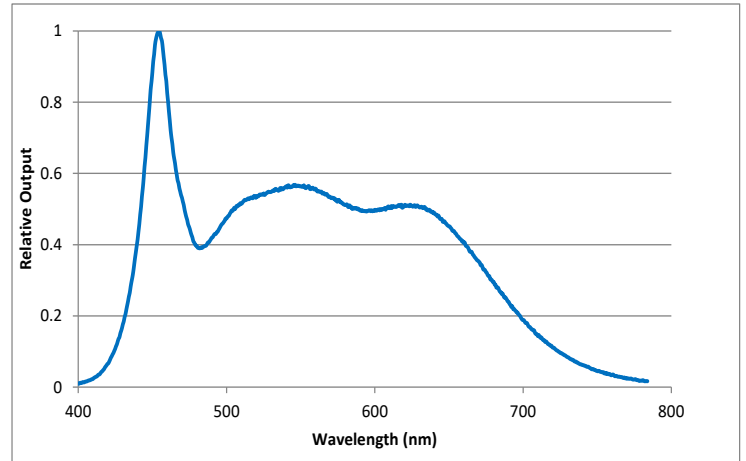
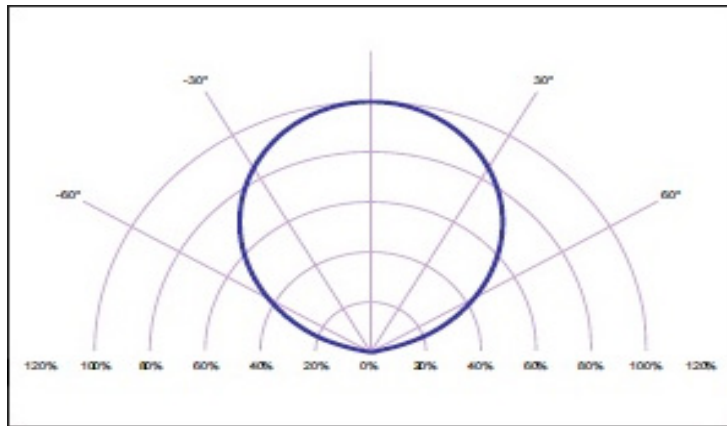
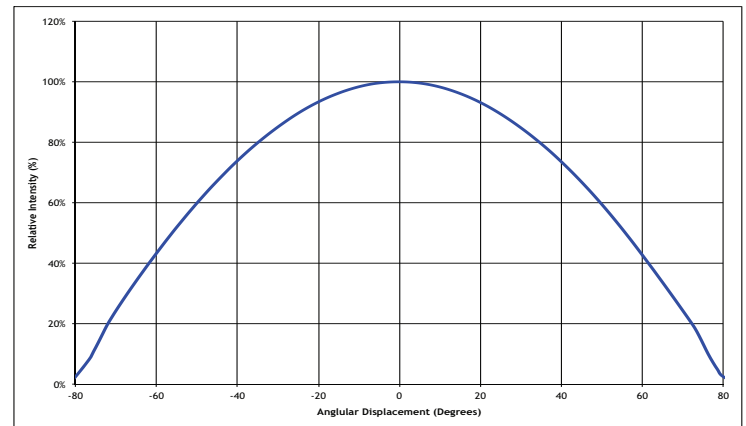
Change in CIE_x vs. Junction Temperature (3100K)

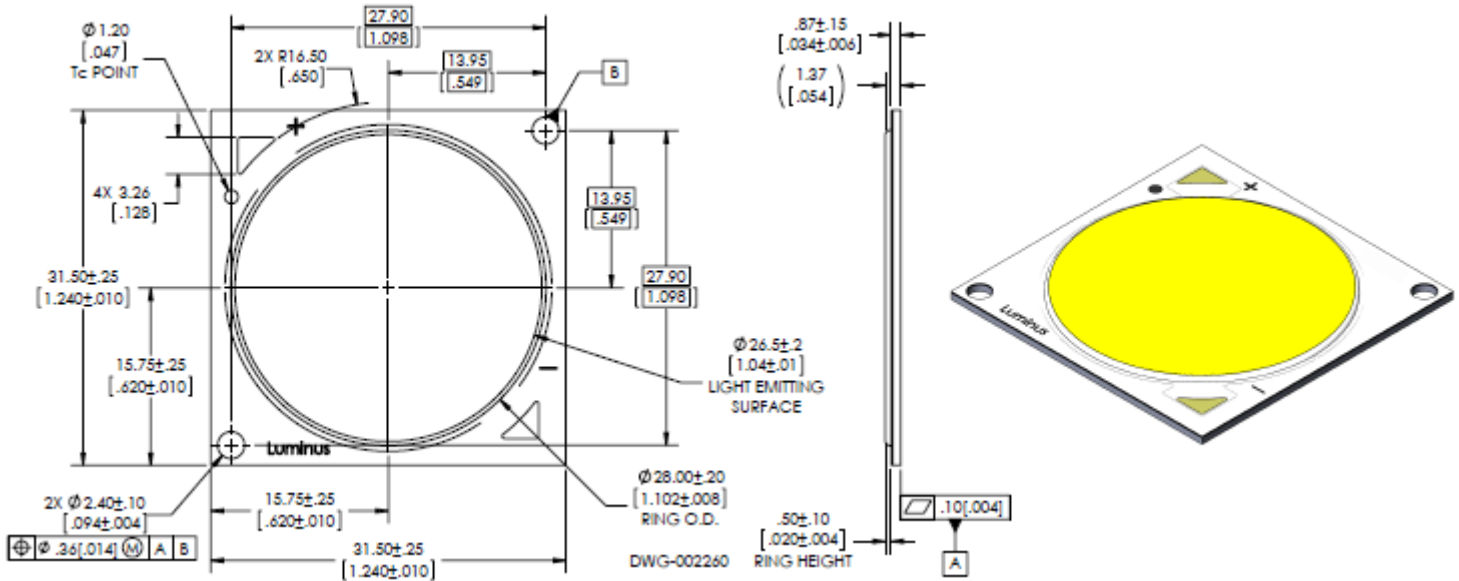
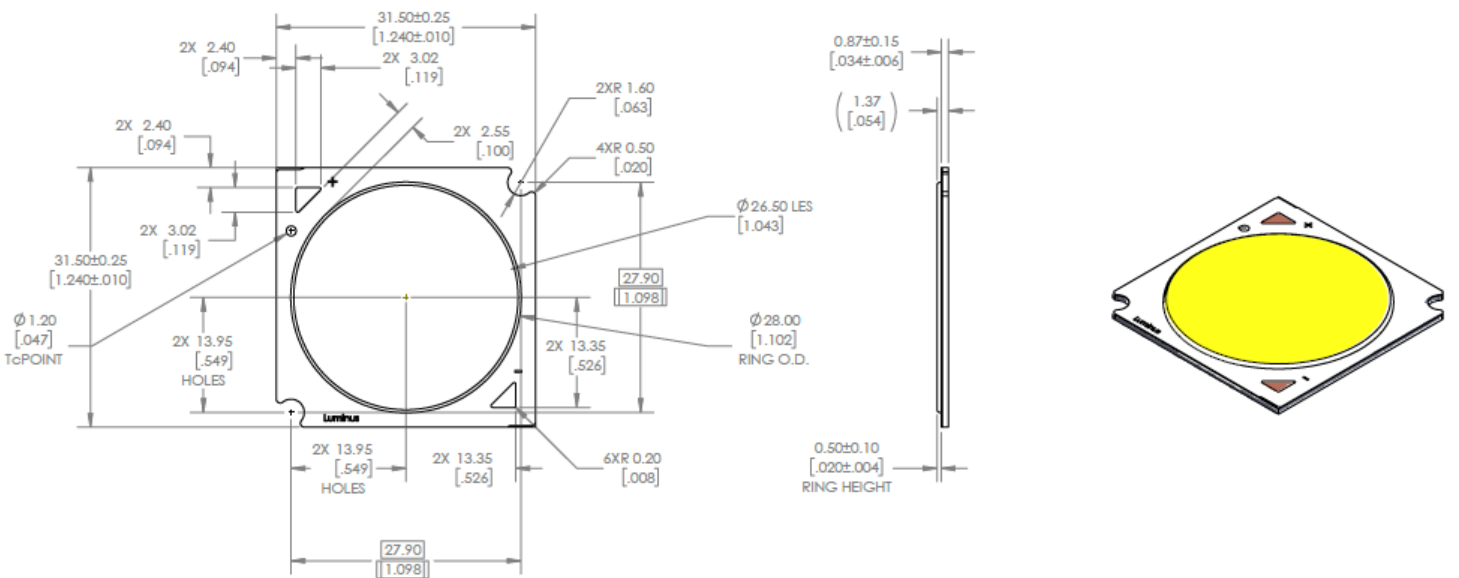
Change in CIE_y vs. Junction Temperature (3100K)

CVM-18 Optical & Electrical Characteristics
Relative Output Flux vs. Forward Current @ 85°C

Forward Current vs. Forward Voltage @ 85°C

Relative Output Flux vs. Junction Temperature

Change in Voltage vs. Junction Temperature

Change in CIE_x vs. Junction Temperature (3100K)

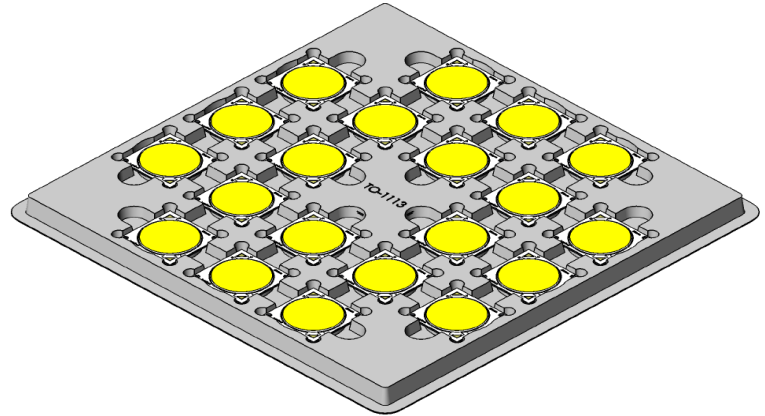
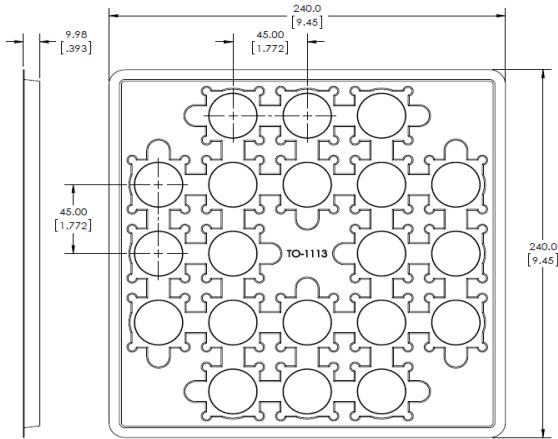
Change in CIE_y vs. Junction Temperature (3100K)

CVM-27 Optical & Electrical Characteristics
Relative Output Flux vs. Forward Current @ 85°C

Forward Current vs. Forward Voltage @ 85°C

Relative Output Flux vs. Junction Temperature

Change in Voltage vs. Junction Temperature

Change in CIE_x vs. Junction Temperature (3100K)

Change in CIE_y vs. Junction Temperature (3100K)

CVM-32 Optical & Electrical Characteristics
Relative Output Flux vs. Forward Current @ 85°C

Forward Current vs. Forward Voltage @ 85°C

Relative Output Flux vs. Junction Temperature

Change in Voltage vs. Junction Temperature

Change in CIE_x vs. Junction Temperature (3100K)

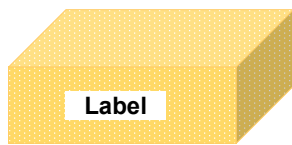
Change in CIE_y vs. Junction Temperature (3100K)

CVM Optical & Electrical Characteristics
Typical Spectrum (3150K)

Typical Spectrum (5600K)

Typical Polar Radiation Pattern

Typical Angular Radiation Pattern

Mechanical Dimensions (CVM-27-AA00)

Mechanical Dimensions (CVM-27-AB00)

Shipping Container (CVM-27)

100 pcs per box
Each bag is boxed for
easier storage/ stacking

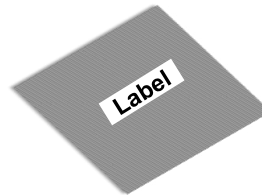

Trays are sealed in
an anti-static bag



20 pcs per tray
5 trays are stacked together
with separate cover

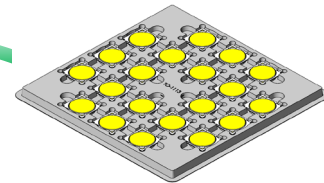

Luminus Label Model:

		Luminus Devices Inc		RoHS Compliant
XXXXXX-XX-XX (Manufacturer Part Number & Bin Kits)		Rev XX		
Bar code		Bar code		
XXX-XX-XX-XX-XX-XXXX-XX-X (Customer Part Number)				
XXXXXXXXXXXXXXXX (Box ID)		Qty: XX		
Bar code		Bar code		

Mechanical Dimensions (CVM-32-AC00)

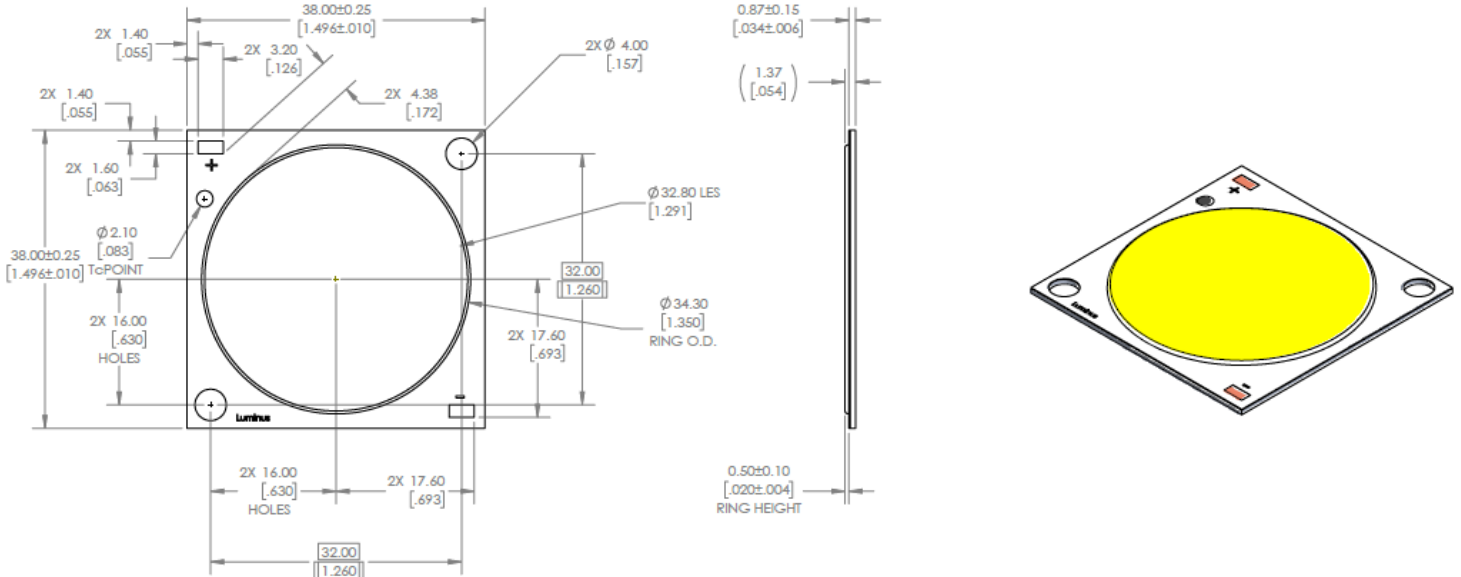

Shipping Container (CVM-32-AC00)

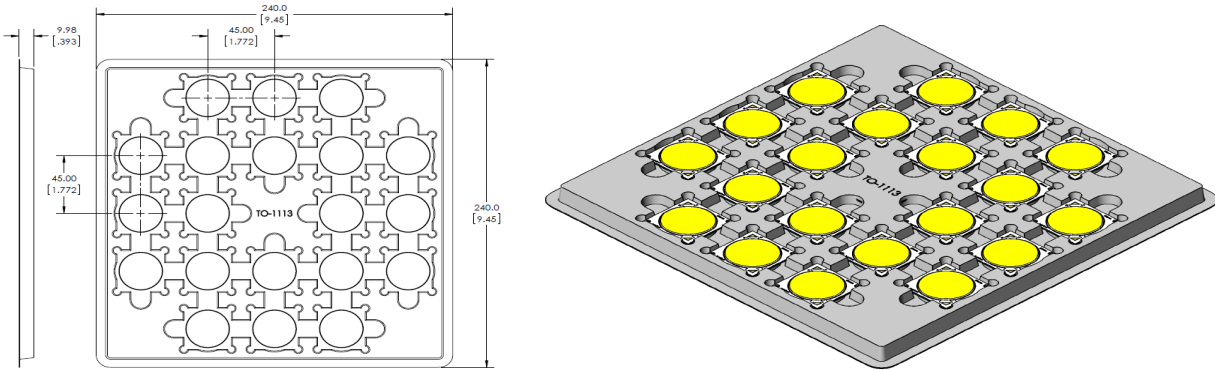

60 pcs per box
Each bag is boxed for easier storage/ stacking

Trays are sealed in an anti-static bag

20 pcs per tray
3 trays are stacked together with separate cover



Luminus Label Model:

	Luminus Devices Inc	RoHS Compliant
XXXXXX-XX-XX (Manufacturer Part Number & Bin Kits)	Rev XX	
Bar code	Bar code	
XXX-XX-XX-XX-XX-XXXX-XX-X (Customer Part Number)	Qty: XX	
XXXXXXXXXXXXXXXX (Box ID)	Bar code	

Handling Notes for Luminus COBs

Luminus products are designed for robust performance in general lighting application. However, care must be taken when handling and assembling the LEDs into their fixtures. To avoid damaging Luminus COBs please follow these guidelines.

The following is an overview of the application notes detailing some of the practices to follow when working with these devices. More detailed information is available on the Luminus web site at www.luminus.com.

General Handling

Devices are made to be lifted or carried with tweezers on two adjacent corners opposite the contact pads. At no time should the devices be handled by or should anything come in contact with the light emitting surface (LES) area. This area includes the yellow colored circular area and the ring surrounding it. There are electrical connections under the LES which if damaged will cause the device to fail.

In addition, the ring frame itself should not be used for moving, lifting or carrying the device. Also do not attach any optics or mechanical holders to the ring as it is not capable to handle the mechanical stress.

Static Electricity

Luminus COBs are electronic devices which can be damaged by electrostatic discharge (ESD). Please use appropriate measures to assure the devices do not experience ESD during their handling and or storage. ESD protection guidelines should be used at all times when working with Luminus COBs.

Storage: Luminus products are delivered in ESD shielded bags and should be stored in these bags until used.

Assembly: Individuals handling Luminus COBs during assembly should be trained in ESD protection practices. Assemblers should maintain constant conductive contact with a path to ground by means of a wrist strap, ankle straps, mat or other ESD protection system.

Transporting: When transporting the devices from one assembly area to another, ESD shielded carts and carriers should be used.

Electrical Contact

Luminus COBs are designed with contact pads on their top surface. These pads are clearly marked with + and – polarity. Wires can be soldered to the contact pads for electrical connections or other solderless connector products are available.

If wires are being soldered to the COB product, we recommend attaching these wires prior to mounting the devices to a heat sink. Please contact Luminus for specific recommendations on how to solder wires if not familiar with the standard practice. Luminus can also offer design recommendations for jigs to allow easily soldering multiple products in rapid succession.

Chemical Compatibility

The resin material used to form the LES can get hydrocarbons from the surrounding environment. As a result, certain chemical compounds are not recommended for use with the Luminus products. Use of these compounds can cause damage to the light output of the device and may permanently damage the device. Please refer to www.luminus.com for a list of the compounds not recommended for use with the Luminus COB products.

Thermal Interface Material (TIM)

Proper thermal management is critical for successful operation of any LED system. Excess operating temperature can reduce the light output of the device. And excessive heating can cause permanent damage to the device. Proper TIM material is a crucial component for effective heat transfer away from the LED during normal operation. Please refer to www.luminus.com for specific recommendations for TIM solutions.

单击下面可查看定价，库存，交付和生命周期等信息

[>>Luminus Devices\(朗明纳斯\)](#)