



MBR2020CT THRU MBR20100CT

SCHOTTKY BARRIER RECTIFIER

Reverse Voltage - 20 to 100 Volts Forward Current - 20.0 Amperes

TO-220AB

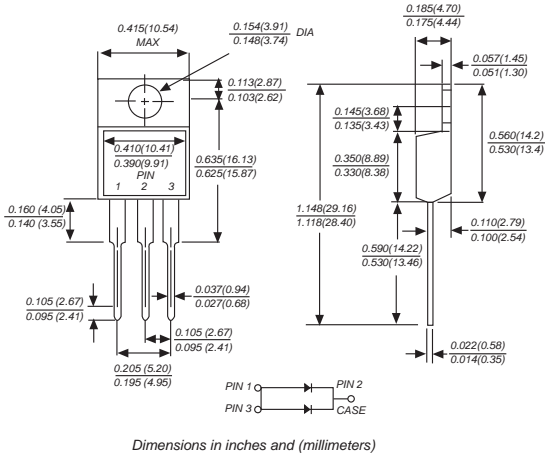

FEATURES

- ◆ The plastic package carries Underwriters Laboratory Flammability Classification 94V-0
- ◆ Construction utilizes void-free molded plastic technique
- ◆ Low reverse leakage
- ◆ High forward surge current capability
- ◆ High temperature soldering guaranteed: 250°C, 0.25" (6.35mm) from case for 10 seconds

MECHANICAL DATA

Case: TO-220AB molded plastic body
Terminals: Leads solderable per MIL-STD-750, Method 2026
Polarity: As marked
Mounting Position: Any
Weight: 0.08 ounce, 2.24 grams

MAXIMUM RATINGS AND ELECTRICAL CHARACTERISTICS

Ratings at 25°C ambient temperature unless otherwise specified.
 Single phase half-wave 60Hz, resistive or inductive load, for capacitive load current derate by 20%.

MDD Catalog Number	SYMBOLS	MBR 2020CT	MBR 2030CT	MBR 2040CT	MBR 2045CT	MBR 2050CT	MBR 2060CT	MBR 2070CT	MBR 2080CT	MBR 2090CT	MBR 20100CT	UNITS
Maximum repetitive peak reverse voltage	V_{RRM}	20	30	40	45	50	60	70	80	90	100	VOLTS
Maximum RMS voltage	V_{RMS}	14	21	28	32	35	42	49	56	63	70	VOLTS
Maximum DC blocking voltage	V_{DC}	20	30	40	45	50	60	70	80	90	100	VOLTS
Maximum average forward rectified current at T_c (see fig.1)	$I_{(AV)}$	20.0										Amps
Peak forward surge current 8.3ms single half sine-wave superimposed on rated load (JEDEC Method)	I_{FSM}	150.0										Amps
Maximum instantaneous forward voltage at 10.0A	V_F	0.55			0.75			0.85			Volts	
Maximum DC reverse current at rated DC blocking voltage $T_A=25^\circ C$ $T_A=100^\circ C$	I_R	1.0					50.0					mA
Typical junction capacitance (NOTE 1)	C_J	550					450					pF
Typical thermal resistance (NOTE 2)	$R_{\theta JC}$	2.0										°C/W
Operating junction temperature range	T_J	-50 to +125					-50 to +150					°C
Storage temperature range	T_{STG}	-50 to +150										°C

Note: 1. Measured at 1MHz and applied reverse voltage of 4.0V D.C.

2. Thermal resistance from junction to case



RATINGS AND CHARACTERISTIC CURVES MBR2020CT THRU MBR20100CT

AVERAGE FORWARD RECTIFIED CURRENT, AMPERES

FIG. 1- FORWARD CURRENT DERATING CURVE

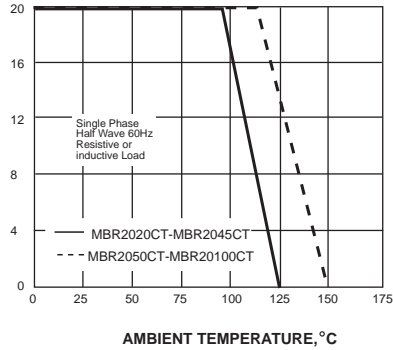

PEAK FORWARD SURGE CURRENT, AMPERES

FIG. 2-MAXIMUM NON-REPETITIVE PEAK FORWARD SURGE CURRENT

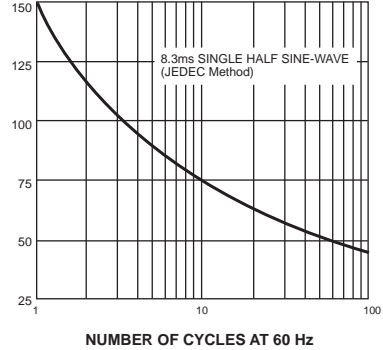
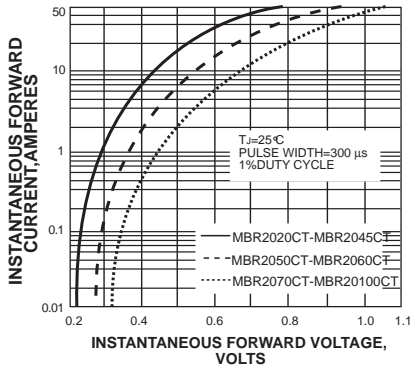
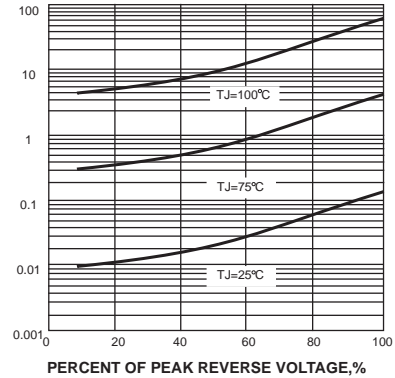

FIG. 3-TYPICAL INSTANTANEOUS FORWARD CHARACTERISTICS



INSTANTANEOUS REVERSE CURRENT, MILLIAMPERES

FIG. 4-TYPICAL REVERSE CHARACTERISTICS



JUNCTION CAPACITANCE, pF

FIG. 5-TYPICAL JUNCTION CAPACITANCE

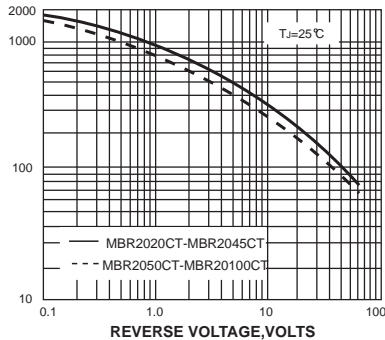

TRANSIENT THERMAL IMPEDANCE, °C/W

FIG. 6-TYPICAL TRANSIENT THERMAL IMPEDANCE

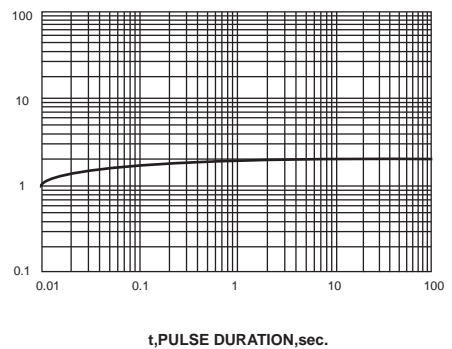

The cruve graph is for reference only, can't be the basis for judgment(曲线图仅供参考)!



单击下面可查看定价，库存，交付和生命周期等信息

[>>MDD\(辰达行\)](#)