

## Low Power Consumption, High Speed 200mA LDO Regulator - 10.5V Input

## ■ GENERAL DESCRIPTION

Even the XC6505 series is a low power consumption such as  $5.5\mu\text{A}$ , the IC is a high speed CMOS LDO regulator that features high accurate, low noise, high ripple rejection, and low dropout. The series consists of a voltage reference, an error amplifier, a driver transistor, a current limiter, a phase compensation circuit and a thermal shutdown circuit.

The CE function enables the circuit to be in stand-by mode by inputting low level signal. In the stand-by mode, the series enables the electric charge at the output capacitor  $C_L$  to be discharged via the internal switch, and as a result the  $V_{\text{OUT}}$  pin quickly returns to the  $V_{\text{SS}}$  level.

The over current protection circuit and the thermal shutdown circuit are built-in. These two protection circuits will operate when the output current reaches current limit level or the junction temperature reaches temperature detection level.

## ■ APPLICATIONS

- Car navigation systems
- Car audios
- Digital still cameras / Camcorders

## ■ FEATURES

<b>Maximum Output Current</b>	:	200mA
<b>Input Voltage</b>	:	1.7V ~ 10.5V
<b>Output Voltage</b>	:	1.5V ~ 8.0V (0.1V increments)
<b>Accuracy</b>	:	$\pm 1.0\%$ (2.0V~8.0V) $\pm 20\text{mV}$ (1.5V~1.9V)
<b>Temperature Stability</b>	:	$\pm 30\text{ppm}/^\circ\text{C}$
<b>Dropout Voltage</b>	:	190mV @ $V_{\text{OUT}}=3.3\text{V}$ , $I_{\text{OUT}}=100\text{mA}$
<b>Low Power Consumption</b>	:	5.5 $\mu\text{A}$ (TYP.)
<b>Chip Enable(CE)</b>	:	Active High 0.1 $\mu\text{A}$ (Stand-by)
<b>High Ripple Rejection</b>	:	60dB@1kHz
<b>Protection</b>	:	Current Limiter (300mA, TYP.) Short circuit protection (110mA, TYP.) Thermal Shutdown
<b>Operating Ambient Temperature</b>	:	-40~+105°C
<b>Packages</b>	:	USP-6C, SOT-25, SOT-89-5
<b>Environmentally Friendly</b>	:	EU RoHS Compliant, Pb Free

## ■ TYPICAL APPLICATION CIRCUIT    ■ TYPICAL PERFORMANCE CHARACTERISTICS

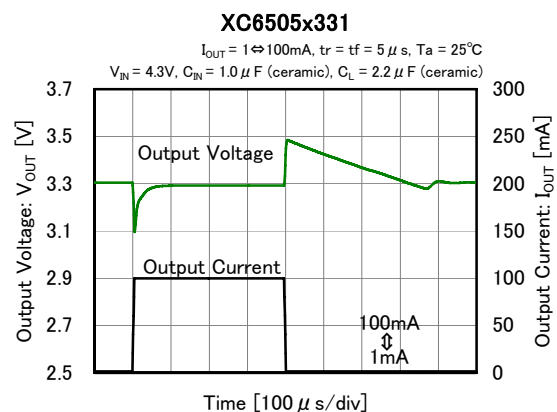
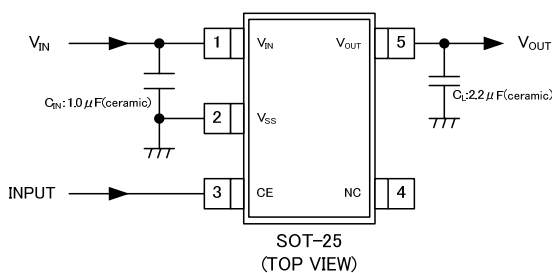

## ■ PIN CONFIGURATION

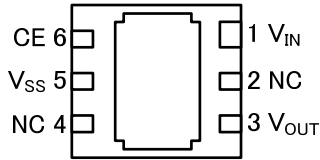

USP-6C  
(BOTTOM VIEW)

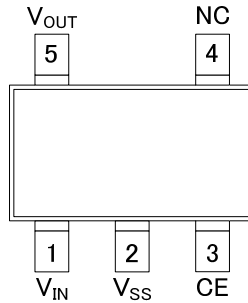

SOT-25  
(TOP VIEW)

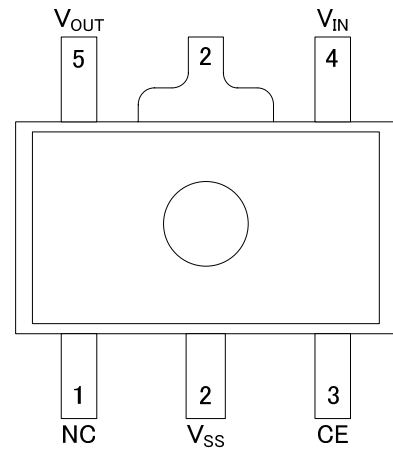

SOT-89-5  
(TOP VIEW)

\*The dissipation pad for the USP-6C package should be solder-plated in recommended mount pattern and metal masking so as to enhance mounting strength and heat release.

If the pad needs to be connected to other pins, it should be connected to the V<sub>SS</sub> (No. 5) pin.

## ■ PIN ASSIGNMENT

PIN NUMBER			PIN NAME	FUNCTIONS
USP-6C	SOT-25	SOT-89-5		
1	1	4	V <sub>IN</sub>	Power Input
3	5	5	V <sub>OUT</sub>	Output
5	2	2	V <sub>SS</sub>	Ground
6	3	3	CE	ON/OFF Control
2,4	4	1	NC	No connection

## ■ PRODUCT CLASSIFICATION

### ● Ordering Information

XC6505①②③④⑤⑥-⑦<sup>(\*)</sup>

DESIGNATOR	ITEM	SYMBOL	DESCRIPTION
①	Type of Regulators	A	without CE Pull-down, without C <sub>L</sub> Discharge
		B (The Recommended Type)	without CE Pull-down, with C <sub>L</sub> Discharge
②③	Output Voltage	15~80	e.g. 2.8V → ②=2、③=8
④	Output Accuracy	1	±1.0% (2.0V~8.0V) ±20mV (1.5V~1.9V)
⑤⑥-⑦	Packages (Order Unit)	ER-G	USP-6C (3,000/Reel)
		MR-G	SOT-25 (3,000/Reel)
		PR-G	SOT-89-5 (1,000/Reel)

<sup>(\*)</sup> The "-G" suffix indicates that the products are Halogen and Antimony free as well as being fully EU RoHS compliant.

<sup>(2)</sup> With CE Pull-down, please contact your local Torex sales office or representative.

## ■ BLOCK DIAGRAMS

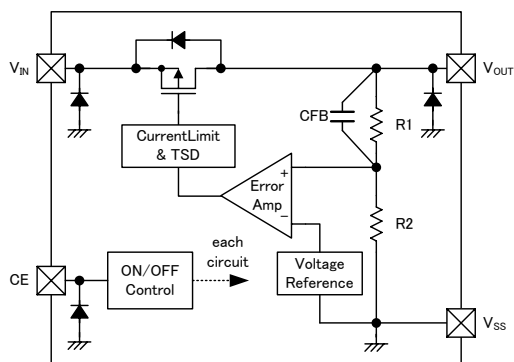

XC6505A Series

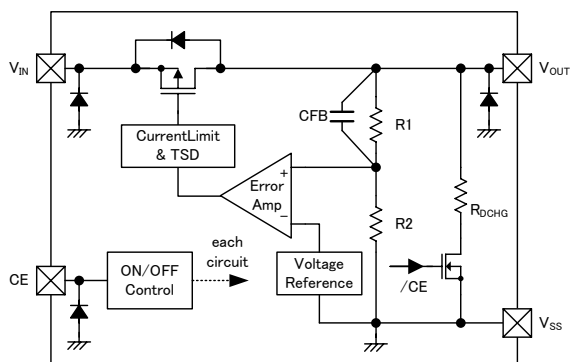

XC6505B Series

\* Diodes inside the circuits are ESD protection diodes and parasitic diodes.

## ■ ABSOLUTE MAXIMUM RATINGS

Ta=25°C

PARAMETER	SYMBOL	RATINGS	UNITS
Input Voltage	V <sub>IN</sub>	V <sub>SS</sub> -0.3~+12.0	V
Output Current	I <sub>OUT</sub>	450 <sup>(*1)</sup>	mA
Output Voltage	V <sub>OUT</sub>	V <sub>SS</sub> -0.3~V <sub>IN</sub> +0.3	V
CE Input Voltage	V <sub>CE</sub>	V <sub>SS</sub> -0.3~+12.0	V
Power Dissipation	USP-6C	Pd	120
	SOT-25		250
	SOT-89-5		500
Power Dissipation <sup>(*2)</sup> (PCB mounted)	USP-6C	Pd	1000
	SOT-25		600
	SOT-89-5		1300
Operating Temperature Range	Topr	-40~+105	°C
Storage Temperature Range	Tstg	-55~+125	°C

(\*1) Please use within the range of Pd > (V<sub>IN</sub>-V<sub>OUT</sub>) × I<sub>OUT</sub>

(\*2) This is a reference data taken by using the test board. Please refer to page 20 for details.

## ELECTRICAL CHARACTERISTICS

### ●XC6505A/B Series

Ta=25°C

PARAMETER	SYMBOL	CONDITIONS	MIN.	TYP.	MAX.	UNIT	CIRCUIT
Output Voltage	V <sub>OUT(E)</sub> <sup>(*2)</sup>	V <sub>OUT(T)</sub> <sup>(*3)</sup> < 2.0V V <sub>CE</sub> =V <sub>IN</sub> , I <sub>OUT</sub> =10mA	-0.02 <sup>(*4)</sup>	V <sub>OUT(T)</sub>	+0.02 <sup>(*4)</sup>	V	①
		V <sub>OUT(T)</sub> ≥ 2.0V V <sub>CE</sub> =V <sub>IN</sub> , I <sub>OUT</sub> =10mA	× 0.99 <sup>(*4)</sup>		× 1.01 <sup>(*4)</sup>		
Maximum Output Current	I <sub>OUTMAX</sub>	V <sub>OUT(T)</sub> ≤ 2.0V V <sub>CE</sub> =V <sub>IN</sub> =V <sub>OUT(T)</sub> + 1.5V	200	-	-	mA	①
		V <sub>OUT(T)</sub> > 2.0V V <sub>CE</sub> =V <sub>IN</sub> =V <sub>OUT(T)</sub> + 1.0V					
Load Regulation	ΔV <sub>OUT</sub>	V <sub>CE</sub> =V <sub>IN</sub> , 0.1mA ≤ I <sub>OUT</sub> ≤ 100mA	-	20	40	mV	①
Dropout Voltage <sup>(*5)</sup>	V <sub>dif</sub>	V <sub>CE</sub> =V <sub>IN</sub> , I <sub>OUT</sub> =100mA	Refer to VOLTAGE CHART E-1			mV	①
Supply Current	I <sub>DD</sub>	V <sub>OUT(T)</sub> ≤ 5.0V V <sub>CE</sub> =V <sub>IN</sub> , I <sub>OUT</sub> =0mA	-	5.5	8.0	μA	②
		V <sub>OUT(T)</sub> > 5.0V V <sub>CE</sub> =V <sub>IN</sub> , I <sub>OUT</sub> =0mA	-	6.0	10.0		
Stand-by Current	I <sub>STB</sub>	V <sub>IN</sub> =10.5V, V <sub>CE</sub> =V <sub>SS</sub>	-	0.01	0.1	μA	②
Line Regulation	ΔV <sub>OUT</sub> / (ΔV <sub>IN</sub> ·V <sub>OUT</sub> )	V <sub>OUT(T)</sub> +0.5V ≤ V <sub>IN</sub> ≤ 10.5V, V <sub>CE</sub> =V <sub>IN</sub> , I <sub>OUT</sub> =30mA	-	0.1	0.2	%/V	①
Input Voltage	V <sub>IN</sub>		1.7	-	10.5	V	①
Output Voltage Temperature Characteristics	ΔV <sub>OUT</sub> / (ΔT <sub>opr</sub> ·V <sub>OUT</sub> )	V <sub>CE</sub> =V <sub>IN</sub> , I <sub>OUT</sub> =30mA -40°C ≤ T <sub>opr</sub> ≤ 105°C	-	±30	-	ppm/ °C	①
Ripple Rejection Rate	PSRR	V <sub>IN</sub> ={V <sub>OUT(T)</sub> +1.0}V <sub>DC</sub> +0.5Vp-p <sub>AC</sub> V <sub>CE</sub> =V <sub>IN</sub> , I <sub>OUT</sub> =30mA, f=1kHz	Refer to VOLTAGE CHART E-2			dB	③
Limit Current	I <sub>LIM</sub>	V <sub>OUT(T)</sub> ≤ 2.0V V <sub>CE</sub> =V <sub>IN</sub> =V <sub>OUT(T)</sub> + 1.5V, V <sub>OUT</sub> =V <sub>OUT(T)</sub> ×0.95	210	300	-	mA	①
		V <sub>OUT(T)</sub> > 2.0V V <sub>CE</sub> =V <sub>IN</sub> =V <sub>OUT(T)</sub> + 1.0V, V <sub>OUT</sub> =V <sub>OUT(T)</sub> ×0.95					
Short Current	I <sub>SHORT</sub>	V <sub>CE</sub> =V <sub>IN</sub> , Short V <sub>OUT</sub> to V <sub>SS</sub> level	-	110	-	mA	①
CE High Level Voltage	V <sub>CEH</sub>		1.2	-	V <sub>IN</sub>	V	①
CE Low Level Voltage	V <sub>CEL</sub>		V <sub>SS</sub>	-	0.45	V	①
CE High Level Current	I <sub>CEH</sub>	V <sub>IN</sub> =V <sub>CE</sub> =10.5V	-0.1	-	0.1	μA	①
CE Low Level Current	I <sub>CEL</sub>	V <sub>CE</sub> =V <sub>SS</sub>	-0.1	-	0.1	μA	①
CL Auto-Discharge Resistance <sup>(*8)</sup>	R <sub>DCHG</sub>	V <sub>IN</sub> =10.5V, V <sub>CE</sub> =V <sub>SS</sub> , V <sub>OUT</sub> =5.0V	300	400	500	Ω	①
Thermal Shutdown Detect Temperature	T <sub>TSD</sub>	Junction Temperature	-	150	-	°C	-
Thermal Shutdown Release Temperature	T <sub>TSR</sub>	Junction Temperature	-	125	-	°C	-
Thermal Shutdown Hysteresis Width	T <sub>HYS</sub>	T <sub>TSD</sub> - T <sub>TSR</sub>	-	25	-	°C	-

#### NOTE:

(\* 1) Unless otherwise stated, input voltage is V<sub>IN</sub>=V<sub>OUT(T)</sub><sup>(\*3)</sup>+1.0V.

(\* 2) V<sub>OUT(E)</sub> is defined as output voltages when an amply stabilized V<sub>OUT(T)</sub>+1.0V is supplied to the V<sub>IN</sub> pin while maintaining a certain I<sub>OUT</sub>.

(\* 3) V<sub>OUT(T)</sub> is nominal output voltage

(\* 4) For the specified value of the effective output voltage V<sub>OUT(E)</sub> of each nominal output voltage, refer to VOLTAGE CHART E-0.

(\* 5) V<sub>dif</sub> = V<sub>IN1</sub><sup>(\*6)</sup>-V<sub>OUT1</sub><sup>(\*7)</sup>

(\* 6) V<sub>IN1</sub> is the input voltage when V<sub>OUT1</sub> appears at the V<sub>OUT</sub> pin while input voltage is gradually decreased.

(\* 7) V<sub>OUT1</sub> equals 98% of the output voltage when amply stabilized V<sub>OUT(T)</sub>+1.0V are supplied to the V<sub>IN</sub> pin.

(\* 8) R<sub>DCHG</sub> is effective for the XC6505B Series only. The XC6505A Series discharges only through the resistance R1 + R2 in the block diagram.

**■ ELECTRICAL CHARACTERISTICS (Continued)**

NOMINAL VOLTAGE (V)	E-0		E-1		E-2	NOMINAL VOLTAGE (V)	E-0		E-1		E-2	
	OUTPUT VOLTAGE (V)		DROPOUT VOLTAGE (mV)		Ripple Rejection Rate (dB)		OUTPUT VOLTAGE (V)		DROPOUT VOLTAGE (mV)		Ripple Rejection Rate (dB)	
	$V_{OUT(E)}$		$V_{dif}$		PSRR		$V_{OUT(E)}$		$V_{dif}$		PSRR	
$V_{OUT(T)}$	MIN.	MAX.	TYP.	MAX.	TYP.	$V_{OUT(T)}$	MIN.	MAX.	TYP.	MAX.	TYP.	
1.5	1.480	1.520	430	540	60	5.0	4.950	5.050	140	185	50	
1.6	1.580	1.620	400	490		5.1	5.049	5.151	140	185		
1.7	1.680	1.720	370	450		5.2	5.148	5.252	140	185		
1.8	1.780	1.820	350	420		5.3	5.247	5.353	140	185		
1.9	1.880	1.920	330	400		5.4	5.346	5.454	140	185		
2.0	1.980	2.020	300	370		5.5	5.445	5.555	140	185		
2.1	2.079	2.121	280	350		5.6	5.544	5.656	140	185		
2.2	2.178	2.222	260	330		5.7	5.643	5.757	140	185		
2.3	2.277	2.323	240	310		5.8	5.742	5.858	130	180		
2.4	2.376	2.424	230	290		5.9	5.841	5.959	130	180		
2.5	2.475	2.525	220	280		6.0	5.940	6.060	130	180		
2.6	2.574	2.626	210	270		6.1	6.039	6.161	130	180		
2.7	2.673	2.727	200	260		6.2	6.138	6.262	130	180		
2.8	2.772	2.828	200	260		6.3	6.237	6.363	130	180		
2.9	2.871	2.929	200	250		6.4	6.336	6.464	130	180		
3.0	2.970	3.030	200	250		6.5	6.435	6.565	120	175		
3.1	3.069	3.131	190	240		6.6	6.534	6.666	120	175		
3.2	3.168	3.232	190	240		6.7	6.633	6.767	120	175		
3.3	3.267	3.333	190	240		6.8	6.732	6.868	120	175		
3.4	3.366	3.434	180	230		6.9	6.831	6.969	120	175		
3.5	3.465	3.535	180	230		7.0	6.930	7.070	120	175		
3.6	3.564	3.636	170	220		7.1	7.029	7.171	120	175		
3.7	3.663	3.737	170	220		7.2	7.128	7.272	110	170		
3.8	3.762	3.838	170	210		7.3	7.227	7.373	110	170		
3.9	3.861	3.939	170	210		7.4	7.326	7.474	110	170		
4.0	3.960	4.040	170	210		7.5	7.425	7.575	110	170		
4.1	4.059	4.141	170	210		7.6	7.524	7.676	110	170		
4.2	4.158	4.242	160	200		7.7	7.623	7.777	110	170		
4.3	4.257	4.343	160	200		7.8	7.722	7.878	110	170		
4.4	4.356	4.444	160	200		7.9	7.821	7.979	110	170		
4.5	4.455	4.545	160	200		8.0	7.920	8.080	110	170		
4.6	4.554	4.646	150	190								
4.7	4.653	4.747	150	190								
4.8	4.752	4.848	150	190								
4.9	4.851	4.949	150	190								

## OPERATIONAL EXPLANATION

The voltage divided by resistors R1 & R2 is compared with the internal reference voltage by the error amplifier. The P-channel MOSFET which is connected to the V<sub>OUT</sub> pin is then driven by the subsequent output signal. The output voltage at the V<sub>OUT</sub> pin is controlled and stabilized by a system of negative feedback. The current limit circuit and short protection circuit operate in relation to the level of output current and heat dissipation. Further, the IC's internal circuitry can be shutdown via the CE pin signal.

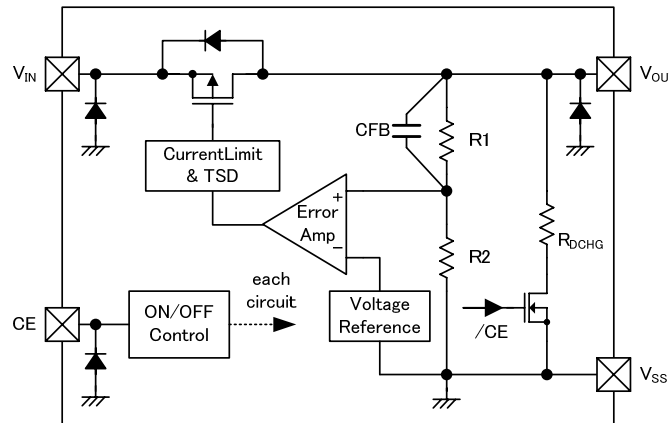

XC6505B Series

### <CE Pin>

The XC6505 Series is able to shut down the regulator circuit using the CE pin signal. In the shutdown state, the V<sub>OUT</sub> pin is pulled down by R1 and R2 to the V<sub>SS</sub> level. In the XC6505B Series, the C<sub>L</sub> discharge resistance is connected in parallel with R1 and R2 when power is supplied to V<sub>IN</sub>, shortening the time until the V<sub>SS</sub> level is reached. Operation is unstable when the CE pin is open, and thus the V<sub>IN</sub> voltage or the V<sub>SS</sub> voltage should be input into the CE pin. Although the logic is fixed and operation is normal as long the voltage satisfies the CE pin voltage specification, inputting an intermediate voltage may cause the supply current to increase due to the flowthrough current in the IC internal circuit.

### <C<sub>L</sub> Auto-Discharge Function>

The XC6505B type is capable of high-speed discharge of the charge that collects on the output capacitor (C<sub>L</sub> below). This is accomplished by the N-channel MOSFET connected between the V<sub>OUT</sub> and V<sub>SS</sub> pins in the block diagram, and takes place when the L-level signal (IC internal circuit shutdown signal) of the CE pin is input. The C<sub>L</sub> discharge resistance is set to 400 Ω (when V<sub>IN</sub> = 10.5 V, V<sub>OUT</sub> = 5.0 V typical). The C<sub>L</sub> discharge time is determined by this C<sub>L</sub> discharge resistance and C<sub>L</sub>. Letting the time constant of the C<sub>L</sub> discharge resistance R<sub>DCHG</sub> and C<sub>L</sub> be τ (τ = C × R), the output voltage after discharge by the N-channel MOSFET can be obtained from the CR discharge equation below.

$$V = V_{OUT(E)} \times e^{-t/\tau} \quad \text{or} \quad t = \tau \times \ln(V_{OUT(E)}/V)$$

V: Output voltage after discharge

V<sub>OUT(E)</sub>: Output voltage

t: Discharge time

τ : C<sub>L</sub> auto-discharge resistance R<sub>DCHG</sub> × C<sub>L</sub> Output capacitor value C<sub>L</sub>

### <Current Limiter, Short-Circuit Protection>

The XC6505 series' fold-back circuit operates as an output current limiter and a short protection circuit for the output pin. When the load current reaches the current limit level, the fixed current limiter circuit operates and output voltage drops. When the output pin is short-circuited to the V<sub>SS</sub> pin, the current falls and reaches about 110mA.

### <Thermal Shutdown>

The XC6505 Series has an internal thermal shutdown (TSD) circuit for protection against overheating. When the junction temperature reaches the detection temperature, the driver transistor is forcibly turned off. When the junction temperature falls to the release temperature with the driver transistor still in the off state, the driver transistor turns on (automatic recovery) and restarts regulator operation.

## ■ OPERATIONAL EXPLANATION

<Input/output capacitor>

The XC6505 Series uses an output capacitor ( $C_L$ ) for phase compensation. For this reason, if a small capacitor or low withstand-voltage capacitor is used for  $C_L$ , DC bias dependence causes a smaller capacitance value, and phase shifting that results in unstable operation may occur. Exercise caution when selecting the capacitor. Recommended capacitances for the XC6505 Series are shown below.

For the input capacitor ( $C_{IN}$ ), select a capacitance of 1.0  $\mu$ F or higher to stabilize the input power.

Table1 : Recommended  $C_L$  capacitances

Manufacturer	Product Number	Capacity [ $\mu$ F]	Size Unit		Size L x W [mm]	Withstand Voltage [V]	Temperature Range [ $^{\circ}$ C]
			JIS	EIA			
TDK	C2012X7R1C225K	2.2	2012	0805	2.0 x 1.25	16	-55 ~ 125
MURATA	GRM21BR71C225K	2.2	2012	0805	2.0 x 1.25	16	-55 ~ 125
TAIYO YUDEN	EMK212B7225K	2.2	2012	0805	2.0 x 1.25	16	-55 ~ 125

## ■ NOTES ON USE

1. For temporary, transitional voltage drop or voltage rising phenomenon, the IC is liable to malfunction should the ratings be exceeded.
2. Where wiring impedance is high, operations may become unstable due to noise and/or phase lag depending on output current. Please wire the input capacitor ( $C_{IN}$ ) and the output capacitor ( $C_L$ ) as close to the IC as possible.
3. If the input voltage fluctuates by 1.5 V or more and is at a slope of 0.1 V/ $\mu$ s or more, output voltage undershoot may become more pronounced. In this case, use a larger input capacitor ( $C_{IN}$ ) or otherwise adjust so that the through rate is less than 0.1 V/ $\mu$ s.
4. If a small capacitor is used for the output capacitor ( $C_L$  below), capacitance loss due to DC bias dependence will become more pronounced. This will increase the tendency for phase shifting to occur, resulting in unstable operation. Test thoroughly before using.  
For guidelines for the  $C_L$  capacitance, check the XC6505 recommended capacitance characteristics (refer to Operational Explanation, Input/Output Capacitors).
5. Torex places an importance on improving our products and its reliability.  
However, by any possibility, we would request user fail-safe design and post-aging treatment on system or equipment.

## TEST CIRCUITS

### ● Circuit ①

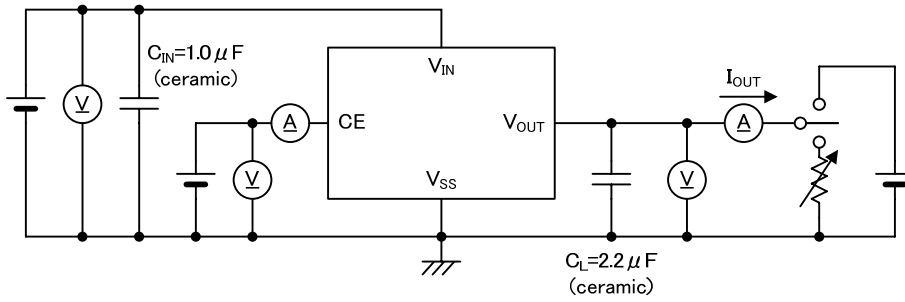

### ● Circuit ②

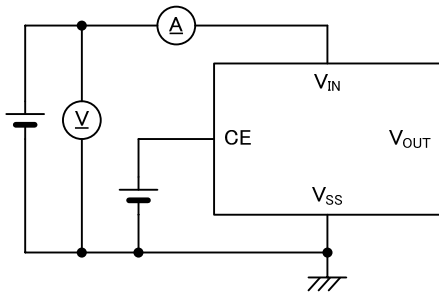

### ● Circuit ③

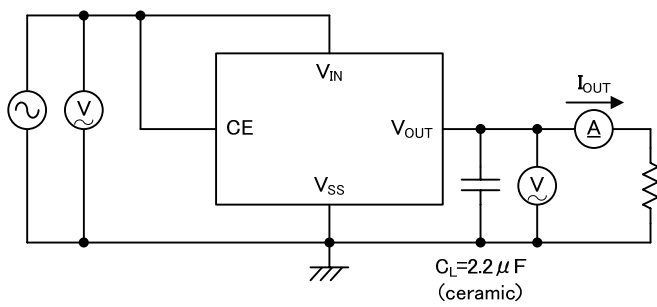



## TYPICAL PERFORMANCE CHARACTERISTICS

\*CE Voltage condition: Unless otherwise stated,  $V_{CE}=V_{IN}$

### (1) Output Voltage vs. Output Current

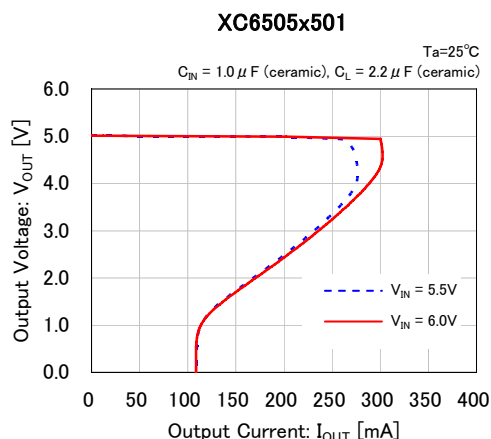
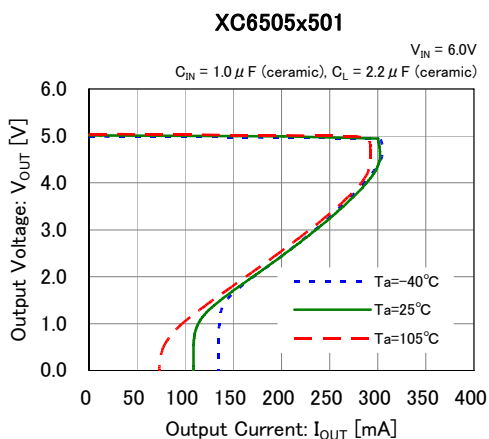
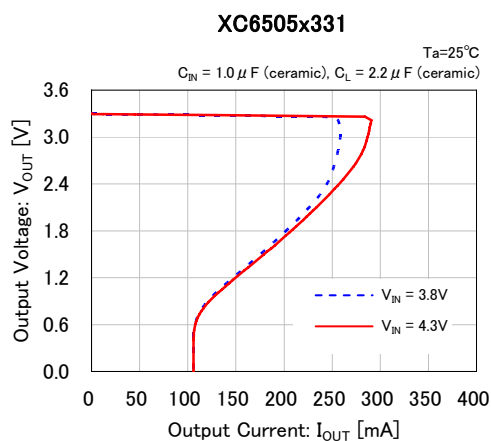
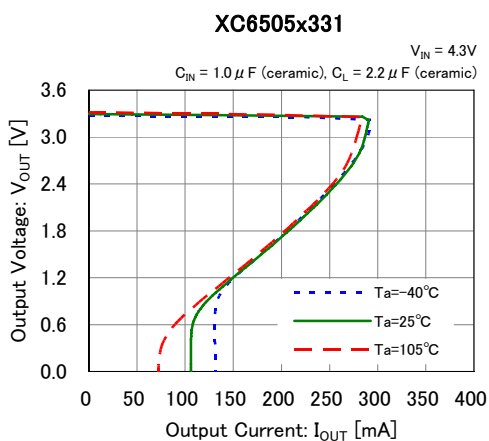
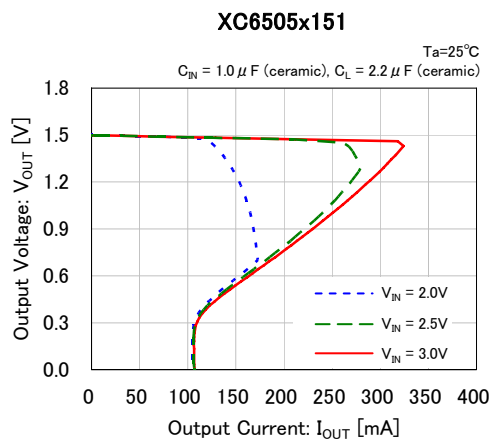
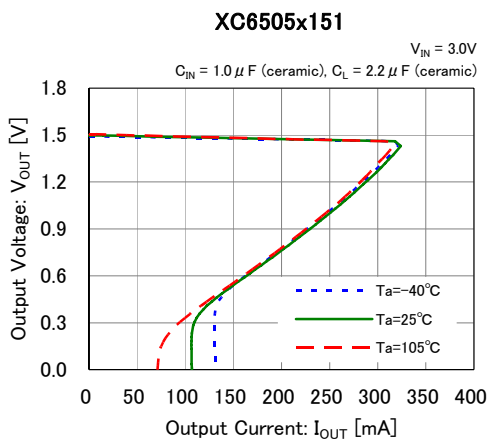

## TYPICAL PERFORMANCE CHARACTERISTICS (Continued)

### (1) Output Voltage vs. Output Current

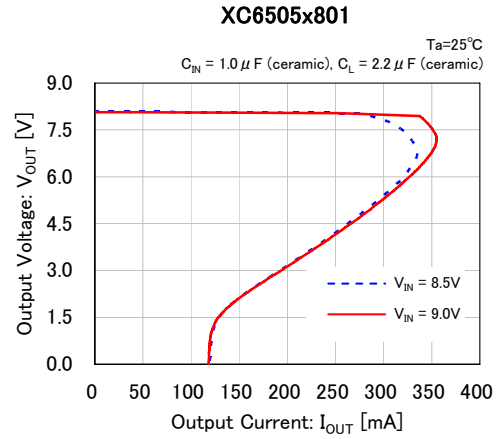
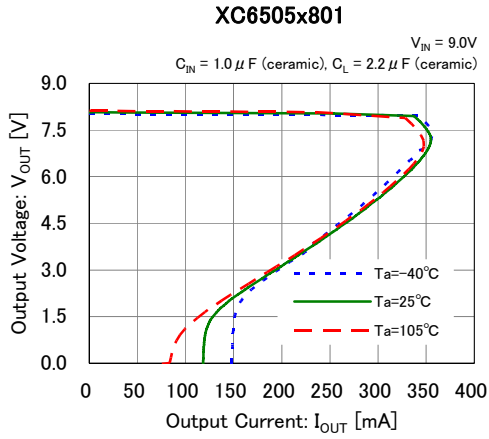

### (2) Output Voltage vs. Input Voltage

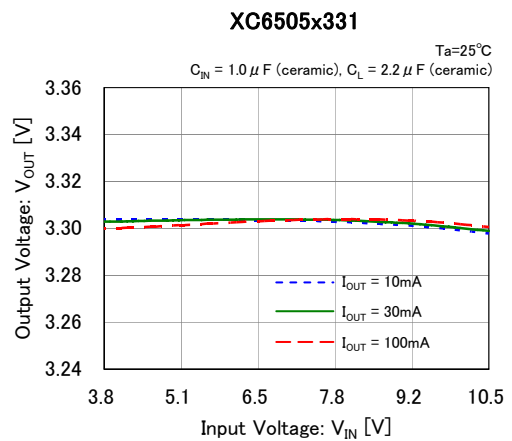
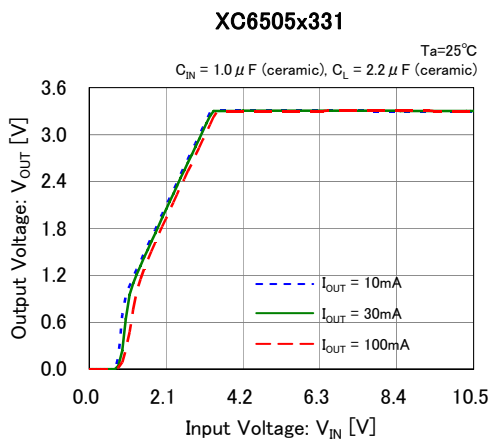
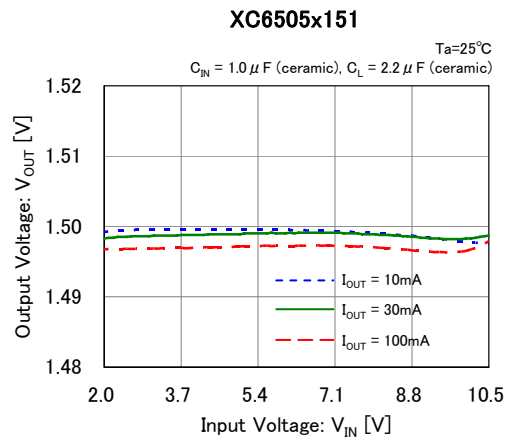
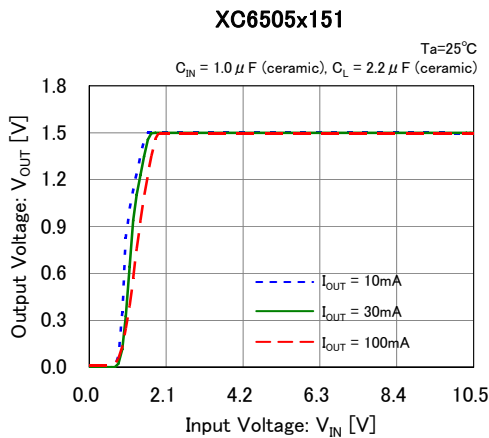

## ■ TYPICAL PERFORMANCE CHARACTERISTICS (Continued)

### (2) Output Voltage vs. Input Voltage

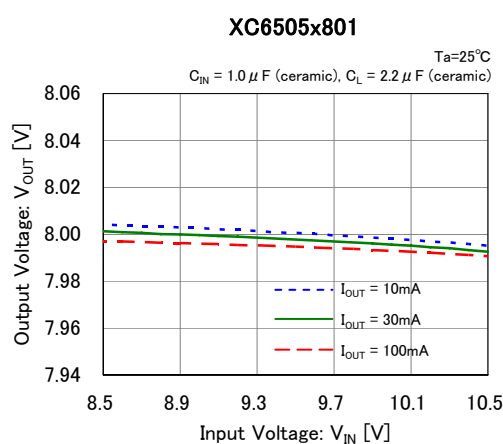
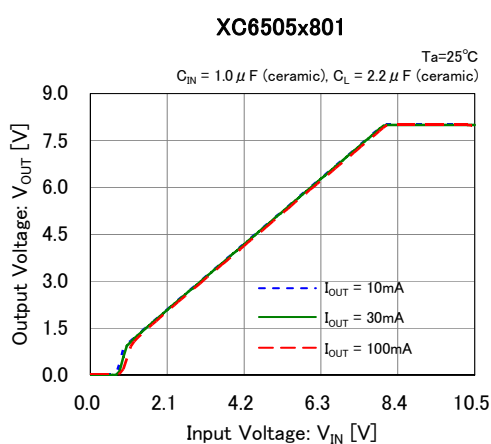
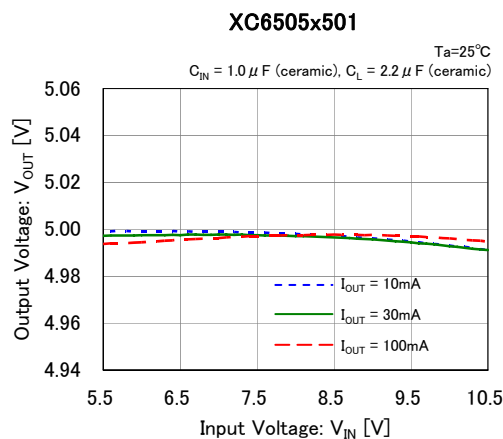
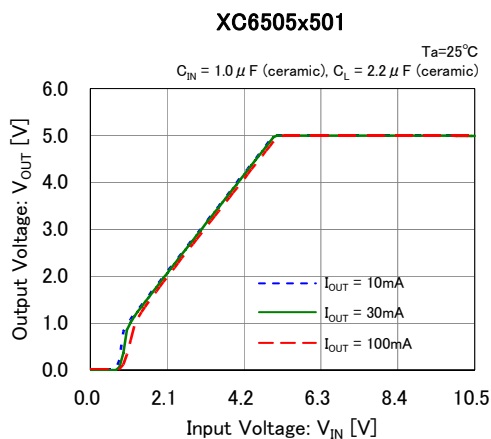

### (3) Dropout Voltage vs. Output Current

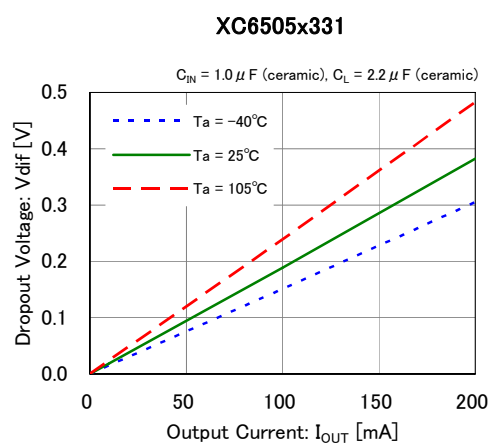
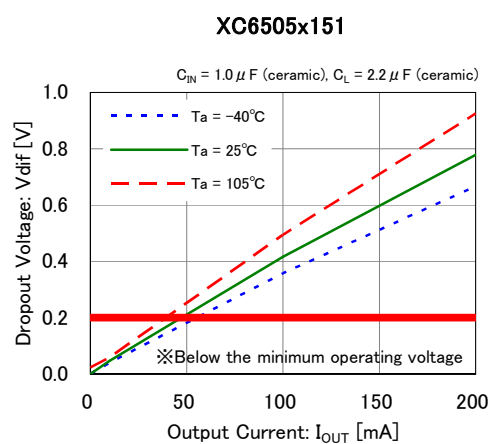

## TYPICAL PERFORMANCE CHARACTERISTICS (Continued)

### (3) Dropout Voltage vs. Output Current

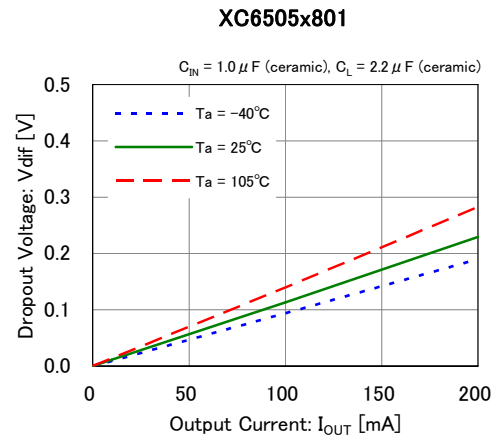
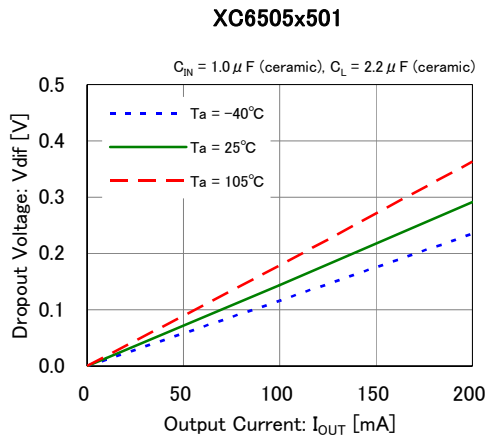

### (4) Supply Current vs. Input Voltage

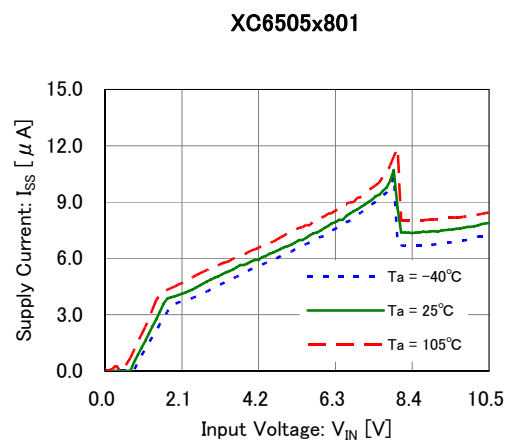
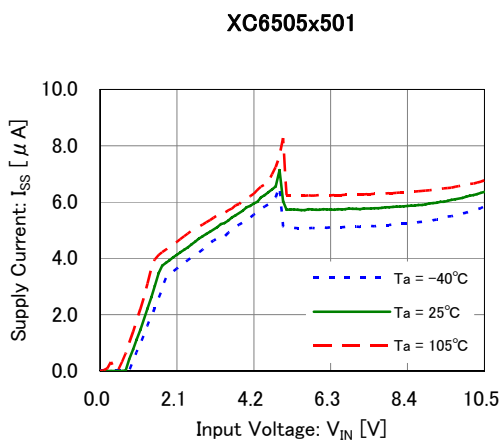
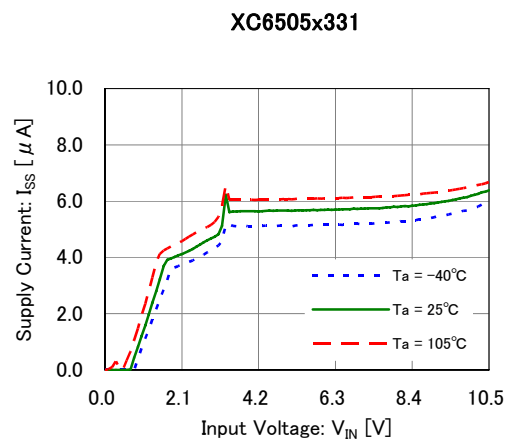
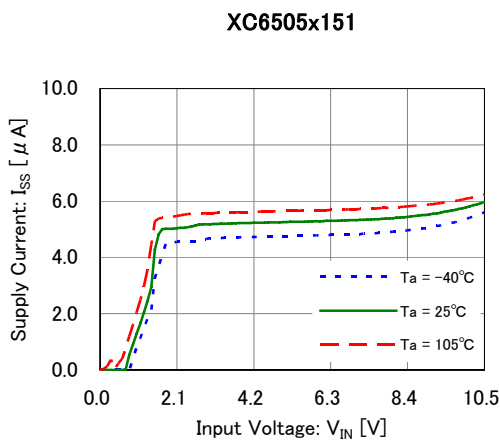

■ **TYPICAL PERFORMANCE CHARACTERISTICS (Continued)**

(5) Output Voltage vs. Ambient Temperature

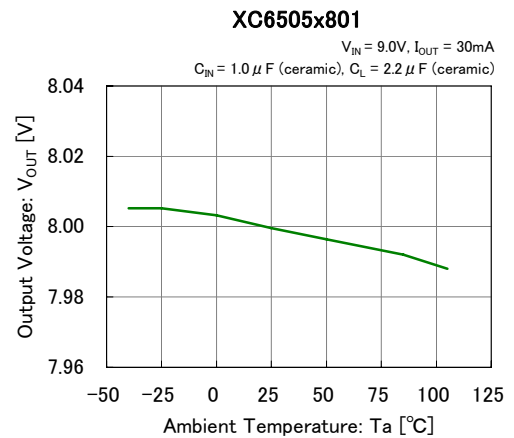
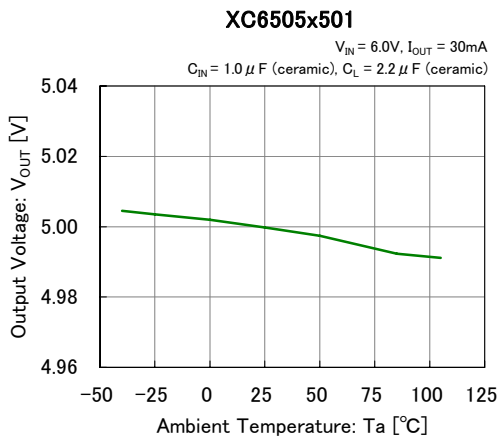
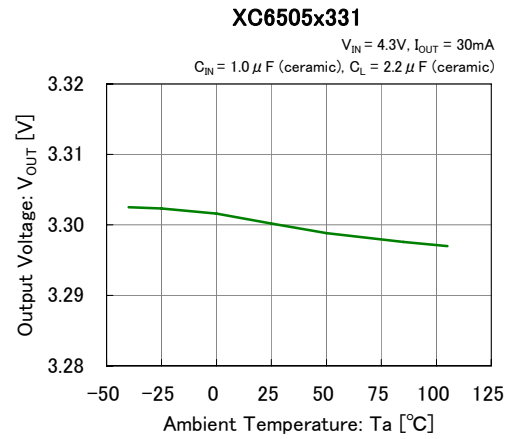
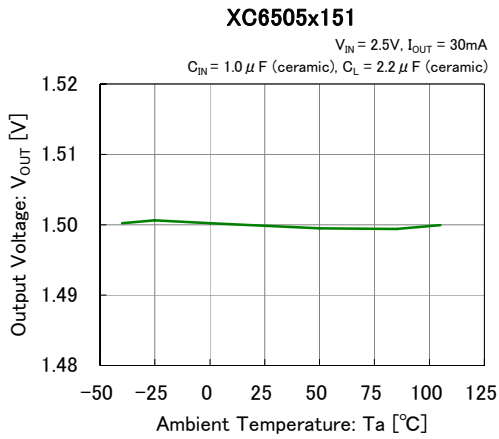

(6) Input Rising Response Time

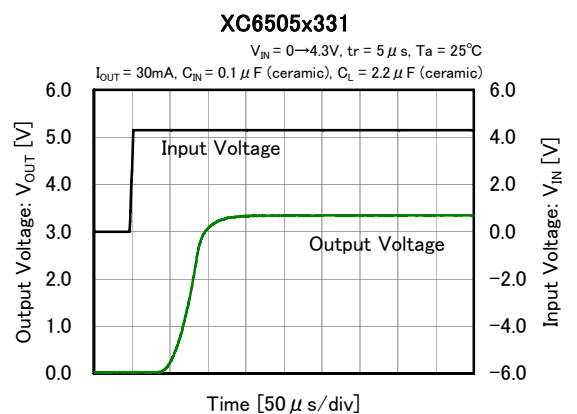
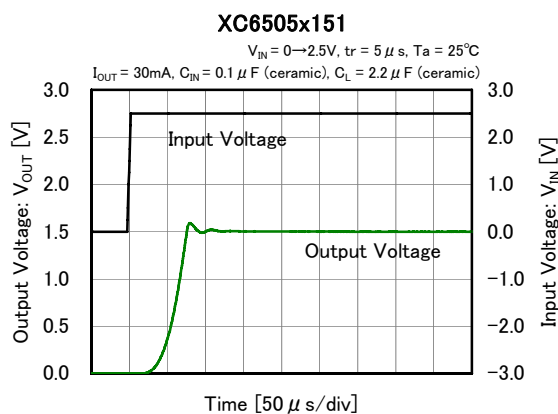

## TYPICAL PERFORMANCE CHARACTERISTICS (Continued)

### (6) Input Rising Response Time

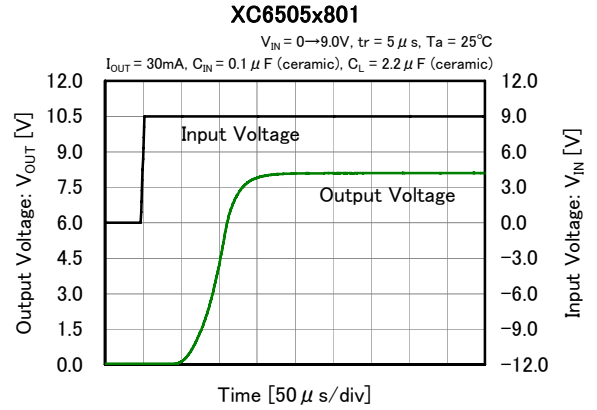
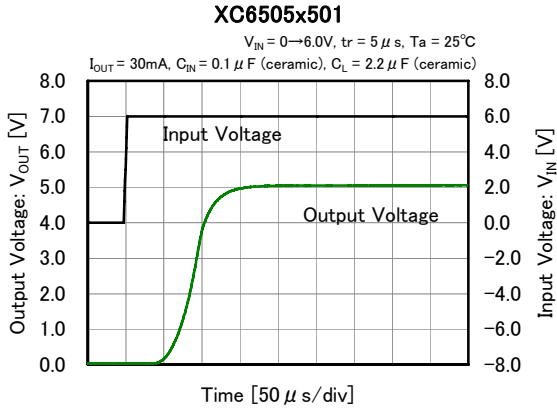

### (7) CE Rising Response Time

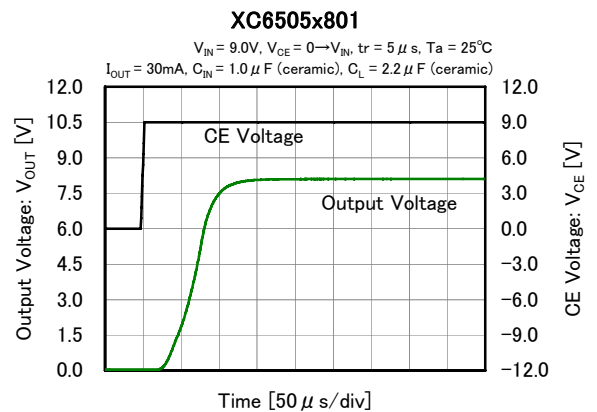
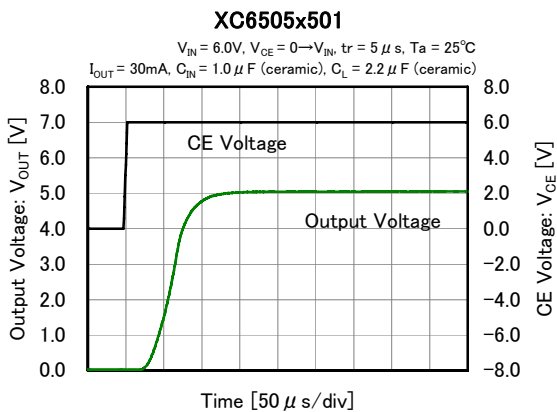
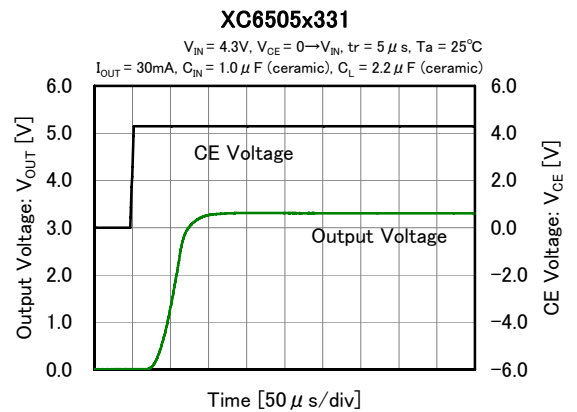
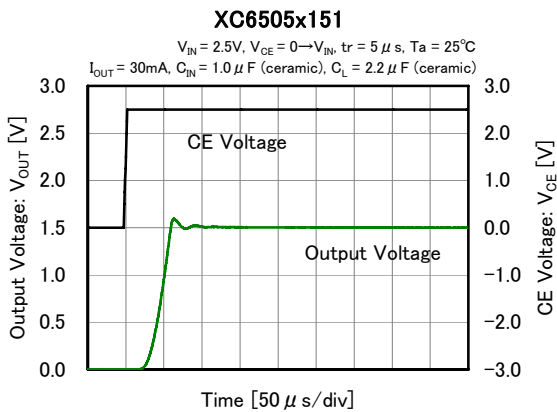

## ■ TYPICAL PERFORMANCE CHARACTERISTICS (Continued)

### (8) Rush Current

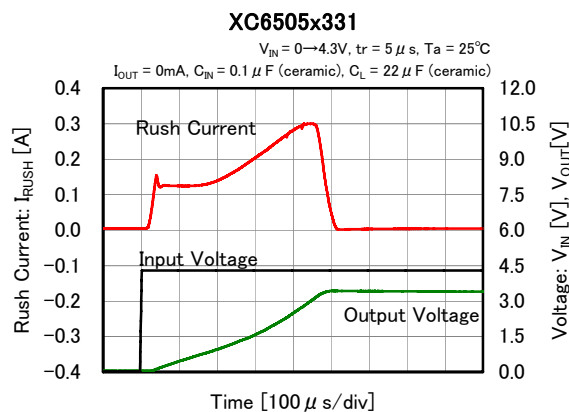
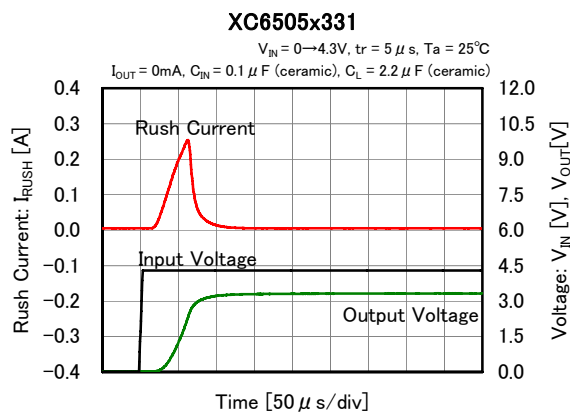

### (9) Input Transient Response

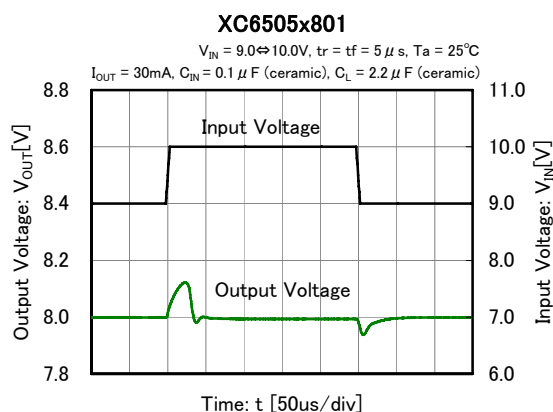
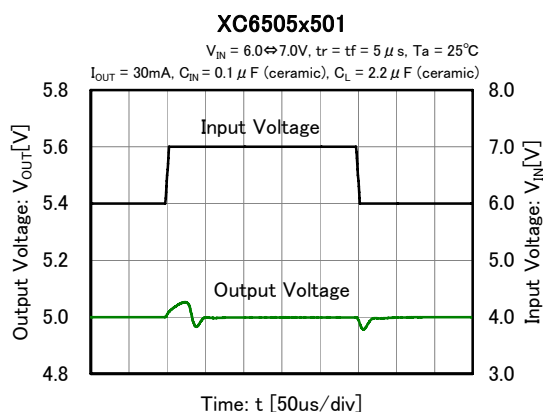
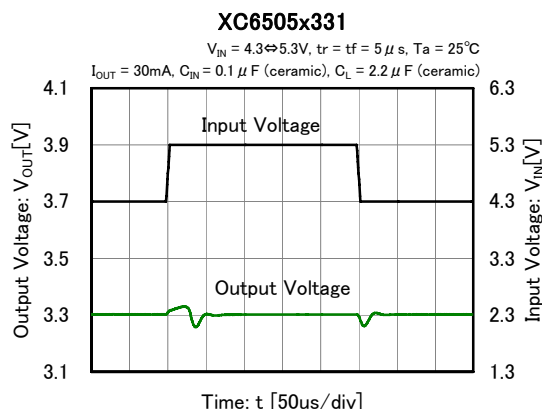
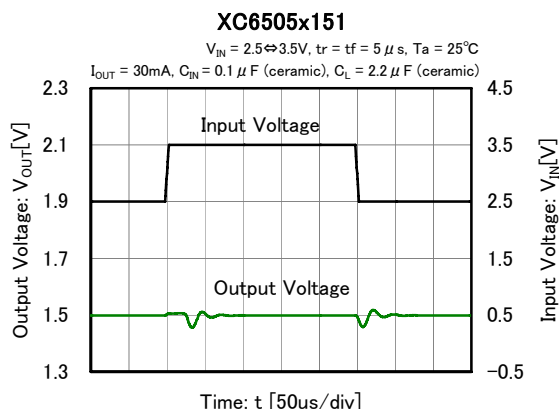

## TYPICAL PERFORMANCE CHARACTERISTICS (Continued)

### (10) Load Transient Response

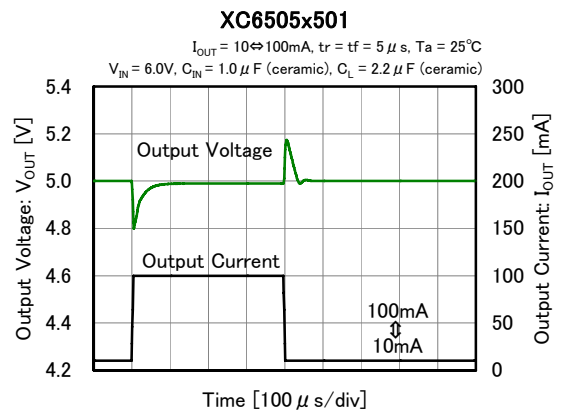
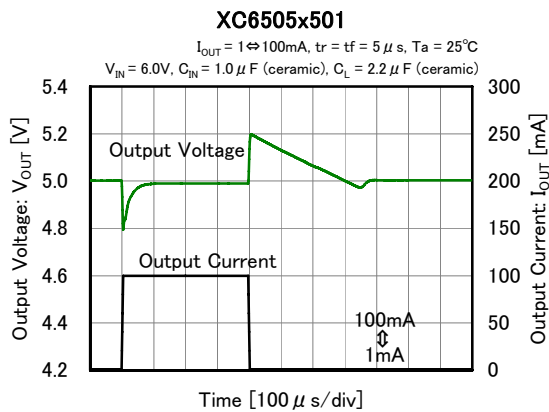
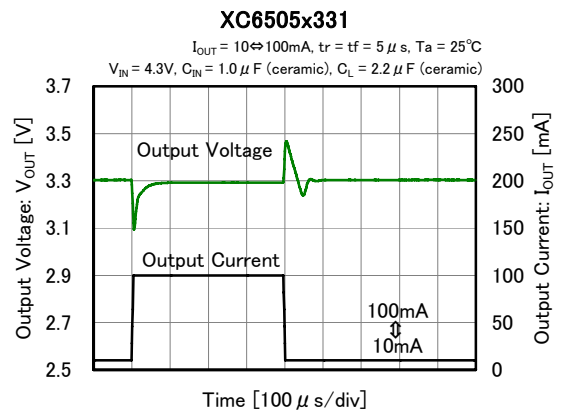
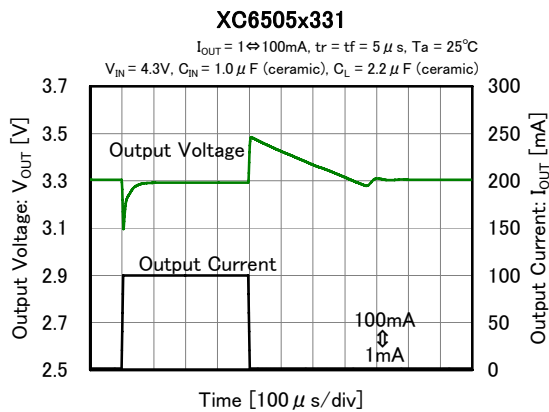
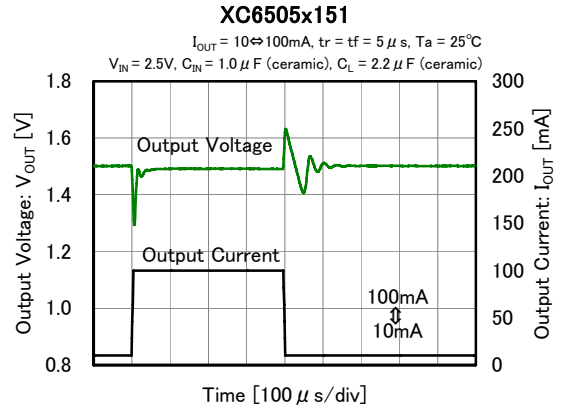
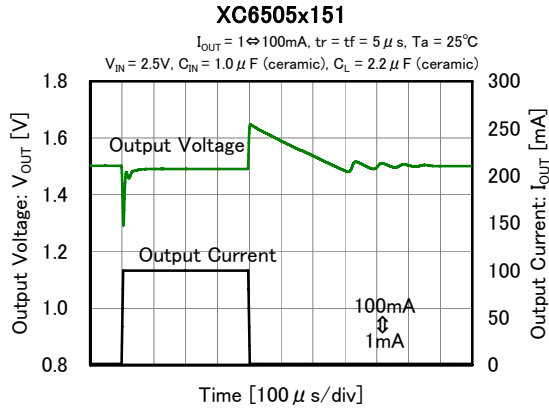



## ■ TYPICAL PERFORMANCE CHARACTERISTICS (Continued)

### (10) Load Transient Response

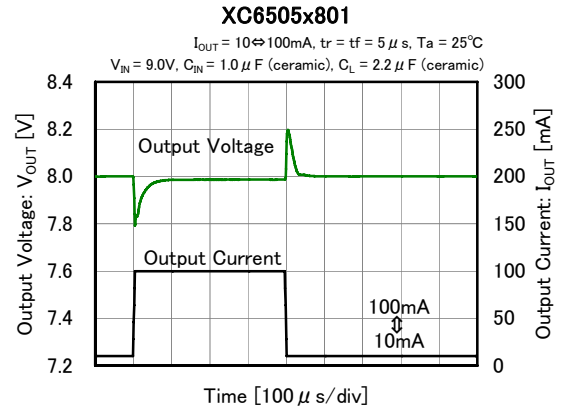
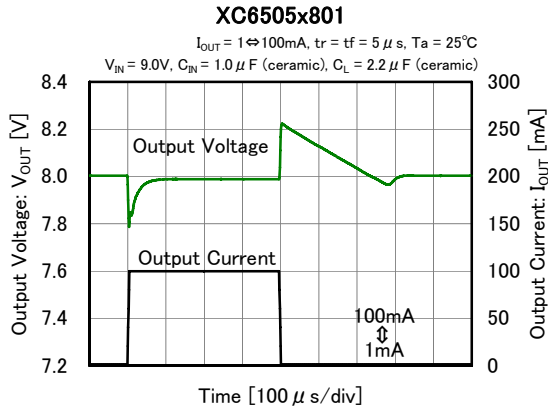

### (11) Ripple Rejection Rate

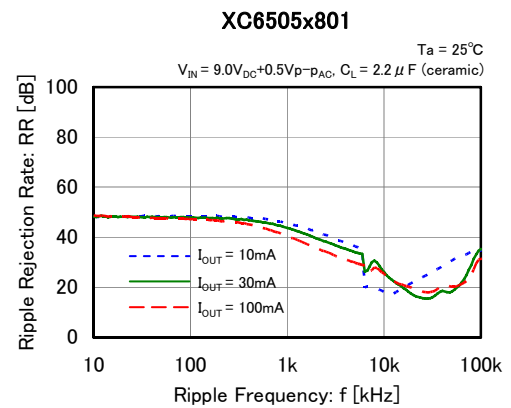
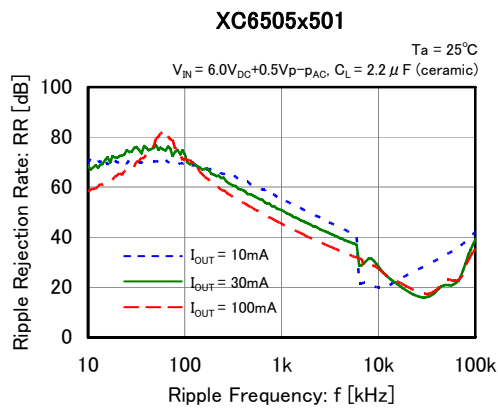
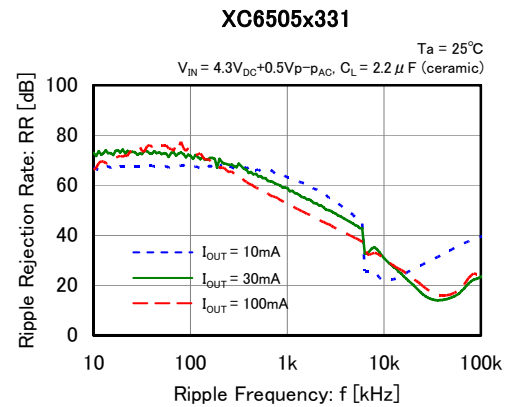
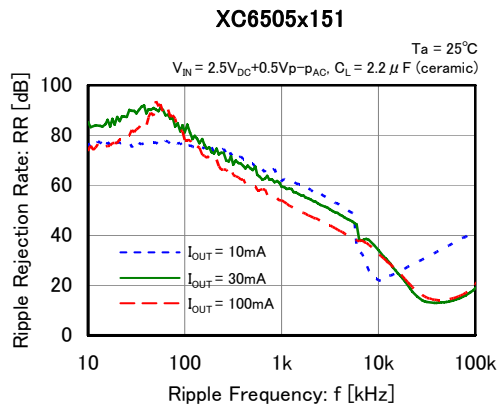

## PACKAGING INFORMATION

### ● USP-6C

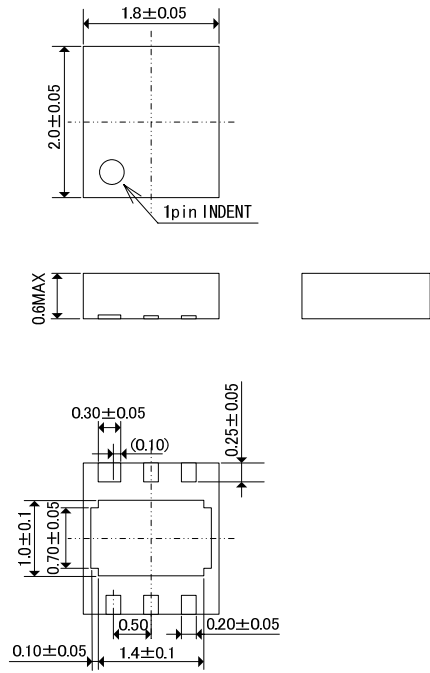

### ● SOT-25

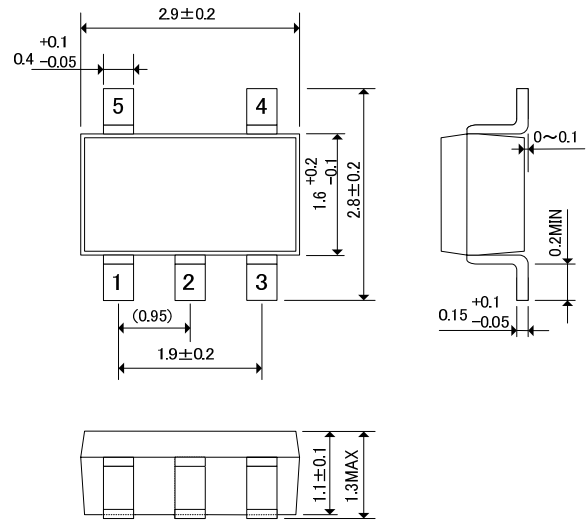

### ● SOT-89-5

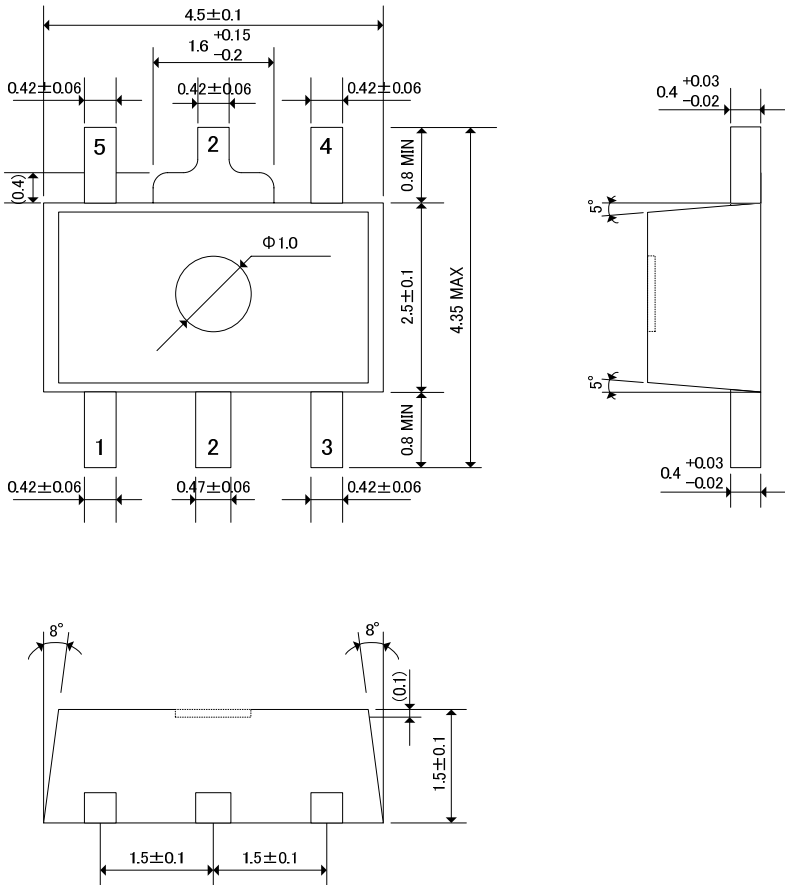

**PACKAGING INFORMATION (Continued)**

● USP-6C Reference Pattern Layout

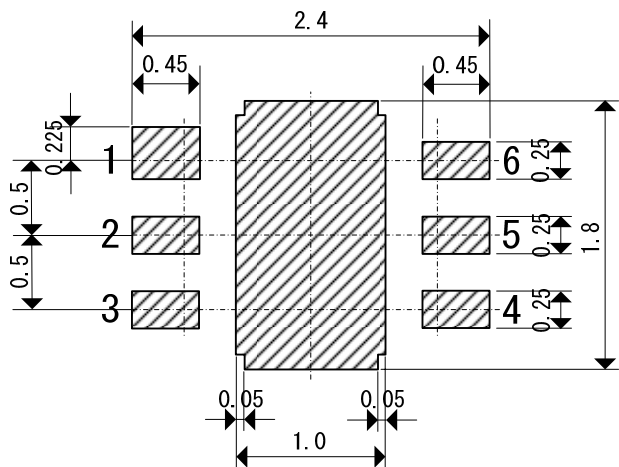

● USP-6C Reference Metal Mask Design

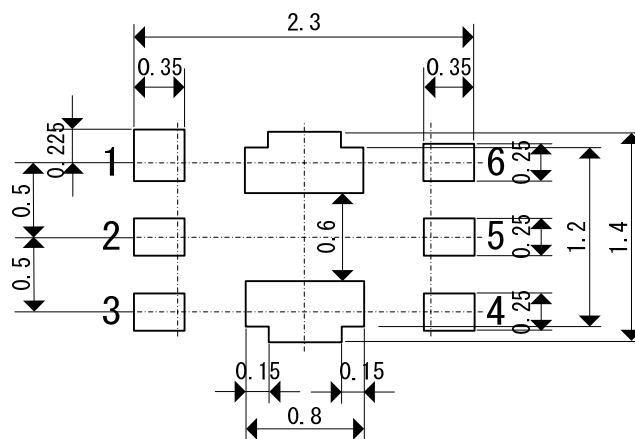

## PACKAGING INFORMATION (Continued)

### ● USP-6C Power Dissipation

Power dissipation data for the USP-6C is shown in this page.

The value of power dissipation varies with the mount board conditions.

Please use this data as one of reference data taken in the described condition.

#### 1. Measurement Condition (Reference data)

- Condition: Mount on a board
- Ambient: Natural convection
- Soldering: Lead (Pb) free
- Board: Dimensions 40 x 40 mm (1600 mm<sup>2</sup> in one side)  
Copper (Cu) traces occupy 50% of the board area  
In top and back faces  
Package heat-sink is tied to the copper traces
- Material: Glass Epoxy (FR-4)
- Thickness: 1.6 mm
- Through-hole: 4 x 0.8 Diameter

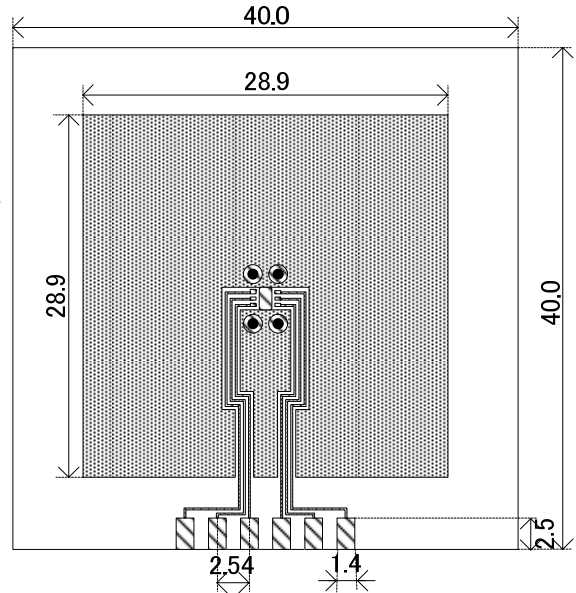

Evaluation Board (Unit: mm)

Board Mount ( $T_j \text{ max} = 125^\circ\text{C}$ )

Ambient Temperature ( $^\circ\text{C}$ )	Power Dissipation Pd (mW)	Thermal Resistance ( $^\circ\text{C}/\text{W}$ )
25	1000	100.00
105	200	

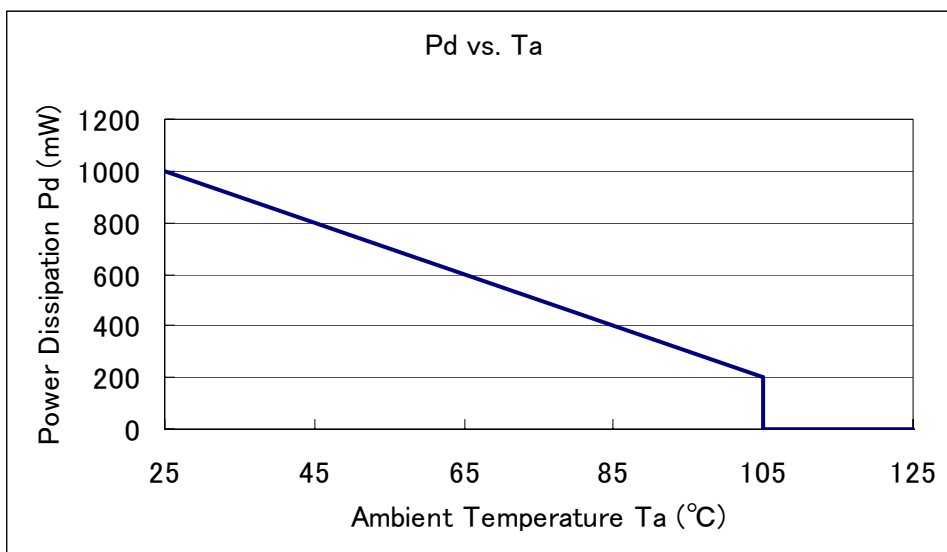

## ■ PACKAGING INFORMATION (Continued)

### ● SOT-25 Power Dissipation

Power dissipation data for the SOT-25 is shown in this page.  
The value of power dissipation varies with the mount board conditions.  
Please use this data as one of reference data taken in the described condition.

#### 1. Measurement Condition (Reference data)

- Condition: Mount on a board
- Ambient: Natural convection
- Soldering: Lead (Pb) free
- Board: Dimensions 40 x 40 mm (1600 mm<sup>2</sup> in one side)  
Copper (Cu) traces occupy 50% of the board area  
In top and back faces  
Package heat-sink is tied to the copper traces  
(Board of SOT-26 is used.)
- Material: Glass Epoxy (FR-4)
- Thickness: 1.6 mm
- Through-hole: 4 x 0.8 Diameter

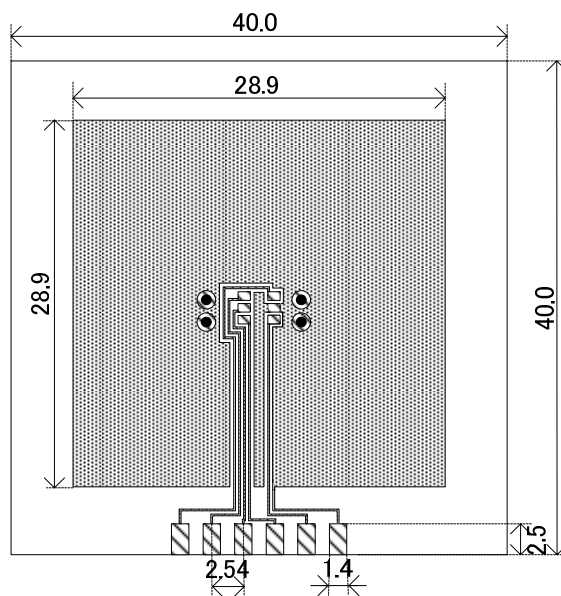

Evaluation Board (Unit: mm)

#### 2. Power Dissipation vs. Ambient Temperature

Board Mount ( $T_j \text{ max} = 125^\circ\text{C}$ )

Ambient Temperature ( $^\circ\text{C}$ )	Power Dissipation Pd (mW)	Thermal Resistance ( $^\circ\text{C}/\text{W}$ )
25	600	166.67
105	120	

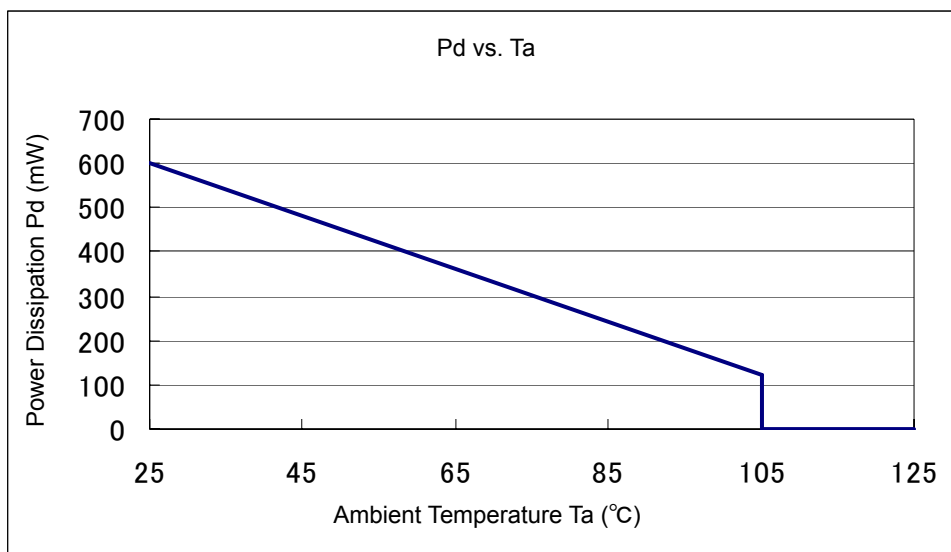

## PACKAGING INFORMATION (Continued)

### SOT-89-5 Power Dissipation

Power dissipation data for the SOT-89-5 is shown in this page.  
 The value of power dissipation varies with the mount board conditions.  
 Please use this data as one of reference data taken in the described condition.

#### 1. Measurement Condition (Reference data)

- Condition: Mount on a board
- Ambient: Natural convection
- Soldering: Lead (Pb) free
- Board: Dimensions 40 x 40 mm (1600 mm<sup>2</sup> in one side)  
 Copper (Cu) traces occupy 50% of the board area  
 In top and back faces  
 Package heat-sink is tied to the copper traces
- Material: Glass Epoxy (FR-4)
- Thickness: 1.6 mm
- Through-hole: 5 x 0.8 Diameter

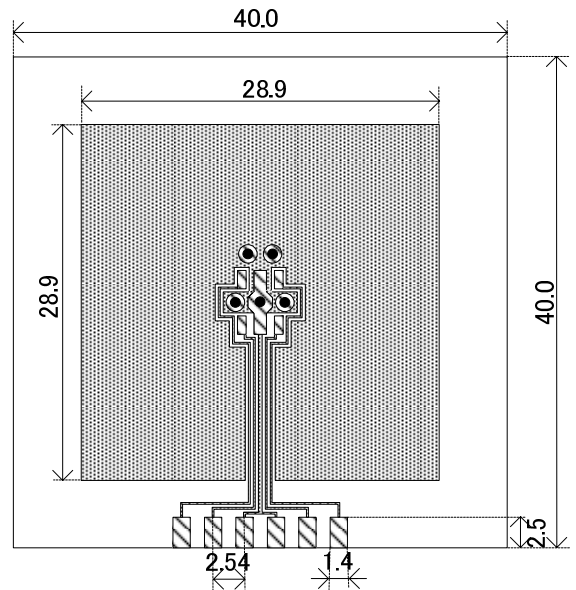

Evaluation Board (Unit: mm)

#### 2. Power Dissipation vs. Ambient Temperature

Board Mount ( $T_j \text{ max} = 125^\circ\text{C}$ )

Ambient Temperature ( $^\circ\text{C}$ )	Power Dissipation Pd (mW)	Thermal Resistance ( $^\circ\text{C}/\text{W}$ )
25	1300	76.92
105	260	

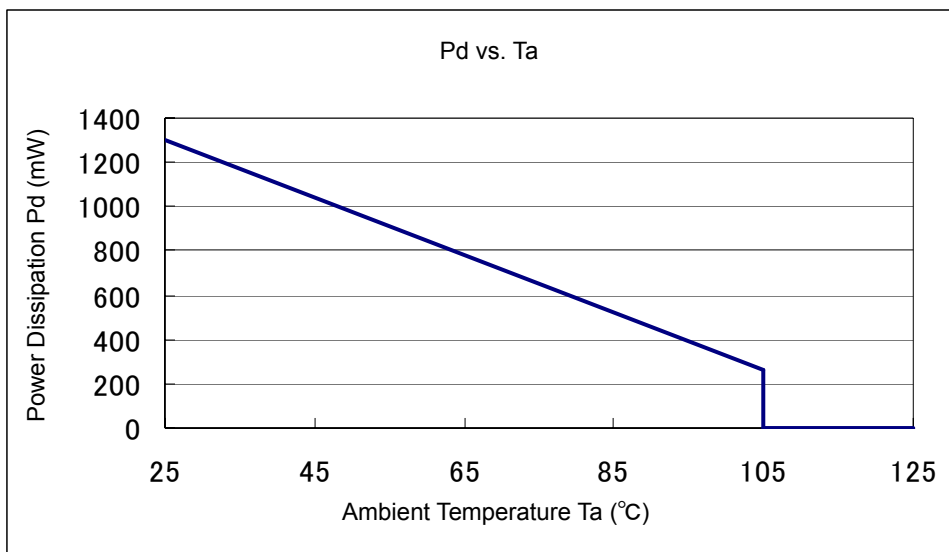

## MARKING RULE

● USP-6C

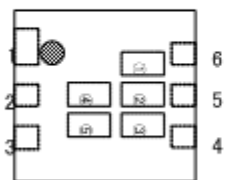

● SOT-25

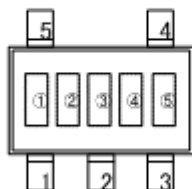

● SOT-89-5

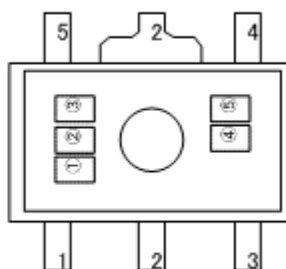

① represents product series

MARK	PACKAGE	PRODUCT SERIES
0	SOT-25/SOT-89-5	XC6505*****-G
3	USP-6C	XC6505*****-G

② represents type of regulator

	MARK				PRODUCT SERIES
	OUTPUT VOLTAGE =1.5~3.0V	OUTPUT VOLTAGE =3.1~5.0V	OUTPUT VOLTAGE =5.1~7.0V	OUTPUT VOLTAGE =7.1~8.0V	
TYPE OF REGULATOR "A"	0	1	2	3	XC6505A*****-G
TYPE OF REGULATOR "B"	4	5	6	7	XC6505B*****-G

③ represents output voltage

MARK	OUTPUT VOLTAGE (V)			MARK	OUTPUT VOLTAGE (V)		
0	-	3.10	6.10	F	1.60	4.60	7.60
1	-	3.20	6.20	H	1.70	4.70	7.70
2	-	3.30	6.30	K	1.80	4.80	7.80
3	-	3.40	6.40	L	1.90	4.90	7.90
4	-	3.50	6.50	M	2.00	5.00	8.00
5	-	3.60	6.60	N	2.10	5.10	-
6	-	3.70	6.70	P	2.20	5.20	-
7	-	3.80	6.80	R	2.30	5.30	-
8	-	3.90	6.90	S	2.40	5.40	-
9	-	4.00	7.00	T	2.50	5.50	-
A	-	4.10	7.10	U	2.60	5.60	-
B	-	4.20	7.20	V	2.70	5.70	-
C	-	4.30	7.30	X	2.80	5.80	-
D	-	4.40	7.40	Y	2.90	5.90	-
E	1.50	4.50	7.50	Z	3.00	6.00	-

④⑤ represents production lot number

01~09, 0A~0Z, 11~9Z, A1~A9, AA~AZ, B1~ZZ repeated.

(G, I, J, O, Q, W excluded)

\*No character inversion used.

1. The products and product specifications contained herein are subject to change without notice to improve performance characteristics. Consult us, or our representatives before use, to confirm that the information in this datasheet is up to date.
2. We assume no responsibility for any infringement of patents, patent rights, or other rights arising from the use of any information and circuitry in this datasheet.
3. Please ensure suitable shipping controls (including fail-safe designs and aging protection) are in force for equipment employing products listed in this datasheet.
4. The products in this datasheet are not developed, designed, or approved for use with such equipment whose failure or malfunction can be reasonably expected to directly endanger the life of, or cause significant injury to, the user.  
(e.g. Atomic energy; aerospace; transport; combustion and associated safety equipment thereof.)
5. Please use the products listed in this datasheet within the specified ranges.  
Should you wish to use the products under conditions exceeding the specifications, please consult us or our representatives.
6. We assume no responsibility for damage or loss due to abnormal use.
7. All rights reserved. No part of this datasheet may be copied or reproduced without the prior permission of TOREX SEMICONDUCTOR LTD.

**TOREX SEMICONDUCTOR LTD.**



单击下面可查看定价，库存，交付和生命周期等信息

[>>Torex Semiconductor\(特瑞仕\)](#)