



element14

EN - For pricing and availability in your local country please visit one of the below links:

DE - Informationen zu Preisen und Verfügbarkeit in Ihrem Land erhalten Sie über die unten aufgeführten Links:

FR - Pour connaître les tarifs et la disponibilité dans votre pays, cliquez sur l'un des liens suivants:

[CAN4311129200431K](#)

EN
This Datasheet is presented by
the manufacturer

DE
Dieses Datenblatt wird vom
Hersteller bereitgestellt

FR
Cette fiche technique est
présentée par le fabricant

Yageo High Frequency Products Selection Guide



Outline

1. Yageo HF solutions overview

2. Yageo HF Products

- 2.1. Ceramic Chip Antenna**
- 2.2. Ceramic Bulk Antenna**
- 2.3. Active GPS Antenna**
- 2.4. Metal Antenna**
- 2.5. LTCC Filter and Balun**
- 2.6. Ordering Code Information**
- 2.7. Antenna Application & End Product**
- 2.8. LTCC Filter and Balun Application & End Product**

3. Antenna Application Note

- 3.1. Ceramic Chip Antenna Design Guide**
 - 3.1.1 Regarding to Layout Issue**
 - 3.1.2 Select Chip Antenna to Tune**
 - 3.1.3 Chip Antenna Design Procedure**
- 3.2. Bulk Antenna**
 - 3.2.1 Antenna note**
 - 3.2.2 Bulk Antenna Design Procedure**
- 3.3 Metal Antenna**
 - 3.3.1 Metal Antenna Design Procedure**

4. LTCC Filter and Balun

- 4.1 Dual Band RF System Block**
- 4.2 Filter and Balun Function**

5. High Frequency Cross References

6. Appendix 1: Antenna Characteristic

7. Appendix 2: Designer Sample Kit

1. Yageo HF Solutions Overview

- From RF (Radio Frequency) system block, we develop antenna, LTCC filter and balun.

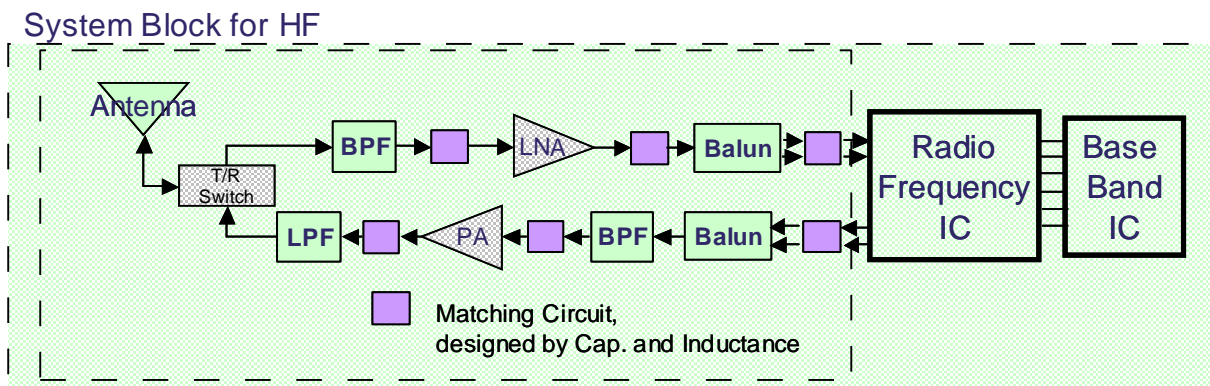

Antenna

- Ceramic
 - Chip / Bulk
- Active GPs
- Metal



LTCC Filter & Balun

- BPF
- LPF
- Diplexer
- Balun
- Combo



2. Yageo HF Product

1. Ceramic Chip Antenna
2. Ceramic Bulk Antenna
3. Active GPS Antenna
4. Metal Antenna
5. LTCC Filter and Balun

2.1 Ceramic Chip Antenna

Features

1. Embed antenna
2. Miniature
3. Surface mount device
4. Design pattern inside
5. Omni directional radiation
6. Non-ground surrounding antenna
7. Multi types for tuning



Product overview

Application	Frequency	Dimensions (mm)	Yageo Part No.	Note	
UHF	433 MHz	37.5x6.8x0.9	CAN4313121200431B	3 Types	
			CAN4313121200461B		
			CAN4313121200491B		
		4x12x1.5	CAN4311129200431K	1 Type	
TDMA	870 MHz	16.5x14x0.9	CAN4313119000871B	1 Type	
			12.1x4.1x1.6	CAN4311129070871K	3 Types
				CAN4311129080871K	
			CAN4311129090871K		
EGSM/DCS	900/1800 GHz	21x12x0.9	CAN4313118009181B	1 Type	
		12x4.4x1.2	CAN4311116009181K	1 Type	
DECT/WCDMA	1.88/2 GHz	8.8x6.8x0.9	CAN4311112001881K	1 Type	
Bluetooth /WLAN 802.11b/g	2.45 GHz	7.3x5.5x1.3	CAN4311111002451K	5 Types	
			CAN4311111002601K		
			CAN4311111002701K		
			CAN4311111002801K		
			CAN4311111002901K		
		7.8x3.6x1.3	CAN4311115002301K	5 Types	
			CAN4311115002451K		
			CAN4311115002601K		
			CAN4311115002701K		
		5.3x2.0x1.3	CAN4311153002001K	7 Types	
			CAN4311153002101K		
			CAN4311153002201K		
			CAN4311153002301K		
			CAN4311153002401K		
			CAN4311153002451K		
			CAN4311153002501K		
		3.2x1.6x1.2	CAN4311712002453K	9 Types	
			CAN4311712022453K		
			CAN4311712032453K		
			CAN4311712042453K		
			CAN4311712052453K		
			CAN4311712062453K		
			CAN4311712072453K		
			CAN4311712082453K		
			CAN4311712092453K		
		2.0x1.2x1.1	CAN4311714002454K	1 Type	
		GPS (linear polarization)	1.575 GHz	6.15x3.0x1.45	CAN4311113011582K
CAN4311113021582K					
CAN4311113031582K					

2.2 Ceramic Bulk Antenna

Features

1. Embedded antenna
2. Miniature
3. Surface mount device
4. High direction radiation
5. Ground plane under antenna
6. All products are applied for GPS application
7. Could be customization

SMD Type



Right Hand

Circular Polarization

Pin Type (Pin Feed Input)



Right Hand

Circular Polarization



Linear polarization

Product overview

Application	Frequency	Dimensions (mm)	Yageo Part No.	Note
GPS (linear polarization)	1.575 GHz	10*4.0*4.0	CAN4311231021581K	
GPS (Circular polarization)	1.575 GHz	12*12*4.0	CAN4313422011581B	SMD Type
		12*12*4.0	CAN4313423021581B	PIN Type
		12*12*4.0	CAN4313422031581B	PIN Type
		12*12*2.0	CAN4313422021581B	PIN Type
		15*15*4.0	CAN4313423011581B	SMD Type
		15*15*4.0	CAN4313423031581B	PIN Type
		15*15*4.0	CAN4313423041581B	PIN Type
		18*18*4.0	CAN4313424061581B	SMD Type
		18*18*4.0	CAN4313424161581B	SMD Type
		18*18*2.0	CAN4313424021581B	PIN Type
		18*18*4.0	CAN4313424031581B	PIN Type
		18*18*4.0	CAN4313424041581B	PIN Type
		18*18*2.0	CAN4313424051581B	PIN Type
		25*25*2.0	CAN4313425021581B	PIN Type
25*25*4.0	CAN4313425031581B	PIN Type		

2.3 Active antenna

Features

1. Embedded antenna
2. Miniature
3. High direction radiation
4. Intergrate GPS antenna with LNA (Low noise amplifier)
6. Connector, brand used such as I-Pex, Herose, MMCX, is available
7. Right hand circular polarization
4. LNA gain from 16~30dB depends on size
5. Supply voltage 3~3.3V
6. Could be customization

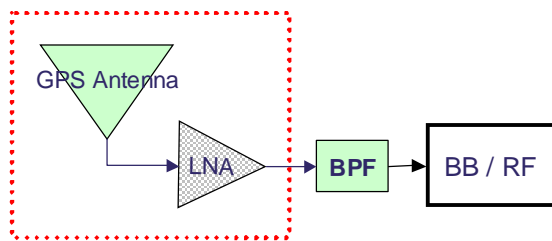

GPS Active Antenna



Product overview

Application	Frequency	Dimensions (mm)	Yageo Part No.
Active GPS (Circular polarization)	1.575 GHz	35*28*7.0	CAN4313438971581B
		35*28*7.0	CAN4313438981581B
		13*13*7.0	CAN4313434901581B
		13*13*5.5	CAN4313434881581B
		16*16*7.0	CAN4313435941581B
		16*16*7.0	CAN4313435921581B
		19*19*7.0	CAN4313437931581B
		19*19*5.0	CAN4313437951581B
		21*15*7.0	CAN4313435911581B
		21*15*7.0	CAN4313435951581B

2.4 Metal antenna overview

Feature

- Customization
- Embedded antenna
- Antenna with cable and connector
- I-Pex, Herose, MMCX connector is available
- Better performance on Gain and efficiency



Product overview

Applicaton	Frequency
WWAN	900M or 1.8G or 2.1G
GPS	1.575GHz
WLAN	2.4, 2.4/5GHz
BT	2.4GHz
UWB	3~5GHz
WiMax	2G ,3G , 5GHz

All metal antennas are customization. Dimension could be referred to below table but detail spec could be discussed with Yageo FAE.

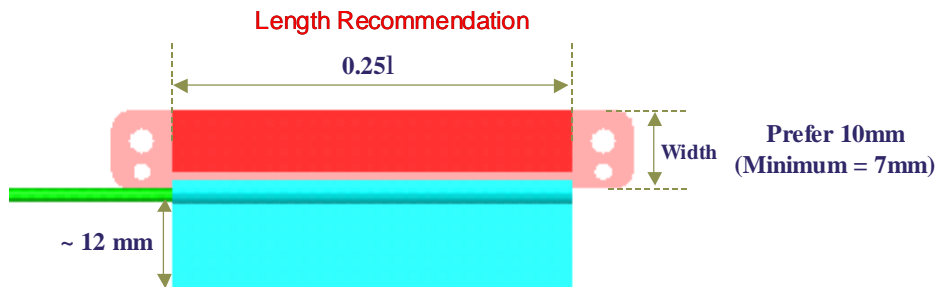

Application	Freq.	L (mm)	L/4 (mm)
GSM/PCS	900	333	83
GPS	1575	190	48
UMTS / CDMA	2100	143	36
WLAN(11a/b/g) / BT	2400	125	31
UWB	3100	97	24
WiMax 23	2300	130	33
WLAN (11a)	4900	61	15

2.5 Filter and Balun

Features

- LTCC Process
- Miniature
- High Q, low loss
- 3D design, integrate passives

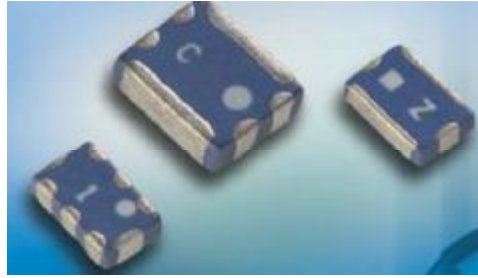

Product overview

Band Pass Filter

Part no.	Frequency (MHz)	Dimension(mm)			Insertion Loss (dB)Max	Attenuation (dB) min	Cross ref . Specs
		L	W	T			
CFL4111713022453K	2400-2500	2.5	2.0	0.95	2.5	30dB@2.1GHz, 30dB@4.8-5GHz	Soshin MDR 742F Samsung LCB22B2450L1
CFL4111713032453K	2400-2500	2.5	2.0	0.95	1.5	30dB@1.85-1.91GHz, 20dB@4.8-5GHz	Soshin MDR746f ACX BF2520-B2R4CAC
CFL4111713052453K	2400-2500	2.5	2.0	1.10	1.5	20dB@1.85-1.91GHz, 30dB@4.8-5GHz	Samsung LCB22M2450B1
CFL4111713072453K	2400-2500	2.5	2.0	1.20	2.5	20dB@2.7GHz, 25dB@4.8-5GHz	Soshin MDR767f Murata LFB2H2G45SG7B734
CFL4111713182453K	2400-2500	2.5	2.0	0.95	2.2	30dB@1.6GHz ,35dB@3.2GHz	ACX BF2520-B2R4CAE
CFL4111714032454K	2400-2500	2.0	1.25	0.85	2.0	40dB@4.9GHz	Murata LFB212G45G8A127 SamsungBPF LCB21B2450Q1
CFL4111714052454K	2400-2500	2.0	1.25	0.90	2.0	24dB@3.2GHz , 30dB@4.8-5GHz	Soshin HMD843K
CFL4111714062454K	2400-2500	2.0	1.25	0.85	1.8	30dB@1.71-1.91GHz, 25dB@4.8-5GHz	Soshin HMD846H Murata LFB212G45SG8A166
CFL4111714182454K	2400-2500	2.0	1.25	1.10	2.2	30dB@1.6GHz ,35dB@3.2GHz	
CFL4111714015004K	4900-5950	2.0	1.25	1.0	1.5	30dB@1.28~3GHz, 25dB@3.3~4GHz 25dB@9.8~11.9GHz	Murata LFB215G37SG8A180 ACX BF2012-B5R5DAC
CFL4111714035004K	4900-5900	2.0	1.25	0.85	2.2	25dB@6.85~7.15GHz, 20dB@7.5~9GHz	Murata LFB215g37SG8A185
CFL4111714055004K	5150-5850	2.0	1.25	0.90	1.8	20dB @4.7GHz	Soshin HMD861H

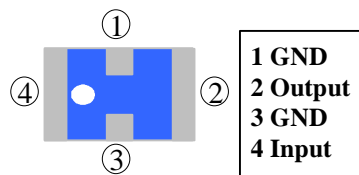
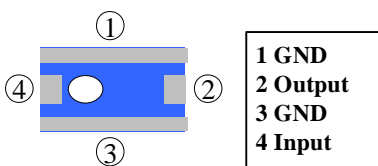

CFL4111713022453K CFL4111714015004K
 CFL4111713032453K CFL4111714035004K
 CFL4111713052453K CFL4111714055004K
 CFL4111713072453K
 CFL4111713182453K
 CFL4111714032454K
 CFL4111714052454K

CFL4111714062454K
 CFL4111714182454K

P.S Marker shape depend on data sheet

Low Pass Filter

Part no.	Frequency (MHz)	Dimension(mm)			Insertion Loss (dB)Max	Attenuation (dB) min	Cross ref. Specs
		L	W	T			
CFL4111714502454K	2400-2500	2.0	1.25	0.85	0.5	27dB@5GHz, 25dB@7.5GHz	ACX LF2012-B2R4FAB
CFL4111715502454K	2400-2500	1.6	0.8	0.65	0.45	25dB@5GHz, 18dB@7.5GHz	Toko LPFLTF1608L-F2R4L
CFL4111715503504K	3000-4000	2.0	1.25	0.85	0.50	35dB@6.8GHz, 30dB(ref)@11GHz	

Port Configurations

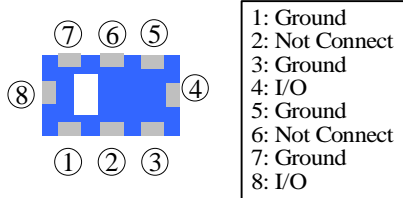

CFL4111714502454K

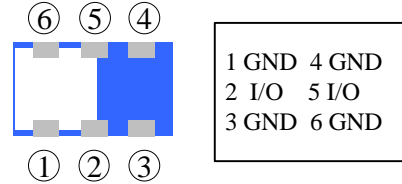

CFL4111715502454K

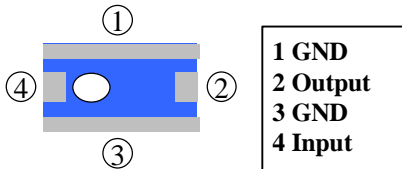

CFL4111714502454K

P.S Marker shape depend on data sheet

Diplexer

Part no.	Frequency (MHz)	Insertion Loss (dB)Max	Attenuation (dB)min	Dimension(mm)			Cross ref. Specs
				L	W	T	
CFL4111714802504K	2400-2500	0.6	18dB @4.8-6GHz 20dB @7.2-7.5GHz	2.0	1.25	0.75	Soshin HMD888j NTK LDG0UQD-3060D
	4900-5900	1.1	18dB @1.8-2.5GHz 15dB @10.3-10.7GHz	2.0	1.25	0.75	
CFL4111714822504K	2400-2500	0.7	17dB @4.8-6GHz 20dB @7.2-7.5GHz	2.0	1.25	0.75	Soshin HMD881j
	4900-5900	1.6	17dB @1.8-2.5GHz 20dB @10.3-10.7GHz	2.0	1.25	0.75	
CFL4111714852504K	2400-2500	0.7	20dB @4.9-5.9GHz	2.0	1.25	0.85	NTK LDG0UQD-3051A Murata LFD212G45DP3A151
	4900-5900	0.9	20dB @2.4-2.5GHz	2.0	1.25	0.85	

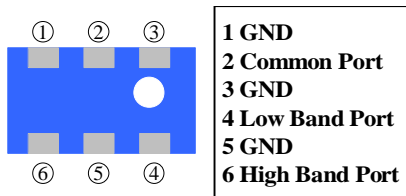

CFL4111714802454K

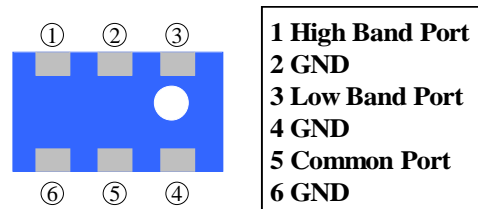

CFL4111714822454K

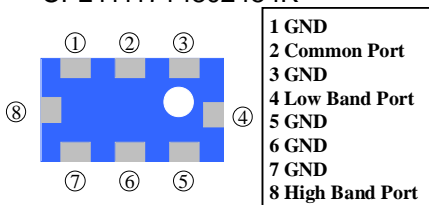

CFL4111714852454K

P.S Marker shape depend on data sheet

Balun

Part no.	Frequency (MHz)	Dimension(mm)			Unbalance Impedance	Balance Impedance	Insertion Loss (dB)Max	Amplitude difference (dB) max	Phase difference (Deg)	Cross ref . Specs
		L	W	T						
CBA4711714002454K	2400-2500	2.0	1.25	0.80	50	50	1.0	2.0	180 +/- 10	TDK HHM15-series Murata LDB212G45_
CBA4711714012454K	2400-2500	2.0	1.25	0.80	50	100	1.0	2.0	180 +/- 10	
CBA4711714022454K	2400-2500	2.0	1.25	0.80	50	200	1.0	2.0	180 +/- 10	
CBA4711715002454K	2400-2500	1.6	0.80	0.65	50	50	1.2	1.0	180 +/- 10	TDK HHM1710D1
CBA4711714015004K	4900-5900	2.0	1.25	0.80	50	100	1.2	2.0	180 +/- 10	TDK HHM1562B Murata LDB215G5110C001
CBA4711715015004K	4900-5950	1.6	0.80	0.65	50	100	1.2	1.5	180 +/- 10	Panasonic EHF4B5250

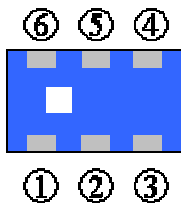

1:Unbal. Port
2: Ground or DC
3:Balanced Port
4: Balanced Port
5: Ground
6: Not Connect

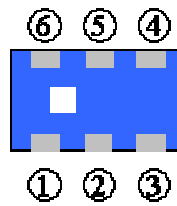

1:Unbal. Port
2: Ground
3:Balanced Port
4: Balanced Port
5: Ground
6: Not Connect

CBA4711714002454k

CBA4711714012454k

CBA4711714022454k

CBA4711714015004k

CBA4711715002454K

CBA4711715015004K

P.S Marker shape depend on data sheet

Balun Filter = Combo

Part no.	Frequency (MHz)	Dimension(mm)			Impedance		Insertion Loss (dB)Max	Difference		Attenuation (dB)min	Cross ref . Specs
		L	W	T	Unbal.	Balance		Amplitude (dB) max	Phase (Deg)		
CBA4711714672454K	2400-2500	2.0	1.25	0.90	50	Conjugate CSR BC04	3.0	1.0	180 +/- 5	25dB @1.3~1.6GHz 30dB @4.8~5GHz 25dB @7.2~7.5GHz	Soshin DBF81F106
CBA4711714982454K	2400-2500	2.0	1.25	0.90	50	Conjugate CSR BC03/04	3.0	1.0	180 +/- 5	25dB @1.3~1.6GHz 35dB @4.8~5GHz 30dB @7.2~7.5GHz	Soshin DBF81F106
CBA4711713912453K	2400-2500	2.5	2.0	1.2	50	50	2.0	1.0	180 +/- 08	22dB @1.71-1.91GHz 20dB @5GHz, 30dB @7.5GHz	Soshin DBF 70A001
CBA4711713932453K	2400-2500	2.5	2.0	1.1	50	Conjugate CSR BC02/03	3.0	1.0	180 +/- 5	20dB @2.11~2.17GHz 20dB @4.8~5GHz, 20dB @7.2~7.5GHz	Soshin DBF71B101

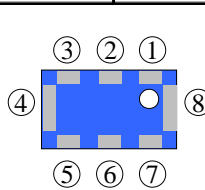

1:NC
2:Unbalanced Port
3:NC
4:GND
5:Balanced Port
6:NC
7:Balanced Port
8:GND

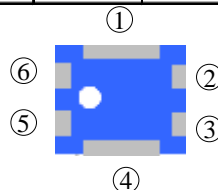

1 GND
2 Balanced Port
3 Balanced Port
4 GND
5 GND / DC
6 Unbal Port

CBA4711713912453K

CBA4711713932453K

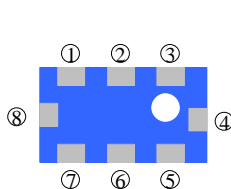

1 GND
2 Common Port
3 GND
4 Low Band Port
5 GND
6 GND
7 GND
8 High Band Port

CBA4711714672454K

CBA4711714982454K

2.6 Ordering Code Information

ORDERING INFORMATION: 12NC Ordering Code

These code numbers can be determined by the following rules:

CAN43 11 7 12 00 245 3K
F C MS T A P

F. Family Code

CAN**43** = Antenna

CFL**41** = Filter/ Diplexer

CBA**47** = Balun/ Combo

C. Packing Type Code

11 = Tape, 180mm/ 7" reel

13 = Bulk

M. Materials Code

7 = High Frequency Material

S. Size Code (CFL **41** for example)

11 = 3.2 * 2.5 mm

12 = 3.2 * 1.6 mm

13 = 2.5 * 2.0 mm

14 = 2.0 * 1.25 mm

15 = 1.6 * 0.8 mm

T. Type

00 = Type 00

A. Working Frequency

245 = 2.45 GHz

P. Packing Type Code

3K = 3000pcs taping

2.7 Antenna Application & End product

		Application / Frequency								
		UHF	GSM/PCS	CDMA / UMTS	GPS	WLAN 802.11a/b/g	MIMO 802.11n	BT	UWB	WiMax 802.16
		4330MHz	900M/1.8G/1.9G	2.1G	1.575G	2.4G/5G	2.4/5G	2.4G	3.1-4.8G (BGI)	2G, 3G, 5G
End Product	Walk Talk	√								
	Cell phone		√	√		√		√		
	PDA		√	√	√	√		√		
	Laptoep		√		√	√	√	√	√	√
	Neavigation				√					
	Acess point		√			√	√		√	√
	Router					√	√			√
	Earphone							√		
	USB dongle					√		√	√	
	Card - Cardbus		√			√	√		√	√

2.8 LTCC Filter and Balun Application & End product

		Application / Frequency				
		WLAN 802.11a/b/g	MIMO 802.11n	BT	UWB	WiMax 802.16
		2.4G/5G	2.4/5G	2.4G	3.1-4.8G (BGI)	2G, 3G, 5G
Product	Cell phone	√		√		
	PDA	√		√		
	Acess point	√	√		√	√
	Router	√	√			√
	Earphone			√		
	PCI	√	√			√
	Card - PCMIC	√	√		√	√
	Card - PCI Express	√	√		√	√
	Card - Cardbus	√	√		√	√

3. Application Note

3.1 Ceramic Chip Design Guide

When designing the product, the designer needs to consider layout guide and choosing the proper chip antenna base on following design guide.

3.1.1 Regarding to layout issue

1. Antenna position

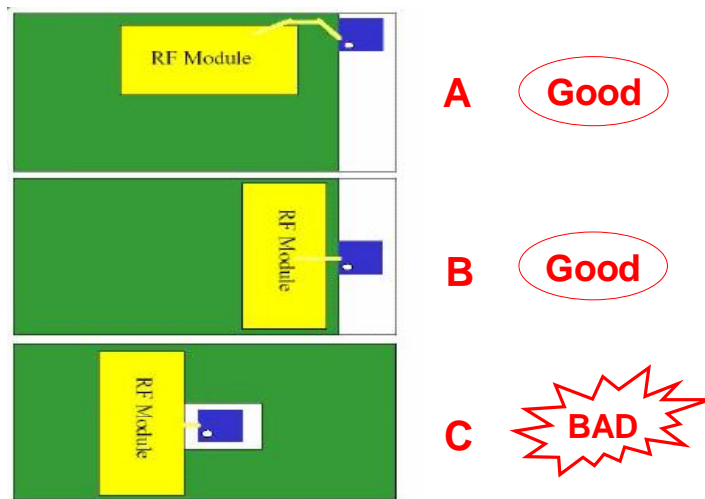

Antenna location arrangement for PCB

Position A and B are suitable for antenna to radiate property, however, position C is bad for antenna radiation.

2. PCB Ground layer arrangement

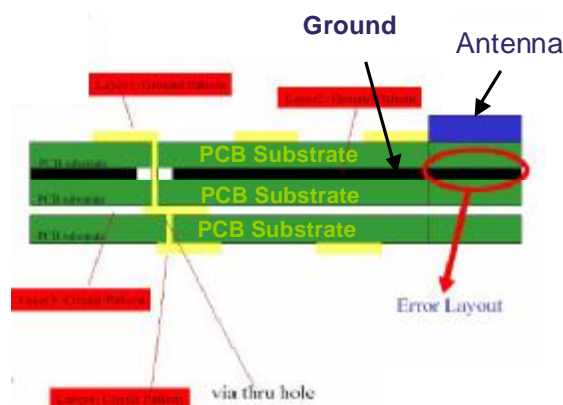

Ground layer

No ground layer is beneath antenna.

3. Distance between antenna and ground plane for BT and WALN antenna

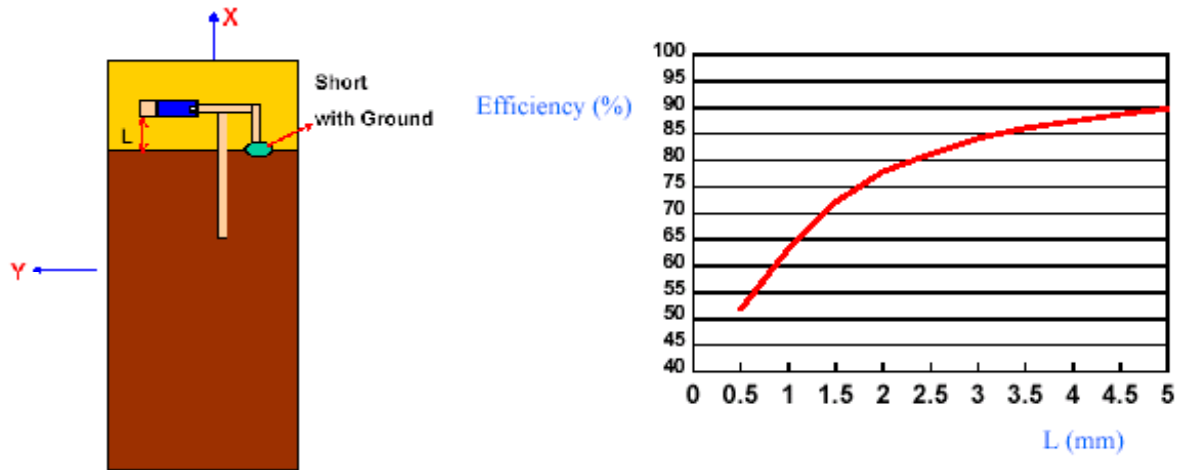

Distance vs. Efficiency

The efficiency is saturation when the distance between antenna and ground plane is over 5 mm. In General, 5 mm distance between chip antenna and ground plane is proper design.

4. Layout guide

Base on three considerations, it is proper to place chip antenna to the edge of the pub with no ground layer beneath the antenna and 5mm away from the ground plane as shown Figure. 9

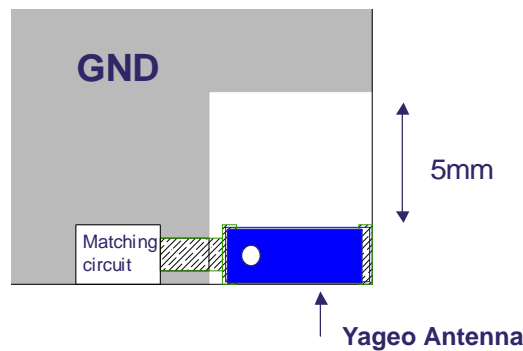

3.1.2 Select chip antenna to tune.

1. Base on size and center frequency

Sometimes antenna performance is affected by layout and mockup. In order to solve this issue, most of our chip ceramic has multi-types for tuning. Base on 5.3*2.0mm for 2.4G application, there are 7 types with different center frequency, And there are 5 types on 7.8*3.6mm size and 9 types on 3.2*1.6mm size.

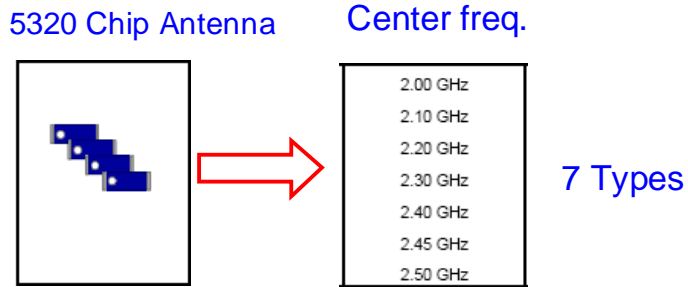

Example: 7 types of 5.3*2.0 mm antenna for 2.4G application

2. Matching issue

After selecting suitable type, tuning matching circuit could make better return loss. So matching circuit for antenna should be design when using ceramic antenna.

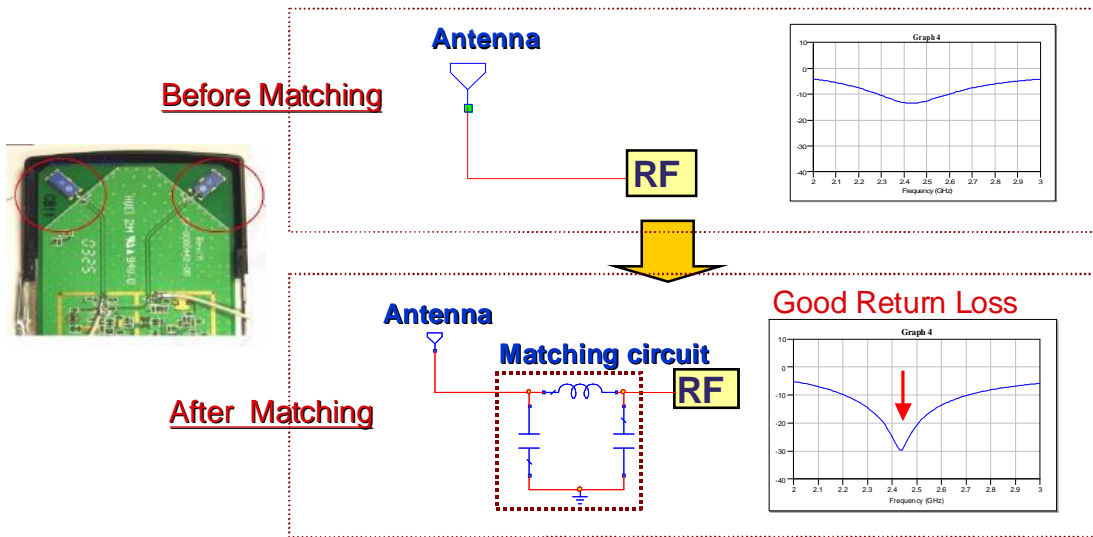

Matching circuit

3.1.3. Chip Antenna Design Procedure

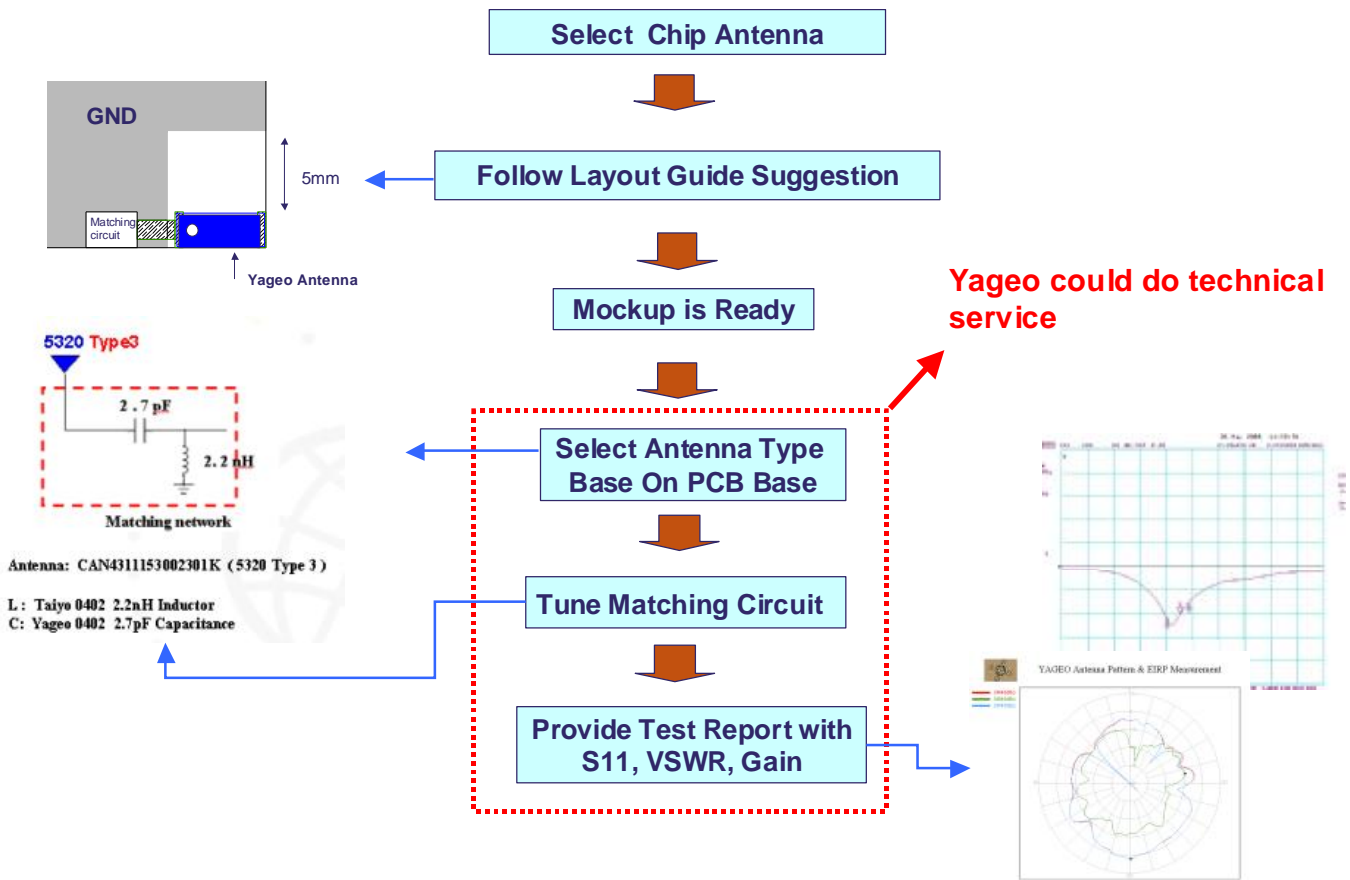

When customer start to use antenna, its better to follow layout guide or talk to Yageo FAE how to do is better. Layout issue is most important since it could affect above 60% of antenna performance. After customer's mockup is ready, Yageo get mockup from customer and could do technical service, such as figure out which type could fit mockup effect, make better performance by tuning matching circuit and provide our test result of S11, VSWR, radiation pattern and Gain.

3.2. Bulk ceramic antenna

3.2.1 Application note



Figure 13 GPS demo board

Comparison with different GPS size

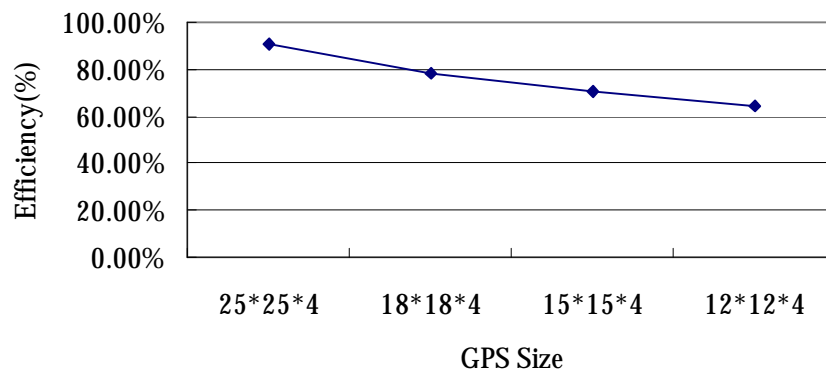

Difference size (mm) tested under 50*50mm ground plane

The bigger size of GPS antenna has better performance on efficiency.

Ground plane issue

1. Center Frequency

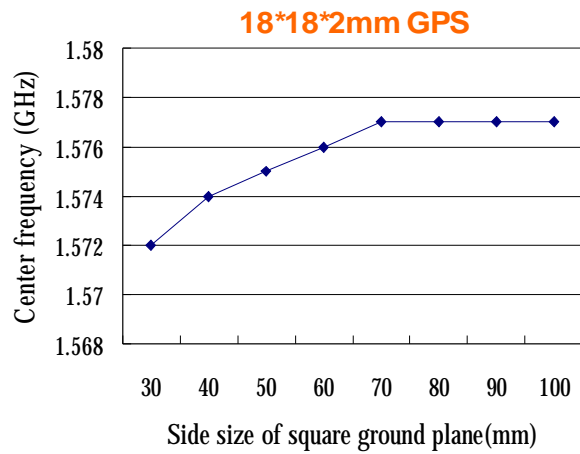
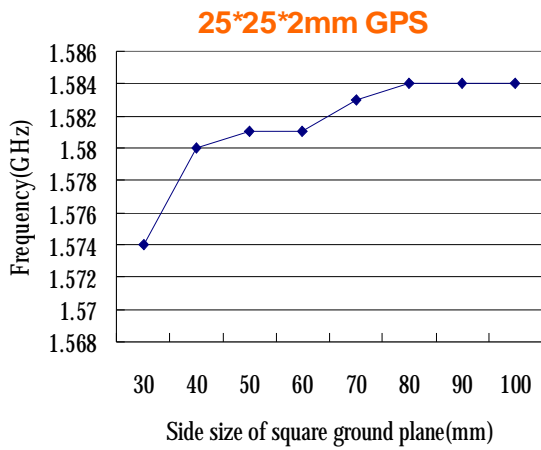

Frequency vs. ground plane

Base on different ground plane, the center frequency will be affected. Fixed the shifted center frequency by tuning design pattern is the only way and we do it for our customer.

2. Efficiency

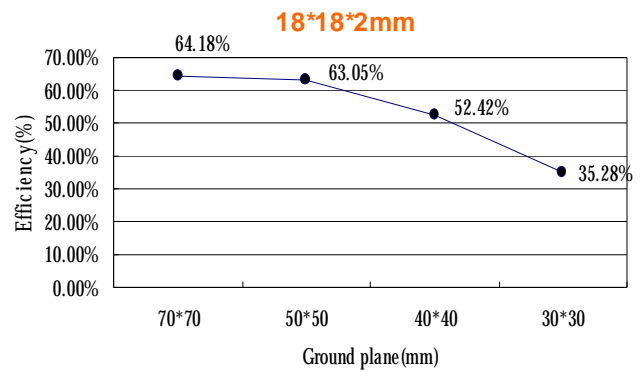
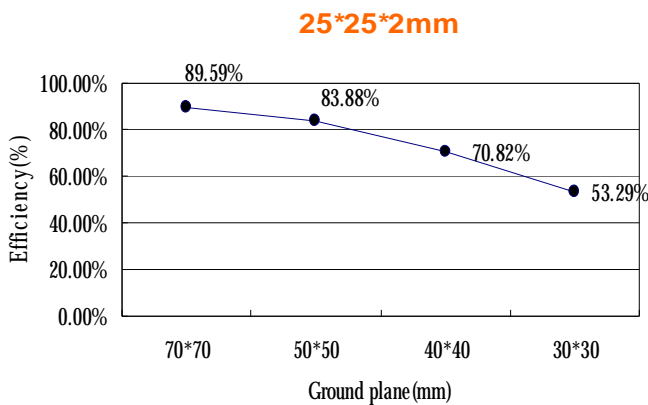

Efficiency vs. ground plane

Not only center frequency but also efficiency will be affected. And generally bigger ground plane have better performance. However, small product that don't have large ground plane is the trend for current consumer product.

3.2.2 Bulk antenna design procedure

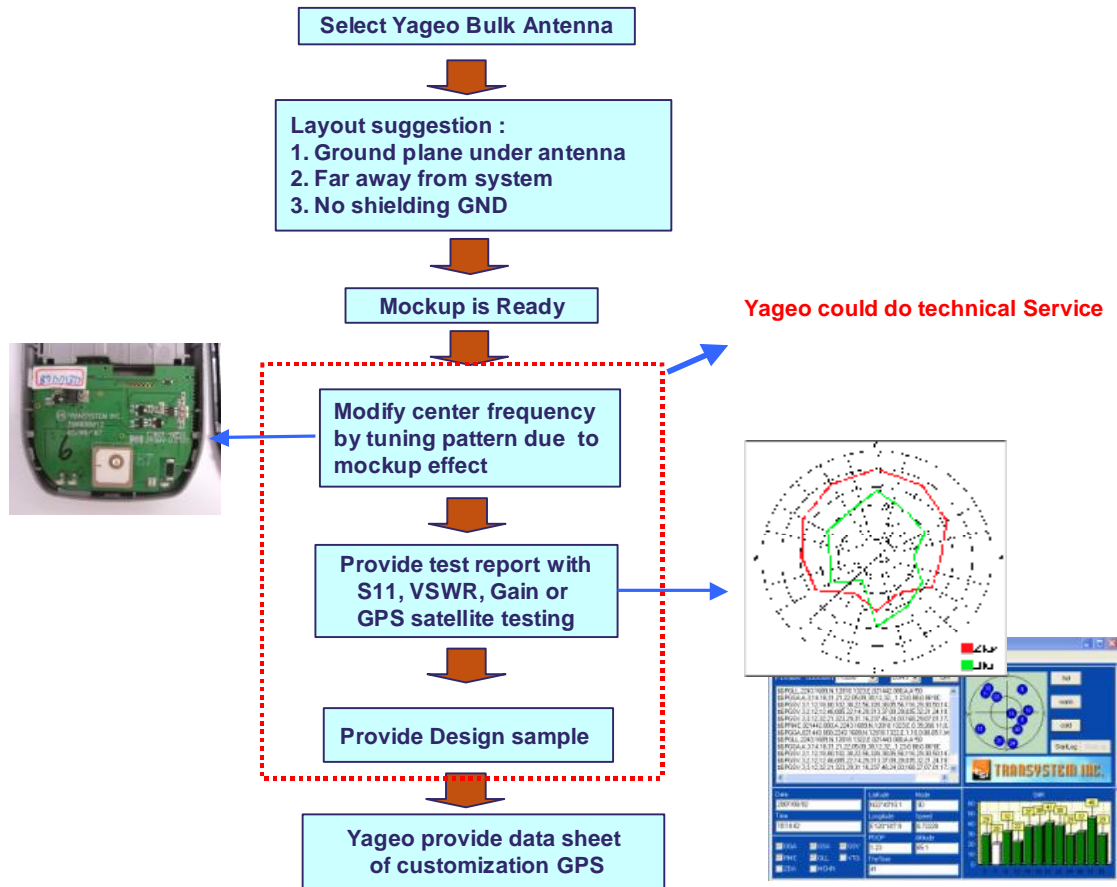

-Bulk antenna is designed from PiFA or patch concept which need ground plane under antenna, and generally the bigger GND plane. Bulk antenna isn't like chip antenna that have multi-pole type. So we directly tune our design pattern to achieve better performance for customer project. Since we tune our pattern for each customer, we will keep our design sample as golden sample for testing spec on mass product.

3.3 Metal Antenna

3.3.1 Metal antenna design procedure

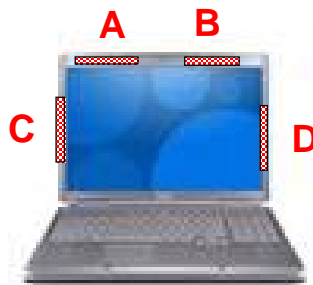

The location where to put with PCB and metal is very important. The common sense is put antenna around edge of the product case, such as A.B, C, and D location. Depend on different antenna design concept for ground plane issue, it's better to discuss with Yageo FAE to find the best solution. When position of antenna is decided and mockup is ready, Yageo could start design antenna and provide our test report around 7 days. And Yageo will create unique p/n of this project for mass product.

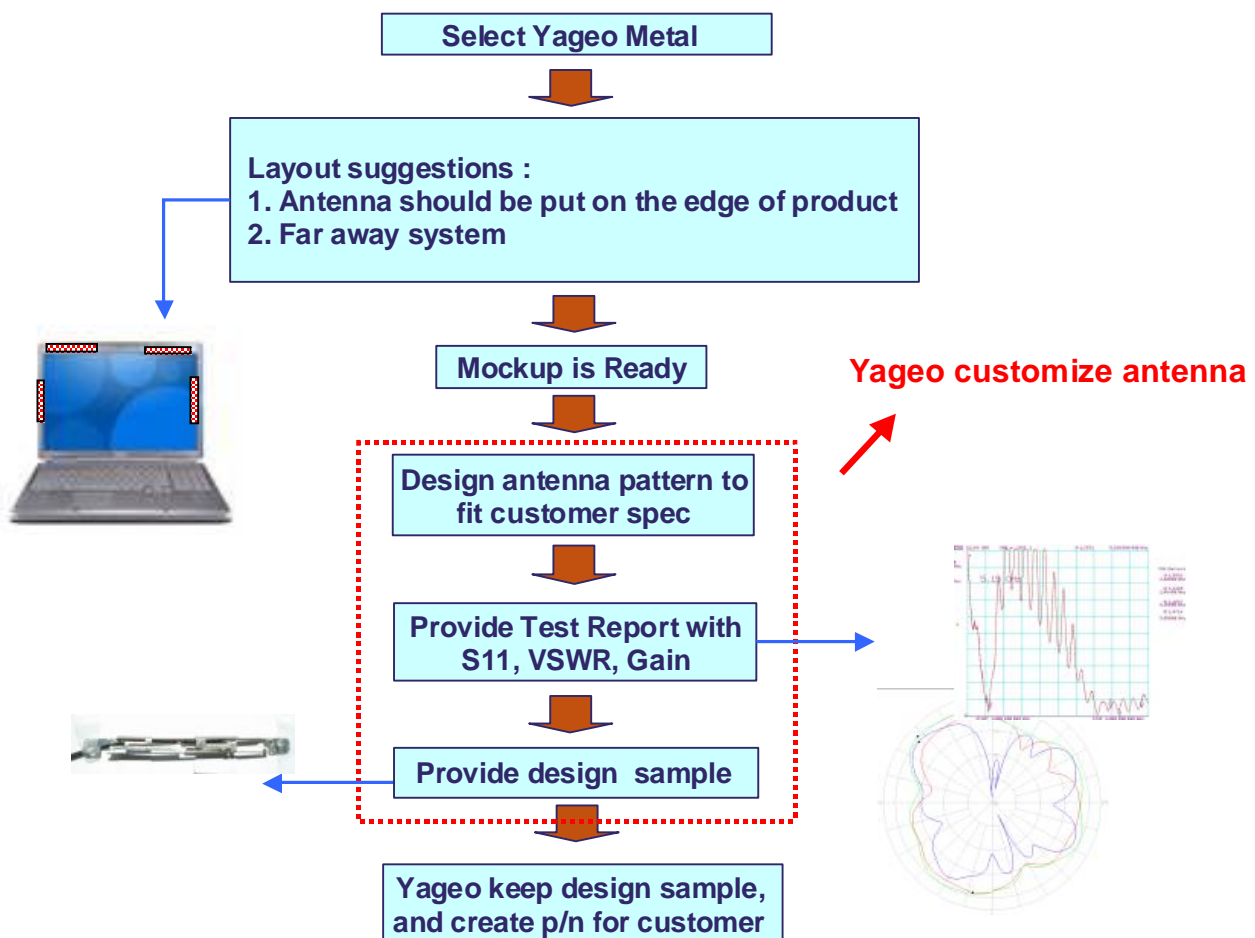

4. LTCC Filter and Balun

4.1. Dual Band RF System Block

Below figure is RF circuit for wireless system and. Balun, LPF, BPF and Diplexer are general applied on RF to solve EMI and signal process.

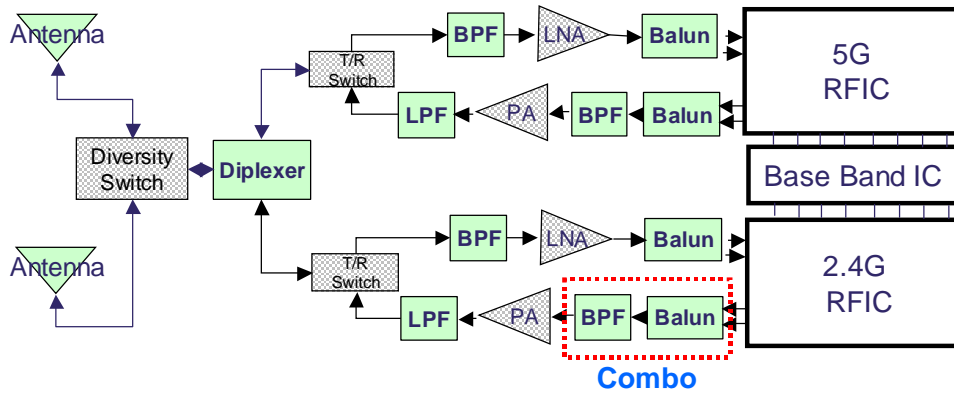

WLAN / Dual band system RF circuit

4.2. Filter and Balun Function

What is Balun

Balun is transformer between RFIC and BPF that have below functions.

1. Unbalance port (single port) to balance port (2 ports)
2. Impedance Transformer, such as below.

Balun 50/50: port 1 =50, port 2 = 25, and port 3= 25 ohm

Balun 50/100: port 1 =50, port 2 = 50, port 3= 50 ohm

Balun 50/200: port 1 =50, port 2 = 100, port 3= 100 ohm

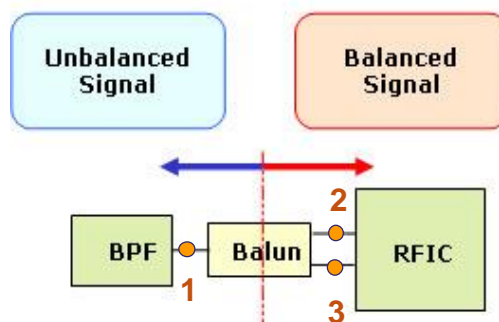

Balun between BPF and RFIC

What is Filter?

Filter is the function that process EMI or noise from system. Figure23 is example of signal in the system. Signal should be suppressed except center frequency.

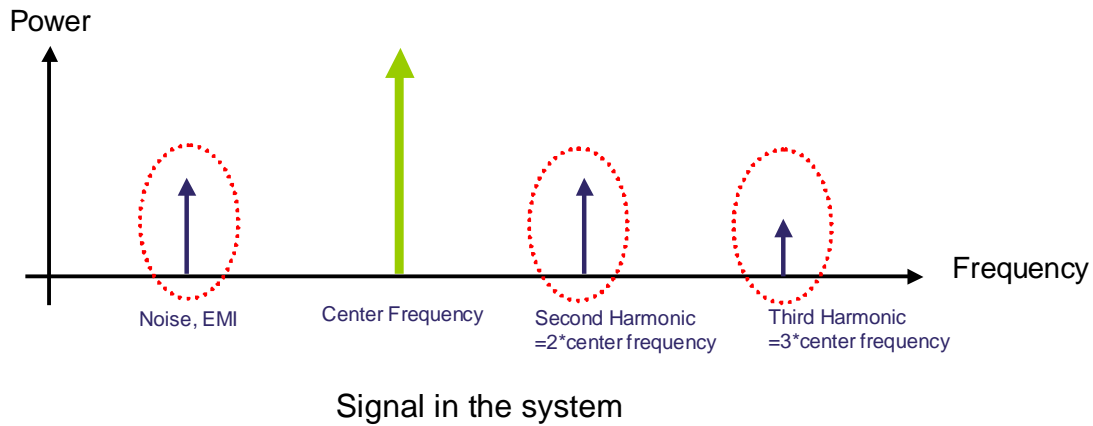

In regard to filter, different functions of filter are developed, seeing below:

LPF (Low Pass Filter)

- High rejection at second harmonic and third harmonic
- Small size
- Low loss

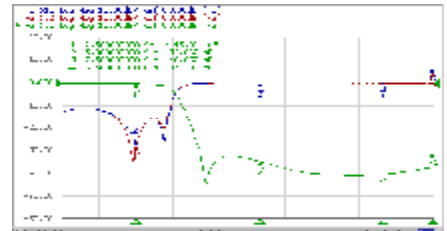

BPF (Band Pass Filter)

- High rejection at second Harmonic and third harmonic
- High rejection at certain frequency for EMI suppress
- High rejection at lower frequency

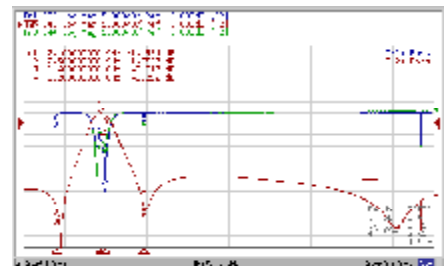

Diplexer

- Integrate either LPF with HPF or LPF with BPF
- Small size, such as 2.0*1.2mm
- Low loss

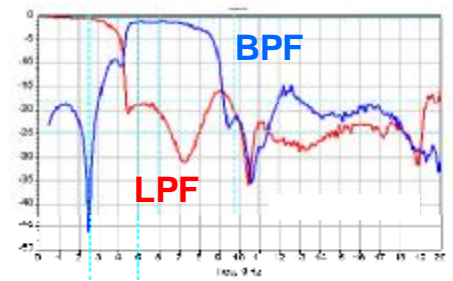
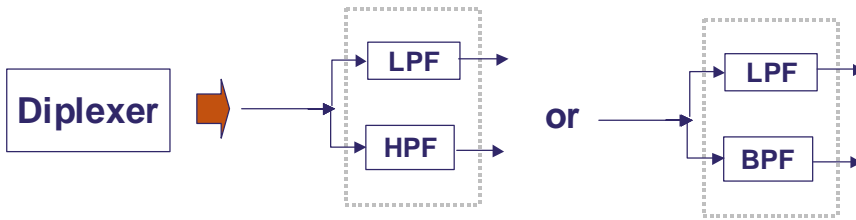

-Combo

- Integrate Balun with BPF
- Could be integrated matching circuit. Such as combo for CSR
- Miniaturize size
- High rejection at second Harmonic and third harmonic
- High rejection at certain frequency for EMI suppress
- High rejection below center frequency

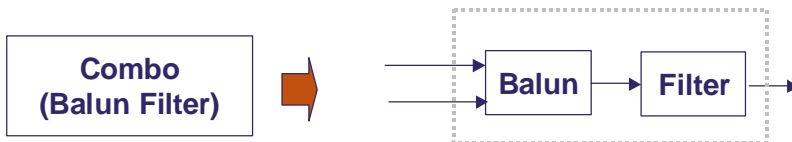
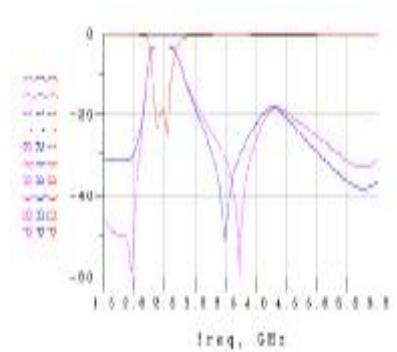

5. High Frequency Cross References

Yageo				Competitor - Cross Ref.				
Freq.	Size	Product	Part Number	Walsin	ACX	Mag. Layers	Johanson	
2.4	1608	LPF	CFL4111 715 50 2454K		LF1608-B2R4KCB_	LTL-1608-2G4S1-A1	2450LP14B100	
	2012	LPF	CFL4111 714 50 2454K			LF2012-B2R4FAB		2450LP15A050
		BPF 03T	CFL4111 714 03 2454K			BF2012-F2R4DAA		
		BPF 05T	CFL4111 714 05 2454K				LTB-2012-2G4H6-A1	
		BPF 06T	CFL4111 714 06 2454K	RFBPF2012090A1T			LTB-2012-2G4H6-A3	
		BALUN50/50	CBA4711 714 00 2454K	RFBLN2012090A0T	BL2012-05B2450_	LTU-2012-2G4S1-A2	2450BL15B050	
		BALUN50/100	CBA4711 714 01 2454K	RFBLN2012090A1T	BL2012-10B2450_	LTU-2012-2G4S1-A2	2450BL15B100	
		BALUN50/200	CBA4711 714 02 2454K	RFBLN2012090A2T	BL2012-20B2450_		2450BL15B200	
		COMBO 67	CBA4711 71467 2454K	RFBPF2012090A1T			BBF-2012-2G4H6-A1	
		COMBO 98	CBA4711 71498 2454K	RFBPF2012090A1T			BBF-2012-2G4H6-A1	
		2520	BPF 02T	CFL4111 713 02 2453K	RFBPF2520120A1T RFBPF2520120A2T	BF2520-B2R4CAB		
	BPF 03T		CFL4111 713 03 2453K		BF2520-B2R4CAC			2450BP39C100B
	BPF 05T		CFL4111 713 05 2453K	RFBPF2520120A3T RFBPF2520120A4T	BF2520-B2R4CAC			2450BP39C100C
	BPF 18T		CFL4111 713 18 2453K		BF2520-B2R4CAE			
	COMBO 91		CBA4711 713 91 2453K	RFBPF2520120A1T	FB2520-10E2R4A_	BBF-2520-2G3H6-A1	2450FB39A050	
	COMBO 93		CBA4711 713 93 2453K	RFBPF2520120A3T	FB2520-07E2RBT	BBF-2520-2G4H6-A1	2450FB39K001	
	COMBO 95		CBA4711 713 95 2453K	RFBPF2520120A3T	FB2520-07E2RBT	BBF-2520-2G4H6-A1	2450FB39K001	
	5	1608	BALUN	CBA4711 715 01 5004K			LTU-1608-5G5S1-A1	
		2012	BPF 01T	CFL4111 714 01 5004K		BF2012-B5R5DAC_		
BPF 05T			CFL4111 714 05 5004K	RFBPF2012100K				
BALUN50/100			CBA4711 714 01 5004K	RFBLN2012090K1T	BL2012-10B5388_	LTU-2012-5G5S1-A1	5512B15B100	
2.4/5	2012	DIPLEXER 80	CFL4111 714 80 2504K	RFDIP2012100L0T	DP2012-B2455BA_ DP2012-E2455BB_			
		DIPLEXER 82	CFL4111 714 82 2504K	RFDIP2012100L2T	DP2012-E2455DA_	LTD-2012-2G4S1-A1		
		DIPLEXER 85	CFL4111 714 85 2504K	RFDIP2012100L1T	DP2012-B2455AA_	LTD-2012-2G4S1-A3		

Yageo				Competitor - Cross Ref. (Japan)				
Freq.	Size	Product	Part Number	Soshin	Murata	TDK	Samsung	
2.4	1608	LPF	CFL4111 715 50 2454K			DEA162500LT-121A1	LCL10T2450A1	
		Balun 5050	CBA4711 715 00 2454K			HHM1710H1		
	2012	LPF	CFL4111 714 50 2454K				LCL21T2450B1	
		BPF 05T	CFL4111 714 05 2454K	HMD843K	LFB212G45SG8A127		LCB21B2450Q1 LCB21B2450Q3	
		BPF 06T	CFL4111 714 06 2454K	HMD846H	LFB212G45SG8A166			
		BALUN50/50	CBA4711 714 00 2454K			HHM1517	LCS21T2450A05 LCS21T2450B05	
		BALUN50/100	CBA4711 714 01 2454K		LDB212G4005C-001 LDB212G4010C-001	HHM1520	LCS21T2450A10 LCS21T2450B10	
		BALUN50/200	CBA4711 714 02 2454K		LDB212G4020C-001	HHM1521	LCS21T2450A20 LCS21T2450B20	
		COMBO 67	CBA4711 71467 2454K	DBF81F101	LFB212G45BA1A220			
		COMBO 98	CBA4711 71498 2454K	DBF81F101	LFB212G45BA1A220			
	2520	BPF 02T	CFL4111 713 02 2453K	MDR 741F MDR 742F	LFB2H2G45SG7A134 LFB2H2G45SG7A135		LCB22B2450L1	
		BPF 03T	CFL4111 713 03 2453K	MDR 746F MDR 774M	LFB2H2G45SG7A158	DEA252450B-2027A1	LCB22B2450C1	
		BPF 05T	CFL4111 713 05 2453K	MDR 774M MDR 743F		DEA252400BT-2030A1	LCB22M2450B1	
		BPF 07T	CFL4111 713 07 2453K	MDR 767F	LFB2H2G45SG7A204 LFB2H2G45SG7B734		LCB22B2450S1	
		COMBO 91	CBA4711 713 91 2453K	DBF 70A001		DEA252450BT-7012D1	LCX22B2450W1	
		COMBO 93	CBA4711 713 93 2453K	DBF71B101		DEA252450BT-7030B1 DEA252450BT-7035B2		
		COMBO 95	CBA4711 713 95 2453K		LFB2H2G45BB1A243			
	5	1608	BALUN	CBA4711 715 01 5004K			HHM1732B1	
		2012	BPF 01T	CFL4111 714 01 5004K		LFB215g37SG8A180	DEA205425BT-1209B2	
			BPF 03T	CFL4111 714 03 5004K		LFB215g37SG8A185		LCB21M5425A1 LCB21M5425B1
BPF 05T			CFL4111 714 05 5004K	HMD861H				
BALUN50/100			CBA4711 714 01 5004K		LDB215G3710C001 LDB215G5110C001	HHM1562B		
2.4/5	2012	DIPLEXER 80	CFL4111 714 80 2504K	HMD 880J HMD 888J			DX21THWC01	
		DIPLEXER 82	CFL4111 714 82 2504K	HMD 881j		DPX205950DT-9108A1	DX21TFWC12	
		DIPLEXER 85	CFL4111 714 85 2504K		LFD212G45DP3A151 LFD212G45DP3A188			
		DIPLEXER 86	CFL4111 714 86 2504K		LFD212G45DP3A189			
		DIPLEXER 88	CFL4111 714 88 2504K	HMD 888J		DPX205950DT-9008A1		

Innovative Services Around the Globe

YAGEO

6. Appendix 1: Antenna Characteristic

VSWR and Reflected Power

The Voltage Standing Wave Ratio (VSWR) is an indication of how good the impedance match is. VSWR is often abbreviated as SWR. A high VSWR is an indication that the signal is reflected prior to being radiated by the antenna. VSWR and reflected power are different ways of measuring and expressing the same thing.

VSWR	Power Reflection
Infinte	100.0%
5.84	50.0%
3.01	25.0%
2.09	12.5%
1.92	10.0%
1.67	6.3%
1.43	3.1%
1.29	1.6%
1.22	1.0%
1.06	0.1%

Radiation pattern

The antenna radiation pattern is a graphic description in two (2D) or three dimensions (3D) representation of the relative field strength transmitted or received by the antenna.

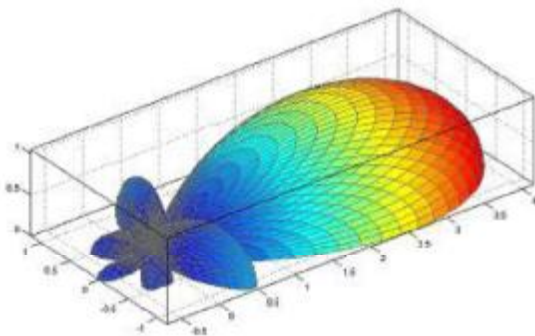

3D radiation pattern

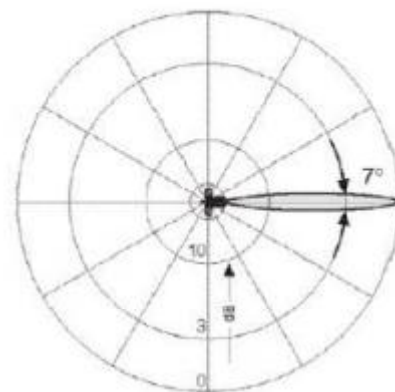

2D radiation pattern

Isotropic antenna

An antenna pattern is defined by uniform radiation in all directions, produced by an isotropic radiator (point source, a non-physical antenna which is the only nondirectional antenna).

Directional antenna

It has the property of radiating or receiving signal more effectively in some directions than in others. .

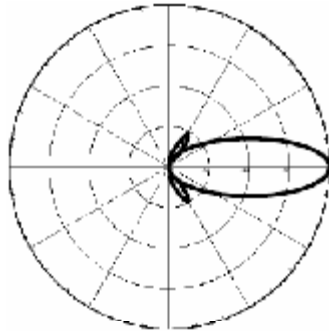

Omnidirectional antenna

It has a nondirectional pattern in azimuth and a directional pattern in elevation, such as Dipole antenna.

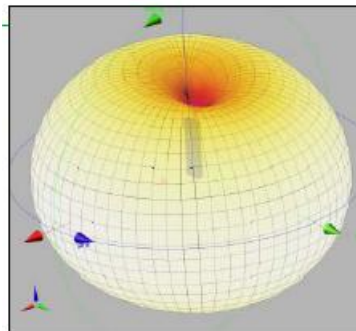

E-plane and H-plane patterns

E-plane pattern is the plane containing the electric field vector and the direction of maximum radiation. H-plane pattern is the plane containing the magnetic-field vector and the direction of maximum radiation.

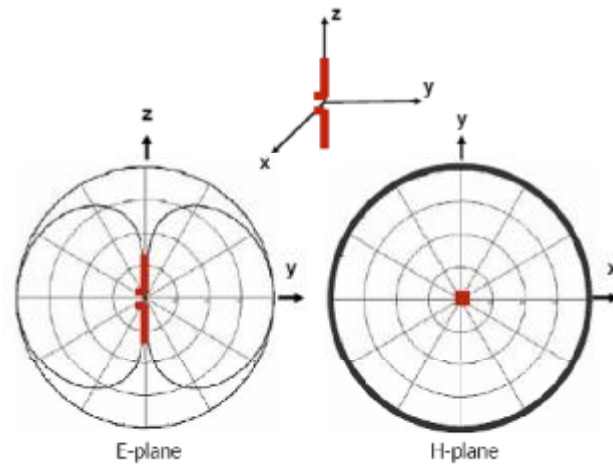

Polarization

Polarization is defined as the orientation of the electric field of an electromagnetic wave.

- Linear polarization
 - Circular polarization
 - RHCP (right-hand circular polarization)
 - LHCP (left-hand circular polarization)
 - Elliptical polarization

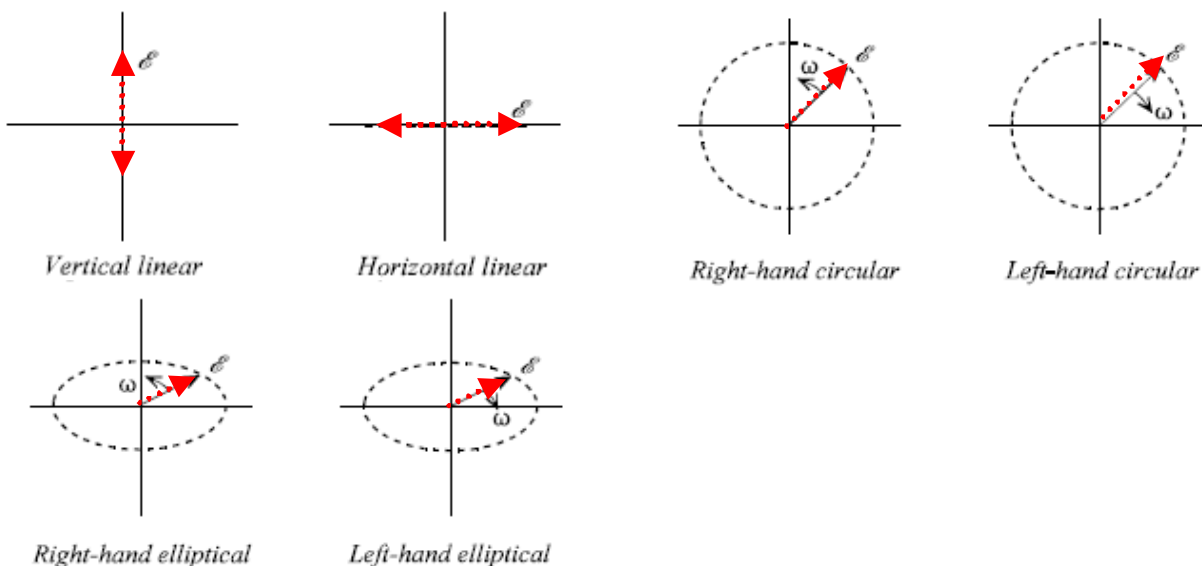

Antenna efficiency

Efficiency (e_{cd}) is a figure showing the ratio of the total radiated power (P_{rad}) to the total input Power (P_{in}). Efficiency has no unit and the ideal figure is 1.

$$e_{cd} = \frac{P_{rad}}{P_{in}}$$

8. Appendix 2: Designer Sample Kit

Surface-mount Ceramic Multilayer Antenna

8010 size new released for 2.4GHz WPAN/ WLAN

Product Description	Part number	Dimension
Bluetooth Multilayer Ceramic Antenna Type245	CAN4311111002451K	L:7.3 ; W:5.5 ; T:1.30mm
Bluetooth Multilayer Ceramic Antenna Type260	CAN4311111002601K	L:7.3 ; W:5.5 ; T:1.30mm
Bluetooth Multilayer Ceramic Antenna Type270	CAN4311111002701K	L:7.3 ; W:5.5 ; T:1.30mm
Bluetooth Multilayer Ceramic Antenna Type280	CAN4311111002801K	L:7.3 ; W:5.5 ; T:1.30mm
Bluetooth Multilayer Ceramic Antenna Type290	CAN4311111002901K	L:7.3 ; W:5.5 ; T:1.30mm
8010/2.45GHz WLAN/Bluetooth Ceramic Antenna, type5	CAN4311181052453K	L:8.0 ; W:1.0 ; T:1.0mm
8010/2.45GHz WLAN/Bluetooth Ceramic Antenna, type6	CAN4311181062453K	L:8.0 ; W:1.0 ; T:1.0mm
8010/2.45GHz WLAN/Bluetooth Ceramic Antenna, type7	CAN4311181072453K	L:8.0 ; W:1.0 ; T:1.0mm
8010/2.45GHz WLAN/Bluetooth Ceramic Antenna, type5	CAN4311881052453K	L:8.0 ; W:1.0 ; T:1.0mm
8010/2.45GHz WLAN/Bluetooth Ceramic Antenna, type6	CAN4311881062453K	L:8.0 ; W:1.0 ; T:1.0mm
8010/2.45GHz WLAN/Bluetooth Ceramic Antenna, type7	CAN4311881072453K	L:8.0 ; W:1.0 ; T:1.0mm
7836/2.45GHz WLAN/Bluetooth Ceramic Antenna(4pad),type245	CAN4311115002451K	L:7.8 ; W:3.6 ; T:0.9mm
7836/2.45GHz WLAN/Bluetooth Ceramic Antenna(4pad),type260	CAN4311115002601K	L:7.8 ; W:3.6 ; T:0.9mm
7836/2.45GHz WLAN/Bluetooth Ceramic Antenna(8pad),type260	CAN4311115112601K	L:7.8 ; W:3.6 ; T:0.9mm
7836/2.45GHz WLAN/Bluetooth Ceramic Antenna(4pad),type270	CAN4311115002701K	L:7.8 ; W:3.6 ; T:0.9mm
5320/2.45GHz WLAN/Bluetooth Ceramic Antenna (type 0)	CAN4311153002001K	L:5.3 ; W:2.0 ; T:1.3mm
5320/2.45GHz WLAN/Bluetooth Ceramic Antenna (type 1)	CAN4311153002101K	L:5.3 ; W:2.0 ; T:1.3mm
5320/2.45GHz WLAN/Bluetooth Ceramic Antenna (type 2)	CAN4311153002201K	L:5.3 ; W:2.0 ; T:1.3mm
5320/2.45GHz WLAN/Bluetooth Ceramic Antenna (type 3)	CAN4311153002301K	L:5.3 ; W:2.0 ; T:1.3mm
5320/2.45GHz WLAN/Bluetooth Ceramic Antenna (type 4)	CAN4311153002401K	L:5.3 ; W:2.0 ; T:1.3mm
5320/2.45GHz WLAN/Bluetooth Ceramic Antenna (type N)	CAN4311153002451K	L:5.3 ; W:2.0 ; T:1.3mm
5320/2.45GHz WLAN/Bluetooth Ceramic Antenna (type 5)	CAN4311153002501K	L:5.3 ; W:2.0 ; T:1.3mm
3216/2.45GHz WLAN/Bluetooth Ceramic Antenna (type N)	CAN4311712002453K	L:3.2 ; W:1.6 ; T:1.2mm
3216/2.45GHz WLAN/Bluetooth Ceramic Antenna (type 2)	CAN4311712022453K	L:3.2 ; W:1.6 ; T:1.2mm
3216/2.45GHz WLAN/Bluetooth Ceramic Antenna (type 3)	CAN4311712032453K	L:3.2 ; W:1.6 ; T:1.2mm
3216/2.45GHz WLAN/Bluetooth Ceramic Antenna (type 4)	CAN4311712042453K	L:3.2 ; W:1.6 ; T:1.2mm

Surface-mount Ceramic Multilayer Antenna

Product Description	Part number	Dimension
433MHz Ceramic Antenna	CAN4311121200431K	L:37.5 ; W:6.8 ; T:0.9mm
433MHz Ceramic Antenna(type 1),small size	CAN4311129200431K	L:12.0 ; W:4.0 ; T:1.5mm
460MHz Antenna,Bulk	CAN4311121200461K	L:37.5 ; W:6.8 ; T:0.9mm
490MHz Antenna,Bulk	CAN4311121200491K	L:37.5 ; W:6.8 ; T:0.9mm
570MHz Antenna,Bulk	CAN4313135200571B	L:29.0 ; W:6.8 ; T:0.9mm
870MHz Ceramic Antenna	CAN4313119000871B	L:16.5 ; W:14.0 ; T:0.9mm
870MHz , Antenna type 7 (small size)	CAN4311129070871K	L:12.1 ; W:4.1 ; T:1.6mm
870MHz , Antenna type 8 (small size)	CAN4311129080871K	L:12.1 ; W:4.1 ; T:1.6mm
870MHz , Antenna type 9 (small size)	CAN4311129090871K	L:12.1 ; W:4.1 ; T:1.6mm
900/1800MHz Dual Band Ceramic Antenna	CAN4313118009181B	L:21.0 ; W:12.0 ; T:0.9mm
900/1800MHz Dual Band Ceramic Antenna (small size)	CAN4311116009181K	L:12.0 ; W:4.4 ; T:1.2mm
1.88 GHz DECT/WCDMA Antenna	CAN4311112001881K	L:9.00 ; W:7.0 ; T:0.9mm
6230/1.575GHz GPS Patch Antenna(type A)	CAN4311113011582K	L:6.15 ; W:3.0 ; T:1.25mm
6230/1.575GHz GPS Patch Antenna(type B)	CAN4311113021582K	L:6.15 ; W:3.0 ; T:1.25mm
6230/1.575GHz GPS Patch Antenna(type C)	CAN4311113031582K	L:6.15 ; W:3.0 ; T:1.25mm
UWB Ceramic Antenna (type 1)	CAN4311125402591K	L:11.0 ; W:5.3 ; T:1.2mm
UWB Ceramic Antenna (type 2)	CAN4311127402591K	L:11.0 ; W:10.0; T:1.2mm

Yageo LTCC Antenna-

World's Smallest for Bluetooth / WLAN Application

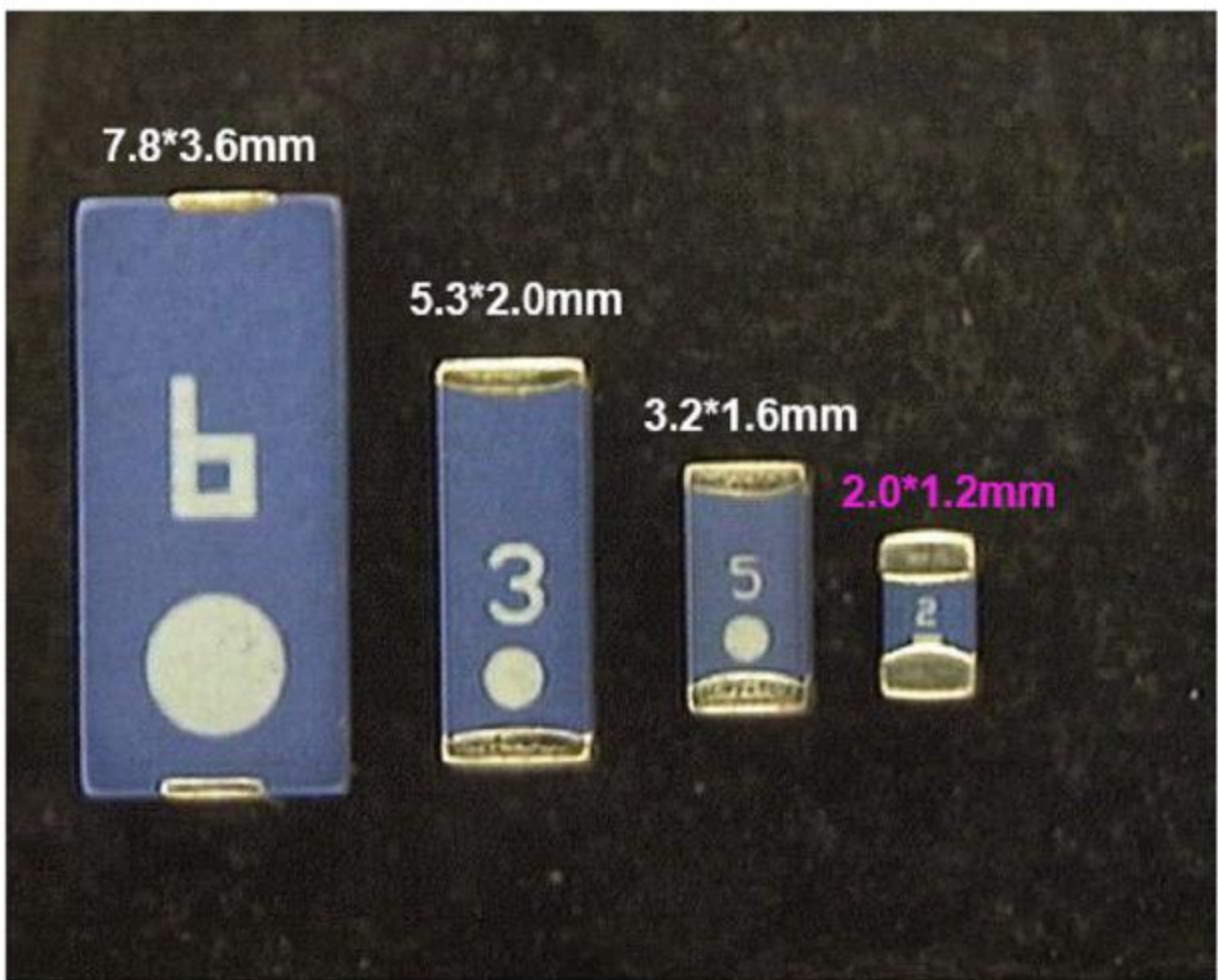

Bluetooth/WLAN (2.45 GHz) Antenna

2012 / 2.45GHz Bluetooth/WLAN Antenna
CAN4311714002454K

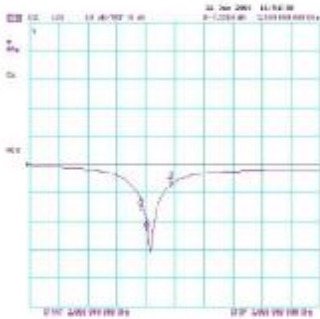

Description	Value
Centre Frequency	2.45 GHz
Bandwidth	at least 70 MHz
VSWR	2.5 (Max.)
Polarization	Linear
Azimuth Beamwidth	Omni-directional
Peak Gain	2 dBi
Impedance	50 Ω
Operating Temperature	-25-85 °C
Termination	Ni / Sn
Resistance to soldering heats	260°C, 10sec.
Dimension	2.0 x 1.2 x 1.1 mm

3216 / 2.45GHz Bluetooth/WLAN Antenna
CAN4311712002453K

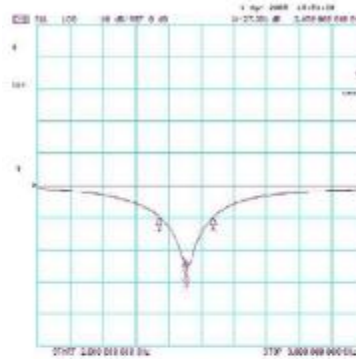

Description	Value
Centre Frequency	2.45 GHz
Bandwidth	at least 100 MHz
VSWR	2.5 (Max.)
Polarization	Linear
Azimuth Beamwidth	Omni-directional
Peak Gain	3.1 dBi
Impedance	50Ω
Operating Temperature	-25-85 °C
Termination	Ni / Sn
Resistance to soldering heats	260°C, 10sec.
Dimension	3.2 x 1.6 x 1.2 mm

5320 / 2.45GHz Bluetooth/WLAN Antenna
CAN4311153002451K

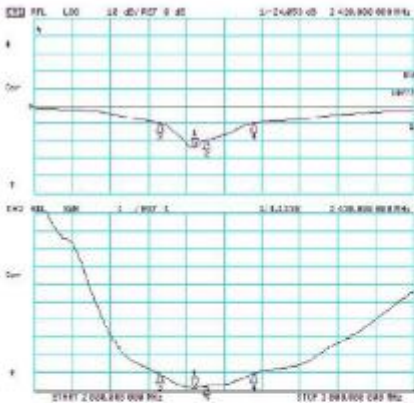

Description	Value
Centre Frequency	2.45 GHz
Bandwidth	at least 200 MHz
VSWR	2 (Max.)
Polarization	Linear
Azimuth Beamwidth	Omni-directional
Peak Gain	4 dBi
Impedance	50Ω
Operating Temperature	-25-85 °C
Termination	Ni / Sn
Resistance to soldering heats	260°C, 10sec.
Dimension	5.3 x 2.0 x 1.25 mm

7836 / 2.45GHz Bluetooth/WLAN Antenna
CAN431115002451K

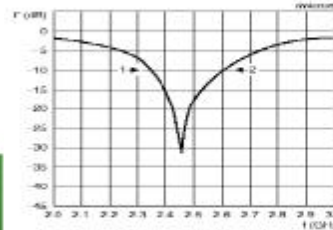

Marker data:
1: f = -10 dB, A = 2.50 GHz
2: f = -10 dB, A = 2.56 GHz

Description	Value
Centre frequency (for different central frequency shifts)	2.45 GHz
Bandwidth	> 100 MHz
Gain	4.1 dBi max. (depends on the special environment)
VSWR	2.5 max. (depends on the special environment)
Polarization	Linear
Azimuth beamwidth	Omni-directional
Impedance	50 W
Power dissipation	1 W
Operating temperature	-25 to +85 °C
Terminations	Ni/Sn
Resistance to soldering heat	260 °C for 10 seconds

GPS (1.575 GHz)Antenna

6230 / 1.575GHz GPS Ceramic Antenna
CAN4311113011582K

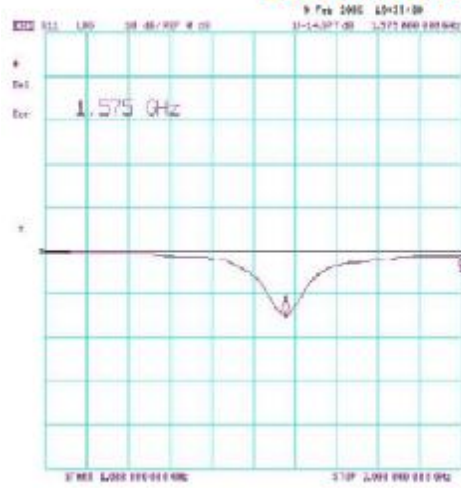

Description	Value
Centre Frequency	1.575GHz
Bandwidth	at least 100 MHz
VSWR	2 (Max.)
Polarization	Linear
Azimuth Beamwidth	Omni-directional
Peak Gain	1.5 dBi
Impedance	50Ω
Operating Temperature	-25~85 °C
Termination	Ni / Sn
Resistance to soldering heats	260°C , 10sec.
Dimension	6.15 x 3.0 x 1.25 mm

UWB Antenna

2.0-6GHz UWB Ceramic Antenna
CAN4311125402591K

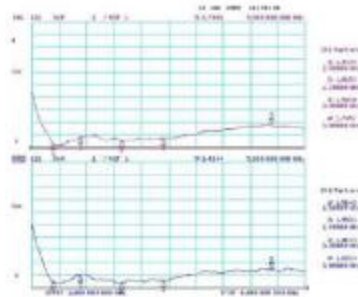

Description	Value
Centre Frequency	4.0 GHz
Bandwidth	at least 4 GHz
VSWR	2.5 (Max.)
Polarization	Linear
Azimuth Beamwidth	Omni-directional
Peak Gain	5.0 dBi
Impedance	50Ω
Operating Temperature	-25-85 °C
Termination	Ni / Sn
Resistance to soldering heats	260°C, 10sec.
Dimension	11.0 x 5.3 x 1.2 mm

433 MHz Antenna

433MHz Ceramic Antenna
CAN43111292004312K

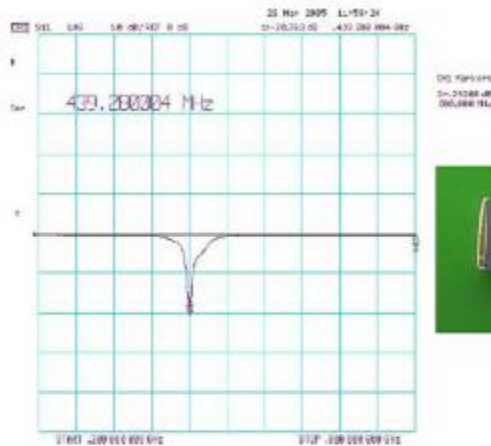

Description	Value
Centre Frequency	400 - 500 MHz
Bandwidth	at least 20 MHz
VSWR	3.0 (Max.)
Polarization	Linear
Azimuth Beamwidth	Omni-directional
Peak Gain	0.5 dBi
Impedance	50Ω
Operating Temperature	-25-85 °C
Termination	Ni / Sn
Resistance to soldering heats	260°C, 10sec.
Dimension	12.0 x 4.0 x 1.5 mm

570 MHz Antenna

570 MHz Ceramic Antenna
CAN4313135000571B

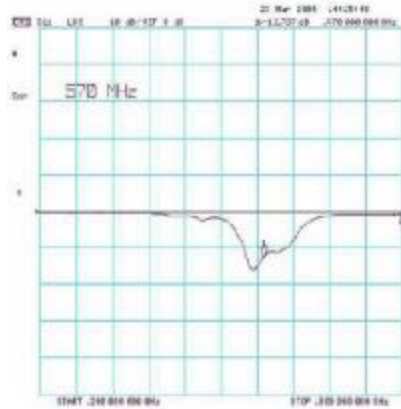

Old Partno:
20-27788-00
20-27789-00



Description	Value
Centre Frequency	570 MHz
Bandwidth	at least 80 MHz
VSWR	2.0 Max
Polarization	Linear
Azimuth Beamwidth	Omnidirectional
Peak Gain	
Impedance	50 Ω
Operating Temperature	-40~125 °C
Termination	Ni/Sn
Resistance to soldering heats	260 °C, 10sec
Dimension	6.8 x 29 x 1.2

870 MHz Antenna

870 MHz Ceramic Antenna
CAN4313129070871K

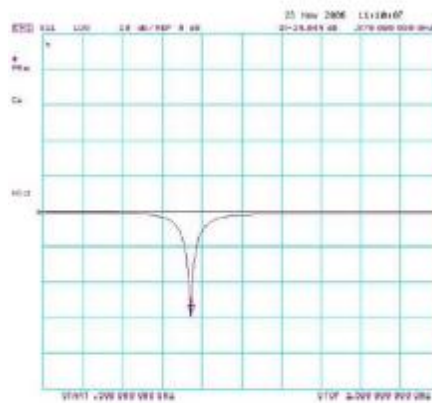

Description	Value
Centre Frequency	800-900 MHz
Bandwidth	at least 20 MHz
VSWR	2.0 Max
Polarization	Linear
Azimuth Beamwidth	Omnidirectional
Peak Gain	0.5 dBi Max
Impedance	50 Ω
Operating Temperature	-40~125 °C
Termination	Ni/Sn
Resistance to soldering heats	260 °C, 10sec
Dimension	4.0 x 12.0 x 1.6

GPS Ceramic Patch Antenna / Active Antenna

New approved series for MTK chipset solution

1818 / 1.575GHz GPS Patch Antenna (CP/Pin type)	CAN4313424031581B	L:18.0 ; W:18.0 ; T:4.0mm
1818 / 1.575GHz GPS Patch Antenna (CP/SMD type)	CAN4313424061581B	L:18.0 ; W:18.0 ; T:4.0mm
1818 / 1.575GHz GPS Patch Antenna (CP/SMD type)	CAN4313424071581B	L:18.0 ; W:18.0 ; T:2.0mm
2525 / 1.575GHz GPS Patch Antenna (CP/Pin type)	CAN4313425021581B	L:25.0 ; W:25.0 ; T:2.0mm
2525 / 1.575GHz GPS Patch Antenna (CP/Pin type)	CAN4313425031581B	L:25.0 ; W:25.0 ; T:4.0mm
1044 / 1.575GHz GPS Patch Antenna (CP/Pin type)	CAN4311231021581K	L:10.0 ; W:4.0 ; T:4.0mm
1212 / 1.575GHz GPS Patch Antenna (CP/Pin type)	CAN4313422261581B	L:12.0 ; W:12.0 ; T:4.0mm
1515 / 1.575GHz GPS Patch Antenna (CP/Pin type)	CAN4313423261581B	L:15.0 ; W:15.0 ; T:4.0mm
1212 GPS Active Antenna (SAW + 1 stage LNA)	CAN4313434621581B	L:12.0 ; W:12.0 ; T:7.0mm
1515 GPS Active Antenna (SAW + 1 stage LNA)	CAN4313435621581B	L:15.0 ; W:15.0 ; T:7.0mm
2115 / 1.575GHz GPS Active Antenna	CAN4313435911581B	L:21.5 ; W:15.0 ; T:7.5mm
2115 / 1.575GHz GPS Active Antenna	CAN4313435951581B	L:21.5 ; W:15.0 ; T:7.5mm
1919 / 1.575GHz GPS Active Antenna	CAN4313437931581B	L:19.0 ; W:19.0 ; T:7.5mm
1919 / 1.575GHz GPS Active Antenna	CAN4313437951581B	L:19.0 ; W:19.0 ; T:5.5mm
1616 GPS Active Antenna (1 stage of LNA)	CAN4313435921581B	L:16.0 ; W:16.0 ; T:7.5mm
1616 GPS Active Antenna (2 stage of LNA)	CAN4313435941581B	L:16.0 ; W:16.0 ; T:7.5mm
1313 GPS Active Antenna	CAN4313434881581B	L:13.0 ; W:13.0 ; T:5.5mm
1313 GPS Active Antenna	CAN4313434861581B	L:13.0 ; W:13.0 ; T:7.5mm
4545 GPS Active Antenna (waterproof housing)	CAN4313450011581B	L:45.0 ; W:45.0 ; T:15.0mm

Circular Polarization GPS Antenna (Bulk)

1212 / 1.575GHz GPS Ceramic Patch Antenna
CAN4313 422 021581B
CAN4313 422 031581B

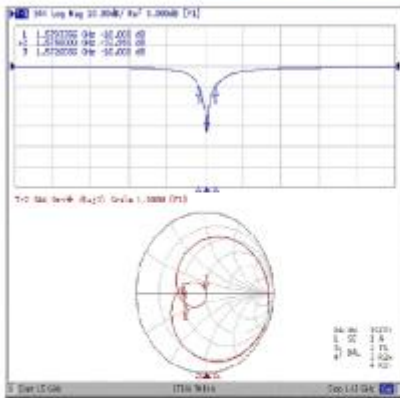

Description	Value
Frequency Range	1.575 GHz
Bandwidth	9 MHz
Gain	1 dBi
V.S.W.R.	2.5 Max
Polarization	Right Hand Circular Polarization
Axis Ratio	< 3dB
Impedance	50Ω
Operating Temperature	-25~125℃

1515 / 1.575GHz GPS Ceramic Patch Antenna
CAN4313 423 021581B
CAN4313 423 031581B

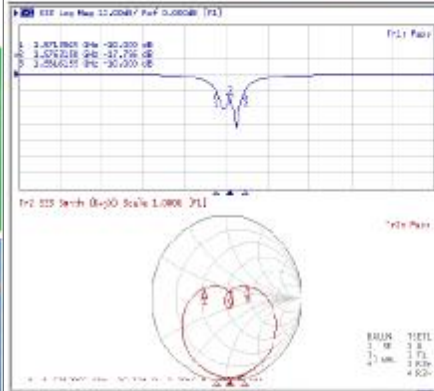

Description	Value
Frequency Range	1.575 GHz
Bandwidth	8 MHz min
Gain	2.5dBi Max
V.S.W.R.	2.0 Max
Polarization	Right Hand Circular Polarization
Axis Ratio	less than 3dB for the centre frequency
Impedance	50Ω
Operating Temperature	-55~125℃

1818 / 1.575GHz GPS Ceramic Patch Antenna
CAN4313 424 031581B

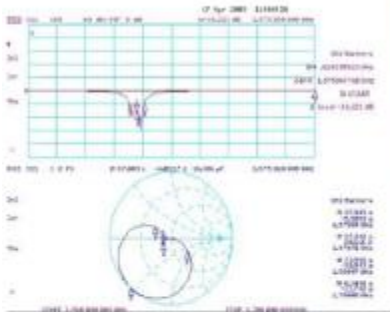

Description	Value
Centre Frequency	1.575 GHz
Bandwidth	10MHz
VSWR	2.5 (Max.)
Polarization	Right Hand Circular Polarization
Peak Gain	2.5 dBi
Impedance	50Ω
Operating Temperature	-25~85 oC
Resistance to soldering heats	260℃, 10sec.
Dimension	18.0 x 18.0 x 4.0 mm

2525 / 1.575GHz GPS Ceramic Patch Antenna
CAN4313425021581B
CAN4313425031581B



Description	Value
Centre Frequency	1.575 GHz
Bandwidth	20MHz
VSWR	2.5 (Max.)
Polarization	Right Hand Circular Polarization
Peak Gain	5 dBi
Impedance	50Ω
Operating Temperature	-25~85 oC
Resistance to soldering heats	260℃, 10sec.
Dimension	25.0 x 25.0 x 4.0, 2.0 mm

Linear Polarization GPS Antenna (Bulk)

1044 / 1.575GHz GPS Ceramic Patch Antenna
CAN4311231021581K

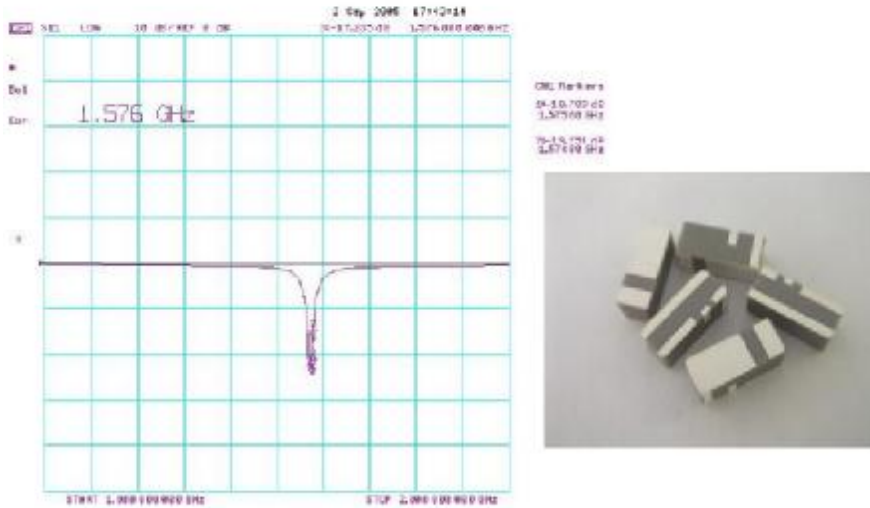

Description	Value
Centre Frequency	1.575 GHz
Bandwidth	10MHz
VSWR	2.0 (Max.)
Polarization	Linear Polarization
Peak Gain	1 dBi
Impedance	50Ω
Operating Temperature	-25~85 oC
Resistance to soldering heats	260℃ , 10sec.
Dimension	10.0 x 4.0 x 4.0 mm

GPS Active Antenna

1919 / 1.575GHz GPS Ceramic Active Antenna
CAN 431343793158 1B

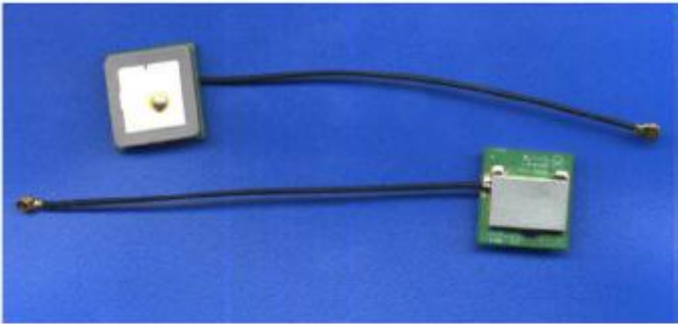

Ceramic Patch Antenna

Outline Dimension:	18*18*4 mm (Ceramic Patch)
Ground Plane	18.5*18.5*0.15 mm
Central Frequency	1575 +/- 3MHz
Impedance	50 Ohm
Gain	+2.5 dBi (Elevation 90 degree)
VSWR	2.0 max
Polarization	Right Hand Circular Polarization
Axis Ratio	3dB max. (Elevation 90 degree)

LNA

Central Frequency	1575 +/- 3 MHz
Gain	30 +/- 1 dBi (at fc, without SAW filter)
Noise Figure	1.5 dB typ. (at fc, 1.8dB Max)
Output VSWR	2.0 (at fc)
Supply Voltage	3.3 +/- 5% V
Current Consumption	6 mA
Output Impedance	50 Ohm
Operating Temperature/Humidity	-30 - +85 °C ; < 95%
Storage Temperature	-40 - +125 °C

2115 / 1.575GHz GPS Ceramic Active Antenna
CAN 431343591158 1B

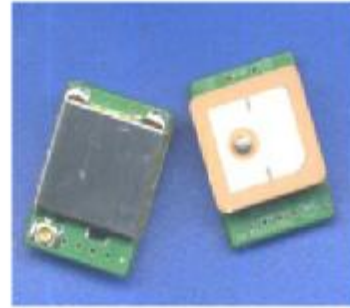

Ceramic Patch Antenna

Outline Dimension:	15*15*4 mm (Ceramic Patch)
Ground Plane	15.5*15.5*0.15 mm
Central Frequency	1575 +/- 3MHz
Impedance	50 Ohm
Gain	+2.0 dBi (Elevation 90 degree)
VSWR	2.0 max
Polarization	Right Hand Circular Polarization
Axis Ratio	3dB max. (Elevation 90 degree)

LNA

Central Frequency	1575 +/- 3 MHz
Gain	16 +/- 1 dBi (at fc, without SAW filter)
Noise Figure	1.5 dB typ. (at fc, 1.8dB Max)
Output VSWR	2.0 (at fc)
Supply Voltage	3.3 +/- 5% V
Current Consumption	5 mA (typ. 2.5-3 mA)
Output Impedance	50 Ohm
Operating Temperature/Humidity	-30 - +85 °C ; < 95%
Storage Temperature	-40 - +125 °C

Surface-mount Ceramic Multilayer Filter

Product Description	Part number	Dimension
2520 / 2.45GHz Bluetooth /WLAN Band Pass Filter	CFL4111713022453K	L:2.5 ; W:2.0 ; T:0.95mm
2520 / 2.45GHz Bluetooth /WLAN Band Pass Filter	CFL4111713032453K	L:2.5 ; W:2.0 ; T:0.95mm
2520 / 2.45GHz Bluetooth /WLAN Band Pass Filter	CFL4111713052453K	L:2.5 ; W:2.0 ; T:1.10mm
2520 / 2.45GHz Bluetooth /WLAN Band Pass Filter	CFL4111713072453K	L:2.5 ; W:2.0 ; T:1.20mm
2520 / 2.45GHz Bluetooth /WLAN Band Pass Filter	CFL4111713122453K	L:2.5 ; W:2.0 ; T:1.15mm
2520 / 2.45GHz Bluetooth /WLAN Band Pass Filter	CFL4111713182453K	L:2.5 ; W:2.0 ; T:0.95mm
2012 / 2.45GHz Bluetooth /WLAN Band Pass Filter	CFL4111714032454K	L:2.0 ; W:1.25 ; T:0.90mm
2012 / 2.45GHz Bluetooth /WLAN Band Pass Filter	CFL4111714052454K	L:2.0 ; W:1.25 ; T:0.90mm
2012 / 2.45GHz Bluetooth /WLAN Band Pass Filter	CFL4111714062454K	L:2.0 ; W:1.25 ; T:0.85mm
2012 / 2.45GHz Bluetooth /WLAN Band Pass Filter	CFL4111714182454K	L:2.0 ; W:1.25 ; T:1.10mm
2012 / 2.45GHz Bluetooth /WLAN Band Pass Filter	CFL4111714192454K	L:2.0 ; W:1.25 ; T:0.90mm
2012 / 2.45GHz Bluetooth /WLAN Band Pass Filter	CFL4111714992454K	L:2.0 ; W:1.25 ; T:0.90mm
2012 / 2.6GHz Wimax Band Pass Filter	CFL4111714162604K	L:2.0 ; W:1.25 ; T:0.90mm
2012 / 5GHz WLAN Band Pass Filter	CFL4111714015004K	L:2.0 ; W:1.25 ; T:1.00mm
2012 / 5GHz WLAN Band Pass Filter	CFL4111714035004K	L:2.0 ; W:1.25 ; T:0.85mm
2012 / 5GHz WLAN Band Pass Filter	CFL4111714055004K	L:2.0 ; W:1.25 ; T:0.90mm
1608 / 2.45GHz Bluetooth /WLAN Band Pass Filter	CFL4111715012454K	L:1.6 ; W:0.80 ; T:0.65mm
2012 / 2.45GHz Bluetooth /WLAN Low Pass Filter	CFL4111714502454K	L:2.0 ; W:1.25 ; T:0.85mm
2012 / 3.5GHz Wimax Low Pass Filter	CFL4111714503504K	L:2.0 ; W:1.25 ; T:0.85mm
2012 / 5GHz WLAN Low Pass Filter	CFL4111714505004K	L:2.0 ; W:1.25 ; T:0.85mm
1608 / 2.45GHz Bluetooth /WLAN Low Pass Filter	CFL4111715502454K	L:1.6 ; W:0.80 ; T:0.65mm
2012 / (2.45/5GHz) Dual Band/WLAN Diplexer (6pins)	CFL4111714802504K	L:2.0 ; W:1.25 ; T:0.75mm
2012 / (2.45/5GHz) Dual Band/WLAN Diplexer (6pins)	CFL4111714822504K	L:2.0 ; W:1.25 ; T:0.80mm
2012 / (2.45/5GHz) Dual Band/WLAN Diplexer (6pins)	CFL4111714832504K	L:2.0 ; W:1.25 ; T:0.85mm
2012 / (2.45/5GHz) Dual Band/WLAN Diplexer (8pins)	CFL4111714852504K	L:2.0 ; W:1.25 ; T:0.85mm
2012 / (2.45/5GHz) Dual Band/WLAN Diplexer (8pins)	CFL4111714862504K	L:2.0 ; W:1.25 ; T:0.85mm
2012 / (2.45/5GHz) Dual Band/WLAN Diplexer (6pins)	CFL4111714882504K	L:2.0 ; W:1.25 ; T:0.90mm

Surface-mount Ceramic Multilayer Balanced Filter (combo) / Balun Filter

Product Description	Part number	Dimension
2520 / 2.45 GHz Bluetooth /WLAN Balanced Filter (Combo)	CBA4711713912453K	L:2.5 ; W:2.0 ; T:1.20mm
2520 / 2.45 GHz Bluetooth /WLAN Balanced Filter (Combo)	CBA4711713932453K	L:2.5 ; W:2.0 ; T:1.15mm
2520 / 2.45 GHz Bluetooth /WLAN Balanced Filter (Combo)	CBA4711713952453K	L:2.5 ; W:2.0 ; T:1.20mm
2012 / 2.45 GHz Bluetooth /WLAN Balanced Filter (Combo)	CBA4711714952454K	L:2.0 ; W:1.25 ; T:0.9mm
2012 / 2.45 GHz Bluetooth /WLAN Balanced Filter (Combo)	CBA4711714982454K	L:2.0 ; W:1.25 ; T:0.9mm
2012 / 2.45 GHz Bluetooth /WLAN Balanced Filter (Combo)	CBA4711714882454K	L:2.0 ; W:1.25 ; T:0.9mm
2012 / 2.45 GHz Bluetooth /WLAN Balanced Filter (Combo)	CBA4711714972454K	L:2.0 ; W:1.25 ; T:0.9mm
2012 / 2.45 GHz Bluetooth /WLAN Balanced Filter (Combo)	CBA4711714772454K	L:2.0 ; W:1.25 ; T:0.9mm
2012 / 2.45 GHz Bluetooth /WLAN Balanced Filter (Combo)	CBA4711714672454K	L:2.0 ; W:1.25 ; T:0.9mm
2012 / 1.9GHz / PHS Balun (50-50 Ohm)	CBA4711714001904K	L:2.0 ; W:1.25 ; T:0.9mm
2012 / 1.9GHz / PHS Balun (50-100 Ohm)	CBA4711714011904K	L:2.0 ; W:1.25 ; T:0.9mm
2012 / 2.45GHz Bluetooth /WLAN Balun (50-50 Ohm)	CBA4711714002454K	L:2.0 ; W:1.25 ; T:0.9mm
2012 / 2.45GHz Bluetooth /WLAN Balun (50-100 Ohm)	CBA4711714012454K	L:2.0 ; W:1.25 ; T:0.9mm
2012 / 2.45GHz Bluetooth /WLAN Balun (50-200 Ohm)	CBA4711714022454K	L:2.0 ; W:1.25 ; T:0.9mm
2012 / 2.45GHz Bluetooth /WLAN Balun (50-50 Ohm)	CBA4711714052454K	L:2.0 ; W:1.25 ; T:0.9mm
2012 / 5GHz WLAN Balun (50-100 Ohm)	CBA4711714015004K	L:2.0 ; W:1.25 ; T:0.9mm
2012 / 3.1-4.8GHz UWB Balun (50-100 Ohm)	CBA4711714013484K	L:2.0 ; W:1.25 ; T:0.9mm
1608 / 5GHz WLAN Balun (50-100 Ohm)	CBA4711715015004K	L:1.6 ; W:0.8 ; T:0.6mm
1608 / 2.45GHz Bluetooth WLAN Balun (50-50 Ohm)	CBA4711715002454K	L:1.6 ; W:0.8 ; T:0.6mm
1608 / 3.5GHz Wimax Balun	CBA4711715003504K	L:1.6 ; W:0.8 ; T:0.6mm

Bluetooth / WLAN / Wimax Low Pass Filter (LPF)

1608 / 2.45GHz Bluetooth/WLAN Low Pass Filter
CFL4111715502454K

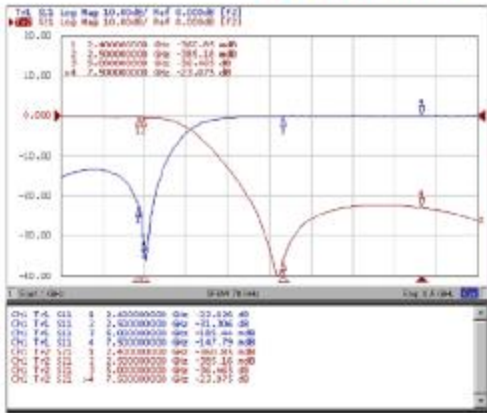

Description	Value
Frequency Range	2400-2500 MHz
Impedance	50 ohm
Insertion Loss	0.45dB (Max) at 25 °C
	0.75 dB(Max) at -40~ 85 °C
V.S.W.R.	1.5 (Max)
Ripple	0.6dB (Max)
Attenuation	25dB Min @ 5.0GHz
	18dB Min @ 7.5GHz
	18dB Min @ 10.0GHz
Dimension	1.8 x 0.8 x0.65 mm

2012 / 2.45GHz Bluetooth/WLAN Low Pass Filter
CFL4111714502454K

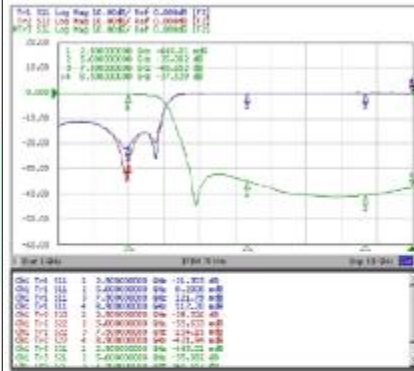

Description	Value
Frequency Range	2400-2500 MHz
Impedance	50 ohm
Insertion Loss	0.5dB (Max) at 25 °C
	0.8dB(Max) at -40 - +85 °C
V.S.W.R.	1.8 (Max)
Ripple	0.6dB
Attenuation	27dB Min @ 5.0GHz
	25dB Min @ 7.5GHz
	25dB Min @ 10.0GHz
Dimension	2.0 x 1.25 x0.85 mm

2012 / 3.5GHz Wimax Low Pass Filter
CFL4111714503504K



Description	Value
Frequency Range	3000-4000 MHz
Impedance	50 ohm
Insertion Loss	0.5dB (Max) at 25 °C
V.S.W.R.	2 (Max)
Attenuation	35dB Min @ 6.8GHz
	30dB Min @ 11GHz (ref)
Dimension	2.0 x 1.25 x0.85 mm

2012 / 5GHz WLAN Low Pass Filter
CFL4111 714505004K



Description	Value
Frequency Range	5150-5850 MHz
Impedance	50 ohm
Insertion Loss	1.8dB (Max) at 25°C
V.S.W.R.	2.0 (Max)
Ripple	0.5dB (Max)
Attenuation	30dB Min@2400-2500MHz
	20dBMin@ 4700MHz
Dimension	2.0 x 1.25 x 0.9 mm

Bluetooth / WLAN Band Pass Filter (BPF)

1608 / 2.45GHz Bluetooth /WLAN Band Pass Filter
CFL4111715012454K



Description	Value
Frequency Range	2400-2500 MHz
Impedance	50 Ohm
Insertion Loss	2.7dB (Max) at 25 °C 3.0dB (Max) at -40~85 °C
V.S.W.R.	2.0 (Max)
Ripple	0.5dB
Attenuation	30dB Min @ 880-960 MHz 30dB Min @ 1300-1600 MHz 20dB Min @ 1710-1910 MHz 30dB Min @ 4800-5000 MHz 30dB Min @ 7200-7500 MHz
Operating Temp.	-40~+85 °C
Dimension	1.6 x 0.8 x 0.65 mm

2012 / 2.45GHz Bluetooth/WLAN Band Pass Filter
CFL4111714032454K



Description	Value
Frequency Range	2400-2500 MHz
Insertion Loss	2.0dB (Max) 1.8dB (Typ) at 25 °C 2.3dB dB(Max) at -40~ 85 °C
V.S.W.R.	2.0 (Max)
Ripple	0.60dB
Attenuation	40dB Min @ 1000-1600MHz 40dB Min @ 4900MHz 20dB Min @ 7500MHz
Operating Temp.	-40 ~ +85 °C
Dimension	2.0 x 1.25 x 1.0 mm

1220 / 2.45GHz Bluetooth/WLAN Band Pass Filter
CFL4111714042454K

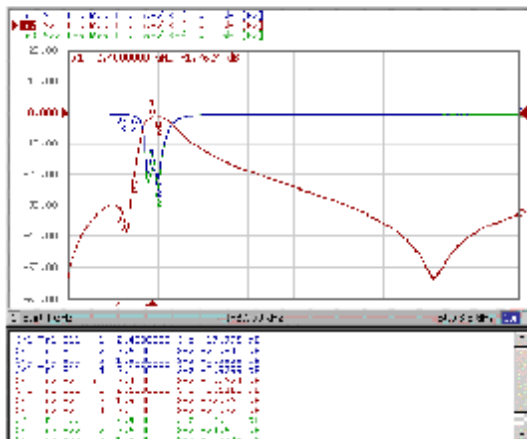

Description	Value
Frequency Range	2400-2500 MHz
Impedance	50 Ohm
Insertion Loss	2.0 dB (Max) at 25 °C 2.3 dB (Max) at -40~85 °C
V.S.W.R.	2.0 (Max)
Ripple	0.50 dB
Attenuation	30 dB Min @ 880-960MHz 30dB Min @ 1710-1910MHz 15 dB Min @ 2100 MHz 30 dB Min @ 4800-5000MHz 30 dB Min @ 7200-7500MHz
Operating Temperature	-40~+85 °C
Dimension	2.0 x 1.25 x 0.85 mm

2012 / 2.45GHz Bluetooth/WLAN Band Pass Filter
CFL4111714052454K

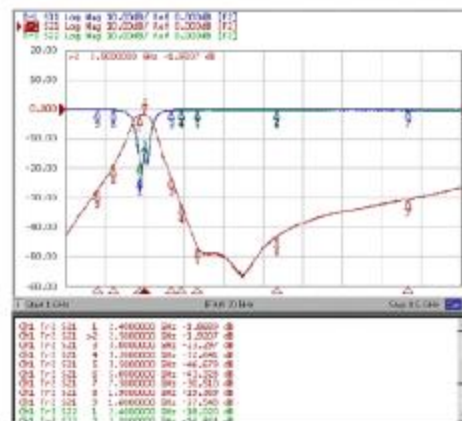

Description	Value
Frequency Range	2400-2500 MHz
Insertion Loss	2.0dB (Max) 1.8dB (Typ) at 25 °C 2.3dB dB(Max) at -40~ 85 °C
V.S.W.R.	2.0 (Max)
Ripple	0.50dB
Attenuation	24dB Min @ 3200MHz 30dB Min @ 4800-5000MHz 20dB Min @ 7200-7500MHz
Operating Temp.	-40 ~ +85 °C
Dimension	2.0 x 1.25 x 0.9 mm

1220 / 2.45GHz Bluetooth/WLAN Band Pass Filter
CFL4111714062454K

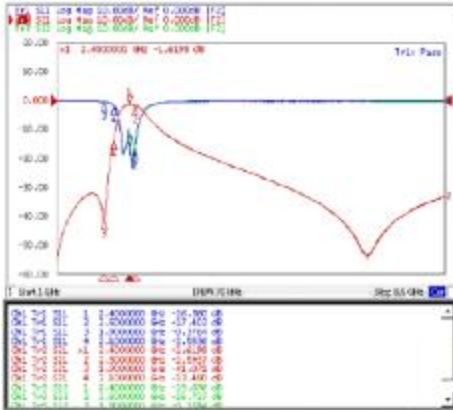

Description	Value
Frequency Range	2400-2500 MHz
Insertion Loss	1.8dB (Max) at 25°C
	2.1dB dB(Max) at -40~ 85 °C
V.S.W.R.	2.0 (Max)
Ripple	0.50dB
Attenuation	30dB Min @ 880~960MHz
	30dB Min @ 1710~1910MHz
	25dB Min @ 4800~5000MHz
	30dB Min @ 7200~7500MHz
Operating Temp.	-40 ~ +85 °C
Dimension	2.0 x 1.25 x 0.85 mm

1220 / 2.45GHz Bluetooth/WLAN Band Pass Filter
CFL4111714182454K

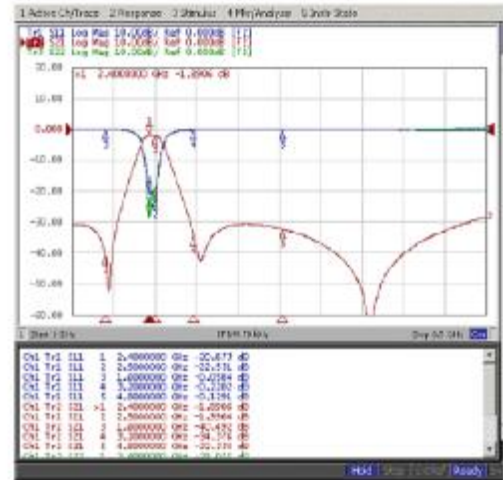

Description	Value
Frequency Range	2400-2500 MHz
Insertion Loss	2.2dB (Max) at 25°C
	2.5dB dB(Max) at -40~ 85 °C
V.S.W.R.	2.0 (Max)
Ripple	0.50dB
Attenuation	30dB Min @ 1600MHz
	30dB Min @ 3200MHz
	30dB Min @ 4800MHz
	30dB Min @ 7200MHz
Operating Temp.	-40 ~ +85 °C
Dimension	2.0 x 1.25 x 1.1 mm

1202 / 2.45GHz Bluetooth/WLAN Band Pass Filter
CFL4111714192454K

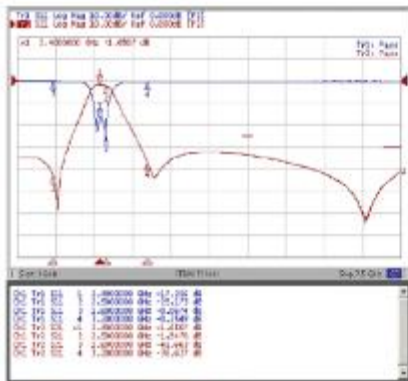

Description	Value
Frequency Range	2400-2500 MHz
Insertion Loss	2.5dB (Max) at 25°C
	2.8dB dB(Max) at -40~ 85 °C
V.S.W.R.	2.0 (Max)
Ripple	0.50dB
Attenuation	30dB Min @1600MHz
	30dB Min @3200MHz
	20dB Min @ 4800MHz
	25dB Min @ 7200MHz
Operating Temp.	-40 ~ +85 °C
Dimension	2.0 x 1.25 x 0.9 mm

1202 / 2.45GHz Bluetooth/WLAN Band Pass Filter
CFL4111714992454K

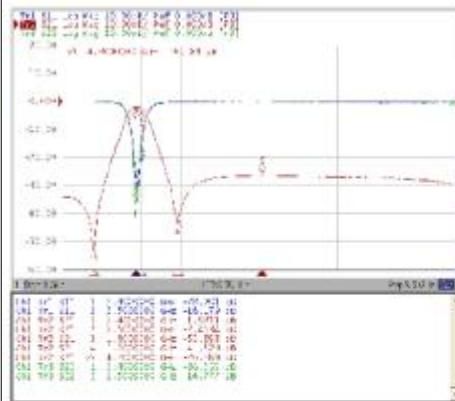

Description	Value
Frequency Range	2400-2500 MHz
Impedance	50 Ohm
Insertion Loss	2.8dB (Max) at 25°C
	3.0dB (Max) at -40~85°C
V.S.W.R.	2.0 Max
Ripple	0.50dB
Attenuation	40dB Min @ 1600 MHz
	38dB Min @ 3200 MHz
	20dB Min @ 4800 MHz
	25dB Min @ 7200 MHz
Operating Temp.	-40~+85°C
Dimension	2.1 x 1.25 x 0.9 mm

2012 / 5.0 GHz WLAN Band Pass Filter
CFL4111714015004K

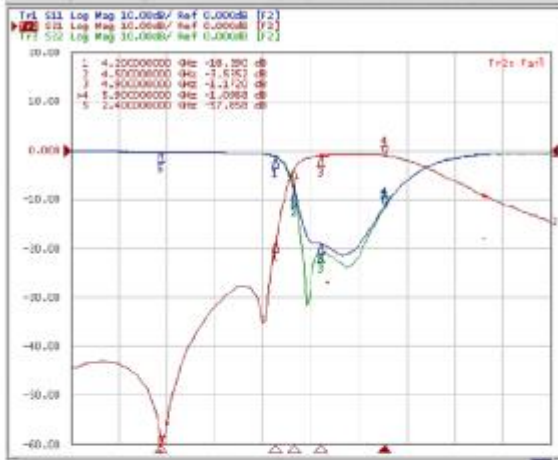

Description	Value
Frequency Range	4900~5950 MHz
Impedance	50 Ohm
Insertion Loss	1.5 dB (Max) at 25 °C
	1.8 dB (Max) at -40~85 °C
V.S.W.R	2.0 Max
Ripple	0.6dB (Max)
Attenuation	30 dB Min @ 1280~3000 MHz
	25 dB Min @ 3300~4000 MHz
	25 dB Min @ 9800~11900 MHz
Operating Temp.	-40~+85 °C
Dimension	2.0 x 1.25 x 1.0 mm

2012 / 5.0 GHz WLAN Band Pass Filter
CFL4111714035004K

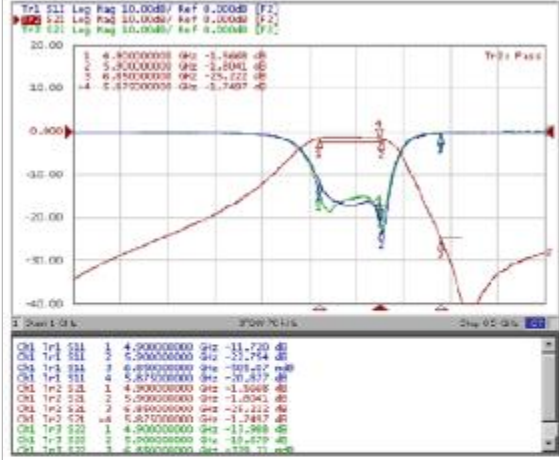

Description	Value
Frequency Range	4900~5900 MHz
Impedance	50 Ohm
Insertion Loss	2.2 dB (Max) at 25 °C
V.S.W.R	2.0 Max
Ripple	0.6dB
Attenuation	25 dB Min @ 6850~7150 MHz
	20 dB Min @ 7500~9000 MHz
Operating Temp.	-40~+85 °C
Dimension	2.0 x 1.25 x 0.85 mm

1220 / 5.0 GHz WLAN Band Pass Filter
CFL4111714055004K

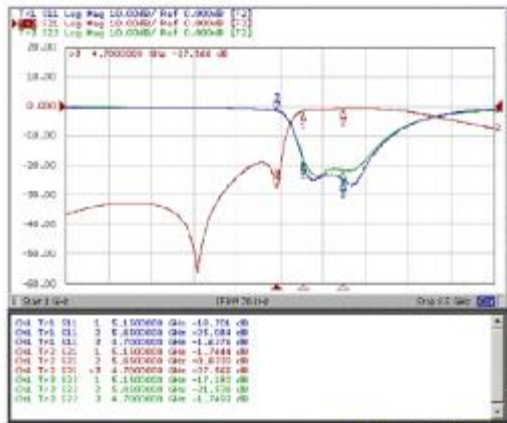

Description	Value
Frequency Range	5150~5850 MHz
Impedance	50 Ohm
Insertion Loss	1.8 dB (Max) at 25 °C
	2.1 dB (Max) at -40~85 °C
V.S.W.R	2.0 Max
Ripple	0.50 dB
Attenuation	30 dB Min @ 2400~2500 MHz
	25 dB Min @ 4700 MHz
Operating Temp.	-40~+85 °C
Dimension	2.0 x 1.25 x 0.9 mm

2520 / 2.45GHz Bluetooth/WLAN Band Pass Filter
CFL4111713032453K

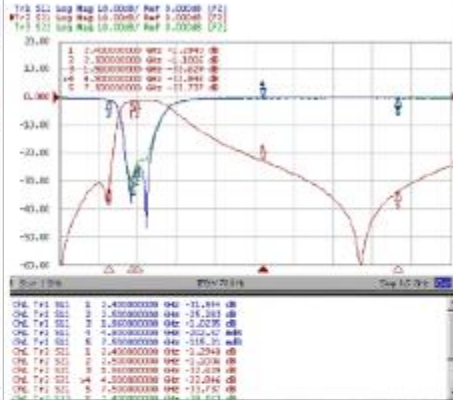

Description	Value
Frequency Range	2400-2500 MHz
Impedance	50 ohm
Return Loss	10 dB (Min.)
Insertion Loss	1.5dB (Max.), 1.3dB (Typ)at 25 °C
	1.8 dB(max) at-40 ~ +85 °C
V.S.W.R	2.0 (Max.)
Ripple	0.6 dB (max)
Attenuation	40dB Min @ 800~900MHz
	30dB Min @ 1710~1785MHz
	30dB Min @ 1850~1910MHz
	20dB Min @ 4800~5000MHz
	30dB Min @ 7200~7500MHz
Dimension	2.5 x 2.0 x 0.95 mm

2520 / 2.45GHz Bluetooth/WLAN Band Pass Filter
CFL4111713052453K

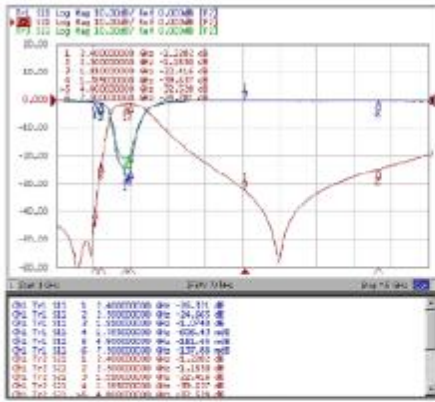

Description	Value
Frequency Range	2400-2500 MHz
Impedance	50 ohm
Return Loss	10 dB(Min.)
Insertion Loss	1.5dB (Max.), 1.3dB (Typ)at 25 °C
	1.8 dB(Max.) at-40 ~ +85 °C
V.S.W.R.	2.0 (Max.)
Ripple	0.6 dB (max)
Attenuation	40dB Min @ 880-960MHz
	30dB Min @ 1710-1785MHz
	20dB Min @ 1850-1910MHz
	30dB Min @ 4800-5000MHz
	20dB Min @ 7200-7500MHz
Dimension	2.5 x 2.0 x 1.1 mm

2520 / 2.45GHz Bluetooth/WLAN Band Pass Filter
CFL4111713072453K



Description	Value
Frequency Range	2400-2500 MHz
Impedance	50 ohm
Return Loss	10 dB(Min.)
Insertion Loss	2.5dB (Max.), 2.2dB (Typ.)
V.S.W.R.	2.0 (Max.)
Attenuation	20dB Min @ 880-960MHz
	20dB Min @ 2700MHz
	25dB Min @ 4800-5000MHz
	25dB Min @ 7200-7500MHz
Dimension	2.5 x 2.0 x 1.2 mm

2520 / 2.45GHz Bluetooth/WLAN Band Pass Filter
CFL4111713182453K

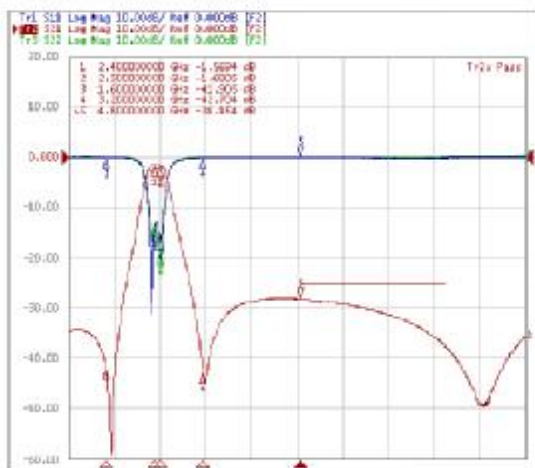

Description	Value
Frequency Range	2400-2500 MHz
Impedance	50 ohm
Return Loss	10 dB(Min.)
Insertion Loss	2.2 dB (Max.), 2.0dB (Typ)
V.S.W.R.	2.0 (Max.)
Attenuation	30dB Min @ 1600MHz
	35dB Min @ 3200MHz
	25dB Min @ 4800-5000MHz
	30dB Min @ 7200-7500MHz
Dimension	2.5 x 2.0 x 0.95 mm

2.45 & 5 GHz WLAN Diplexer (LPF + HPF)

2012 / 2.45 & 5GHz WLAN Diplexer (LPF+HPF)
CFL4111 714 80 2504K

2012 / 2.45 & 5GHz WLAN Diplexer (LPF+HPF)
CFL4111 714 86 2504K

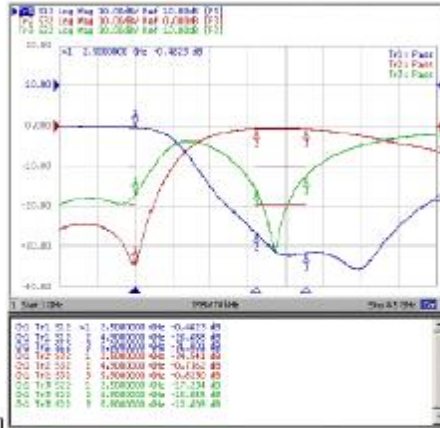
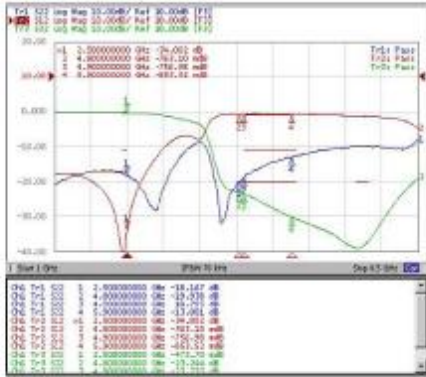

Description	Value	
Frequency Range	Low Band (2400~2500 MHz)	High Band (4900~5900 MHz)
Insertion Loss	0.6 dB (Max)	0.8 dB (Typical)
V.S.W.R./Return-Loss	2.0 Max.	2.0 Max
Attenuation	18 dB Min @ 4800~6000 MHz	18 dB Min @ 1800~2500 MHz
	20 dB Min @ 7200~7500 MHz	15 dB Min @ 10300~10700 MHz
Isolation	18 dB (Min)	18 dB (Min)
Operating Temp.	-40~+85 °C	-40~+85 °C
Dimension	2.0 x 1.25 x 0.75 mm	

Description	Value	
Frequency Range	2400~2500 MHz	4900~5900 MHz
Insertion Loss	0.6dB (Max)	0.9dB (Max)
V.S.W.R.	2.0 (Max)	2.0(Max)
Attenuation	20dB min.@4900-5900MHz	25dB min.@2400-2500MHz
Operating Temperature	-40 ~ +85 °C	
Dimension	2.0 x 1.25 x 0.85 mm	

2012 / 2.45 & 5GHz WLAN Diplexer (LPF+BPF)
CFL4111 714 88 2504K



Description	Value	
Frequency Range	2400~2500 MHz	4900~5900 MHz
Insertion Loss	0.5dB (Max)	0.9dB (Max)
V.S.W.R.	2.0 (Max)	2.0(Max)
Attenuation	20.0dB min.@4800~6000MHz	25 dB min.@1800~2500MHz
	20.0dB min @7200~7500MHz	25 dB min.@9800~11800MHz
Operating Temperature	-40 ~ +85 °C	
Dimension	2.0 x 1.25 x 0.9mm	

Innovative Services Around the Globe **YAGEO**

2.45 GHz Bluetooth / WLAN Balanced Filter (Combo)

2012 / 2.45GHz Bluetooth/WLAN Balanced Filter
CBA4711 713 67 2453K

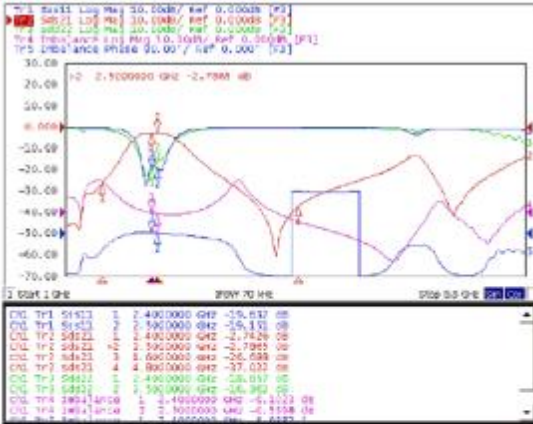

Description	Value
Frequency Range	2400-2500 MHz
Unbalanced Impedance	50 Ohm
Balanced Impedance	Conjugate match to CSR BC 04 series
Unbalanced port V.S.W.R.	2.0 (Max)
Balanced port V.S.W.R.	2.0 (Max)
Insertion Loss	3.0 dB (Typ) at 25 °C
	3.5 dB (Max) at 25 °C
Ripple	3.8 dB (Max) at -40-85 °C
	1.0 dB (Max)
Amplitude Balance	1.0 dB (Max) at 25 °C
	1.4 dB (Max) at -40-85 °C
Phase Differential	180 ± 5 degree at 25 °C
	180 ± 10 degree at -40-85 °C
Attenuation	40 dB Min @ 880-960 MHz
	25 dB Min @ 1300-1600 MHz
	30 dB Min @ 4800-5000 MHz
	25 dB Min @ 7200-7500 MHz
Dimension	2.0 x 1.25 x 0.9 mm
DC Working Voltage	0-25 Volt

2012 / 2.45GHz Bluetooth/WLAN Balanced Filter
CBA4711 714 77 2454K

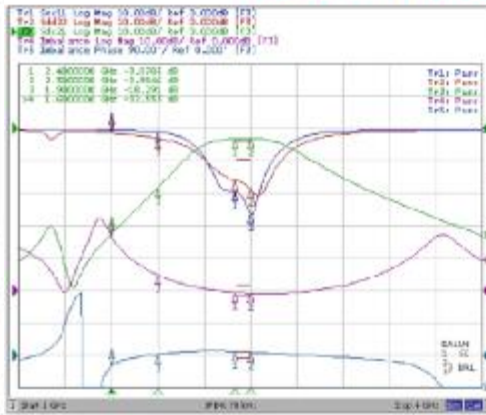

Description	Value
Frequency Range	2400-2500 MHz
Unbalanced Impedance	50 Ohm
Balanced Impedance	Conjugate match to CSR BC 04 series
Unbalanced port V.S.W.R.	2.0 (Max)
Balanced port V.S.W.R.	2.0 (Max)
Insertion Loss	3.0 dB (Typ) at 25 °C
	3.5 dB (Max) at 25 °C
Ripple	3.8 dB (Max) at -40-85 °C
	1.0 dB (Max)
Amplitude Balance	1.0 dB (Max) at 25 °C
	1.4 dB (Max) at -40-85 °C
Phase Differential	180 ± 5 degree at 25 °C
	180 ± 10 degree at -40-85 °C
Attenuation	40 dB Min @ 880-960 MHz
	20 dB Min @ 1300-1600 MHz
	35 dB Min @ 4800-5000 MHz
	25 dB Min @ 7200-7500 MHz
Dimension	2.0 x 1.25 x 0.9 mm



2012 / 2.45GHz Bluetooth/WLAN Balanced Filter
CBA4711 714 88 2454K



Description	Value
Frequency Range	2400-2500 MHz
Unbalanced Imp.	50 Ohm
Balanced Imp.	Conjugate match to CSR BC03/04
Insertion Loss	3.5 dB (Max) at 25 Deg. C
	3.8 dB (Max) at -40 - +85 Deg. C
Unbalanced port V.S.W.R.	2.0 (Max)
Ripple	1.0 dB (Max)
Amplitude Bal.	1.0 dB (Max)
Phase Differential	180 ± 5 degree
Attenuation	40 dB (Min) @ 880 - 960MHz
	25 dB (Min) @1300-1600MHz
	35 dB (Min) @4800-5000Hz
	30 dB (Min) @7200-7500MHz
Dimension , Color	2.0 x 1.25 x 0.9 mm , White

2012 / 2.45GHz Bluetooth/WLAN Balanced Filter
CBA4711 714 98 2454K

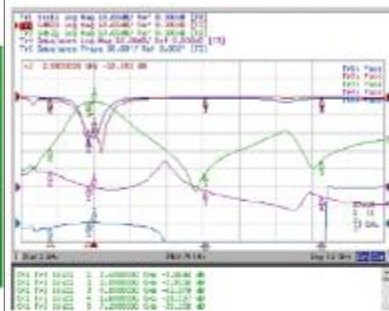

Description	Value
Frequency Range	2400-2500 MHz
Unbalanced Imp.	50 Ohm
Balanced Imp.	Conjugate match to CSR BC03/04
Insertion Loss	3.5 dB (Max) at 25 Deg. C
	3.8 dB (Max) at -40 - +85 Deg. C
Unbalanced port V.S.W.R.	2.0 (Max)
Ripple	1.0 dB (Max)
Amplitude Bal.	1.0 dB (Max)
Phase Differential	180 ± 5 degree
Attenuation	40 dB (Min) @ 880 - 960MHz
	25 dB (Min) @1300-1600MHz
	35 dB (Min) @4800-5000Hz
	30 dB (Min) @7200-7500MHz
Dimension	2.0 x 1.25 x 0.9 mm



2520 / 2.45GHz Bluetooth/WLAN Balanced Filter
CBA4711 713 93 2453K

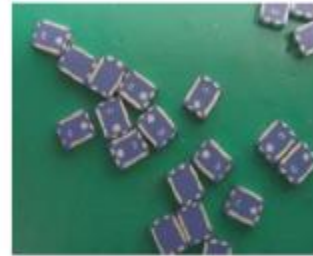

Description	Value
Frequency Range	2400-2500 MHz
Unbalanced	50 Ohm
Balanced Impedance	Conjugate match to CSR
Insertion Loss	3.0 dB (Max) at 25 Deg. C
	3.3 dB (Max) at -40 ~ +85 Deg. C
Unbalanced port V.S.W.R.	2.0 (Max)
Ripple	0.5 dB (Max)
Amplitude Balance	1.0 dB (Max)
Phase Differential	180 ± 8 degree
Attenuation	48 dB (Min) @ 880~ 960MHz
	22 dB (Min) @ 1710~1910MHz
	20 dB (Min) @ 5.0GHz
	30 dB (Min) @ 7.5GHz
Dimension	2.5 x 2.0 x 1.2 mm

Bluetooth / WLAN Balun

1608 / 5.2GHz WLAN Balun
CBA4711 715 01 5004K

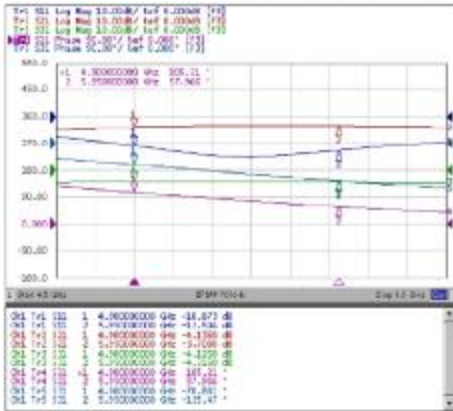

Description	Value
Frequency Range	4600-5950 MHz
Unbalanced Impedance	50 Ohm
Balanced Impedance	100 Ohm
Return Loss	10dB (Min)
Insertion Loss	1.2 dB (Max) at 25 Deg. C
	1.5 dB (Max) at -40 ~ +65 Deg. C
Unbalanced port V.S.W.R	2.0 (Max)
Phase Difference	180 ±10 degree
Amplitude Difference	1.5 dB (Max)
Dimension	1.6 x 0.8 x 0.65 mm

2012 / 2.45GHz Bluetooth/WLAN Balun
CBA4711 714 00 2454K



Description	Value
Frequency Range	2400-2500 MHz
Unbalanced Impedance	50 Ohm
Balanced Impedance	50 Ohm 100Ohm 200Ohm
Return Loss	10dB (Min)
Insertion Loss	1 dB (Max) at 25 Deg. C
	1.3 dB (Max) at -40 ~ +65 Deg. C
Unbalanced port V.S.W.R	2.0 (Max)
Ripple	0.6dB
Phase Difference	180 ±10 degree
Amplitude Difference	2.0 dB (Max)
Dimension	2.0 x 1.25 x 0.8 mm

2012 / 3.5GHz UWB Balun
CBA4711 714 01 3484K

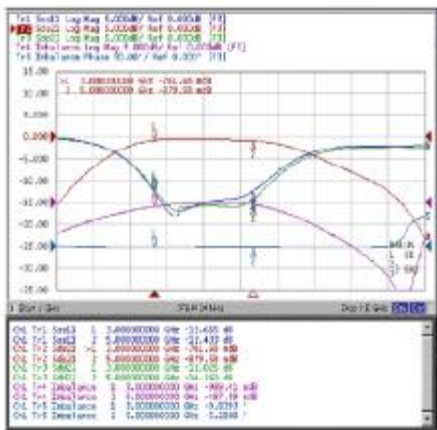

Description	Value
Frequency Range	3100-4800 MHz
Unbalanced Impedance	50 Ohm
Balanced Impedance	100 Ohm
Return Loss	10 dB (Min)
Insertion Loss	1.2 dB (Max) at 25 °C
	1.5 dB (Max) at -40~+85 °C
Phase Difference	180 ± 10 degree
Amplitude Difference	1.5 dB (Max)
Dimension	2.0 x 1.25 x 0.95 mm

2012 / 5GHz WLAN Balun
CBA4711 714 01 5004K

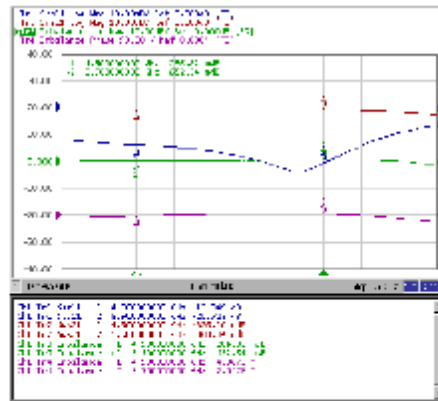

Description	Value
Frequency Range	4900-6000 MHz
Unbalanced Impedance	50 Ohm
Balanced Impedance	100 Ohm
Insertion Loss	1.2 dB (Max) at 25 Deg. C
	1.4 dB (Max) at -40 ~ +85 Deg. C
Return Loss	10dB (Min)
Unbalanced port V.S.W.R	2.0 (Max)
Ripple	0.6dB
Phase Difference	180 ±10 degree
Amplitude Difference	2.0 dB (Max)
Dimension	2.0 x 1.25 x 0.8 mm



© WH

Innovative Services Around the Globe **YAGEO**



element14

EN - For pricing and availability in your local country please visit one of the below links:

DE - Informationen zu Preisen und Verfügbarkeit in Ihrem Land erhalten Sie über die unten aufgeführten Links:

FR - Pour connaître les tarifs et la disponibilité dans votre pays, cliquez sur l'un des liens suivants:

[CAN4311129200431K](#)

EN

This Datasheet is presented by
the manufacturer

DE

Dieses Datenblatt wird vom
Hersteller bereitgestellt

FR

Cette fiche technique est
présentée par le fabricant

单击下面可查看定价，库存，交付和生命周期等信息

[>>Yageo\(国巨\)](#)