



LUXEON 2835 Line

Perfected performance, built on a proven legacy

LUXEON 2835 Line is a collection of compact devices that allows for design freedom and provides a superior overall system solution when a project requires high lumen output and good efficacy. With an industry standard footprint, the LUXEON 2835 Line is the perfect upgrade for other 2835 products and other common mid power offerings. The LUXEON 2835 Line is color targeted for application needs and delivers efficacy and reliability for a variety of applications. It is available in three product offerings, LUXEON 2835C for higher output, LUXEON 2835E for lower output, and LUXEON 2835 HE for high efficacy ranges.



FEATURES AND BENEFITS

Various configurations of voltage and die count to meet a wide range of application requirements

Industry standard footprint for drop-in replacement designs

Maximum drive current of up to 480mA allows for reduction of LED count

6V and 9V hot-color targeting and 1/9th micro-color binning enable tight color control

2-, 3-, 4- and 5-step MacAdam ellipse color kits available

PRIMARY APPLICATIONS

Downlights

High Bay & Low Bay

Indoor Area Lighting

- TLEDs

- Troffers

Lamps

Table of Contents

General Product Information	2
Product Test Conditions	2
Part Number Nomenclature	2
Lumen Maintenance	2
Environmental Compliance	2
Performance Characteristics	3
Product Selection Guide	3
Optical Characteristics	5
Electrical and Thermal Characteristics	5
Absolute Maximum Ratings	5
Characteristics Curves	6
Spectral Power Distribution Characteristics	6
Light Output Characteristics	8
Forward Current Characteristics	10
Radiation Pattern Characteristics	11
Product Bin and Labeling Definitions	12
Decoding Product Bin Labeling	12
Luminous Flux Bins	13
Color Bin Definition	14
Forward Voltage Bins	26
Mechanical Dimensions	27
Reflow Soldering Guidelines	28
JEDEC Moisture Sensitivity	28
Solder Pad Design	29
Packaging Information	29
Pocket Tape Dimensions	29
Reel Dimensions	30

General Product Information

Product Test Conditions

LUXEON 2835 LEDs are tested with a 20ms monopulse specified below at a junction temperature, T_j , of 25°C. Forward voltage and luminous flux are binned at a T_j of 25°C. LUXEON 2835E 6V, LUXEON 2835E 9V and LUXEON 2835C 6V color is hot-targeted at a T_j of 85°C and LUXEON 2835 HE 3V, LUXEON 2835E 3V, LUXEON 2835C 3V and LUXEON 2835C 3V TVS color is cold-targeted at a T_j of 25°C.

- 60mA – LUXEON 2835E
- 65mA – LUXEON 2835 HE
- 120mA – LUXEON 2835C

Part Number Nomenclature

Part numbers for LUXEON 2835 Line follow the convention below:

L 1 2 8 – **A A B B C D** 3 5 0 0 0 **E F**

Where:

- A A** – designates nominal ANSI CCT (27=2700K, 30=3000K, 35=3500K, 40=4000K, 50=5000K, 57=5700K, 65=6500K)
- B B** – designates minimum CRI (80=80CRI and 90=90CRI)
- C** – designates binning current (C=120mA, and E=60mA and H=65mA)
- D** – designates voltage of the part (A=3V, B=6V and C=9V)
- E** – designates Lumileds internal code (T=TVS included)
- F** – designates Lumileds internal code (1, 2, 3, etc.=shares the same base part)

Therefore, the following part number is used for a LUXEON 2835C 3000K 80CRI, 6V:

L 1 2 8 – **3 0 8 0 C B** 3 5 0 0 0 0 **1**

Lumen Maintenance

Please contact your local Sales Representative or Lumileds Technical Solutions Manager for more information about the long-term performance of this product.

Environmental Compliance

Lumileds LLC is committed to providing environmentally friendly products to the solid-state lighting market. LUXEON 2835 Line is compliant to the European Union directives on the restriction of hazardous substances in electronic equipment, namely the RoHS Directive 2011/65/EU and REACH Regulation (EC) 1907/2006. Lumileds LLC will not intentionally add the following restricted materials to its products: lead, mercury, cadmium, hexavalent chromium, polybrominated biphenyls (PBB) or polybrominated diphenyl ethers (PBDE).

Performance Characteristics

Product Selection Guide

Table 1. Product performance of LUXEON 2835 Line at specified test conditions.

PRODUCT	VOLTAGE	NOMINAL CCT ^[1]	MINIMUM CRI ^[2, 3]	LUMINOUS FLUX ^[2, 3] (lm)		TYPICAL LUMINOUS EFFICACY (lm/W)	TEST CURRENT (mA)	PART NUMBER
				MINIMUM	TYPICAL			
LUXEON 2835E	9V	6500K	70	78	86	158	60	L128-6570EC3500001
		2200K	80	59	65	119	60	L128-2280EC3500001
		2700K	80	67	75	137	60	L128-2780EC3500001
		3000K	80	70	78	142	60	L128-3080EC3500001
		3500K	80	72	80	147	60	L128-3580EC3500001
		4000K	80	74	82	150	60	L128-4080EC3500001
		5000K	80	74	82	150	60	L128-5080EC3500001
		5700K	80	74	82	150	60	L128-5780EC3500001
		6500K	80	74	82	150	60	L128-6580EC3500001
		2200K	90	50	55	102	60	L128-2290EC3500001
		2700K	90	54	62	114	60	L128-2790EC3500001
		3000K	90	57	65	119	60	L128-3090EC3500001
		3500K	90	60	68	124	60	L128-3590EC3500001
		4000K	90	62	70	128	60	L128-4090EC3500001
		5000K	90	62	70	128	60	L128-5090EC3500001
	2700K	80	45	50	139	60	L128-2780EB3500001	
	3000K	80	46	51	142	60	L128-3080EB3500001	
	3500K	80	47	52	144	60	L128-3580EB3500001	
	4000K	80	49	54	150	60	L128-4080EB3500001	
	5000K	80	49	54	150	60	L128-5080EB3500001	
	5700K	80	49	54	150	60	L128-5780EB3500001	
	6500K	80	49	54	150	60	L128-6580EB3500001	
	2700K	80	23	25	137	60	L128-2780EA3500001	
	3000K	80	24	27	148	60	L128-3080EA3500001	
	3500K	80	24	28	154	60	L128-3580EA3500001	
	4000K	80	26	29	159	60	L128-4080EA3500001	
	5000K	80	26	29	159	60	L128-5080EA3500001	
	5700K	80	26	29	159	60	L128-5780EA3500001	
	6500K	80	26	29	159	60	L128-6580EA3500001	
	2700K	90	19	22	129	60	L128-2790EA3500001	
3000K	90	20	22	129	60	L128-3090EA3500001		
3500K	90	20	23	135	60	L128-3590EA3500001		
4000K	90	21	24	140	60	L128-4090EA3500001		
5000K	90	21	24	140	60	L128-5090EA3500001		
5700K	90	21	25	146	60	L128-5790EA3500001		
6500K	90	21	25	146	60	L128-6590EA3500001		

Table 1 continued on next page.

1. Correlated color temperature is cold-targeted at T_j=25°C for 3V products (LUXEON 2835E 3V, LUXEON 2835C 3V, and LUXEON 2835C 3V TVS). Correlated color temperature is hot-targeted at T_j=85°C for 6V and 9V products (LUXEON 2835E 6V, LUXEON 2835E 9V, and LUXEON 2835C 6V).
2. Luminous flux and CRI specs are based upon mounted package on highly reflective surface at T_j=25°C. Typical CRI is approximately 2 points higher than the minimum CRI specified, but this is not guaranteed.
3. Lumileds maintains a tolerance of ±2 on CRI and ±7.5% on luminous flux measurements.

Table 1. Product performance of LUXEON 2835 Line at specified test conditions (continued).

PRODUCT	VOLTAGE	NOMINAL CCT ^[1]	MINIMUM CRI ^[2, 3]	LUMINOUS FLUX ^[2, 3] (lm)		TYPICAL LUMINOUS EFFICACY (lm/W)	TEST CURRENT (mA)	PART NUMBER	
				MINIMUM	TYPICAL				
LUXEON 2835C	6V	2700K	80	93	105	141	120	L128-2780CB3500001	
		3000K	80	96	108	145	120	L128-3080CB3500001	
		3500K	80	99	111	149	120	L128-3580CB3500001	
		4000K	80	103	115	155	120	L128-4080CB3500001	
		5000K	80	103	115	155	120	L128-5080CB3500001	
		5700K	80	103	115	155	120	L128-5780CB3500001	
		6500K	80	103	115	155	120	L128-6580CB3500001	
		2700K	90	78	88	120	120	L128-2790CB3500001	
		3000K	90	81	91	124	120	L128-3090CB3500001	
		3500K	90	83	93	127	120	L128-3590CB3500001	
		4000K	90	87	97	133	120	L128-4090CB3500001	
		5000K	90	87	97	133	120	L128-5090CB3500001	
		2700K	80	49	54	154	120	L128-2780CA3500001	
		3000K	80	51	56	160	120	L128-3080CA3500001	
		3500K	80	53	57	164	120	L128-3580CA3500001	
	4000K	80	55	60	168	120	L128-4080CA3500001		
	5000K	80	55	60	168	120	L128-5080CA3500001		
	5700K	80	55	60	168	120	L128-5780CA3500001		
	6500K	80	55	60	168	120	L128-6580CA3500001		
	3V	2700K	90	42	47	132	120	L128-2790CA3500001	
		3000K	90	42	48	134	120	L128-3090CA3500001	
		3500K	90	44	50	139	120	L128-3590CA3500001	
		4000K	90	46	51	143	120	L128-4090CA3500001	
		5000K	90	46	51	143	120	L128-5090CA3500001	
		5700K	90	46	52	145	120	L128-5790CA3500001	
		6500K	90	46	52	145	120	L128-6590CA3500001	
		3V TVS	2700K	80	48	54	149	120	L128-2780CA35000T1
			3000K	80	50	56	154	120	L128-3080CA35000T1
			3500K	80	52	57	158	120	L128-3580CA35000T1
			4000K	80	54	58	163	120	L128-4080CA35000T1
5000K			80	54	58	163	120	L128-5080CA35000T1	
5700K			80	54	58	163	120	L128-5780CA35000T1	
6500K		80	54	58	163	120	L128-6580CA35000T1		
LUXEON 2835 HE		3V	2700K	80	30.0	31.7	180.0	65	L128-2780HA3500001
	3000K		80	31.5	33.0	187.3	65	L128-3080HA3500001	
	3500K		80	32.8	34.5	195.9	65	L128-3580HA3500001	
	4000K		80	33.7	35.5	201.5	65	L128-4080HA3500001	
	5000K		80	33.7	35.5	201.5	65	L128-5080HA3500001	
	5700K		80	33.7	35.5	201.5	65	L128-5780HA3500001	
	6500K		80	33.3	35.0	201.5	65	L128-6580HA3500001	

Notes for Table 1:

1. Correlated color temperature is cold-targeted at T_j=25°C for 3V products (LUXEON 2835 HE, LUXEON 2835E 3V, LUXEON 2835C 3V, and LUXEON 2835C 3V TVS). Correlated color temperature is hot-targeted at T_j=85°C for 6V and 9V products (LUXEON 2835E 6V, LUXEON 2835E 9V, and LUXEON 2835C 6V).
2. Luminous flux and CRI specs are based upon mounted package on highly reflective surface at T_j=25°C. Typical CRI is approximately 2 points higher than the minimum CRI specified, but this is not guaranteed.
3. Lumileds maintains a tolerance of ±2 on CRI and ±7.5% on luminous flux measurements.

Optical Characteristics

Table 2. Optical characteristics for LUXEON 2835 Line at test current, $T_j=25^\circ\text{C}$.

PART NUMBER	TYPICAL TOTAL INCLUDED ANGLE ^[1]	TYPICAL VIEWING ANGLE ^[2]
L128-xxxxx35000x1	160°	120°

Notes for Table 2:

- Total angle at which 90% of total luminous flux is captured.
- Viewing angle is the off axis angle from the LED centerline where the luminous intensity is ½ of the peak value.

Electrical and Thermal Characteristics

Table 3. Electrical and thermal characteristics for LUXEON 2835 Line at test current, $T_j=25^\circ\text{C}$.

PART NUMBER	FORWARD VOLTAGE ^[1] (V_f)			TYPICAL TEMPERATURE COEFFICIENT OF FORWARD VOLTAGE ^[2] (mV/°C)	TYPICAL THERMAL RESISTANCE—JUNCTION TO SOLDER PAD (°C/W)
	MINIMUM	TYPICAL	MAXIMUM		
L128-xxxxEC3500001	8.7	9.1	9.9	-3.0 to -6.0	15
L128-xxxxEB3500001	5.8	6.1	6.6	-2.0 to -4.0	20
L128-xxxxEA3500001	2.7	2.9	3.1	-1.0 to -2.0	39
L128-xxxxCB3500001	5.8	6.1	6.6	-2.0 to -4.0	11
L128-xxxxCA35000x1	2.9	3.0	3.2	-1.0 to -2.0	21
L128-xxxxHA35000x1	2.54	2.71	2.78	-1.0 to -2.0	13

Notes for Table 3:

- Lumileds maintains a tolerance of $\pm 0.1\text{V}$ on forward voltage measurements.
- Measured between 25°C and 85°C .

Absolute Maximum Ratings

Table 4. Absolute maximum ratings for LUXEON 2835 Line.

PARAMETER	MAXIMUM PERFORMANCE
DC Forward Current ^[1,2]	150mA for L128-xxxxEC3500001 150mA for L128-xxxxEB3500001 150mA for L128-xxxxEA3500001 240mA for L128-xxxxCx3500001 480mA for L128-xxxxHA3500001
Peak Pulsed Forward Current ^[1,3]	200mA for L128-xxxxEx3500001 300mA for L128-xxxxCx35000x1
LED Junction Temperature ^[1] (DC & Pulse)	125°C for L128-xxxxEC3500001 125°C for L128-xxxxEB3500001 115°C for L128-xxxxEA3500001 125°C for L128-xxxxCx3500001 125°C for L128-xxxxHA3500001
ESD Sensitivity (ANSI/ESDA/JEDEC JS-001-2012)	Class 3B for LUXEON 2835C 3V TVS with ESD protection Class 2 for all other LUXEON 2835 parts
Operating Case Temperature ^[1]	-40°C to 105°C
LED Storage Temperature	-40°C to 105°C
Soldering Temperature	JEDEC 020c 260°C
Allowable Reflow Cycles	3
Reverse Voltage ^[4,5] (V_{reverse})	5

Notes for Table 4:

- Proper current derating must be observed to maintain the junction temperature below the maximum allowable junction temperature.
- Residual periodic variations due to power conversion from alternating current (AC) to direct current (DC), also called "ripple," are acceptable if the following conditions are met:
 - The frequency of the ripple current is 100Hz or higher
 - The average current for each cycle does not exceed the maximum allowable DC forward current
 - The maximum amplitude of the ripple does not exceed the maximum peak pulsed forward current
- At $\leq 50\%$ duty cycle with pulse width of 5ms.
- Transient reverse voltages and surge currents due to electrical switching or supply interruptions are acceptable if these events do not last for more than 10ms, the amplitude of the reverse voltage does not exceed 5V and the reverse current is less than 220uA.
- Max 5V reverse for up to 10s is an acceptable beginning of life, one time test condition.

Characteristics Curves

Spectral Power Distribution Characteristics

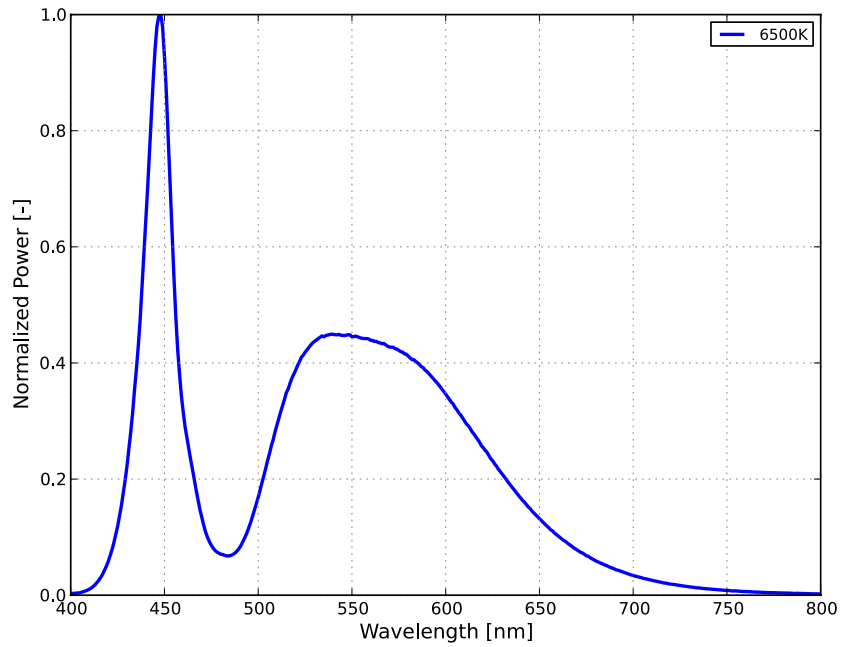

Figure 1a. Typical normalized power vs. wavelength for 70CRI LUXEON 2835E and LUXEON 2835C at test current, $T_j=25^{\circ}\text{C}$.

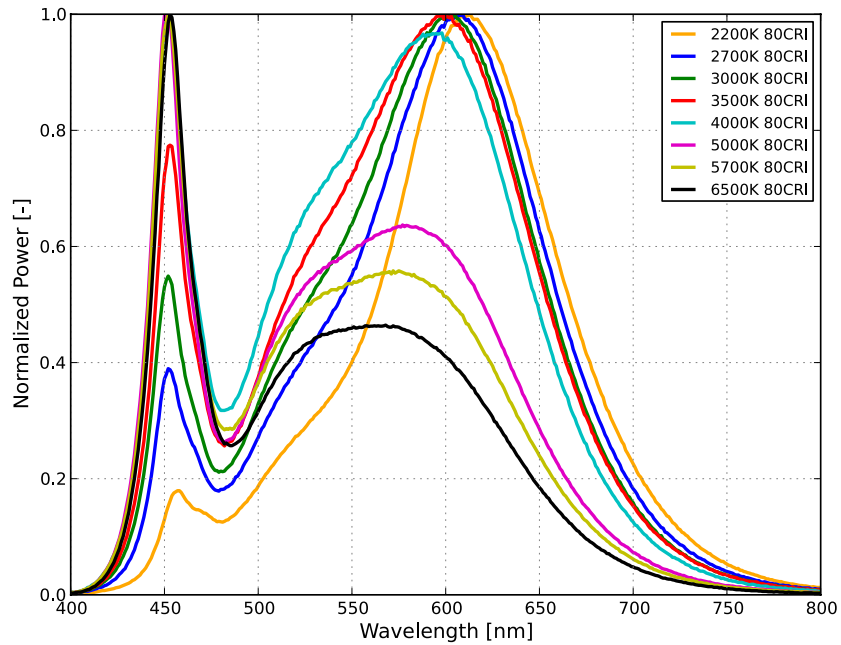

Figure 1b. Typical normalized power vs. wavelength for 80CRI LUXEON 2835E and LUXEON 2835C at test current, $T_j=25^{\circ}\text{C}$.

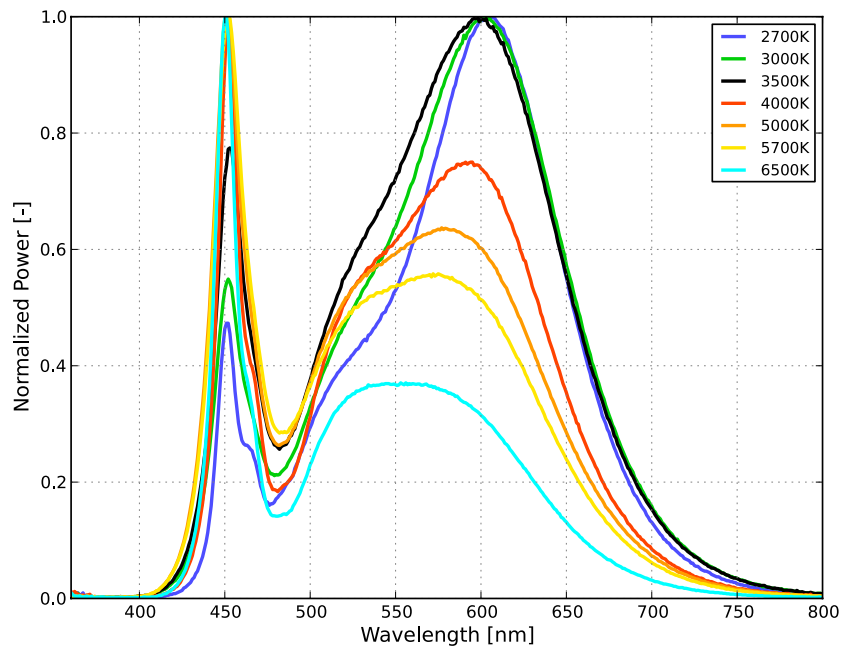

Figure 1c. Typical normalized power vs. wavelength for 80CRI LUXEON 2835 HE at test current, $T_j=25^\circ\text{C}$.

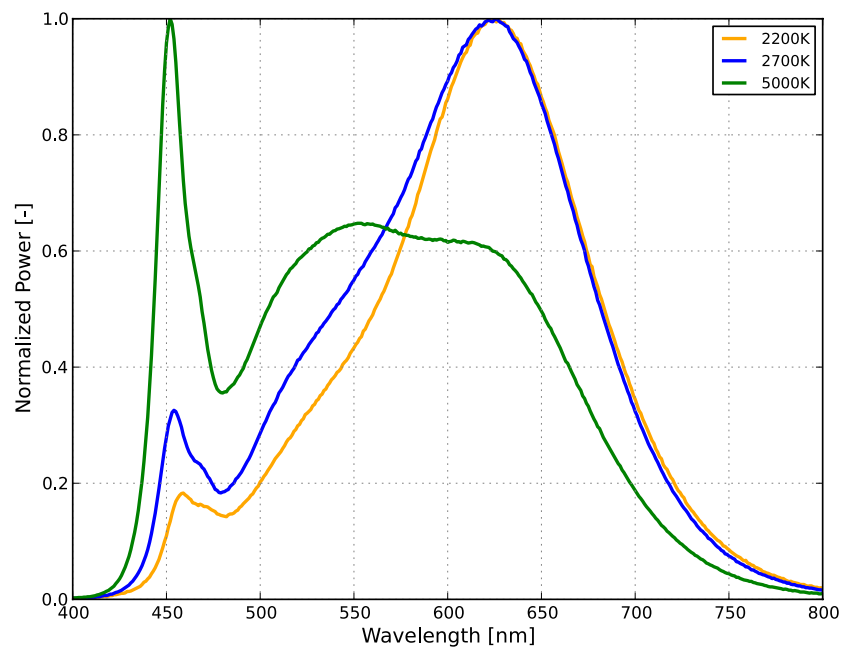

Figure 1d. Typical normalized power vs. wavelength for 90CRI LUXEON 2835E and LUXEON 2835C at test current, $T_j=25^\circ\text{C}$.

Light Output Characteristics

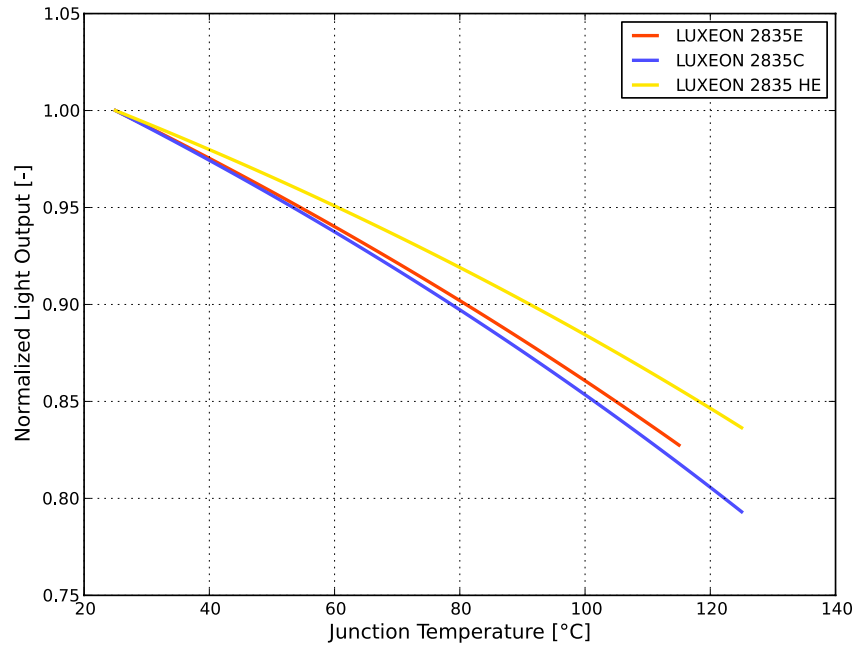
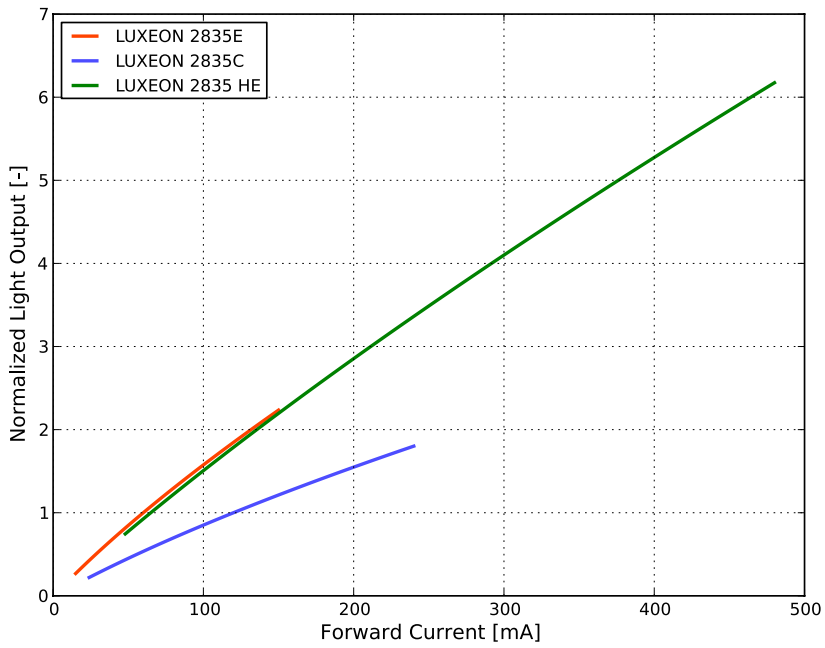

Figure 2. Typical normalized light output vs. junction temperature for LUXEON 2835 Line at test current.



LUXEON 2835E estimated typical ratio compared to flux at rated condition 60mA, $T_j=25^{\circ}\text{C}$.

PRODUCT	30mA	50mA	80mA	100mA	120mA
2835E 3V	53%	85%	129%	158%	185%
2835E 6V	53%	85%	129%	156%	182%
2835E 9V	53%	85%	129%	156%	181%

LUXEON 2835C estimated typical ratio compared to flux at rated condition 120mA, $T_j=25^{\circ}\text{C}$.

PRODUCT	50mA	65mA	100mA	150mA	200mA
2835C 3V	44%	56%	85%	123%	159%
2835C 6V	44%	56%	84%	123%	158%

LUXEON 2835 HE estimated typical ratio compared to flux at rated condition 65mA, $T_j=25^{\circ}\text{C}$.

PRODUCT	30mA	100mA	120mA	240mA	360mA
2835 HE 3V	47%	152%	181%	346%	498%

Figure 3. Typical normalized light output vs. forward current for LUXEON 2835 Line at $T_j=25^{\circ}\text{C}$.

Forward Current Characteristics

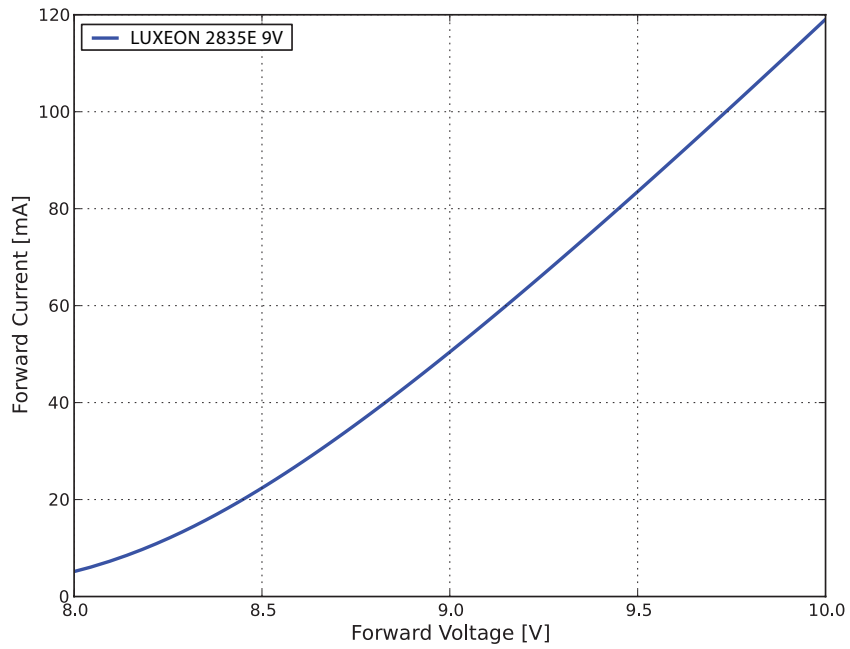

Figure 4a. Typical forward current vs. forward voltage for LUXEON 2835E 9V at $T_j=25^\circ\text{C}$.

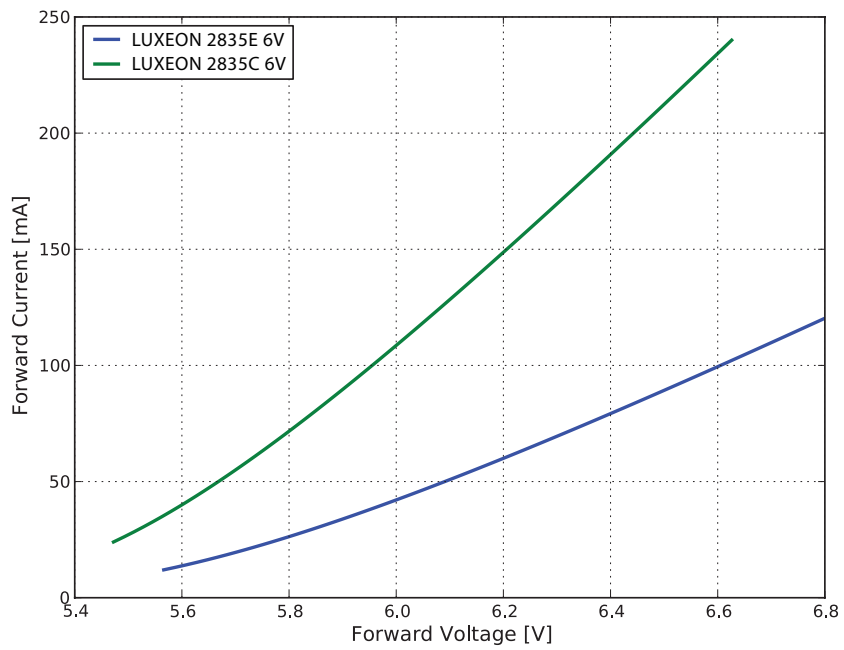

Figure 4b. Typical forward current vs. forward voltage for LUXEON 2835E 6V and LUXEON 2835C 6V at $T_j=25^\circ\text{C}$.

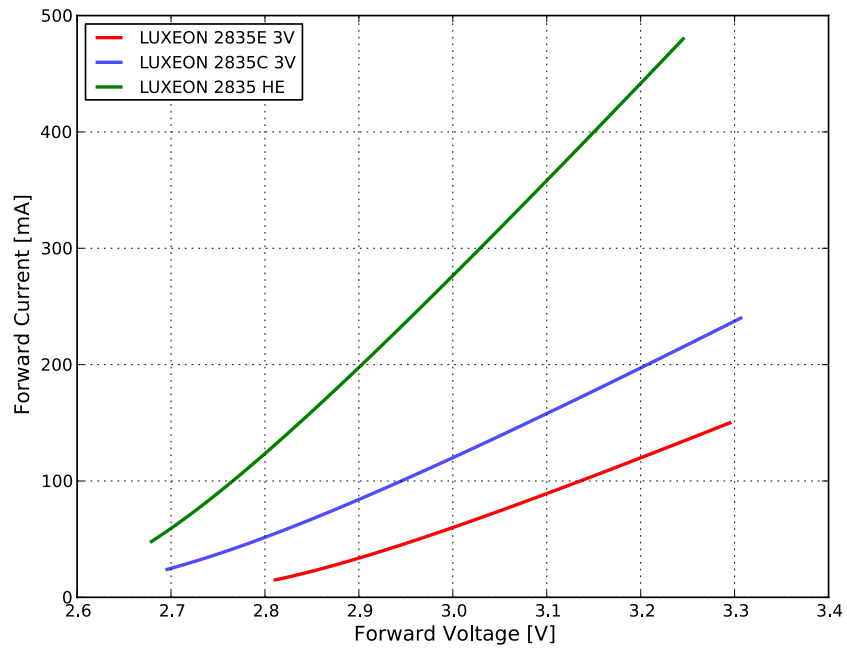

Figure 4c. Typical forward current vs. forward voltage for LUXEON 2835C 3V at $T_j=25^\circ\text{C}$.

Radiation Pattern Characteristics

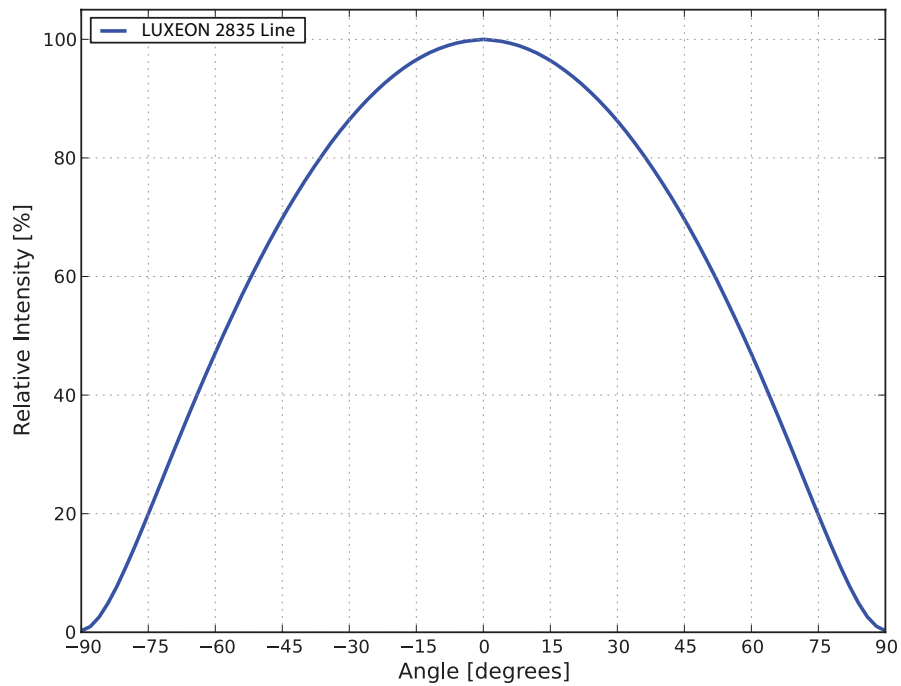

Figure 5. Typical radiation pattern for LUXEON 2835 Line at test current, $T_j=25^\circ\text{C}$.

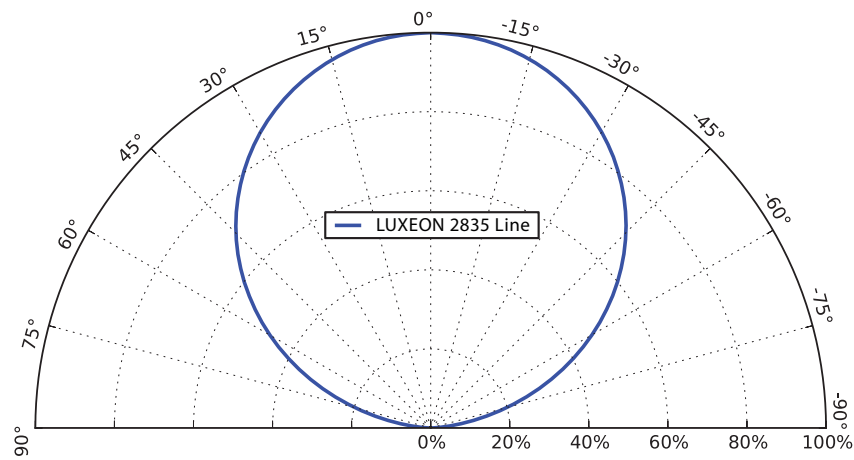

Figure 6. Typical polar radiation pattern for LUXEON 2835 Line at test current, $T_j=25^\circ\text{C}$.

Product Bin and Labeling Definitions

Decoding Product Bin Labeling

In the manufacturing of semiconductor products, there are variations in performance around the average values given in the technical datasheet. For this reason, Lumileds bins LED components for luminous flux or radiometric power, color point, peak or dominant wavelength and forward voltage.

LUXEON 2835 Line LEDs are labeled using a 4- or 5-digit alphanumeric CAT code following the format below:

A or Ax B C D

Where:

- A or Ax** – designates luminous flux bin (example: T=56 to 60 lumens, D2=29 to 31 lumens)
- B C** – designates correlated color bin (example: 5D, 5E, 5F, 5G, 5H, 5J, 5K, 5L, 5M for 4000K parts)
- D** – designates forward voltage bin (example: W=3.0 to 3.1V, X=3.1 to 3.2V)

Therefore, a LUXEON 2835C 3V with a lumen range of 56 to 60, color bin of 5D and a forward voltage range of 3.0 to 3.1V has the following CAT code:

T 5 D W

Luminous Flux Bins

Table 5 lists the standard luminous flux bins for LUXEON 2835 Line emitters. Although several bins are outlined, product availability in a particular bin varies by production run and by product performance. Not all bins are available in all CCTs.

Table 5. Luminous flux bin definitions for LUXEON 2835 Line, $T_j=25^\circ\text{C}$.

PRODUCT	BIN	LUMINOUS FLUX ⁽¹⁾ (lm)	
		MINIMUM	MAXIMUM
LUXEON 2835E 9V LUXEON 2835C 6V	Z	50	55
	A	55	60
	B	60	65
	C	65	70
	D	70	75
	E	75	80
	F	80	85
	G	85	90
	H	90	95
	J	95	100
	K	100	105
	L	105	110
	M	110	115
	N	115	120
LUXEON 2835E 3V	P	120	125
	Q	125	130
	B1	19	21
	B2	21	23
	C1	23	25
	C2	25	27
	D1	27	29
LUXEON 2835C 3V LUXEON 2835C 3V TVS LUXEON 2835E 6V	D2	29	31
	E1	31	33
	P	40	44
	Q	44	48
	R	48	52
	S	52	56
	T	56	60
	U	60	65
LUXEON 2835 HE 3V	V	65	70
	W	70	75
	A	28.0	29.5
	B	29.5	31.0
	C	31.0	32.5
	D	32.5	34.0
	E	34.0	35.5
F	35.5	37.0	
	G	37.0	38.5

Notes for Table 5:

1. Lumileds maintains a tolerance of $\pm 7.5\%$ on luminous flux measurements.

Color Bin Definition

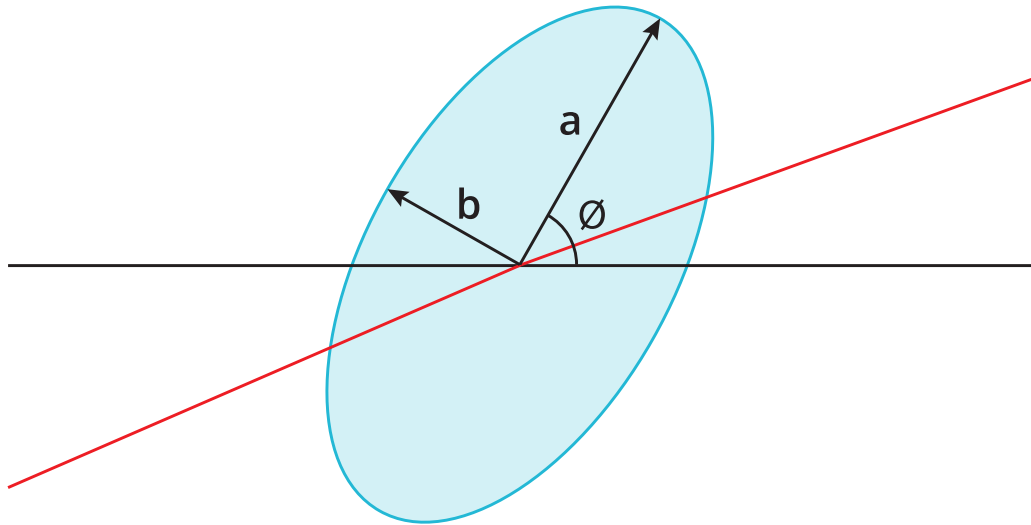

Figure 7. 3- and 5-step MacAdam ellipse illustration for Tables 6a-6h.

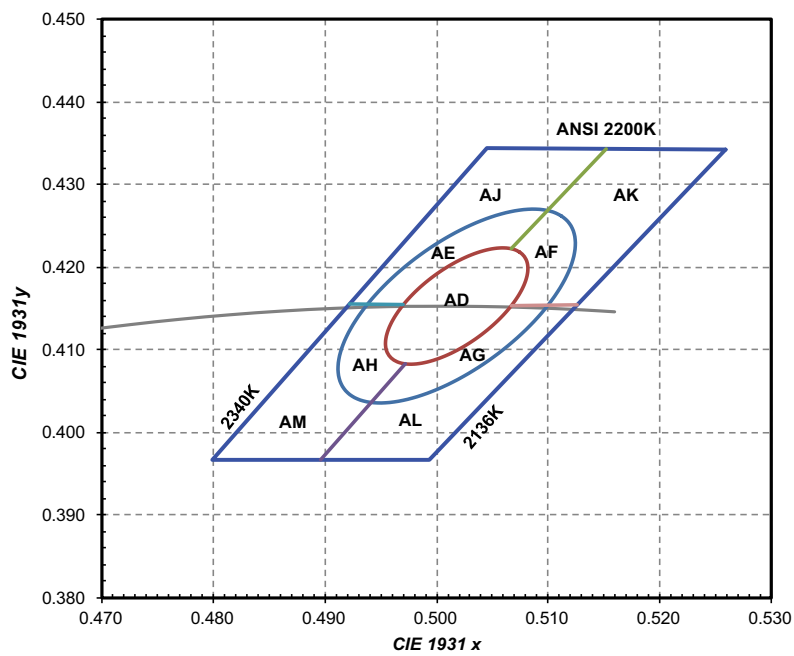

Figure 8a. 1/9th color bin structure for LUXEON 2835E and LUXEON 2835C 2200K at test current and binning temperatures of $T_j=25^{\circ}\text{C}$ and $T_j=85^{\circ}\text{C}$.

Table 6a. 3- and 5-step MacAdam ellipse color bin definitions for LUXEON 2835E and LUXEON 2835C 2200K, at test and binning conditions.

NOMINAL CCT	COLOR SPACE	CENTER POINT ^[1] (cx, cy)	MAJOR AXIS, a	MINOR AXIS, b	ELLIPSE ROTATION ANGLE, θ
2200K	Single 3-step MacAdam ellipse	(0.5018, 0.4153)	0.00863	0.00398	49.27°
2200K	Single 5-step MacAdam ellipse	(0.5018, 0.4153)	0.01438	0.00663	49.27°

Notes for Table 6a:

1. Lumileds maintains a tolerance of ± 0.007 on x and y color coordinates in the CIE 1931 color space.

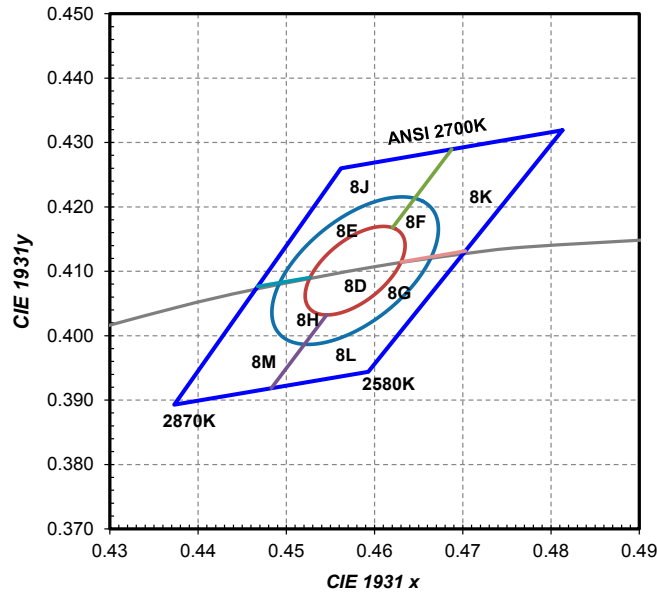

Figure 8b. 1/9th color bin structure for LUXEON 2835E and LUXEON 2835C 2700K at test current and binning temperatures of $T_j=25^\circ\text{C}$ and $T_j=85^\circ\text{C}$.

Table 6b. 3- and 5-step MacAdam ellipse color bin definitions for LUXEON 2835E and LUXEON 2835C 2700K, at test and binning conditions.

NOMINAL CCT	COLOR SPACE	CENTER POINT ⁽¹⁾ (cx, cy)	MAJOR AXIS, a	MINOR AXIS, b	ELLIPSE ROTATION ANGLE, θ
2700K	Single 3-step MacAdam ellipse	(0.4578, 0.4101)	0.00810	0.00420	53.70°
2700K	Single 5-step MacAdam ellipse	(0.4578, 0.4101)	0.01350	0.00700	53.70°

Notes for Table 6b:

1. Lumileds maintains a tolerance of ± 0.007 on x and y color coordinates in the CIE 1931 color space.

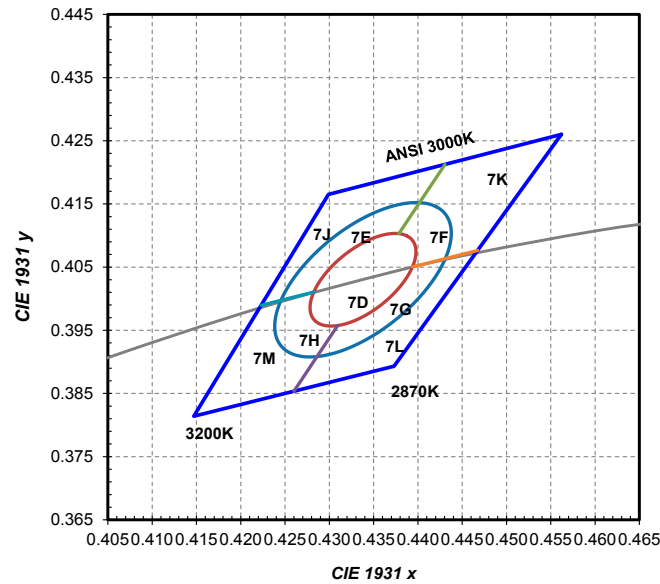

Figure 8c. 1/9th color bin structure for LUXEON 2835E and LUXEON 2835C 3000K at test current and binning temperatures of $T_j=25^\circ\text{C}$ and $T_j=85^\circ\text{C}$.

Table 6c. 3- and 5-step MacAdam ellipse color bin definitions for LUXEON 2835E and LUXEON 2835C 3000K, at test and binning conditions.

NOMINAL CCT	COLOR SPACE	CENTER POINT ⁽¹⁾ (cx, cy)	MAJOR AXIS, a	MINOR AXIS, b	ELLIPSE ROTATION ANGLE, θ
3000K	Single 3-step MacAdam ellipse	(0.4338, 0.4030)	0.00834	0.00408	53.22°
3000K	Single 5-step MacAdam ellipse	(0.4338, 0.4030)	0.01390	0.00680	53.22°

Notes for Table 6c:

1. Lumileds maintains a tolerance of ± 0.007 on x and y color coordinates in the CIE 1931 color space.

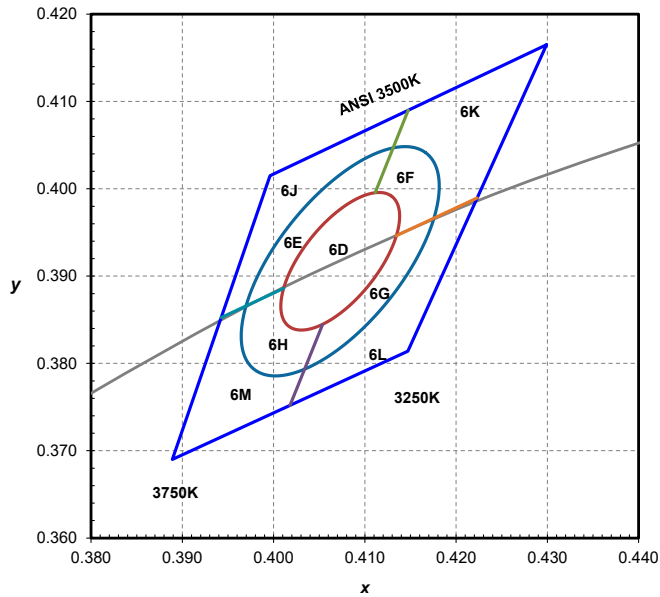

Figure 8d. 1/9th color bin structure for LUXEON 2835E and LUXEON 2835C 3500K at test current and binning temperatures of $T_j=25^\circ\text{C}$ and $T_j=85^\circ\text{C}$.

Table 6d. 3- and 5-step MacAdam ellipse color bin definitions for LUXEON 2835E and LUXEON 2835C 3500K, at test and binning conditions.

NOMINAL CCT	COLOR SPACE	CENTER POINT ^[1] (cx, cy)	MAJOR AXIS, a	MINOR AXIS, b	ELLIPSE ROTATION ANGLE, θ
3500K	Single 3-step MacAdam ellipse	(0.4073, 0.3917)	0.00927	0.00414	54.00°
3500K	Single 5-step MacAdam ellipse	(0.4073, 0.3917)	0.01545	0.00690	54.00°

Notes for Table 6d:

1. Lumileds maintains a tolerance of ± 0.007 on x and y color coordinates in the CIE 1931 color space.

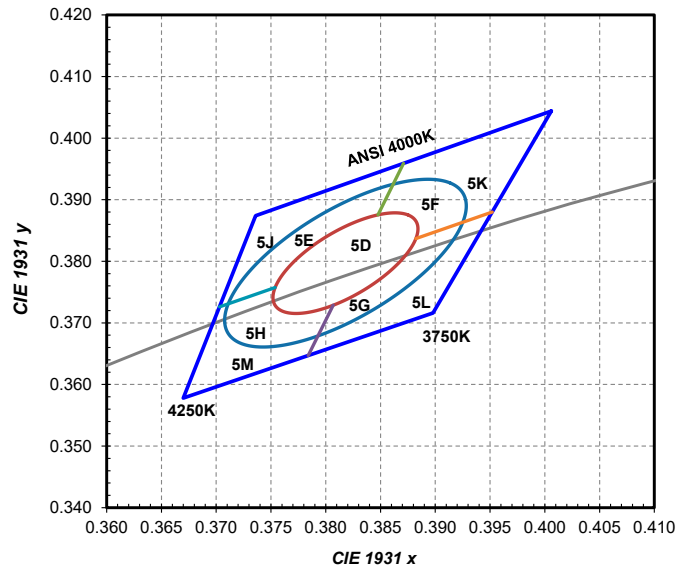

Figure 8e. 1/9th color bin structure for LUXEON 2835E and LUXEON 2835C 4000K at test current and binning temperatures of $T_j=25^\circ\text{C}$ and $T_j=85^\circ\text{C}$.

Table 6e. 3- and 5-step MacAdam ellipse color bin definitions for LUXEON 2835E and LUXEON 2835C 4000K, at test and binning conditions.

NOMINAL CCT	COLOR SPACE	CENTER POINT ^[1] (cx, cy)	MAJOR AXIS, a	MINOR AXIS, b	ELLIPSE ROTATION ANGLE, θ
4000K	Single 3-step MacAdam ellipse	(0.3818, 0.3797)	0.00939	0.00402	53.72°
4000K	Single 5-step MacAdam ellipse	(0.3818, 0.3797)	0.01565	0.00670	53.72°

Notes for Table 6e:

1. Lumileds maintains a tolerance of ± 0.007 on x and y color coordinates in the CIE 1931 color space.

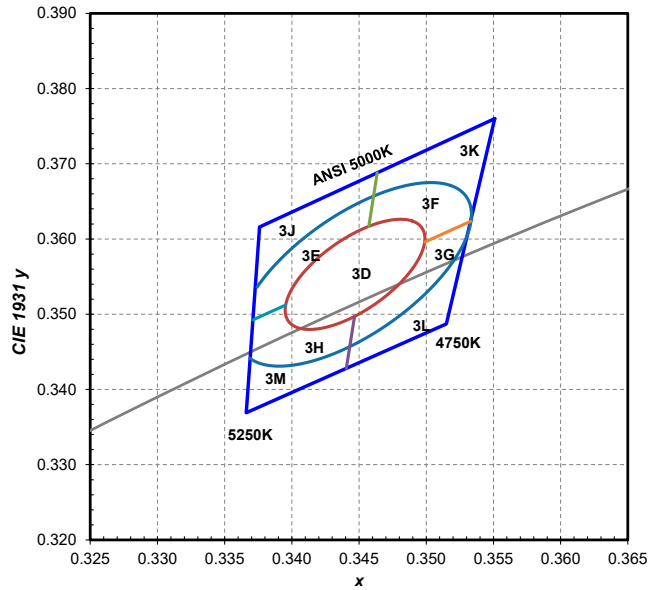

Figure 8f. 1/9th color bin structure for LUXEON 2835E and LUXEON 2835C 5000K at test current and binning temperatures of $T_j=25^\circ\text{C}$ and $T_j=85^\circ\text{C}$.

Table 6f. 3- and 5-step MacAdam ellipse color bin definitions for LUXEON 2835E and LUXEON 2835C 5000K, at test and binning conditions.

NOMINAL CCT	COLOR SPACE	CENTER POINT ⁽¹⁾ (cx, cy)	MAJOR AXIS, a	MINOR AXIS, b	ELLIPSE ROTATION ANGLE, θ
5000K	Single 3-step MacAdam ellipse	(0.3447, 0.3553)	0.00822	0.00354	59.62°
5000K	Single 5-step MacAdam ellipse	(0.3447, 0.3553)	0.01370	0.00590	59.62°

Notes for Table 6f:

1. Lumileds maintains a tolerance of ± 0.007 on x and y color coordinates in the CIE 1931 color space.

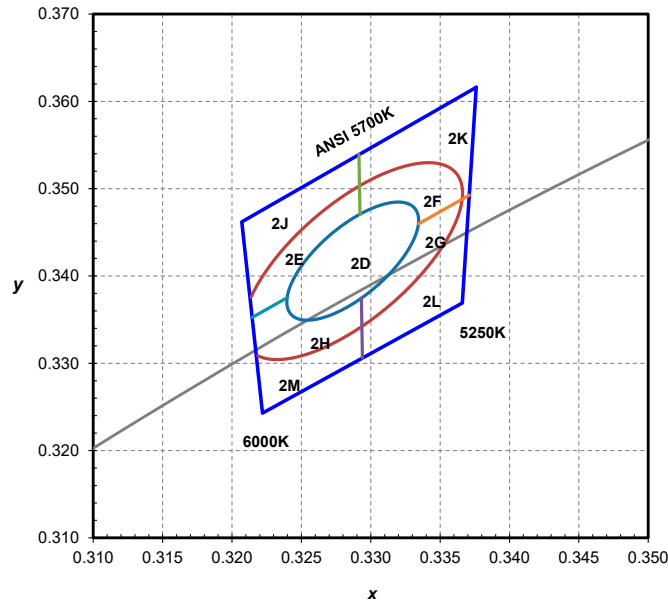

Figure 8g. 1/9th color bin structure for LUXEON 2835E and LUXEON 2835C 5700K at test current and binning temperatures of $T_j=25^\circ\text{C}$ and $T_j=85^\circ\text{C}$.

Table 6g. 3- and 5-step MacAdam ellipse color bin definitions for LUXEON 2835E and LUXEON 2835C 5700K, at test and binning conditions.

NOMINAL CCT	COLOR SPACE	CENTER POINT ⁽¹⁾ (cx, cy)	MAJOR AXIS, a	MINOR AXIS, b	ELLIPSE ROTATION ANGLE, θ
5700K	Single 3-step MacAdam ellipse	(0.3287, 0.3417)	0.00746	0.00320	59.09°
5700K	Single 5-step MacAdam ellipse	(0.3287, 0.3417)	0.01243	0.00533	59.09°

Notes for Table 6g:

1. Lumileds maintains a tolerance of ± 0.007 on x and y color coordinates in the CIE 1931 color space.

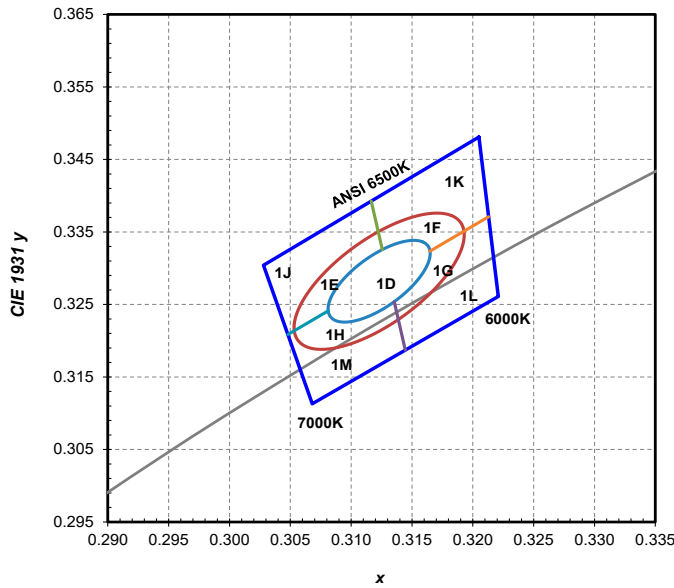

Figure 8h. 1/9th color bin structure for LUXEON 2835E and LUXEON 2835C 6500K at test current and binning temperatures of $T_j=25^{\circ}\text{C}$ and $T_j=85^{\circ}\text{C}$.

Table 6h. 3- and 5-step MacAdam ellipse color bin definitions for LUXEON 2835E and LUXEON 2835C 6500K, at test and binning conditions.

NOMINAL CCT	COLOR SPACE	CENTER POINT ^[1] (cx, cy)	MAJOR AXIS, a	MINOR AXIS, b	ELLIPSE ROTATION ANGLE, θ
6500K	Single 3-step MacAdam ellipse	(0.3123, 0.3282)	0.00669	0.00285	58.57°
6500K	Single 5-step MacAdam ellipse	(0.3123, 0.3282)	0.01115	0.00475	58.57°

Notes for Table 6h:

- Lumileds maintains a tolerance of ± 0.007 on x and y color coordinates in the CIE 1931 color space.

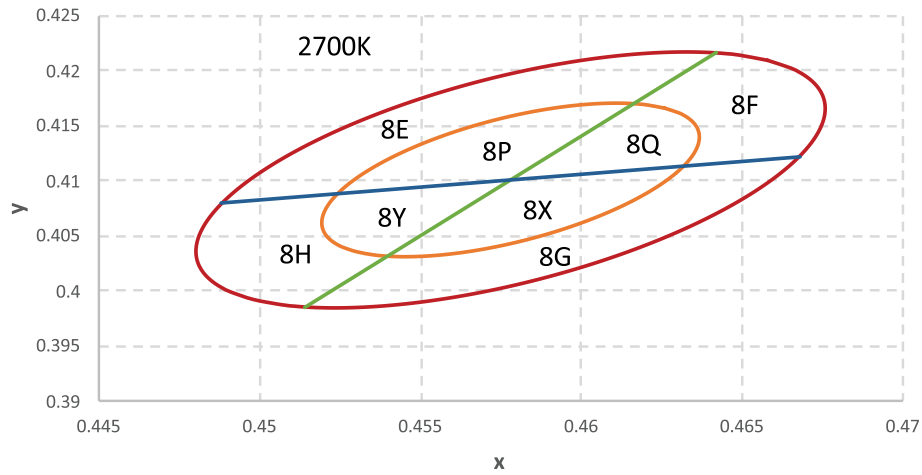

Figure 8i. 1/8th color bin structure for LUXEON 2835 HE 2700K at test current and binning temperature of $T_j=25^{\circ}\text{C}$.

Table 6i-1. 3- and 5-step MacAdam ellipse color bin definitions for LUXEON 2835 HE 2700K, at test and binning conditions.

NOMINAL CCT	COLOR SPACE	CENTER POINT ⁽¹⁾ (cx, cy)	MAJOR AXIS, a	MINOR AXIS, b	ELLIPSE ROTATION ANGLE, θ
2700K	Single 3-step MacAdam ellipse	(0.4578, 0.4101)	0.00810	0.00420	53.70°
2700K	Single 5-step MacAdam ellipse	(0.4578, 0.4101)	0.01350	0.00700	53.70°

Table 6i-2. 4 quadrants definition for LUXEON 2835 HE 2700K, at test and binning conditions.

POINT	x	y
1	0.4642	0.4217
2	0.4488	0.4080
3	0.4514	0.3985
4	0.4668	0.4122
Center	0.4578	0.4101

Notes for Table 6i:

1. Lumileds maintains a tolerance of ± 0.007 on x and y color coordinates in the CIE 1931 color space.

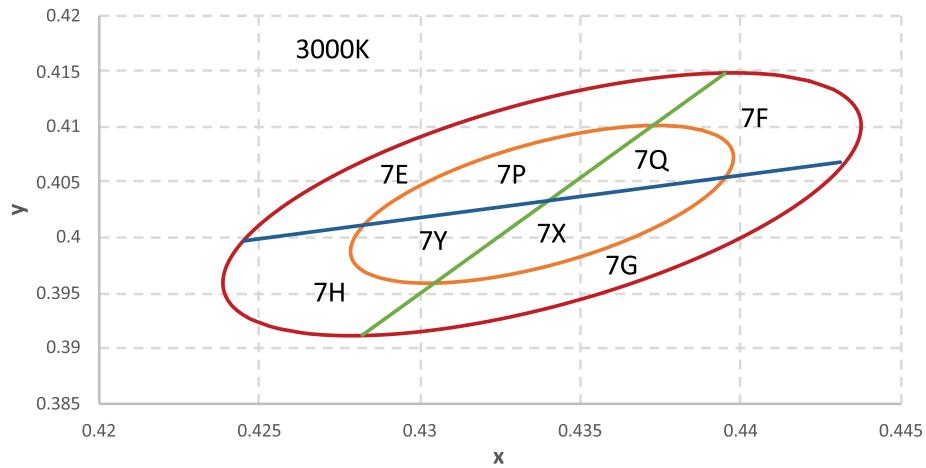

Figure 8j. 1/8th color bin structure for LUXEON 2835 HE 3000K at test current and binning temperature of $T_j=25^\circ\text{C}$.

Table 6j-1. 3- and 5-step MacAdam ellipse color bin definitions for LUXEON 2835 HE 3000K, at test and binning conditions.

NOMINAL CCT	COLOR SPACE	CENTER POINT ⁽¹⁾ (cx, cy)	MAJOR AXIS, a	MINOR AXIS, b	ELLIPSE ROTATION ANGLE, θ
3000K	Single 3-step MacAdam ellipse	(0.4338, 0.4030)	0.00834	0.00408	53.22°
3000K	Single 5-step MacAdam ellipse	(0.4338, 0.4030)	0.01390	0.00680	53.22°

Table 6j-2. 4 quadrants definition for LUXEON 2835 HE 3000K, at test and binning conditions.

POINT	x	y
1	0.4395	0.4148
2	0.4245	0.3997
3	0.4282	0.3912
4	0.4431	0.4062
Center	0.4338	0.4030

Notes for Table 6j:

1. Lumileds maintains a tolerance of ± 0.007 on x and y color coordinates in the CIE 1931 color space.

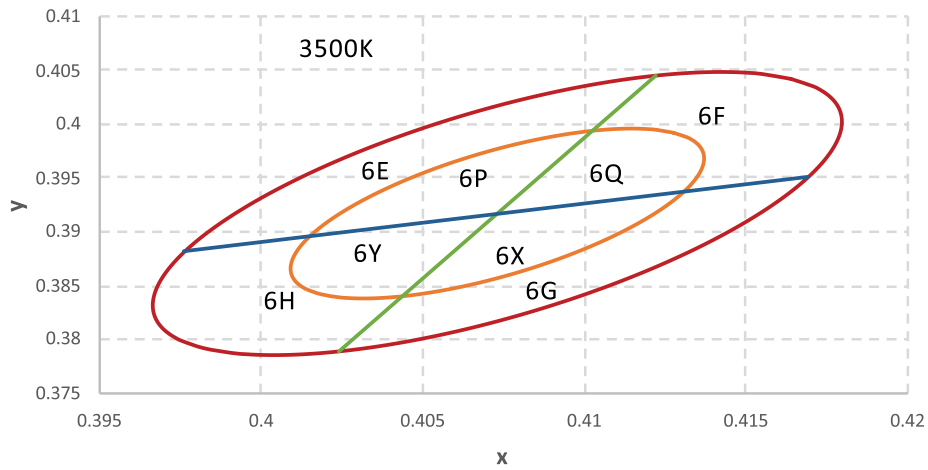

Figure 8k. 1/8th color bin structure for LUXEON 2835 HE 3500K at test current and binning temperature of $T_j=25^{\circ}\text{C}$.

Table 6k-1. 3- and 5-step MacAdam ellipse color bin definitions for LUXEON 2835 HE 3500K, at test and binning conditions.

NOMINAL CCT	COLOR SPACE	CENTER POINT ⁽¹⁾ (cx, cy)	MAJOR AXIS, a	MINOR AXIS, b	ELLIPSE ROTATION ANGLE, θ
3500K	Single 3-step MacAdam ellipse	(0.4073, 0.3917)	0.00927	0.00414	54.00°
3500K	Single 5-step MacAdam ellipse	(0.4073, 0.3917)	0.01545	0.00690	54.00°

Table 6k-2. 4 quadrants definition for LUXEON 2835 HE 3500K, at test and binning conditions.

POINT	x	y
1	0.4122	0.4045
2	0.3976	0.3882
3	0.4024	0.3789
4	0.4169	0.3951
Center	0.4073	0.3917

Notes for Table 6k:

- Lumileds maintains a tolerance of ± 0.007 on x and y color coordinates in the CIE 1931 color space.

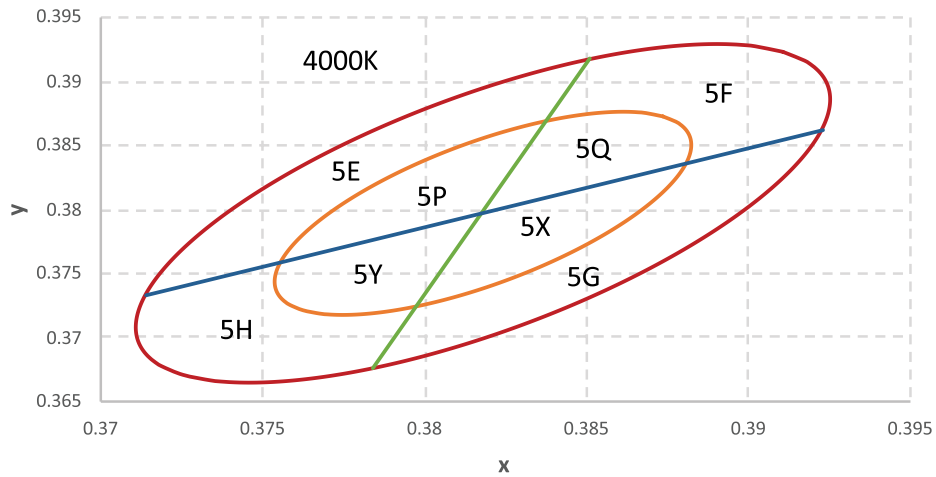

Figure 8l. 1/8th color bin structure for LUXEON 2835 HE 4000K at test current and binning temperature of $T_j=25^{\circ}\text{C}$.

Table 6l-1. 3- and 5-step MacAdam ellipse color bin definitions for LUXEON 2835 HE 4000K, at test and binning conditions.

NOMINAL CCT	COLOR SPACE	CENTER POINT ^[1] (cx, cy)	MAJOR AXIS, a	MINOR AXIS, b	ELLIPSE ROTATION ANGLE, θ
4000K	Single 3-step MacAdam ellipse	(0.3818, 0.3797)	0.00939	0.00402	53.72°
4000K	Single 5-step MacAdam ellipse	(0.3818, 0.3797)	0.01565	0.00670	53.72°

Table 6l-2. 4 quadrants definition for LUXEON 2835 HE 4000K, at test and binning conditions.

POINT	x	y
1	0.3851	0.3918
2	0.3714	0.3733
3	0.3784	0.3676
4	0.3923	0.3862
Center	0.3818	0.3797

Notes for Table 6l:

1. Lumileds maintains a tolerance of ± 0.007 on x and y color coordinates in the CIE 1931 color space.

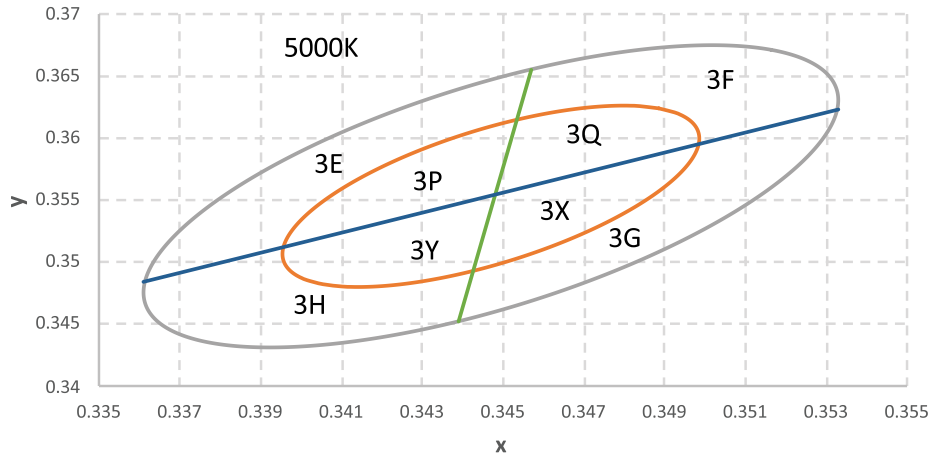

Figure 8m. 1/8th color bin structure for LUXEON 2835 HE 5000K at test current and binning temperature of $T_j=25^{\circ}\text{C}$.

Table 6m-1. 3- and 5-step MacAdam ellipse color bin definitions for LUXEON 2835 HE 5000K, at test and binning conditions.

NOMINAL CCT	COLOR SPACE	CENTER POINT ^[1] (cx, cy)	MAJOR AXIS, a	MINOR AXIS, b	ELLIPSE ROTATION ANGLE, θ
5000K	Single 3-step MacAdam ellipse	(0.3447, 0.3553)	0.00822	0.00354	59.62°
5000K	Single 5-step MacAdam ellipse	(0.3447, 0.3553)	0.01370	0.00590	59.62°

Table 6m-2. 4 quadrants definition for LUXEON 2835 HE 5000K, at test and binning conditions.

POINT	x	y
1	0.3457	0.3655
2	0.3361	0.3484
3	0.3439	0.3452
4	0.3533	0.3623
Center	0.3447	0.3553

Notes for Table 6m:

1. Lumileds maintains a tolerance of ± 0.007 on x and y color coordinates in the CIE 1931 color space.

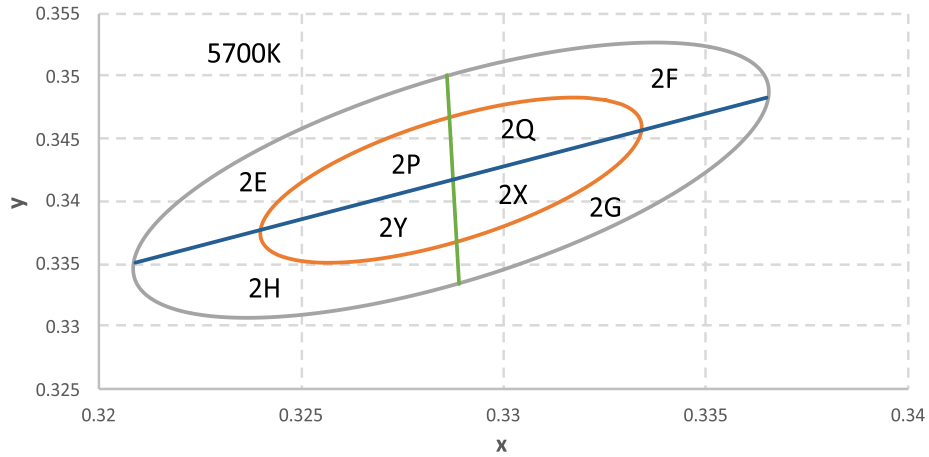

Figure 8n. 1/8th color bin structure for LUXEON 2835 HE 5700K at test current and binning temperature of $T_j=25^{\circ}\text{C}$.

Table 6n-1. 3- and 5-step MacAdam ellipse color bin definitions for LUXEON 2835 HE 5700K, at test and binning conditions.

NOMINAL CCT	COLOR SPACE	CENTER POINT ⁽¹⁾ (cx, cy)	MAJOR AXIS, a	MINOR AXIS, b	ELLIPSE ROTATION ANGLE, θ
5700K	Single 3-step MacAdam ellipse	(0.3287, 0.3417)	0.00746	0.00320	59.09°
5700K	Single 5-step MacAdam ellipse	(0.3287, 0.3417)	0.01243	0.00533	59.09°

Table 6n-2. 4 quadrants definition for LUXEON 2835 HE 5700K, at test and binning conditions.

POINT	x	y
1	0.3286	0.3501
2	0.3209	0.3351
3	0.3289	0.3334
4	0.3365	0.3483
Center	0.3287	0.3417

Notes for Table 6n:

1. Lumileds maintains a tolerance of ± 0.007 on x and y color coordinates in the CIE 1931 color space.

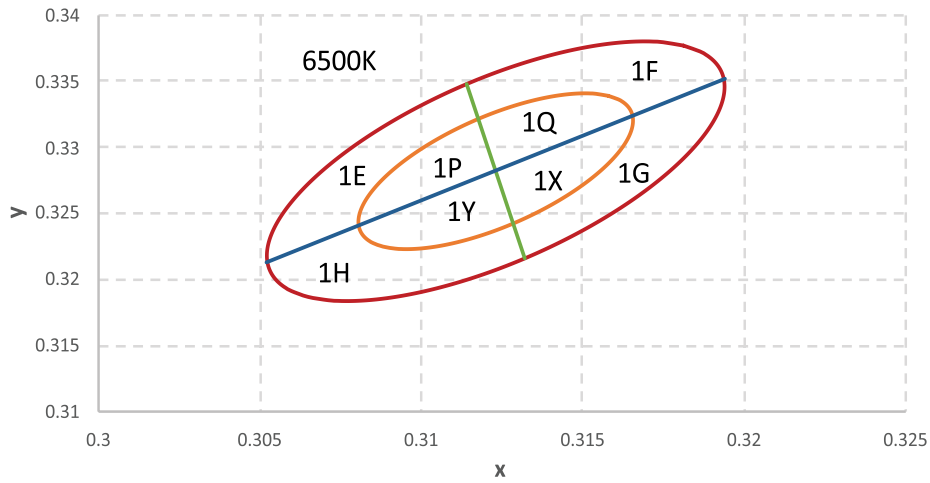

Figure 8o. 1/8th color bin structure for LUXEON 2835 HE 6500K at test current and binning temperature of $T_j=25^{\circ}\text{C}$.

Table 6o-1. 3- and 5-step MacAdam ellipse color bin definitions for LUXEON 2835 HE 6500K, at test and binning conditions.

NOMINAL CCT	COLOR SPACE	CENTER POINT ⁽¹⁾ (cx, cy)	MAJOR AXIS, a	MINOR AXIS, b	ELLIPSE ROTATION ANGLE, θ
6500K	Single 3-step MacAdam ellipse	(0.3123, 0.3282)	0.00669	0.00285	58.57°
6500K	Single 5-step MacAdam ellipse	(0.3123, 0.3282)	0.01115	0.00475	58.57°

Table 6o-2. 4 quadrants definition for LUXEON 2835 HE 6500K, at test and binning conditions.

POINT	x	y
1	0.3286	0.3501
2	0.3209	0.3351
3	0.3289	0.3334
4	0.3365	0.3483
Center	0.3287	0.3417

Notes for Table 6o:

1. Lumileds maintains a tolerance of ± 0.007 on x and y color coordinates in the CIE 1931 color space.

Forward Voltage Bins

Table 7. Forward voltage bin definitions for LUXEON 2835 Line at test current, $T_j=25^{\circ}\text{C}$.

PRODUCT	BIN	FORWARD VOLTAGE ⁽¹⁾ (V _f)	
		MINIMUM	MAXIMUM
LUXEON 2835E 9V	V	8.70	9.00
	W	9.00	9.30
	X	9.30	9.60
	Y	9.60	9.90
LUXEON 2835E 6V	V	5.80	6.00
	W	6.00	6.20
	X	6.20	6.40
	Y	6.40	6.60
LUXEON 2835C 6V	G	5.80	6.00
	H	6.00	6.20
	J	6.20	6.40
LUXEON 2835E 3V LUXEON 2835C 3V LUXEON 2835C 3V TVS	S	2.70	2.80
	T	2.80	2.90
	V	2.90	3.00
	W	3.00	3.10
	X	3.10	3.20
LUXEON 2835 HE 3V	Y	3.20	3.30
	A	2.54	2.62
	B	2.62	2.70
	C	2.70	2.78

Notes for Table 7:

1. Lumileds maintains a tolerance of $\pm 0.10\text{V}$ on forward voltage measurements.

Mechanical Dimensions

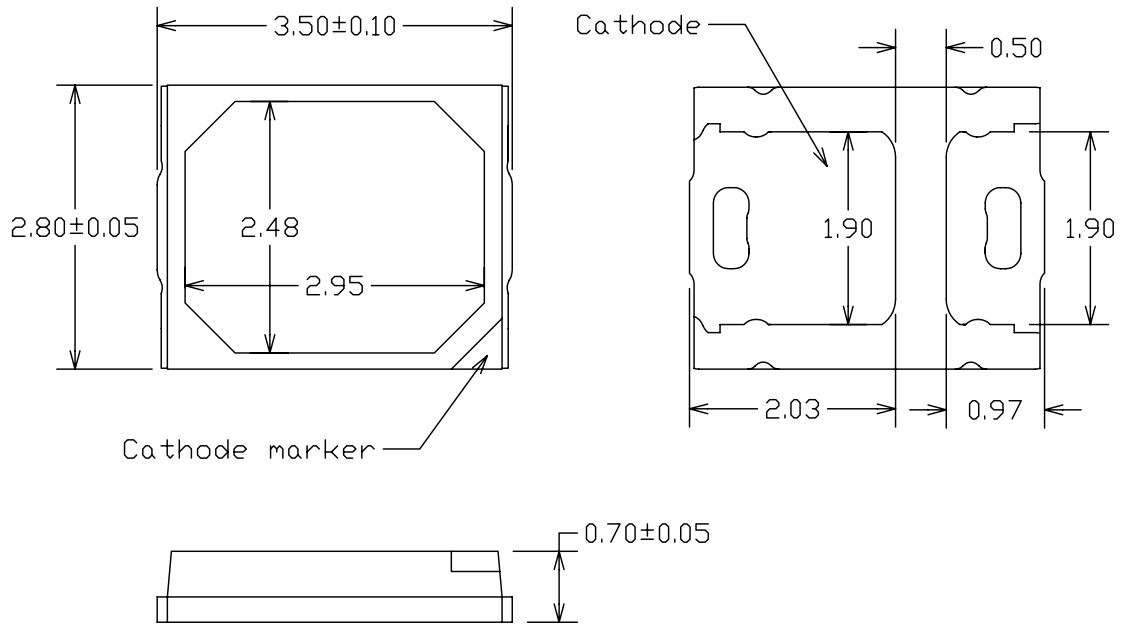

Figure 9. Mechanical dimensions for LUXEON 2835 Line.

Notes for Figure 9:

1. Drawings are not to scale.
2. All dimensions are in millimeters.

Reflow Soldering Guidelines

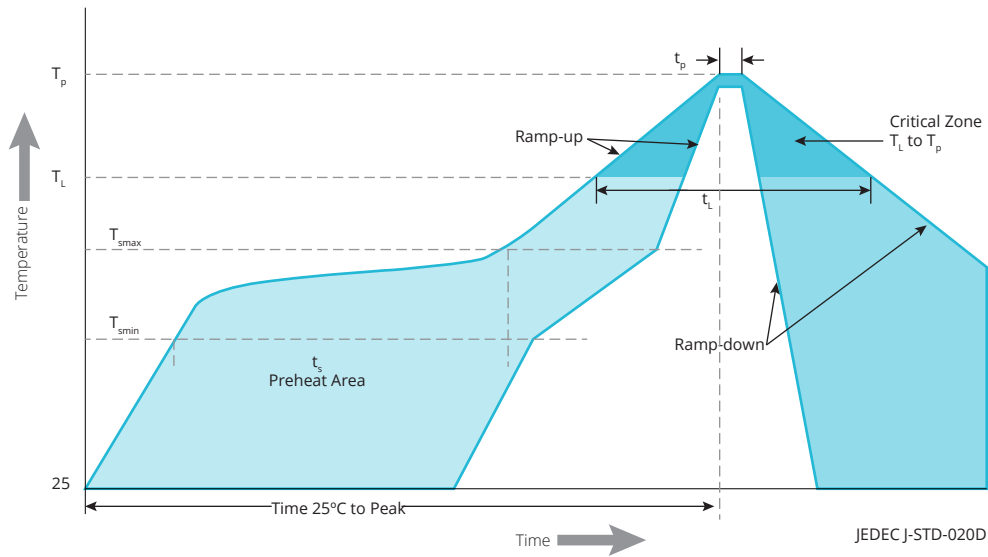

Figure 10. Visualization of the acceptable reflow temperature profile as specified in Table 8.

Table 8. Reflow profile characteristics for LUXEON 2835 Line.

PROFILE FEATURE	LEAD-FREE ASSEMBLY
Preheat Minimum Temperature (T_{smin})	150°C
Preheat Maximum Temperature (T_{smax})	200°C
Preheat Time (t_{smin} to t_{smax})	60 to 120 seconds
Ramp-Up Rate (T_L to T_p)	3°C / second maximum
Liquidus Temperature (T_L)	217°C
Time Maintained Above Temperature T_L (t_L)	60 to 150 seconds
Peak / Classification Temperature (T_p)	260°C
Time Within 5°C of Actual Temperature (t_p)	20 to 40 seconds
Ramp-Down Rate (T_p to T_L)	6°C / second maximum
Time 25°C to Peak Temperature	8 minutes maximum

JEDEC Moisture Sensitivity

Table 9. Moisture sensitivity levels for LUXEON 2835 Line.

LEVEL	FLOOR LIFE		SOAK REQUIREMENTS STANDARD	
	TIME	CONDITIONS	TIME	CONDITIONS
3	168 Hours	≤30°C / 60% RH	192 Hours +5 / -0	30°C / 60% RH

Solder Pad Design

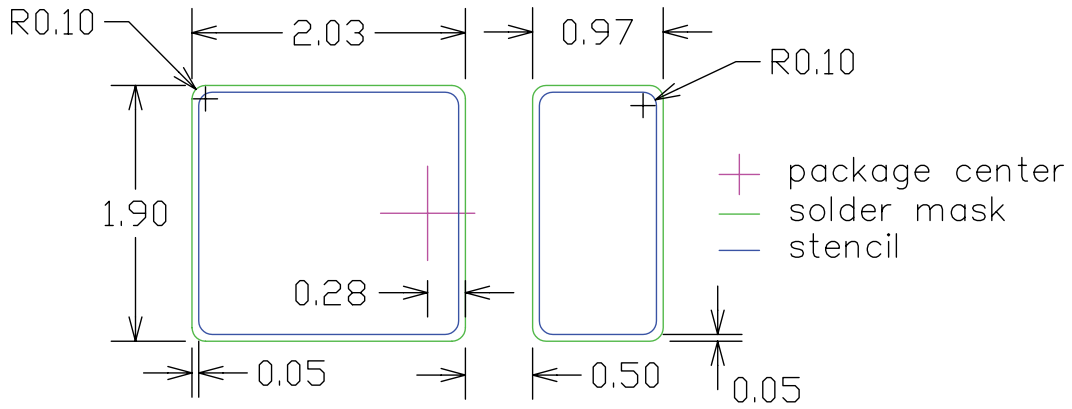

Figure 11. Recommended PCB solder pad layout for LUXEON 2835 Line.

- Notes for Figure 11:
1. Drawings are not to scale.
 2. All dimensions are in millimeters.

Packaging Information

Pocket Tape Dimensions

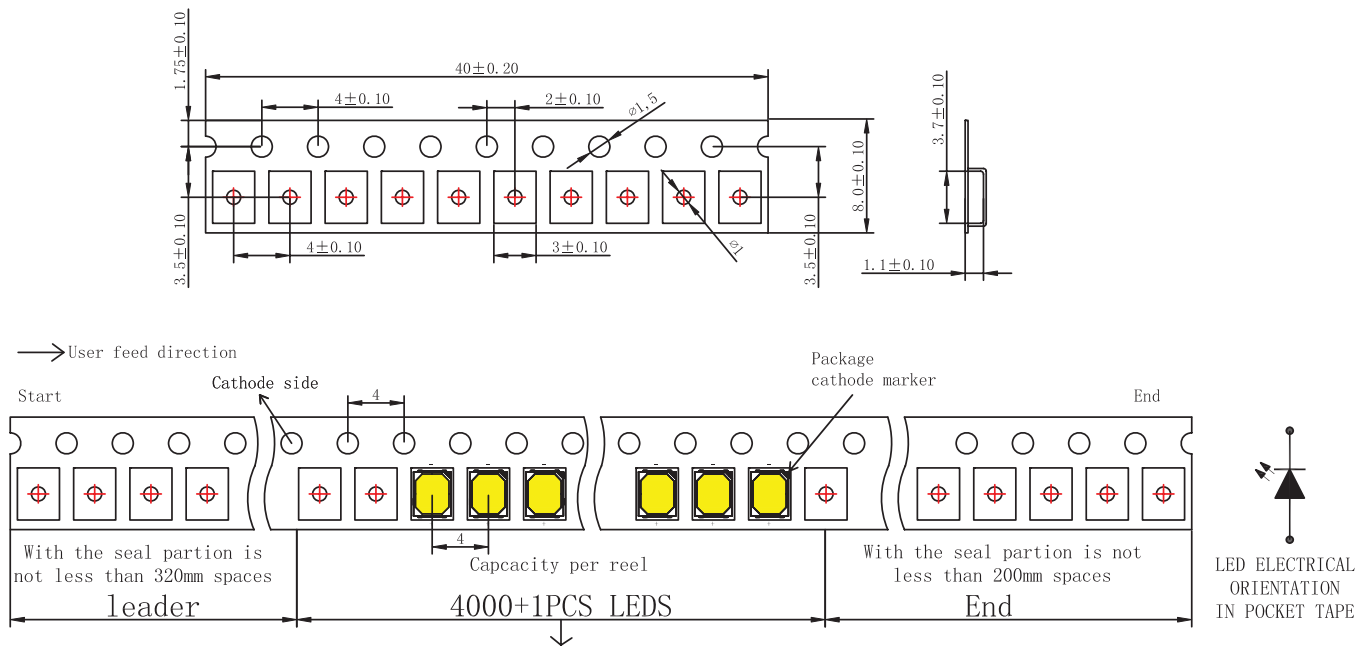

Figure 12. Pocket tape dimensions for LUXEON 2835 Line.

- Notes for Figure 12:
1. Drawings are not to scale.
 2. All dimensions are in millimeters.

Reel Dimensions

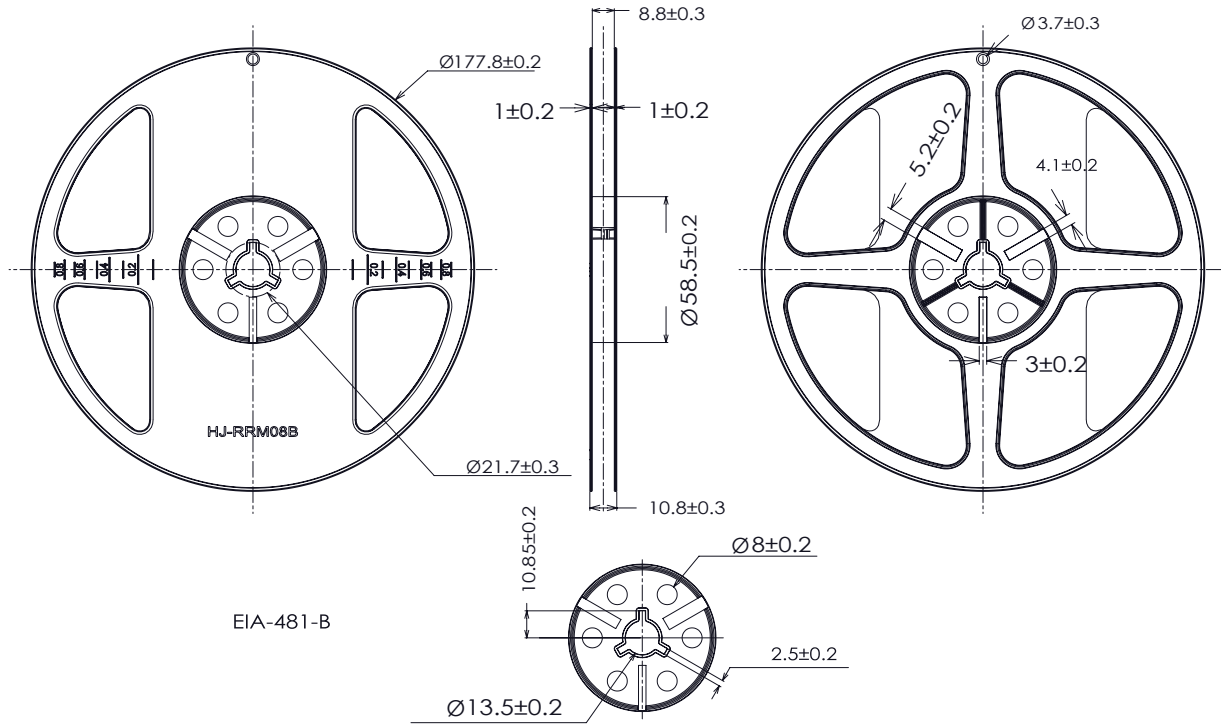

Figure 13. Reel dimensions for LUXEON 2835 Line.

Notes for Figure 13:

1. Drawings are not to scale.
2. All dimensions are in millimeters.

About Lumileds

Companies developing automotive, mobile, IoT and illumination lighting applications need a partner who can collaborate with them to push the boundaries of light. With over 100 years of inventions and industry firsts, Lumileds is a global lighting solutions company that helps customers around the world deliver differentiated solutions to gain and maintain a competitive edge. As the inventor of Xenon technology, a pioneer in halogen lighting and the leader in high performance LEDs, Lumileds builds innovation, quality and reliability into its technology, products and every customer engagement. Together with its customers, Lumileds is making the world better, safer, more beautiful—with light.

To learn more about our lighting solutions, visit lumileds.com.



©2018 Lumileds Holding B.V. All rights reserved.
LUXEON is a registered trademark of the Lumileds Holding B.V. in the United States and other countries.

lumileds.com

Neither Lumileds Holding B.V. nor its affiliates shall be liable for any kind of loss of data or any other damages, direct, indirect or consequential, resulting from the use of the provided information and data. Although Lumileds Holding B.V. and/or its affiliates have attempted to provide the most accurate information and data, the materials and services information and data are provided "as is," and neither Lumileds Holding B.V. nor its affiliates warrants or guarantees the contents and correctness of the provided information and data. Lumileds Holding B.V. and its affiliates reserve the right to make changes without notice. You as user agree to this disclaimer and user agreement with the download or use of the provided materials, information and data. A listing of Lumileds product/patent coverage may be accessed at lumileds.com/patents.

DS216 LUXEON 2835 Line
Product Datasheet 20181019

Downloaded From Oneyac.com

单击下面可查看定价，库存，交付和生命周期等信息

[>>Lumileds\(流明\)](#)