

# IRGR3B60KD2PbF

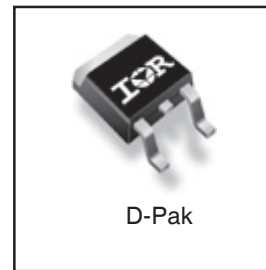
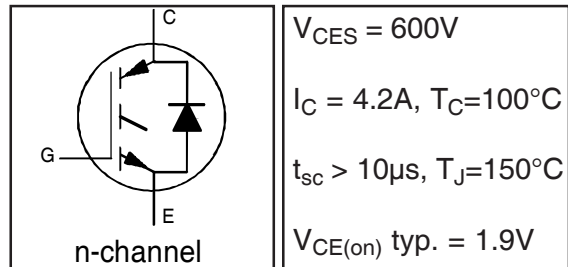
## INSULATED GATE BIPOLAR TRANSISTOR WITH ULTRAFAST SOFT RECOVERY DIODE

### Features

- Low VCE (on) Non Punch Through IGBT Technology.
- Low Diode VF.
- 10µs Short Circuit Capability.
- Square RBSOA.
- Ultrasoft Diode Reverse Recovery Characteristics.
- Positive VCE (on) Temperature Coefficient.
- Lead-Free

### Benefits

- Benchmark Efficiency for Motor Control.
- Rugged Transient Performance.
- Low EMI.
- Excellent Current Sharing in Parallel Operation.



### Absolute Maximum Ratings

	Parameter	Max.	Units
V <sub>CEs</sub>	Collector-to-Emitter Voltage	600	V
I <sub>C</sub> @ T <sub>C</sub> = 25°C	Continuous Collector Current	7.8	A
I <sub>C</sub> @ T <sub>C</sub> = 100°C	Continuous Collector Current	4.2	
I <sub>CM</sub>	Pulse Collector Current (Ref.Fig.C.T.5)	15.6	
I <sub>LM</sub>	Clamped Inductive Load current ①	15.6	
I <sub>F</sub> @ T <sub>C</sub> = 25°C	Diode Continuous Forward Current	6.0	
I <sub>F</sub> @ T <sub>C</sub> = 100°C	Diode Continuous Forward Current	3.2	
I <sub>FM</sub>	Diode Maximum Forward Current	15.6	
V <sub>GE</sub>	Gate-to-Emitter Voltage	±20	V
P <sub>D</sub> @ T <sub>C</sub> = 25°C	Maximum Power Dissipation	52	W
P <sub>D</sub> @ T <sub>C</sub> = 100°C	Maximum Power Dissipation	21	
T <sub>J</sub>	Operating Junction and	-55 to +150	°C
T <sub>STG</sub>	Storage Temperature Range		
	Soldering Temperature Range, for 10 sec.	300 (0.063 in. (1.6mm) from case)	

### Thermal / Mechanical Characteristics

	Parameter	Min.	Typ.	Max.	Units
R <sub>θJC</sub>	Junction-to-Case- IGBT	—	—	2.4	°C/W
R <sub>θJC</sub>	Junction-to-Case- Diode	—	—	8.8	
R <sub>θJA</sub>	Junction-to-Ambient, (PCB Mount) ②	—	—	50	
Wt	Weight	—	0.3	—	g

# IRGR3B60KD2PbF

International  
IR Rectifier

## Electrical Characteristics @ T<sub>J</sub> = 25°C (unless otherwise specified)

	Parameter	Min.	Typ.	Max.	Units	Conditions	Ref.Fig.
V <sub>(BR)CES</sub>	Collector-to-Emitter Breakdown Voltage	600	—	—	V	V <sub>GE</sub> = 0V, I <sub>C</sub> = 500μA	
ΔV <sub>(BR)CES</sub> /ΔT <sub>J</sub>	Temperature Coeff. of Breakdown Voltage	—	0.32	—	V/°C	V <sub>GE</sub> = 0V, I <sub>C</sub> = 1mA (25°C-150°C)	
V <sub>CE(on)</sub>	Collector-to-Emitter Voltage	—	1.9	2.4	V	I <sub>C</sub> = 3.0A, V <sub>GE</sub> = 15V	5,6,7
		—	2.2	2.6		I <sub>C</sub> = 3.0A, V <sub>GE</sub> = 15V, T <sub>J</sub> = 150°C	9,10,11
V <sub>GE(th)</sub>	Gate Threshold Voltage	3.5	4.5	5.5	mV/°C	V <sub>CE</sub> = V <sub>GE</sub> , I <sub>C</sub> = 250μA	9,10,11
ΔV <sub>GE(th)</sub> /ΔT <sub>J</sub>	Threshold Voltage temp. coefficient	—	-8.5	—		V <sub>CE</sub> = V <sub>GE</sub> , I <sub>C</sub> = 1mA (25°C-150°C)	12
g <sub>f</sub>	Forward Transconductance	—	1.9	—	S	V <sub>CE</sub> = 50V, I <sub>C</sub> = 3.0A, PW = 80μs	
I <sub>CES</sub>	Zero Gate Voltage Collector Current	—	1.0	150	μA	V <sub>GE</sub> = 0V, V <sub>CE</sub> = 600V	
		—	200	500		V <sub>GE</sub> = 0V, V <sub>CE</sub> = 600V, T <sub>J</sub> = 150°C	
V <sub>FM</sub>	Diode Forward Voltage Drop	—	1.5	1.8	V	I <sub>F</sub> = 3.0A, V <sub>GE</sub> = 0V	8
		—	1.5	1.8		I <sub>F</sub> = 3.0A, V <sub>GE</sub> = 0V, T <sub>J</sub> = 150°C	
I <sub>GES</sub>	Gate-to-Emitter Leakage Current	—	—	±100	nA	V <sub>GE</sub> = ±20V, V <sub>CE</sub> = 0V	

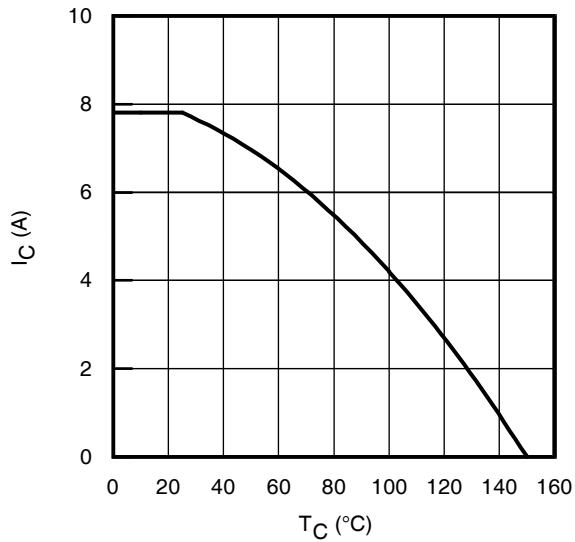
## Switching Characteristics @ T<sub>J</sub> = 25°C (unless otherwise specified)

	Parameter	Min.	Typ.	Max.	Units	Conditions	Ref.Fig.
Q <sub>g</sub>	Total Gate Charge (turn-on)	—	13	20	nC	I <sub>C</sub> = 3.0A	23
Q <sub>ge</sub>	Gate-to-Emitter Charge (turn-on)	—	1.5	2.3		V <sub>CC</sub> = 400V	CT1
Q <sub>gc</sub>	Gate-to-Collector Charge (turn-on)	—	6.6	9.9		V <sub>GE</sub> = 15V	
E <sub>on</sub>	Turn-On Switching Loss	—	62	75	μJ	I <sub>C</sub> = 3.0A, V <sub>CC</sub> = 400V	CT4
E <sub>off</sub>	Turn-Off Switching Loss	—	39	50		V <sub>GE</sub> = 15V, R <sub>G</sub> = 100Ω, L = 2.5mH	
E <sub>tot</sub>	Total Switching Loss	—	100	120		T <sub>J</sub> = 25°C ③	
t <sub>d(on)</sub>	Turn-On delay time	—	18	22	ns	I <sub>C</sub> = 3.0A, V <sub>CC</sub> = 400V	CT4
t <sub>r</sub>	Rise time	—	15	21		V <sub>GE</sub> = 15V, R <sub>G</sub> = 100Ω, L = 2.5mH	
t <sub>d(off)</sub>	Turn-Off delay time	—	110	120		T <sub>J</sub> = 25°C	
t <sub>f</sub>	Fall time	—	68	80			
E <sub>on</sub>	Turn-On Switching Loss	—	91	100		I <sub>C</sub> = 3.0A, V <sub>CC</sub> = 400V	
E <sub>off</sub>	Turn-Off Switching Loss	—	98	140	μJ	V <sub>GE</sub> = 15V, R <sub>G</sub> = 100Ω, L = 2.5mH	13,15
E <sub>tot</sub>	Total Switching Loss	—	190	230		T <sub>J</sub> = 150°C ③	WF1,WF2
t <sub>d(on)</sub>	Turn-On delay time	—	18	22		I <sub>C</sub> = 3.0A, V <sub>CC</sub> = 400V	14,16
t <sub>r</sub>	Rise time	—	17	22	ns	V <sub>GE</sub> = 15V, R <sub>G</sub> = 100Ω, L = 2.5mH	CT4
t <sub>d(off)</sub>	Turn-Off delay time	—	120	140		T <sub>J</sub> = 150°C	WF1
t <sub>f</sub>	Fall time	—	91	105			WF2
C <sub>ies</sub>	Input Capacitance	—	190	—	pF	V <sub>GE</sub> = 0V	22
C <sub>oes</sub>	Output Capacitance	—	23	—		V <sub>CC</sub> = 30V	
C <sub>res</sub>	Reverse Transfer Capacitance	—	6.6	—		f = 1.0MHz	
RBSOA	Reverse Bias Safe Operating Area	FULL SQUARE				T <sub>J</sub> = 150°C, I <sub>C</sub> = 15.6A, V <sub>p</sub> = 600V V <sub>CC</sub> =500V, V <sub>GE</sub> =+15V to 0V, R <sub>G</sub> = 100Ω	4 CT2
SCSOA	Short Circuit Safe Operating Area	10	—	—	μs	T <sub>J</sub> = 150°C, V <sub>p</sub> = 600V, R <sub>G</sub> = 100Ω V <sub>CC</sub> =360V, V <sub>GE</sub> = +15V to 0V	CT3 WF4
E <sub>rec</sub>	Reverse Recovery Energy of the Diode	—	38	44	μJ	T <sub>J</sub> = 150°C	17,18,19
t <sub>rr</sub>	Diode Reverse Recovery Time	—	77	84	ns	V <sub>CC</sub> = 400V, I <sub>F</sub> = 3.0A, L = 2.5mH	20,21
I <sub>rr</sub>	Diode Peak Reverse Recovery Current	—	4.8	5.3	A	V <sub>GE</sub> = 15V, R <sub>G</sub> = 100Ω	CT4,WF3

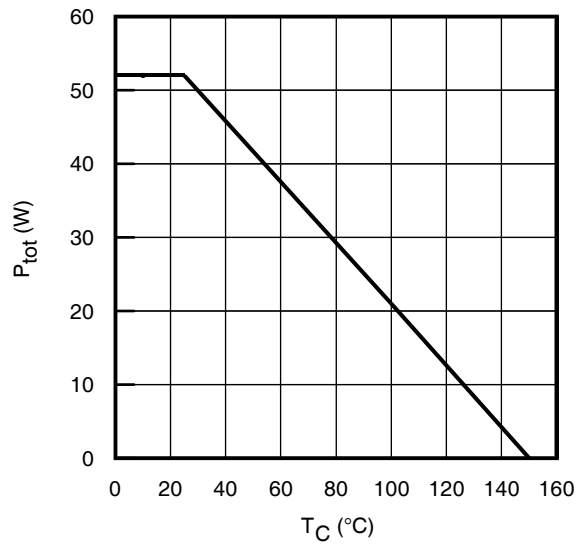
① V<sub>CC</sub> = 80% (V<sub>CES</sub>), V<sub>GE</sub> = 15V, L = 100μH, R<sub>G</sub> = 100Ω.

③ Energy losses include "tail" and diode reverse recovery.

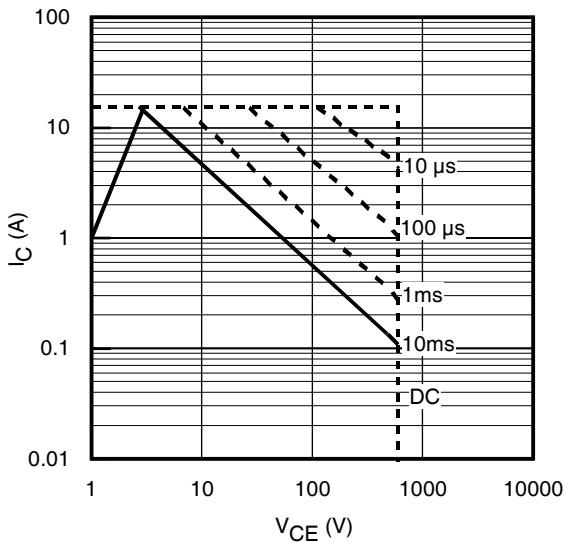
② When mounted on 1" square PCB (FR-4 or G-10 Material) . For recommended footprint and soldering techniques refer to application note #AN-994.



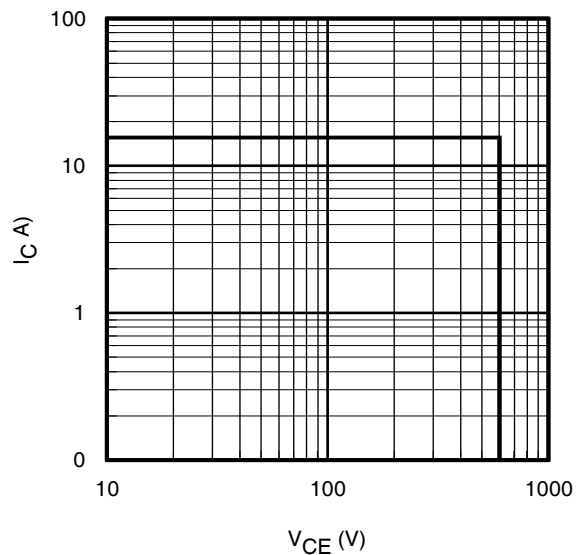
**Fig. 1** - Maximum DC Collector Current vs. Case Temperature



**Fig. 2** - Power Dissipation vs. Case Temperature

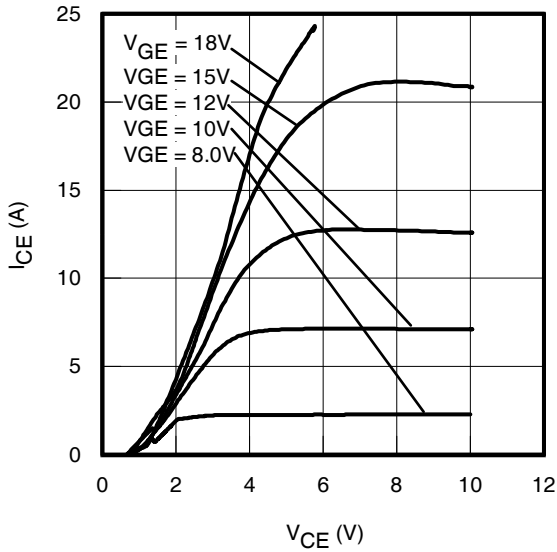


**Fig. 3** - Forward SOA  
 $T_C = 25^{\circ}C$ ;  $T_J \leq 150^{\circ}C$

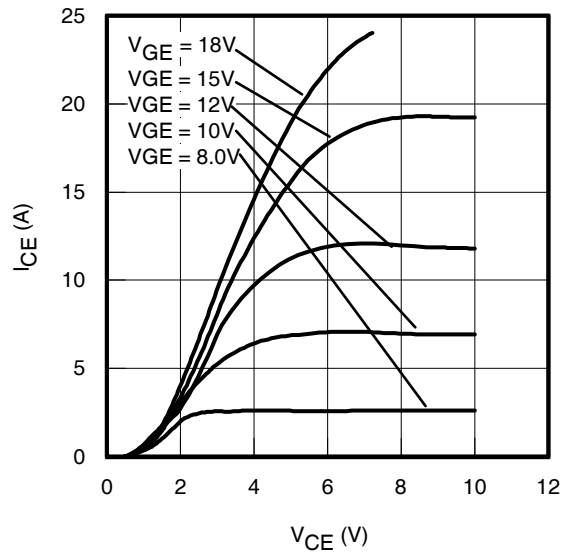


**Fig. 4** - Reverse Bias SOA  
 $T_J = 150^{\circ}C$ ;  $V_{GE} = 15V$

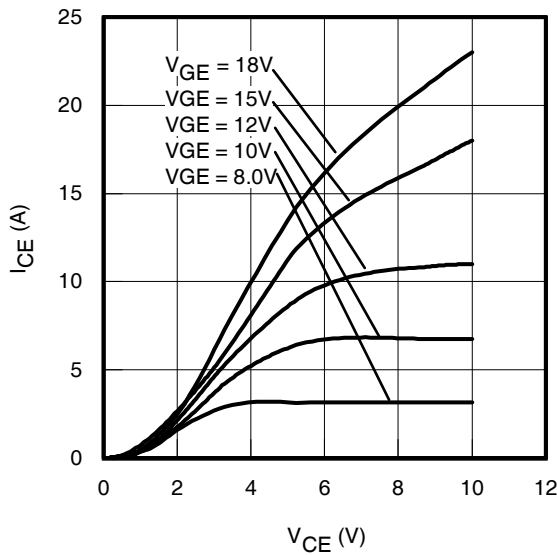
# IRGR3B60KD2PbF



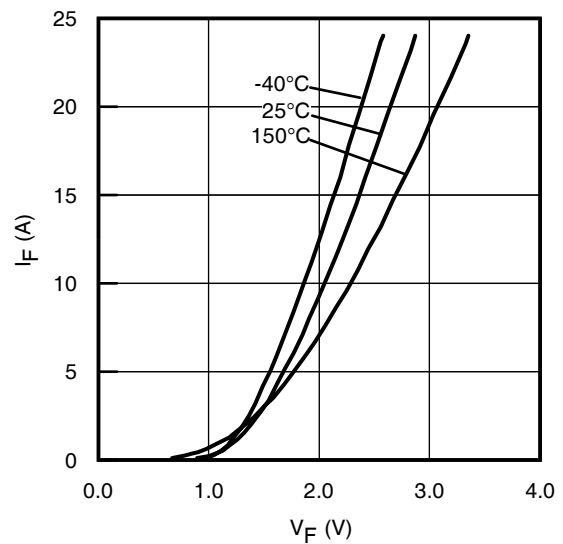
**Fig. 5** - Typ. IGBT Output Characteristics  
 $T_J = -40^\circ\text{C}$ ;  $t_p = 80\mu\text{s}$



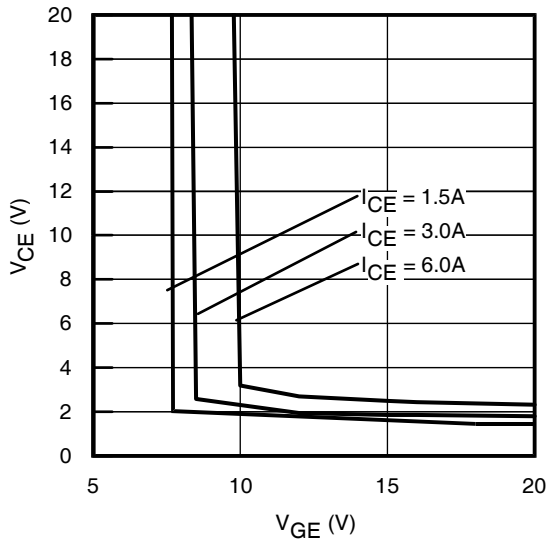
**Fig. 6** - Typ. IGBT Output Characteristics  
 $T_J = 25^\circ\text{C}$ ;  $t_p = 80\mu\text{s}$



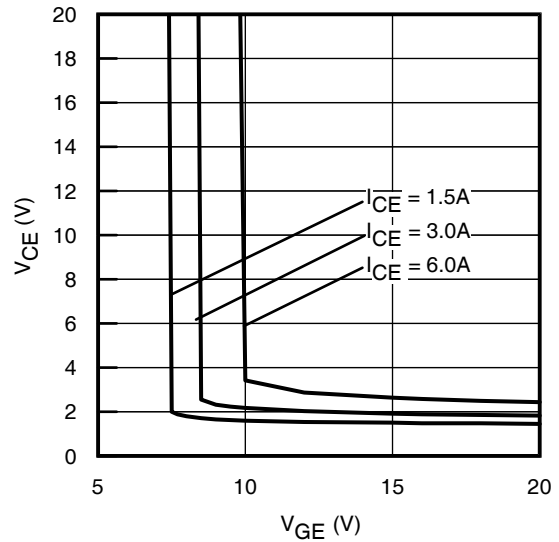
**Fig. 7** - Typ. IGBT Output Characteristics  
 $T_J = 150^\circ\text{C}$ ;  $t_p = 80\mu\text{s}$



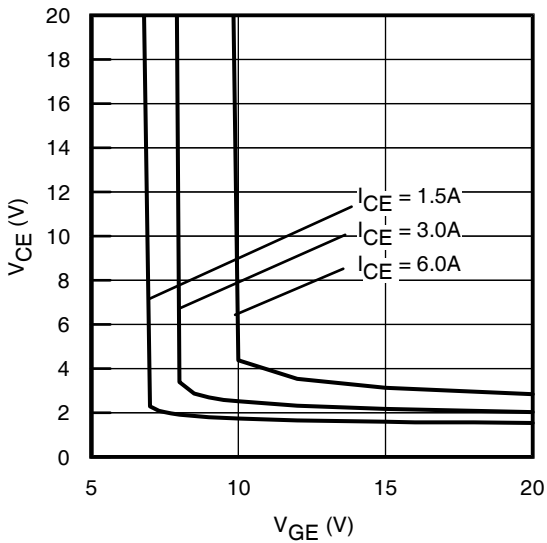
**Fig. 8** - Typ. Diode Forward Characteristics  
 $t_p = 80\mu\text{s}$



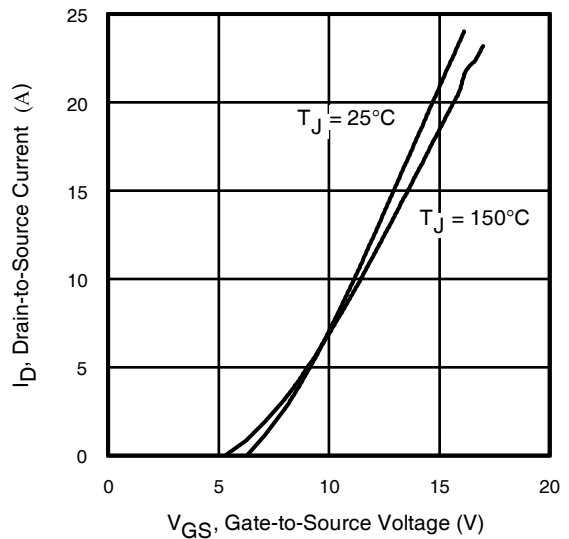
**Fig. 9** - Typical  $V_{CE}$  vs.  $V_{GE}$   
 $T_J = -40^\circ\text{C}$



**Fig. 10** - Typical  $V_{CE}$  vs.  $V_{GE}$   
 $T_J = 25^\circ\text{C}$

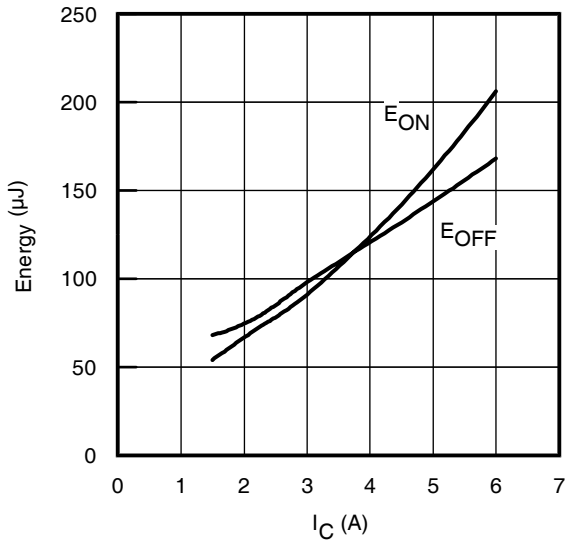


**Fig. 11** - Typical  $V_{CE}$  vs.  $V_{GE}$   
 $T_J = 150^\circ\text{C}$

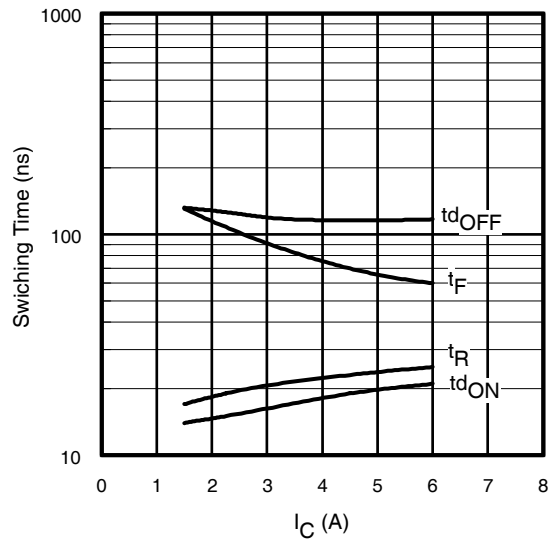


**Fig. 12** - Typ. Transfer Characteristics  
 $V_{CE} = 50\text{V}$ ;  $t_p = 10\mu\text{s}$

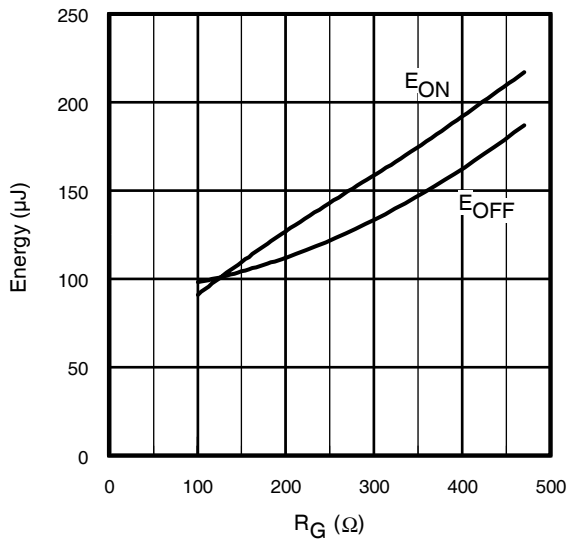
# IRGR3B60KD2PbF



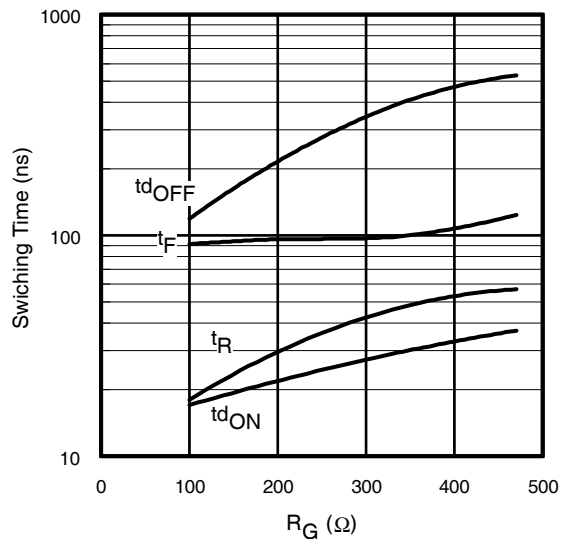
**Fig. 13** - Typ. Energy Loss vs.  $I_C$   
 $T_J = 150^\circ\text{C}$ ;  $L = 2.5\text{mH}$ ;  $V_{CE} = 400\text{V}$   
 $R_G = 100\Omega$ ;  $V_{GE} = 15\text{V}$



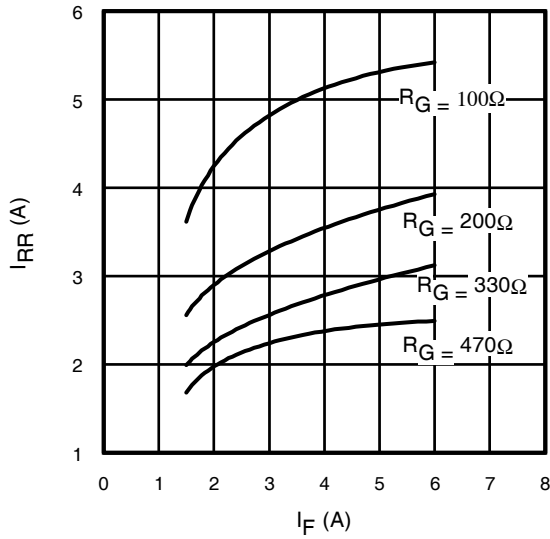
**Fig. 14** - Typ. Switching Time vs.  $I_C$   
 $T_J = 150^\circ\text{C}$ ;  $L = 2.5\text{mH}$ ;  $V_{CE} = 400\text{V}$   
 $R_G = 100\Omega$ ;  $V_{GE} = 15\text{V}$



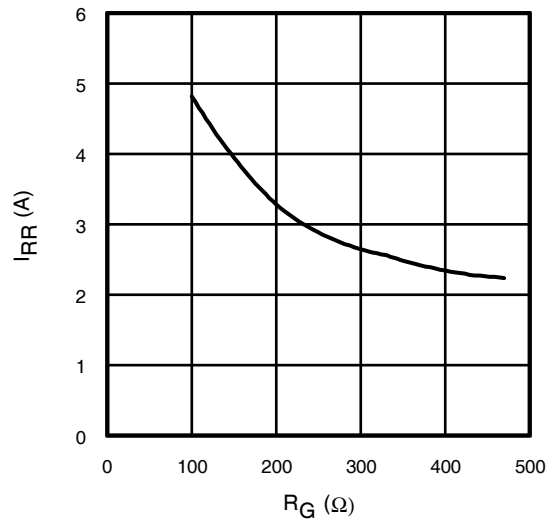
**Fig. 15** - Typ. Energy Loss vs.  $R_G$   
 $T_J = 150^\circ\text{C}$ ;  $L = 2.5\text{mH}$ ;  $V_{CE} = 400\text{V}$   
 $I_{CE} = 3.0\text{A}$ ;  $V_{GE} = 15\text{V}$



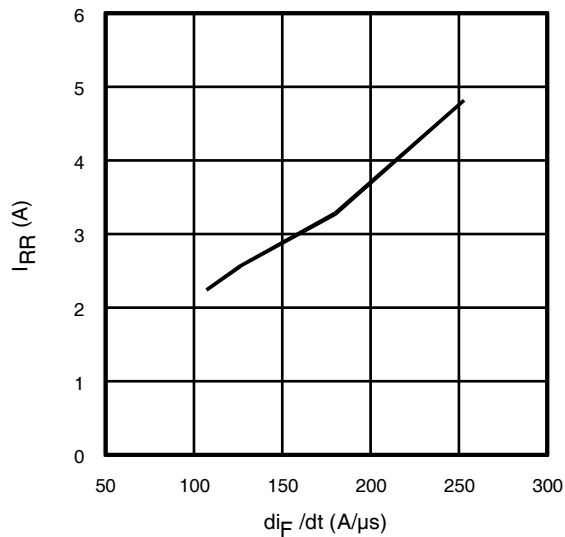
**Fig. 16** - Typ. Switching Time vs.  $R_G$   
 $T_J = 150^\circ\text{C}$ ;  $L = 2.5\text{mH}$ ;  $V_{CE} = 400\text{V}$   
 $I_{CE} = 3.0\text{A}$ ;  $V_{GE} = 15\text{V}$



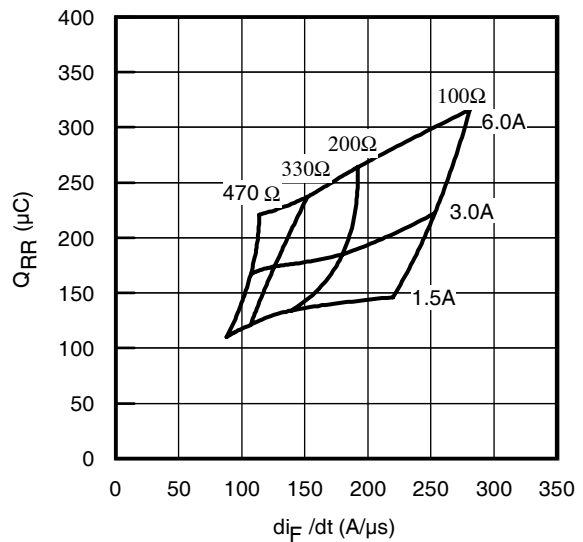
**Fig. 17** - Typical Diode  $I_{RR}$  vs.  $I_F$   
 $T_J = 150^\circ\text{C}$



**Fig. 18** - Typical Diode  $I_{RR}$  vs.  $R_G$   
 $T_J = 150^\circ\text{C}; I_F = 3.0\text{A}$

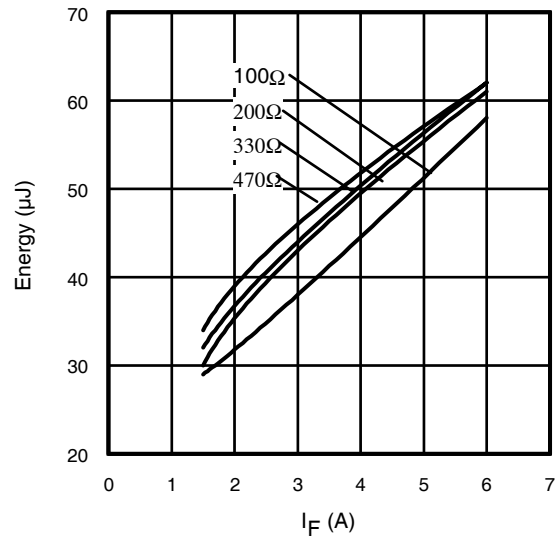


**Fig. 19**- Typical Diode  $I_{RR}$  vs.  $di_F/dt$   
 $V_{CC} = 400\text{V}; V_{GE} = 15\text{V};$   
 $I_F = 3.0\text{A}; T_J = 150^\circ\text{C}$

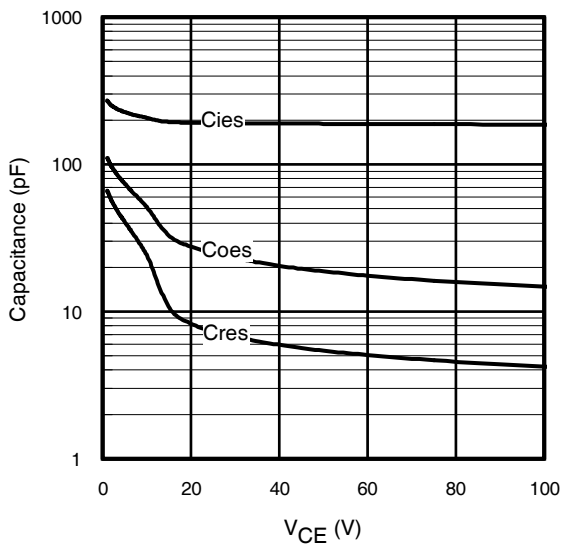


**Fig. 20** - Typical Diode  $Q_{RR}$   
 $V_{CC} = 400\text{V}; V_{GE} = 15\text{V}; T_J = 150^\circ\text{C}$

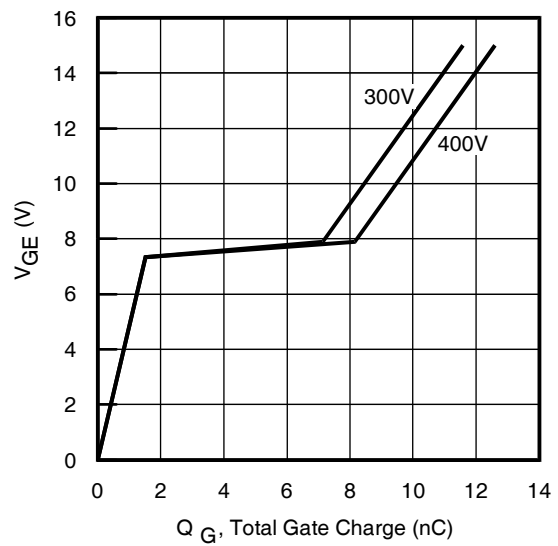
# IRGR3B60KD2PbF



**Fig. 21** - Typical Diode  $E_{RR}$  vs.  $I_F$   
 $T_J = 150^\circ\text{C}$



**Fig. 22**- Typ. Capacitance vs.  $V_{CE}$   
 $V_{GE} = 0\text{V}$ ;  $f = 1\text{MHz}$



**Fig. 23** - Typical Gate Charge vs.  $V_{GE}$   
 $I_{CE} = 3.0\text{A}$ ;  $L = 600\mu\text{H}$



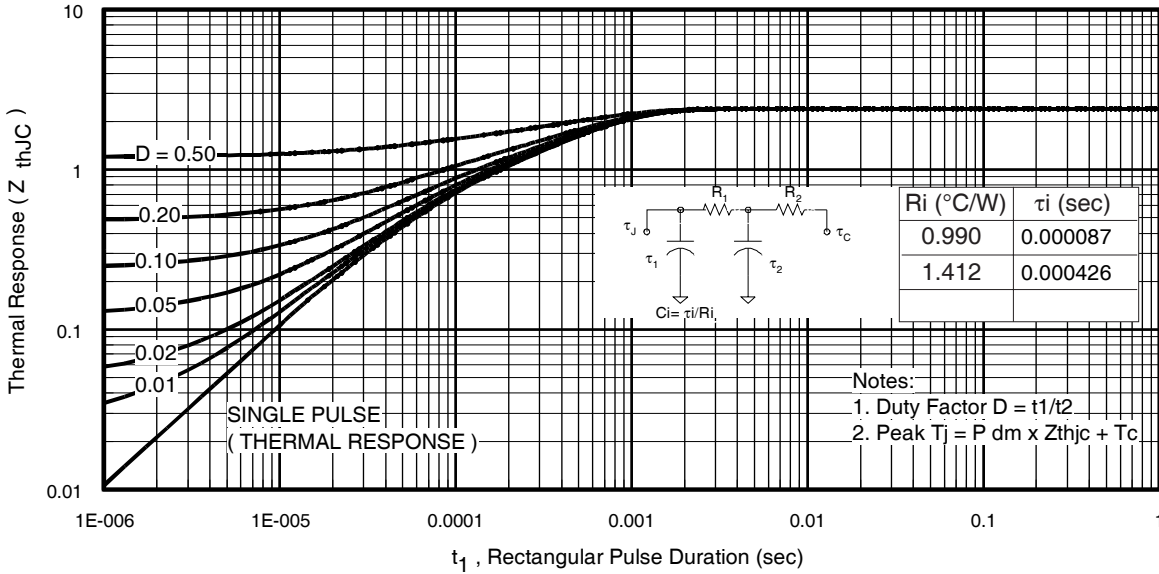


Fig 24. Maximum Transient Thermal Impedance, Junction-to-Case (IGBT)

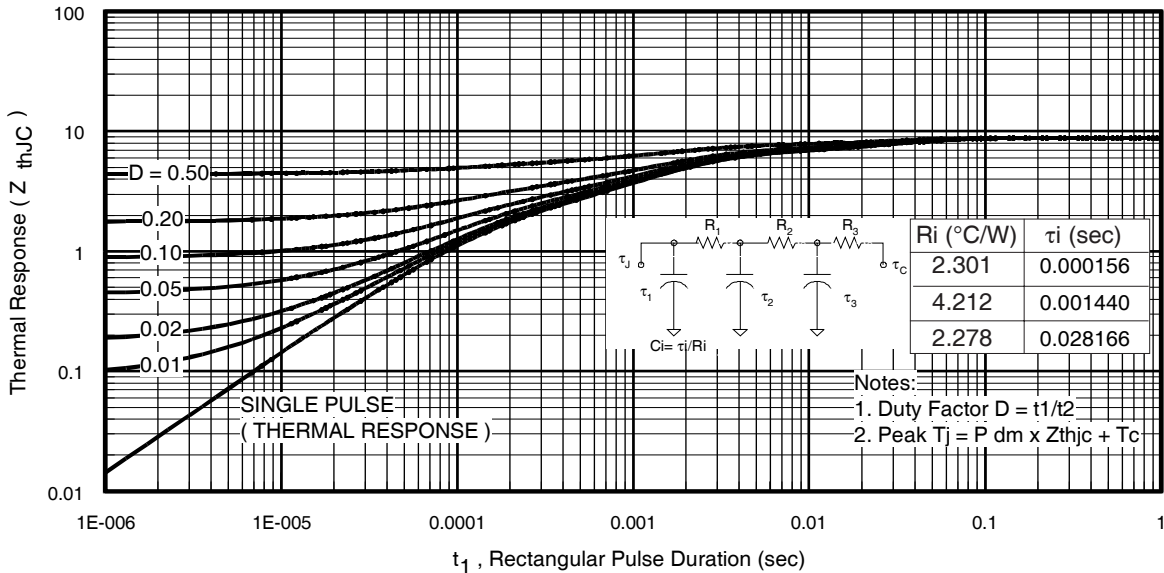
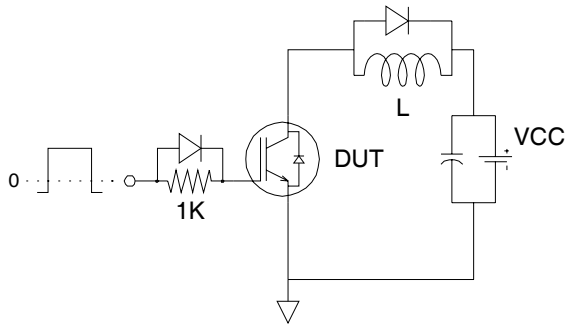


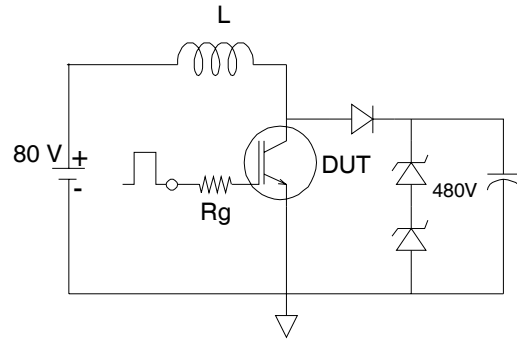
Fig 25. Maximum Transient Thermal Impedance, Junction-to-Case (DIODE)

# IRGR3B60KD2PbF

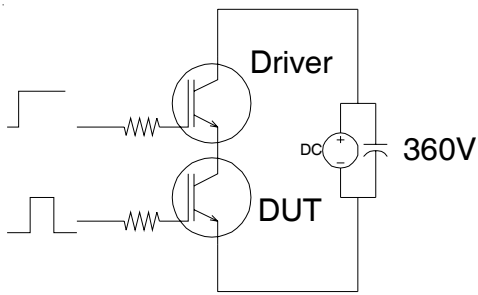
International  
**IR** Rectifier



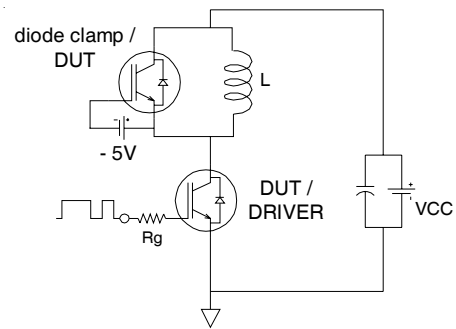
**Fig.C.T.1** - Gate Charge Circuit (turn-off)



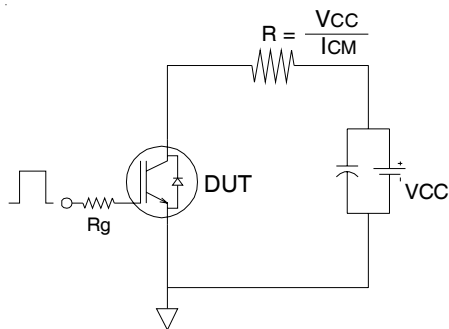
**Fig.C.T.2** - RBSOA Circuit



**Fig.C.T.3** - S.C.SOA Circuit



**Fig.C.T.4** - Switching Loss Circuit



**Fig.C.T.5** - Resistive Load Circuit

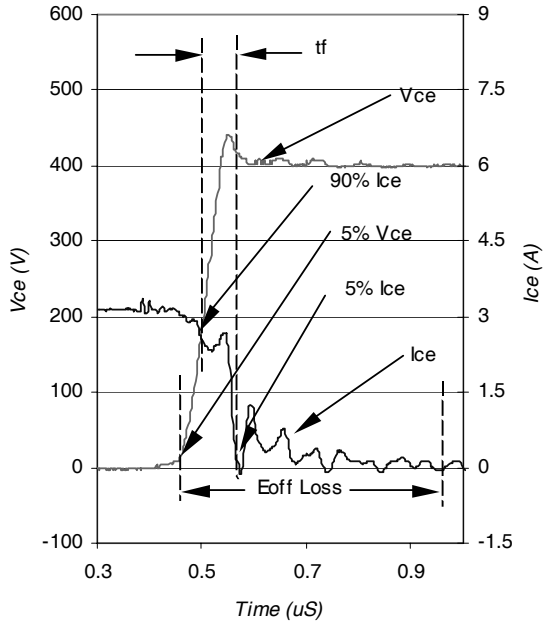


Fig. WF1- Typ. Turn-off Loss Waveform  
 @  $T_J = 150^\circ\text{C}$  using Fig. CT.4

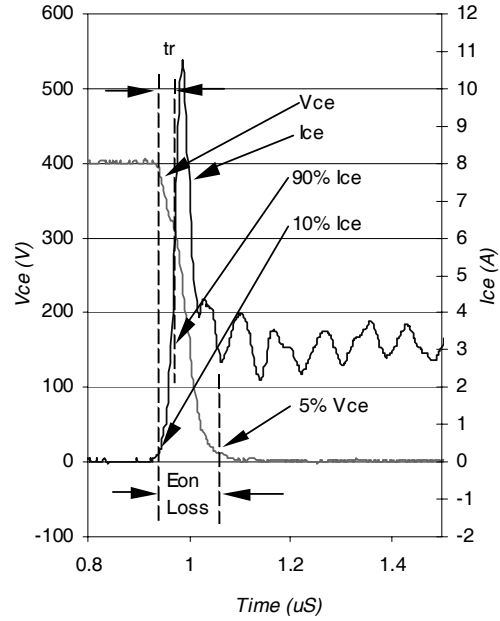


Fig. WF2- Typ. Turn-on Loss Waveform  
 @  $T_J = 150^\circ\text{C}$  using Fig. CT.4

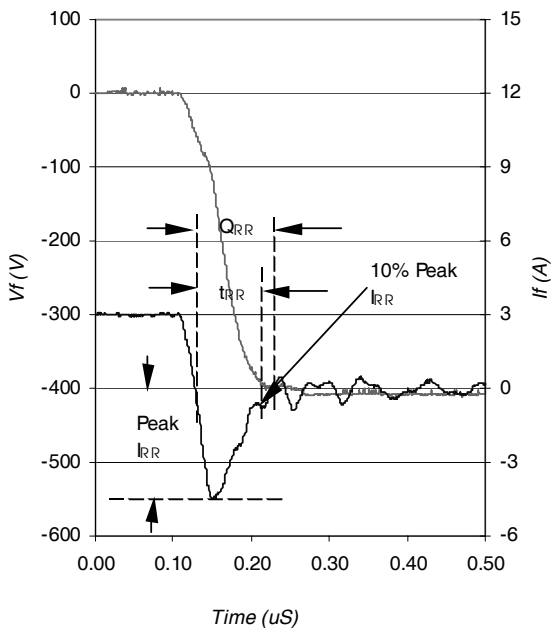


Fig. WF3- Typ. Diode Recovery Waveform  
 @  $T_J = 150^\circ\text{C}$  using Fig. CT.4

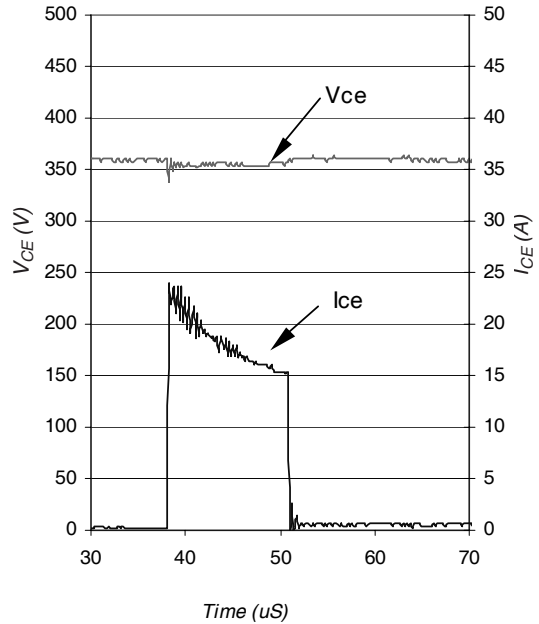
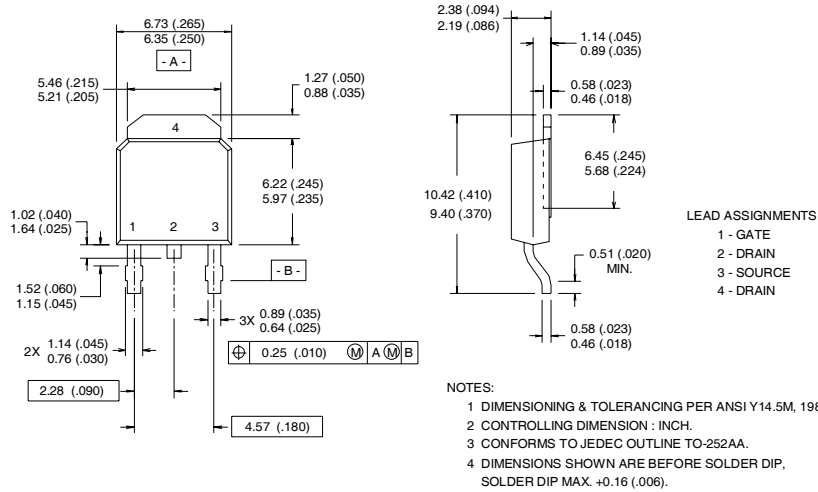


Fig. WF4- Typ. S.C Waveform  
 @  $T_C = 150^\circ\text{C}$  using Fig. CT.3

# IRGR3B60KD2PbF

## D-Pak (TO-252AA) Package Outline

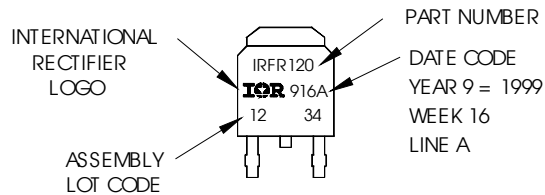
Dimensions are shown in millimeters (inches)



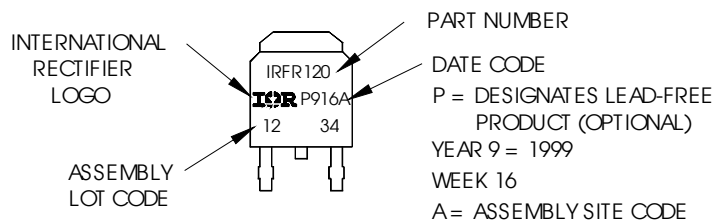
## D-Pak (TO-252AA) Part Marking Information (Lead-Free)

EXAMPLE: THIS IS AN IRFR120  
WITH ASSEMBLY  
LOT CODE 1234  
ASSEMBLED ON WW 16, 1999  
IN THE ASSEMBLY LINE "A"

Note: "P" in assembly line  
position indicates "Lead-Free"

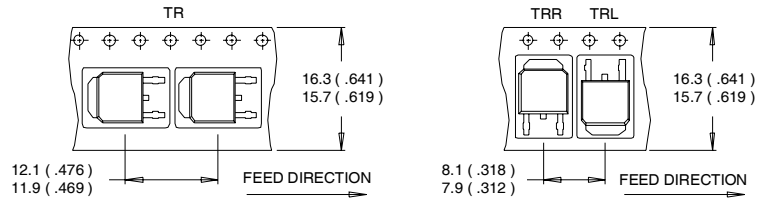


**OR**

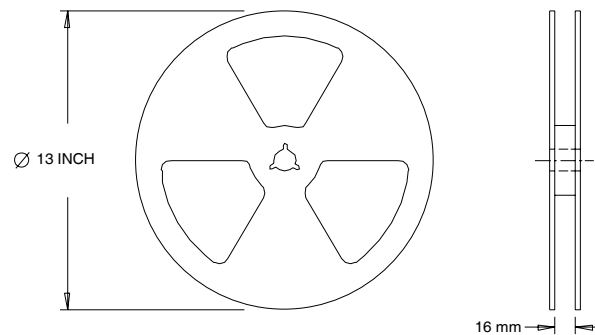


## D-Pak (TO-252AA) Tape & Reel Information

Dimensions are shown in millimeters (inches)



- NOTES :
1. CONTROLLING DIMENSION : MILLIMETER.
  2. ALL DIMENSIONS ARE SHOWN IN MILLIMETERS ( INCHES ).
  3. OUTLINE CONFORMS TO EIA-481 & EIA-541.



- NOTES :
1. OUTLINE CONFORMS TO EIA-481.

Data and specifications subject to change without notice.  
 This product has been designed and qualified for the Industrial market.  
 Qualification Standards can be found on IR's Web site.

Note: For the most current drawings please refer to the IR website at:  
<http://www.irf.com/package/>

单击下面可查看定价，库存，交付和生命周期等信息

[>>Infineon Technologies\(英飞凌\)](#)

[>>点击查看相关商品](#)