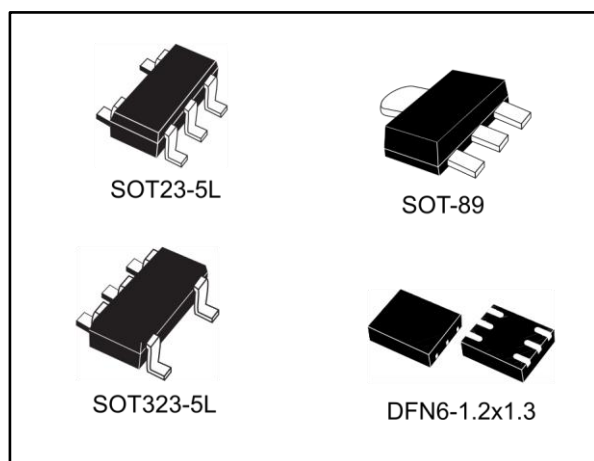

200 mA low quiescent current and low noise LDO

Datasheet - production data

**Applications**

- Battery-powered equipment
- TV
- Set-top box
- PC and laptop
- Industrial

Description

The LDK220 is a low drop voltage regulator, which provides a maximum output current of 200 mA from an input voltage in the range of 2.5 V to 13.2 V, with a typical dropout voltage of 100 mV.

A ceramic capacitor stabilizes it on the output.

The very low drop voltage, low quiescent current and low noise make it suitable for battery-powered applications.

The enable logic control function puts the LDK220 in shutdown mode allowing a total current consumption lower than 1 μ A.

The device also includes a short-circuit constant current limiting and thermal protection.

Features

- Input voltage from 2.5 to 13.2 V
- Very low-dropout voltage (100 mV typ. @ 100 mA load)
- Low quiescent current (typ. 55 μ A, 1 μ A in off mode)
- Low noise
- Output voltage tolerance: $\pm 2.0\%$ @ 25 $^{\circ}$ C
- 200 mA guaranteed output current
- Wide range of output voltages available on request: fixed from 1.2 V to 12 V with 100 mV step and adjustable
- Logic-controlled electronic shutdown
- Compatible with ceramic capacitor
 $C_{OUT} = 1 \mu$ F
- Internal current and thermal limit
- Available in SOT23-5L, SOT323-5L, SOT-89 and DFN6-1.2x1.3 packages
- Temperature range: -40 $^{\circ}$ C to 125 $^{\circ}$ C

Contents

1	Diagram	3
2	Pin configuration	4
3	Typical application	5
4	Maximum ratings	6
5	Electrical characteristics	7
6	Typical performance characteristics	10
7	Package information	15
	7.1 SOT23-5L package information	15
	7.2 SOT23-5L packing information.....	17
	7.3 SOT-89 package information	18
	7.4 SOT-89 packing information.....	21
	7.5 SOT323-5L package information	22
	7.6 DFN6 1.2x1.3 package information.....	24
8	Ordering information	26
9	Revision history	27

2 Pin configuration

Figure 3: Pin connections (top view)

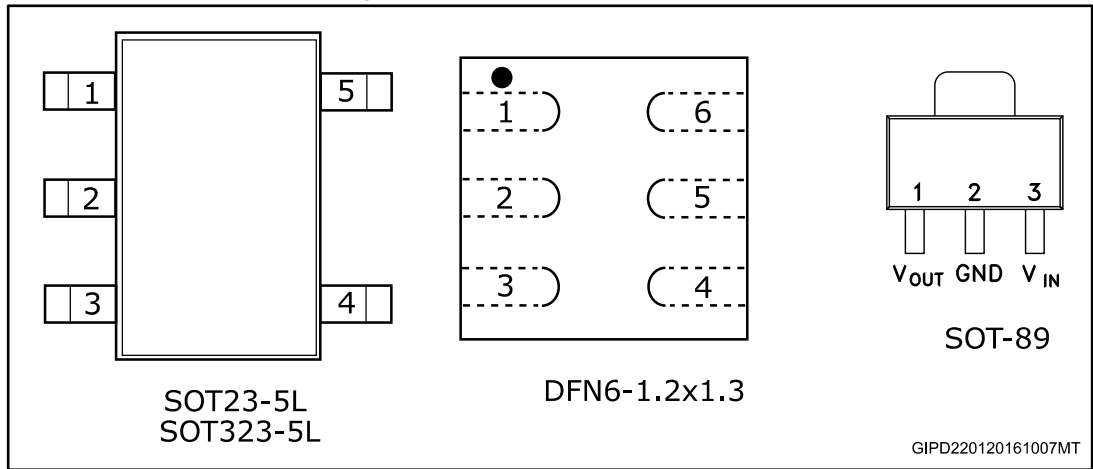

Table 1: Pin description (SOT23-5L, SOT323-5L)

Pin n°	Symbol	Function
1	IN	Input voltage of the LDO
2	GND	Common ground
3	EN	Enable pin logic input: low = shutdown, high = active
4	ADJ/NC	Adjustable pin on ADJ version, not connected on fixed version
5	OUT	Output voltage of the LDO

Table 2: Pin description (DFN6)

Pin n°	Symbol	Function
1	OUT	Output voltage of the LDO
2	N/C	Not connected
3	ADJ/NC	Adjustable pin on ADJ version, not connected in fixed version
4	EN	Enable pin logic input: low = shutdown, high = active
5	GND	Common ground
6	IN	Input voltage of the LDO

Table 3: Pin description (SOT-89)

Pin n° ⁽¹⁾	Symbol	Function
1	OUT	Output voltage of the LDO
2	GND	Common ground
3	IN	Input voltage of the LDO

Notes:

⁽¹⁾ Adjustable version and enable pin are not available on the SOT-89 package.

3 Typical application

Figure 4: Typical application circuits

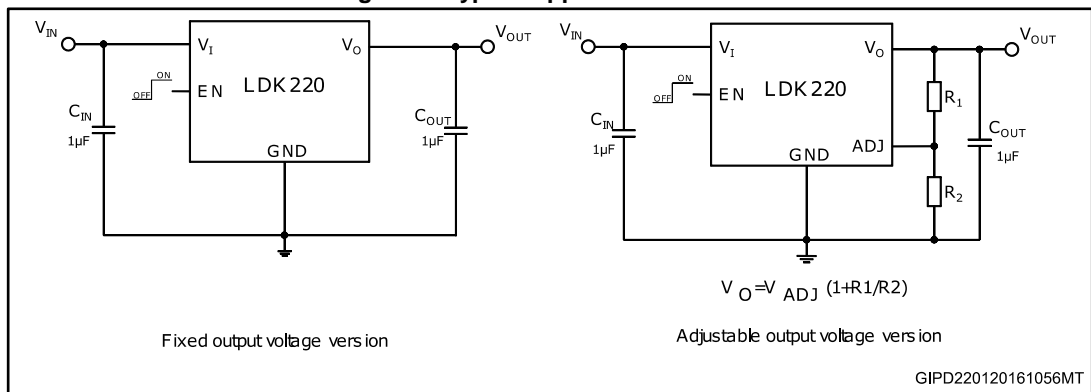

Adjustable version and enable pin are not available on the SOT-89 package.

4 Maximum ratings

Table 4: Absolute maximum ratings

Symbol	Parameter	Value	Unit
V_{IN}	DC input voltage	- 0.3 to 14	V
V_{OUT}	DC output voltage	- 0.3 to $V_I + 0.3$	V
V_{EN}	Enable input voltage	- 0.3 to $V_I + 0.3$	V
V_{ADJ}	ADJ pin voltage	- 0.3 to 2	V
I_{OUT}	Output current	Internally limited	mA
$P_D^{(1)}$	Power dissipation	500	mW
T_{STG}	Storage temperature range	- 65 to 150	°C
T_{OP}	Operating junction temperature range	- 40 to 125	°C

Notes:

⁽¹⁾ Maximum power dissipation has to be calculated taking into account the package thermal performance.



Absolute maximum ratings are those values beyond which damage to the device may occur. Functional operation under these conditions is not implied. All values are referred to GND.

Table 5: Thermal data

Symbol	Parameter	SOT23-5L	SOT323-5L	SOT-89	DFN-6	Unit
R_{thJA}	Thermal resistance junction-ambient	160	246	110	237	°C/W
R_{thJC}	Thermal resistance junction-case	68	134	15	104	°C/W

5 Electrical characteristics

$T_J = 25\text{ °C}$, $V_{IN} = V_{OUT(NOM)} + 1\text{ V}$, $C_{IN} = C_{OUT} = 1\text{ }\mu\text{F}$, $I_{OUT} = 1\text{ mA}$, $V_{EN} = V_{IN}$, unless otherwise specified.

Table 6: LDK220 electrical characteristics for fixed output version

Symbol	Parameter	Test conditions	Min.	Typ.	Max.	Unit
V_{IN}	Operating input voltage		2.5		13.2	V
V_{OUT}	V_{OUT} accuracy	$I_{OUT} = 1\text{ mA}$, $T_J = 25\text{ °C}$	-2		2	%
		$I_{OUT} = 1\text{ mA}$, $-40\text{ °C} < T_J < 125\text{ °C}$	-3		3	%
ΔV_{OUT}	Static line regulation	$V_{OUT} + 1\text{ V} \leq V_{IN} \leq 13.2\text{ V}$, $I_{OUT} = 1\text{ mA}$		0.001	0.05	%/V
ΔV_{OUT}	Static load regulation	$I_{OUT} = 1\text{ mA}$ to 200 mA		0.001	0.003	%/mA
V_{DROP}	Dropout voltage ⁽¹⁾	$I_{OUT} = 100\text{ mA}$, $V_{OUT} = 3.3\text{ V}$		100		mV
		$I_{OUT} = 200\text{ mA}$, $V_{OUT} = 3.3\text{ V}$ $40\text{ °C} < T_J < 125\text{ °C}$		200	350	
e_N	Output noise voltage	10 Hz to 100 kHz, $I_{OUT} = 10\text{ mA}$		20		$\mu\text{V}_{RMS}/\text{V}$
SVR	Supply voltage rejection	$V_{IN} = V_{OUT(NOM)} + 0.5\text{ V} + / - V_{RIPPLE}$ $V_{RIPPLE} = 0.1\text{ V}$ frequency = 120 Hz to 1 kHz $I_{OUT} = 10\text{ mA}$		55		dB
		$V_{IN} = V_{OUT(NOM)} + 0.5\text{ V} + / - V_{RIPPLE}$ $V_{RIPPLE} = 0.1\text{ V}$ frequency = 10 kHz $I_{OUT} = 10\text{ mA}$		50		
I_Q	Quiescent current	$V_{IN} = V_{OUT} + 1\text{ V}$ $I_{OUT} = 0\text{ mA}$, $-40\text{ °C} < T_J < 125\text{ °C}$		55	90	μA
		$V_{OUT} + 1\text{ V} \leq V_{IN} \leq 13.2\text{ V}$ ⁽²⁾ $I_{OUT} = 200\text{ mA}$, $-40\text{ °C} < T_J < 125\text{ °C}$		60	100	
		V_{IN} input current in off mode: $V_{EN} = \text{GND}$, $T_J = 25\text{ °C}$		0.1	1	
I_{SC}	Short-circuit current ⁽²⁾	$R_L = 0$		400		mA
V_{EN}	Enable input logic low	$V_{IN} = 2.5\text{ V}$ to 13.2 V , $-40\text{ °C} < T_J < 125\text{ °C}$			0.4	V
	Enable input logic high	$V_{IN} = 2.5\text{ V}$ to 13.2 V , $-40\text{ °C} < T_J < 125\text{ °C}$	1.2			
I_{EN}	Enable pin input current	$V_{EN} = V_{IN}$		0.1	100	nA

Symbol	Parameter	Test conditions	Min.	Typ.	Max.	Unit
T _{SHDN}	Thermal shutdown			160		°C
	Hysteresis			20		
C _{OUT}	Output capacitor	Capacitance (see Section 6: "Typical performance characteristics")	1		22	µF

Notes:

- (1) Dropout voltage is the input-to-output voltage difference at which the output voltage is 100 mV below its nominal value.
- (2) The maximum current has to be limited according to the maximum power dissipation.

T_J = 25 °C, V_{IN} = V_{OUT(NOM)} + 1 V, C_{IN} = C_{OUT} = 1 µF, I_{OUT} = 1 mA, V_{EN} = V_{IN}, unless otherwise specified.

Table 7: LDK220 electrical characteristics for adjustable version

Symbol	Parameter	Test conditions	Min.	Typ.	Max.	Unit
V _{IN}	Operating input voltage		2.5		13.2	V
V _{ADJ}	Adjustable voltage	T _J = 25 °C		1.185		V
	Adjustable voltage accuracy	T _J = 25 °C	-2		+2	%
40 °C < T _J < 125 °C		-3		+3		
ΔV _{OUT}	Static line regulation	V _{OUT} + 1 V ≤ V _{IN} ≤ 13.2 V I _{OUT} = 1 mA		0.001	0.05	%/V
ΔV _{OUT}	Static load regulation	I _{OUT} = 1 mA to 200 mA		0.0002	0.003	%/mA
V _{DROP}	Dropout voltage ⁽¹⁾	I _{OUT} = 100 mA, V _{OUT} = 3.3 V		100		mV
		I _{OUT} = 200 mA, V _{OUT} = 3.3 V 40 °C < T _J < 125 °C		200	350	
e _N	Output noise voltage	10 Hz to 100 kHz, I _{OUT} = 10 mA		100		µV _{RMS} /V
I _{ADJ}	Adjust pin current				1	µA
SVR	Supply voltage rejection	V _{IN} = V _{OUTNOM} + 0.5 V +/- V _{RIPPLE} V _{RIPPLE} = 0.1 V Frequency = 120 Hz to 1 kHz I _{OUT} = 10 mA		60		dB
		V _{RIPPLE} = 0.1 V V _{IN} = V _{OUTNOM} + 0.5 V +/- V _{RIPPLE} frequency = 10 kHz, I _{OUT} = 10 mA		45		



Symbol	Parameter	Test conditions	Min.	Typ.	Max.	Unit
I _Q	Quiescent current	V _{OUT} +1 V ≤ V _{IN} ≤ 13.2 V I _{OUT} = 0 mA, -40 °C < T _J < 125 °C		55	90	μA
		V _{OUT} +1 V ≤ V _{IN} ≤ 13.2 V ⁽²⁾ I _{OUT} = 200 mA, -40 °C < T _J < 125 °C		60	100	
		V _{IN} input current in off mode: V _{EN} = GND, T _J = 25 °C		0.1	1	
I _{SC}	Short-circuit current ⁽²⁾	R _L = 0		400		mA
V _{EN}	Enable input logic low	V _{IN} = 2.5 V to 13.2 V -40 °C < T _J < 125 °C			0.4	V
	Enable input logic high	V _{IN} = 2.5 V to 13.2 V -40 °C < T _J < 125 °C	1.2			
I _{EN}	Enable pin input current	V _{EN} = V _{IN}		0.1	100	nA
T _{SHDN}	Thermal shutdown			160		°C
	Hysteresis			20		
C _{OUT}	Output capacitor	Capacitance (see Section 6: "Typical performance characteristics")	1		22	μF

Notes:

⁽¹⁾ Dropout voltage is the input-to-output voltage difference at which the output voltage is 100 mV below its nominal value.

⁽²⁾ The maximum current has to be limited according to the maximum power dissipation.

6 Typical performance characteristics

($C_{IN} = C_{OUT} = 1 \mu F$, V_{EN} to V_{IN})

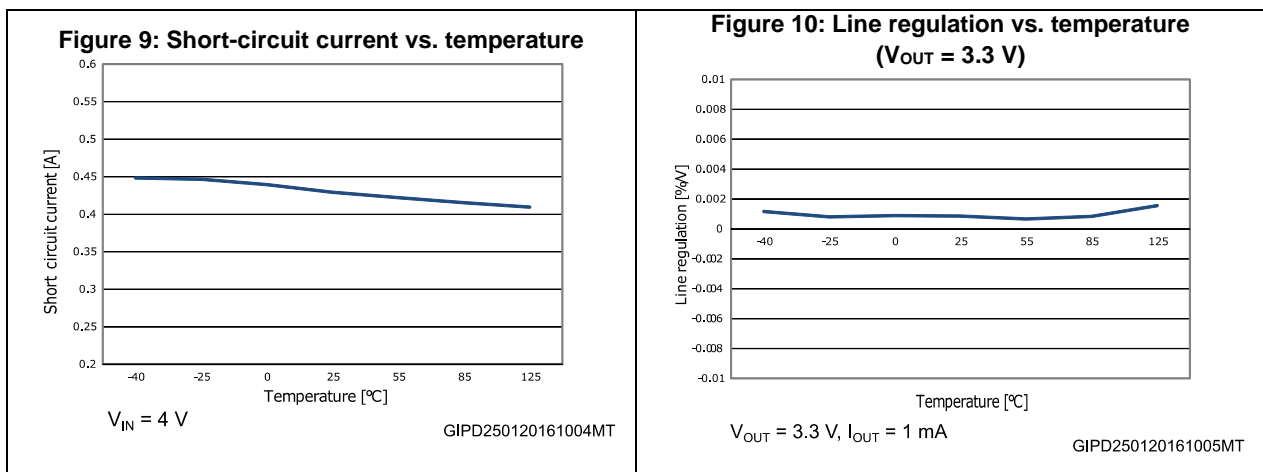
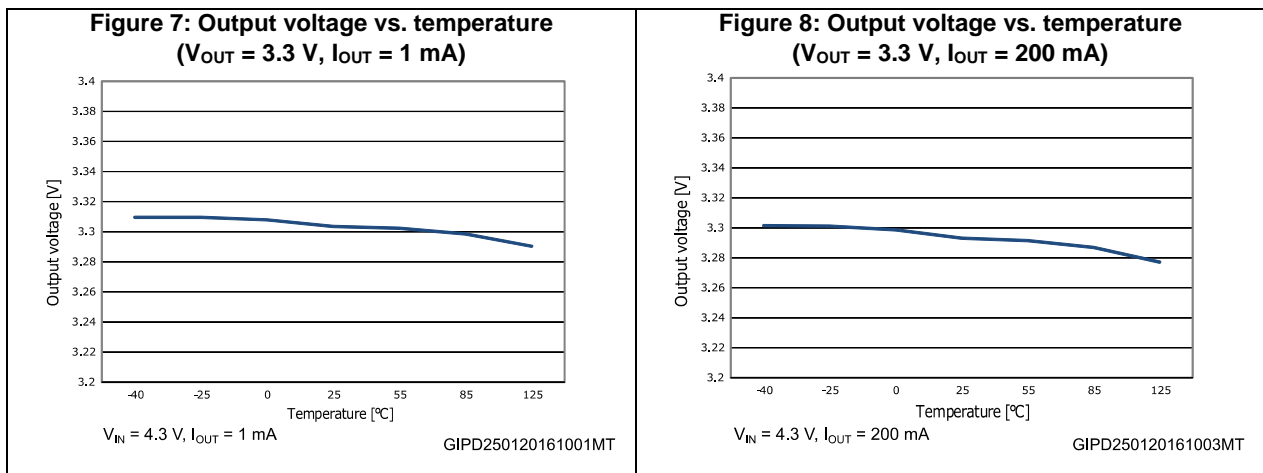
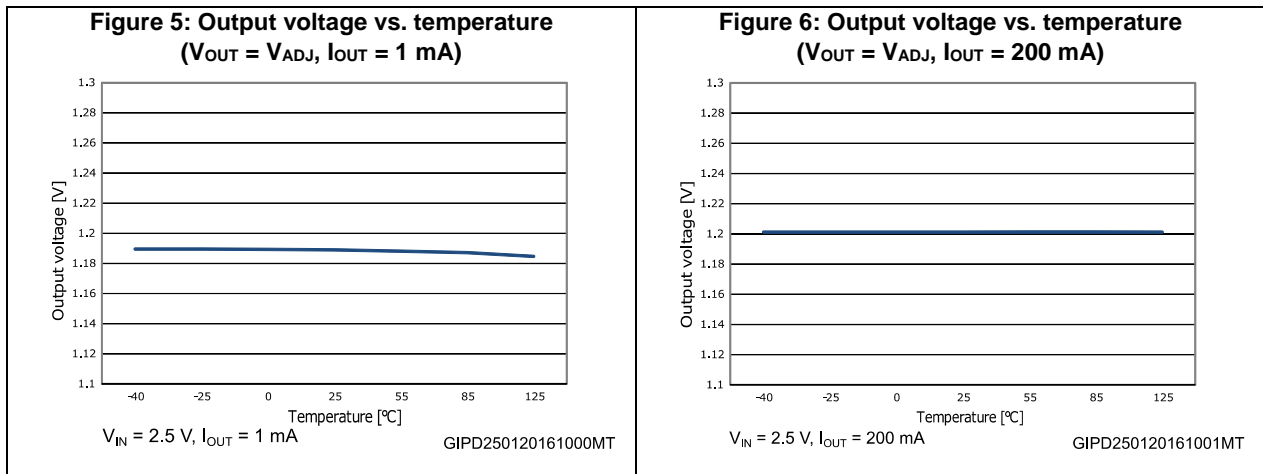

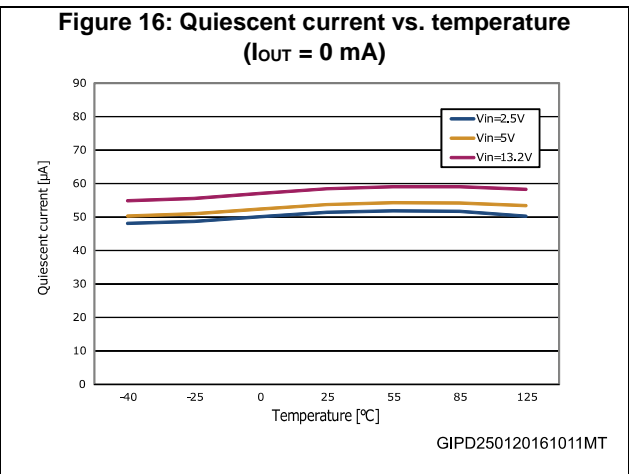
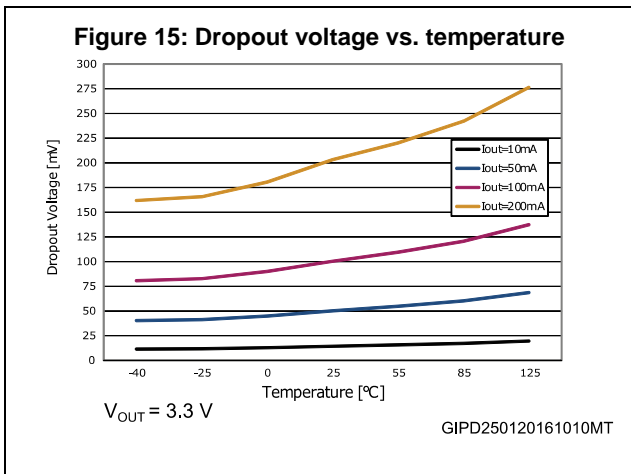
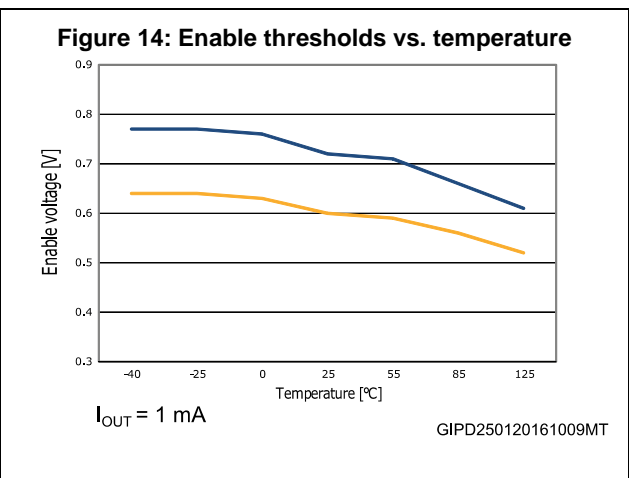
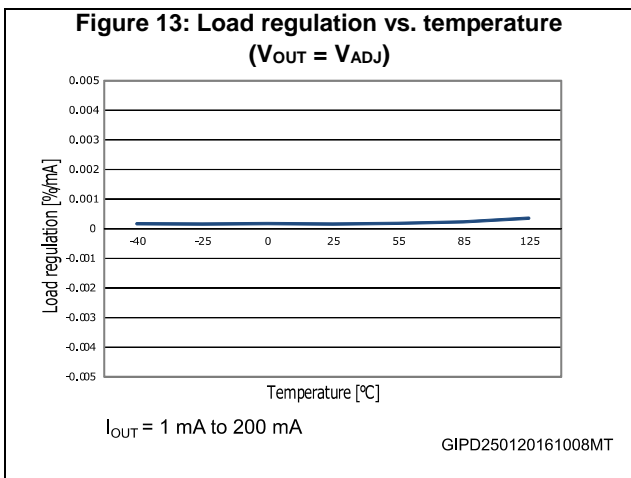
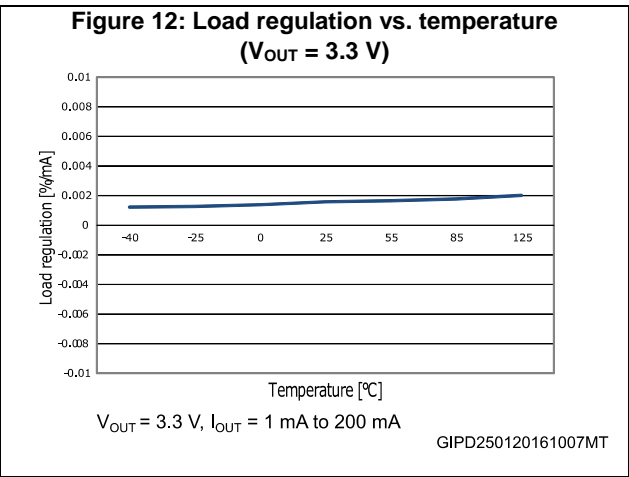
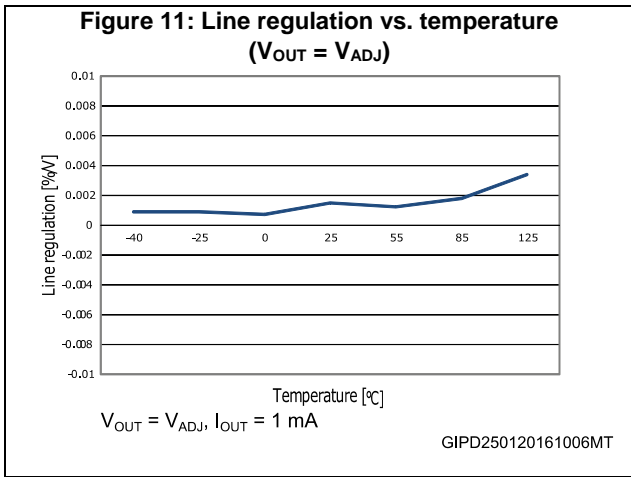

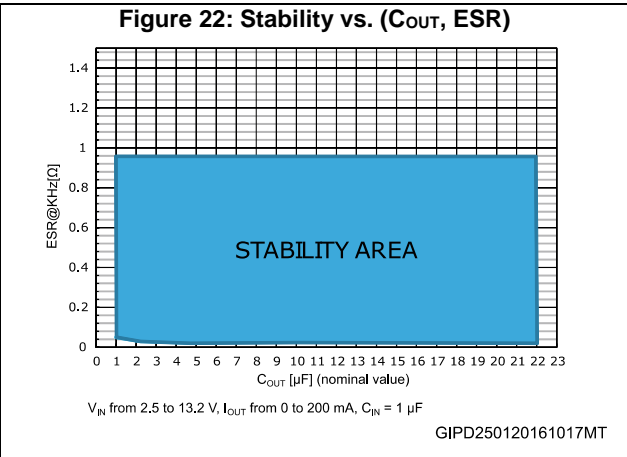
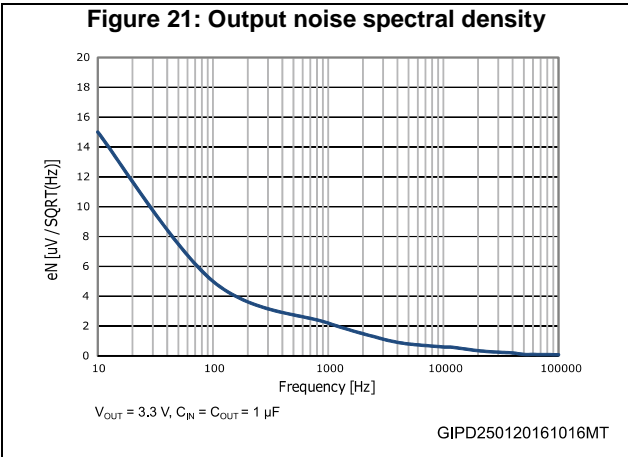
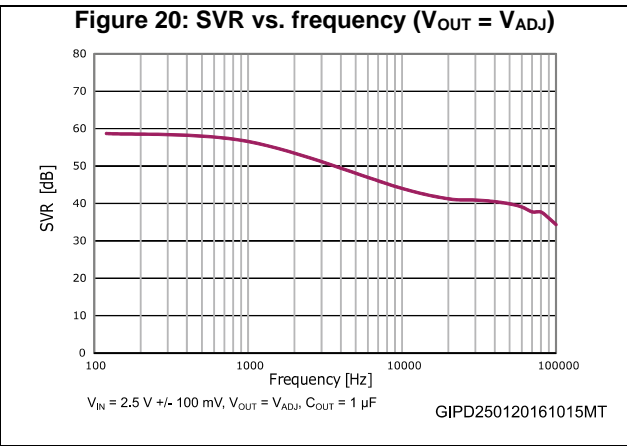
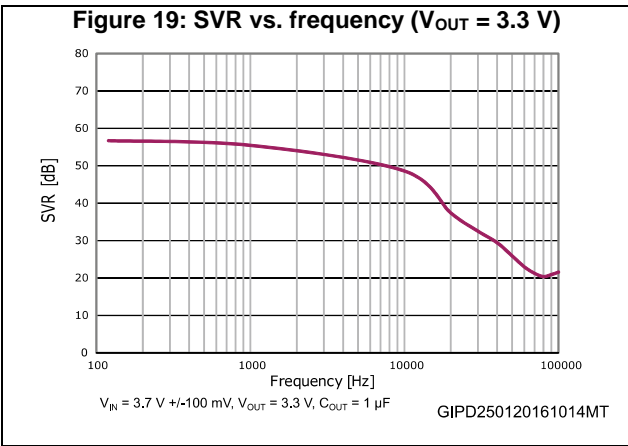
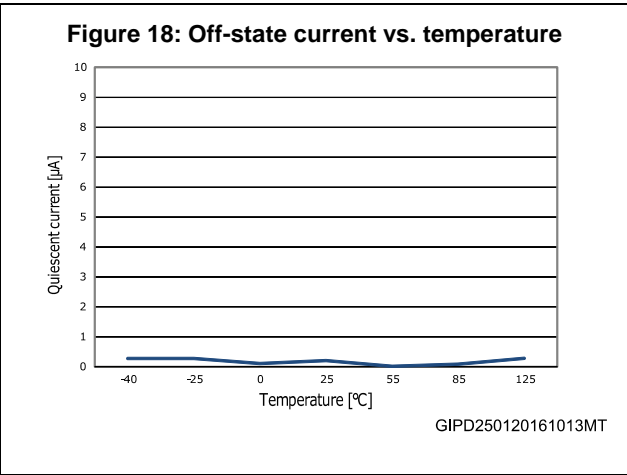
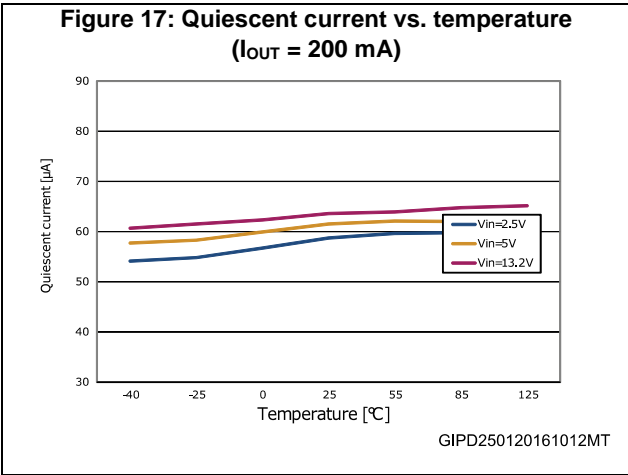
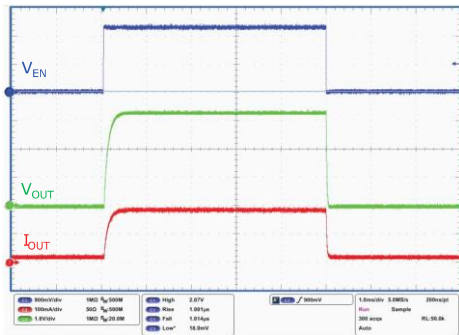
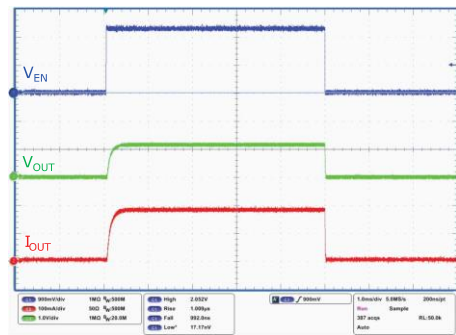

Figure 23: Startup with enable ($V_{OUT} = 3.3\text{ V}$)



$V_{IN} = 4.3\text{ V}$, $V_{EN} = 0\text{ V to } 2\text{ V}$, $I_{OUT} = 0.2\text{ A}$, $V_{OUT} = 3.3\text{ V}$, $T_r = T_f = 1\ \mu\text{s}$
GIPD250120161426MT

Figure 24: Startup with enable ($V_{OUT} = V_{ADJ}$)



$V_{IN} = 2.5\text{ V}$, $V_{EN} = 0\text{ V to } V_{IN}$, $I_{OUT} = 0.2\text{ A}$, $V_{OUT} = V_{ADJ}$, $T_r = T_f = 1\ \mu\text{s}$
GIPD250120161427MT

Figure 25: Turn-on time ($V_{OUT} = 3.3\text{ V}$)

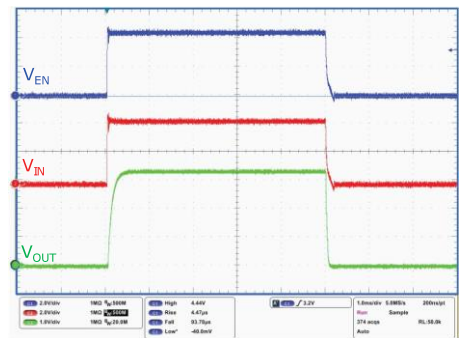

$V_{IN} = V_{EN} = 0\text{ V to } 4.3\text{ V}$, $I_{OUT} = 0.2\text{ A}$, $V_{OUT} = 3.3\text{ V}$, $T_r = 5\ \mu\text{s}$
GIPD250120161428MT

Figure 26: Turn-on time ($V_{OUT} = V_{ADJ}$)

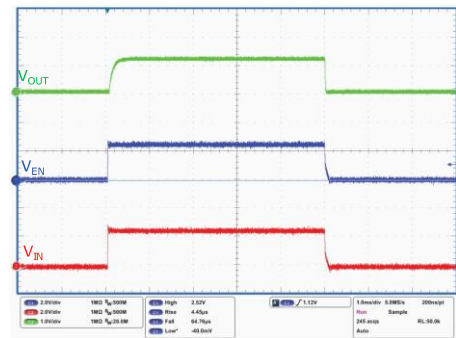

$V_{IN} = V_{EN} = 0\text{ V to } 2.5\text{ V}$, $I_{OUT} = 0.2\text{ A}$, $V_{OUT} = V_{ADJ}$, $T_r = 5\ \mu\text{s}$
GIPD250120161429MT

Figure 27: Line transient ($V_{OUT} = 3.3\text{ V}$)

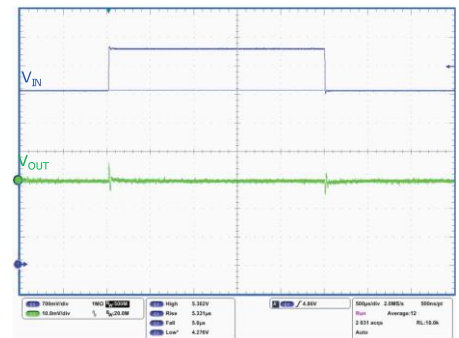

$V_{IN} = V_{EN} = 4.3\text{ V to } 5.3\text{ V}$, $I_{OUT} = 1\text{ mA}$, $V_{OUT} = 3.3\text{ V}$, $T_r = T_f = 5\ \mu\text{s}$
GIPD250120161430MT

Figure 28: Line transient ($V_{OUT} = V_{ADJ}$)

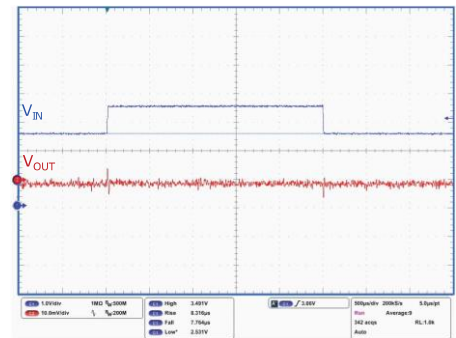

$V_{IN} = V_{EN} = 2.5\text{ V to } 3.5\text{ V}$, $I_{OUT} = 1\text{ mA}$, $V_{OUT} = V_{ADJ}$, $T_r = T_f = 5\ \mu\text{s}$
GIPD250120161431MT

Figure 29: Load transient ($V_{OUT} = 3.3\text{ V}$)

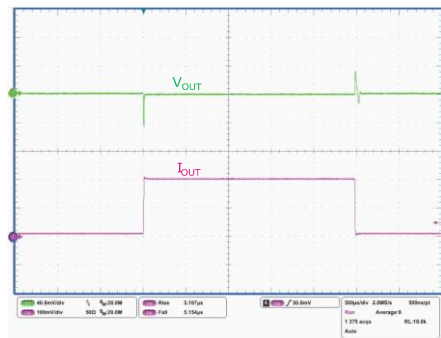

$V_{IN} = V_{EN} = 4.3\text{ V}$, $I_{OUT} = 1\text{ mA to } 0.2\text{ A}$, $V_{OUT} = 3.3\text{ V}$, $T_r = T_f = 5\text{ }\mu\text{s}$
GIPD250120161432MT

Figure 30: Load transient ($V_{OUT} = V_{ADJ}$)

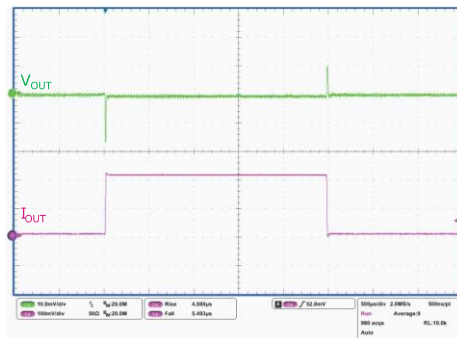

$V_{IN} = V_{EN} = 2.5\text{ V}$, $I_{OUT} = 1\text{ mA to } 0.2\text{ A}$, $V_{OUT} = V_{ADJ}$, $T_r = T_f = 5\text{ }\mu\text{s}$
GIPD250120161433MT

7 Package information

In order to meet environmental requirements, ST offers these devices in different grades of ECOPACK® packages, depending on their level of environmental compliance. ECOPACK® specifications, grade definitions and product status are available at: www.st.com. ECOPACK® is an ST trademark.

7.1 SOT23-5L package information

Figure 31: SOT23-5L package outline

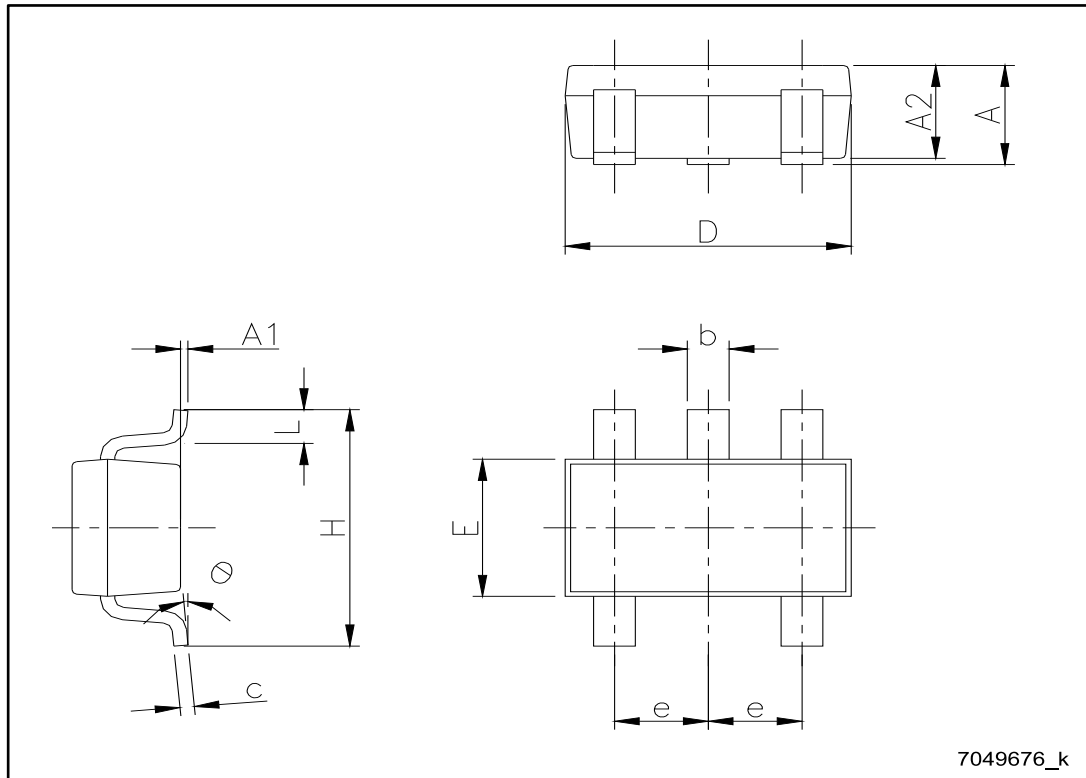
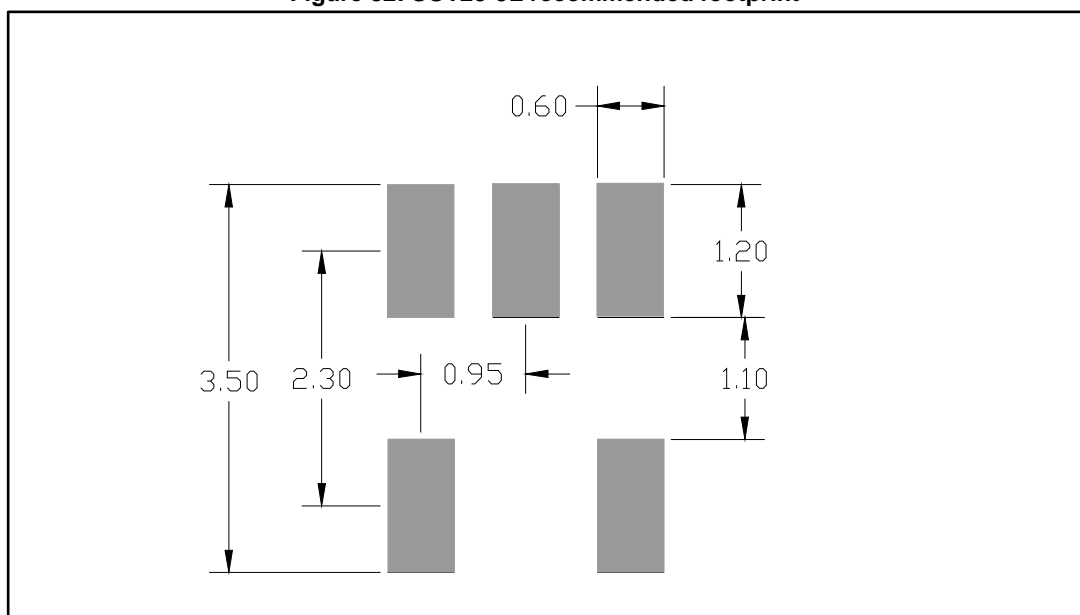

Table 8: SOT23-5L package mechanical data

Dim.	mm		
	Min.	Typ.	Max.
A	0.90		1.45
A1	0		0.15
A2	0.90		1.30
b	0.30		0.50
c	0.09		0.20
D		2.95	
E		1.60	
e		0.95	
H		2.80	
L	0.30		0.60
θ	0°		8°

Figure 32: SOT23-5L recommended footprint



Dimensions are in mm

7.2 SOT23-5L packing information

Figure 33: SOT23-5L tape and reel outline

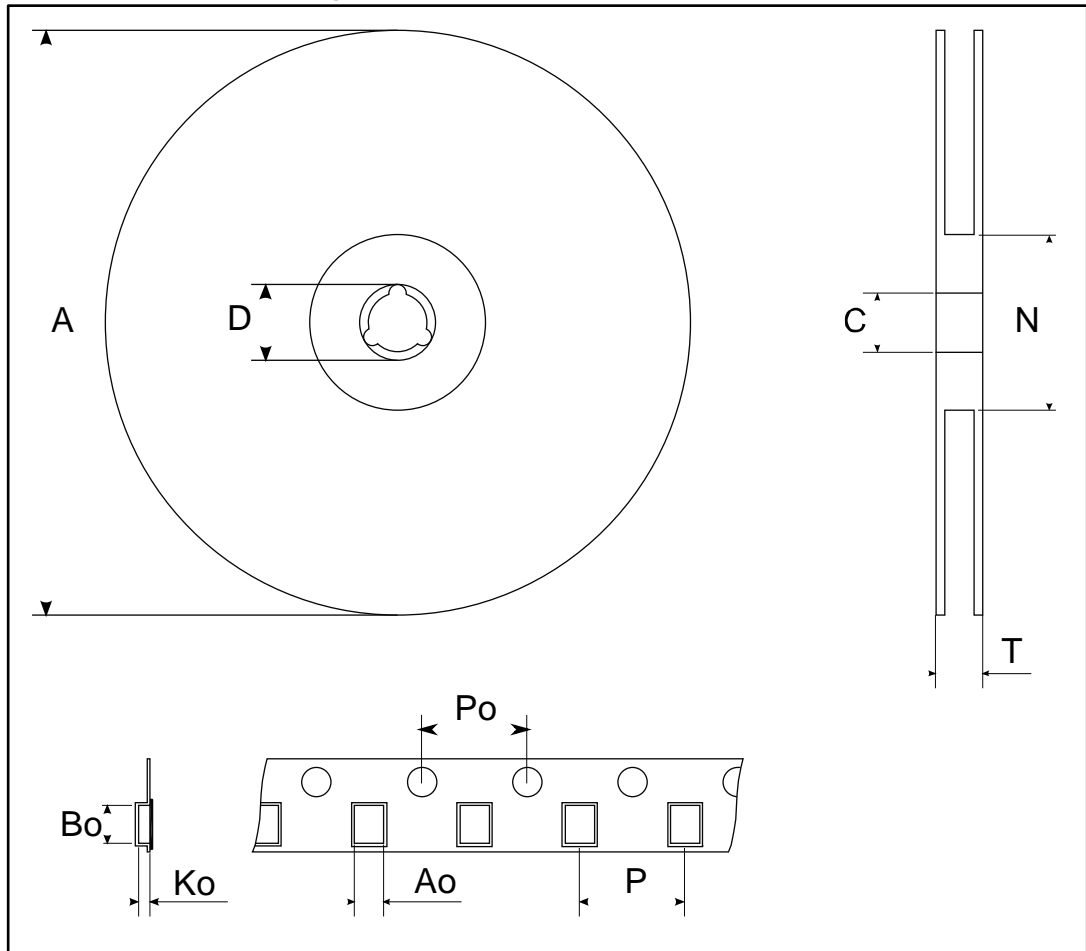

Table 9: SOT23-5L tape and reel mechanical data

Dim.	mm		
	Min.	Typ.	Max.
A			180
C	12.8	13.0	13.2
D	20.2		
N	60		
T			14.4
Ao	3.13	3.23	3.33
Bo	3.07	3.17	3.27
Ko	1.27	1.37	1.47
Po	3.9	4.0	4.1
P	3.9	4.0	4.1

7.3 SOT-89 package information

Figure 34: SOT-89 package outline

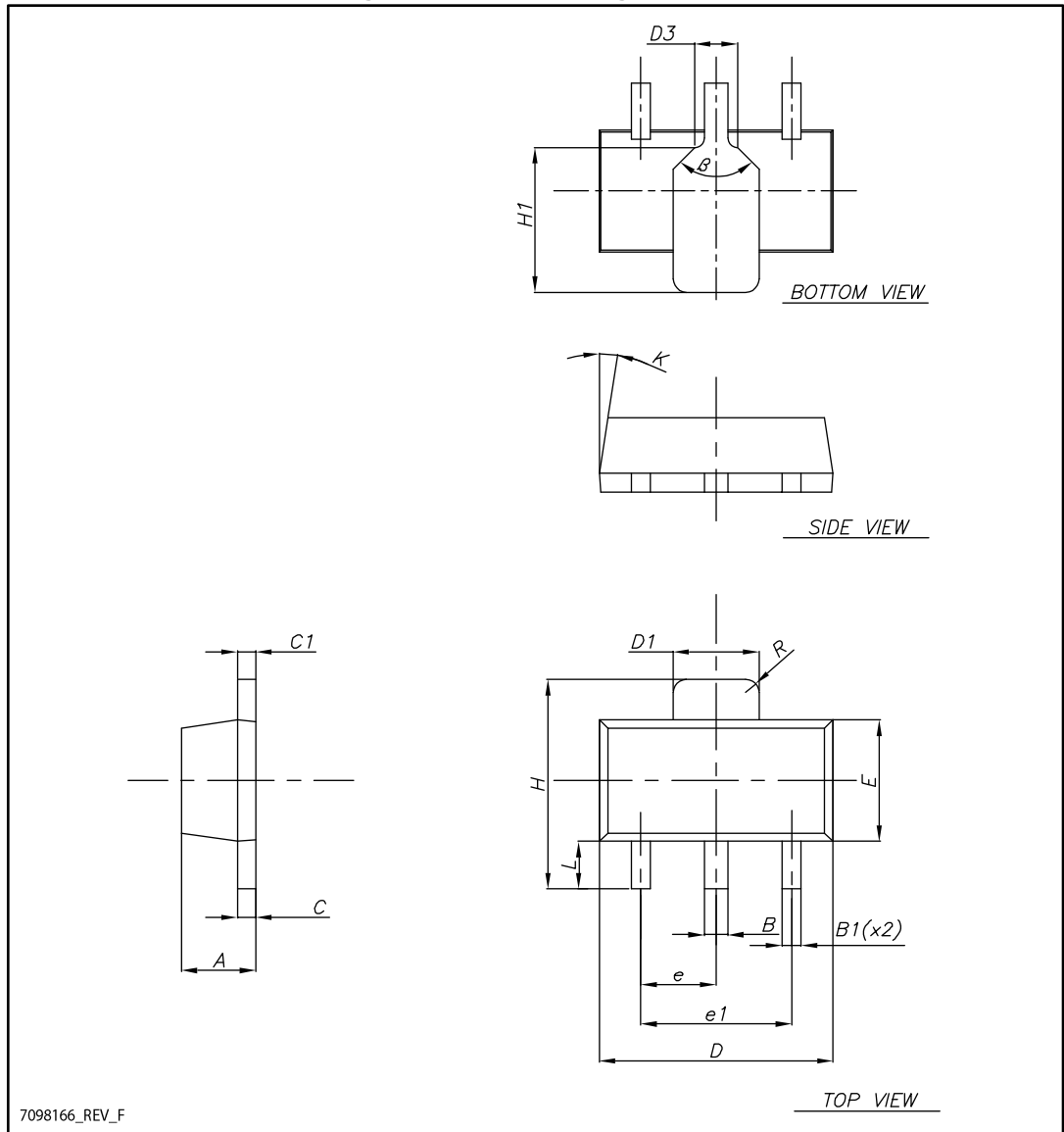
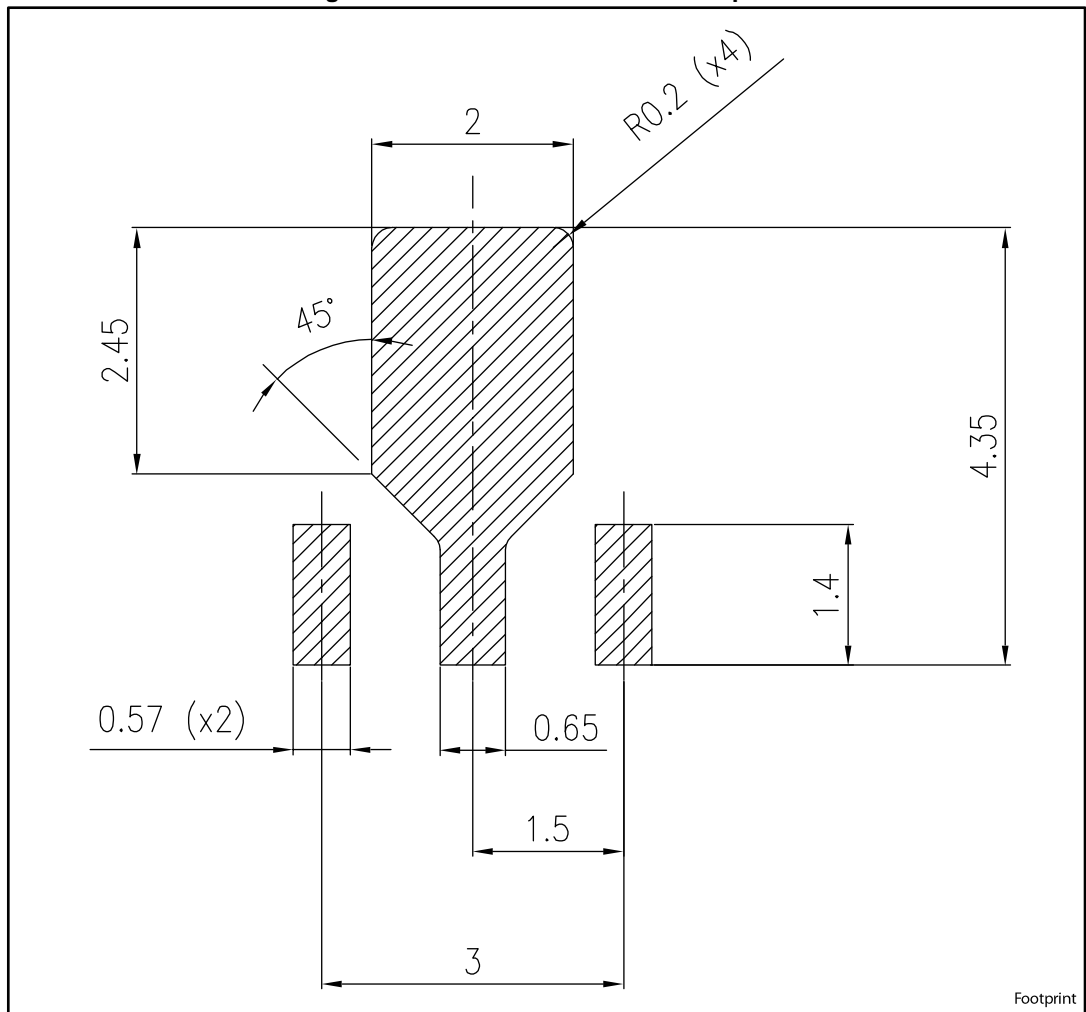

Table 10: SOT-89 mechanical data

Dim.	mm		
	Min.	Typ.	Max.
A	1.40		1.60
B	0.44		0.56
B1	0.36		0.48
C	0.35		0.44
C1	0.35		0.44
D	4.40		4.60
D1	1.62		1.83
D3		0.90	
E	2.29		2.60
e	1.42		1.57
e1	2.92		3.07
H	3.94		4.25
H1	2.70		3.10
K	1°		8°
L	0.89		120
R		0.25	
β		90°	

Figure 35: SOT-89 recommended footprint



7.4 SOT-89 packing information

Figure 36: SOT-89 carrier tape outline

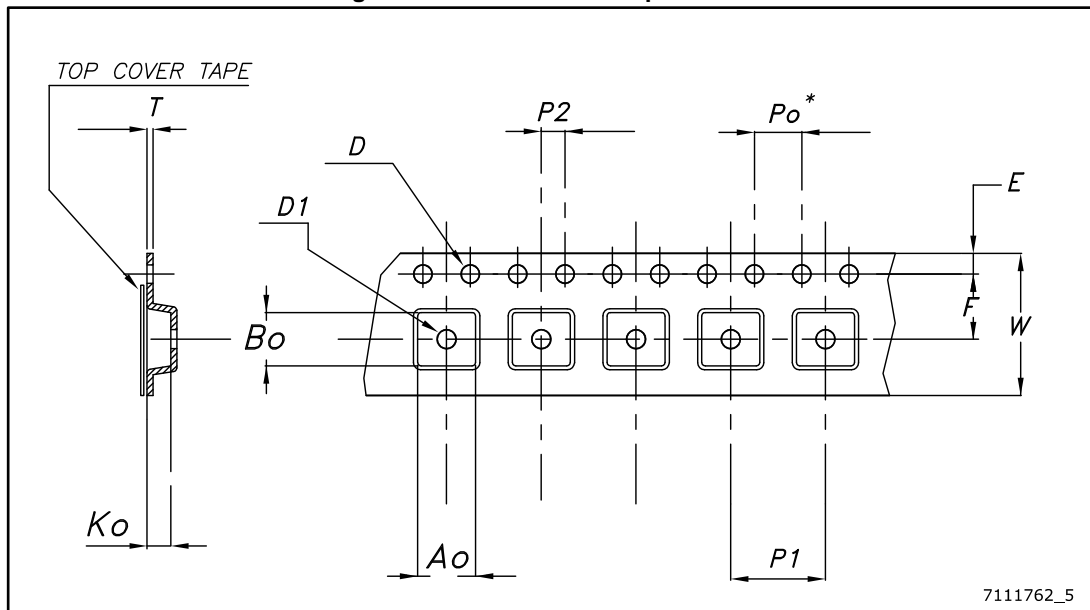

Table 11: SOT-89 carrier tape mechanical data

Dim.	mm	
	Value	Tolerance
Ao	4.91	± 0.10
Bo	4.52	± 0.10
Ko	1.90	± 0.10
F	5.50	± 0.10
E	1.75	± 0.10
W	12	± 0.30
P2	2	± 0.10
Po	4	± 0.10
P1	8	± 0.10
T	0.30	± 0.10
D	Ø 1.55	± 0.05
D1	Ø 1.60	± 0.10

7.5 SOT323-5L package information

Figure 37: SOT323-5L package outline

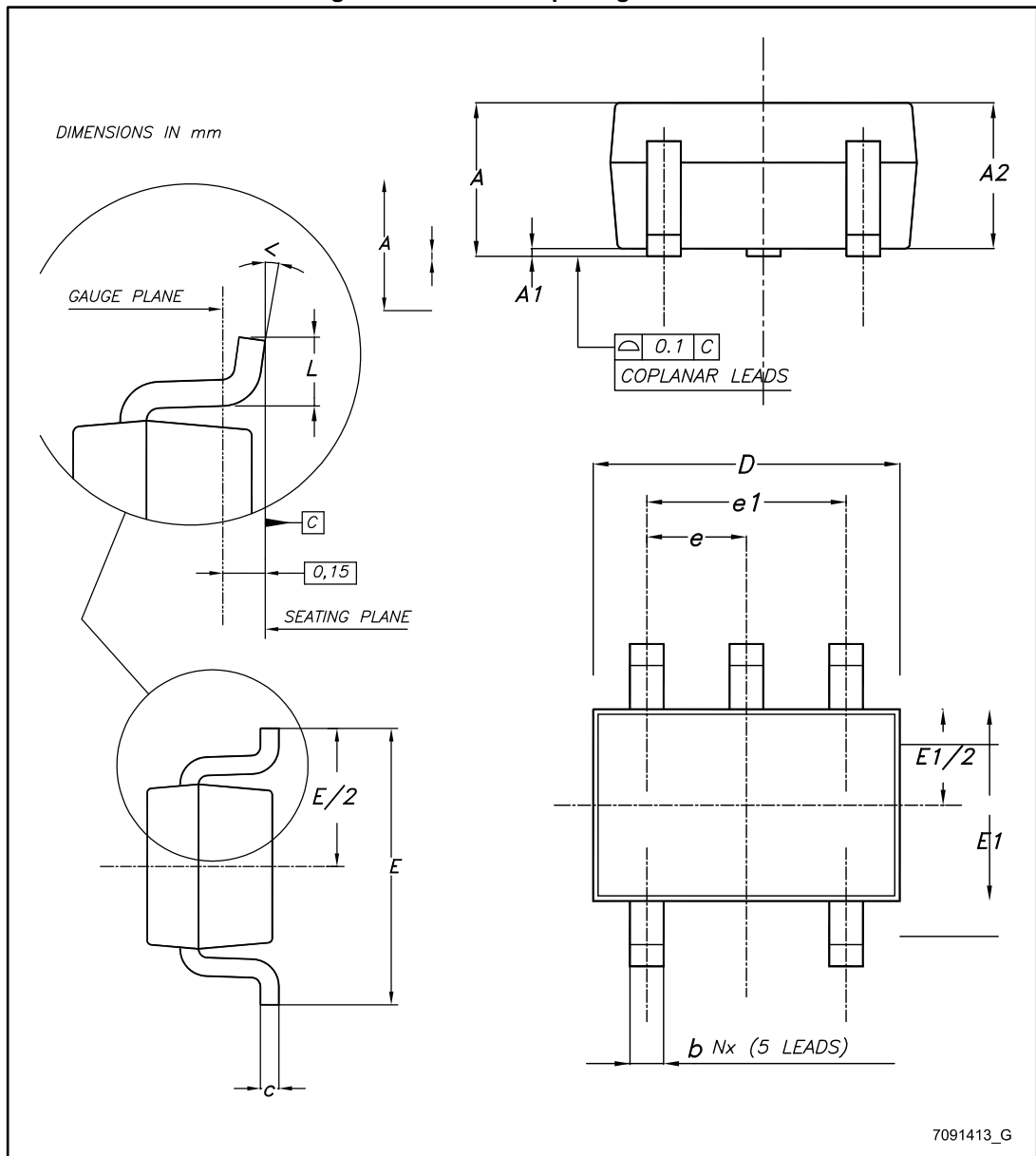
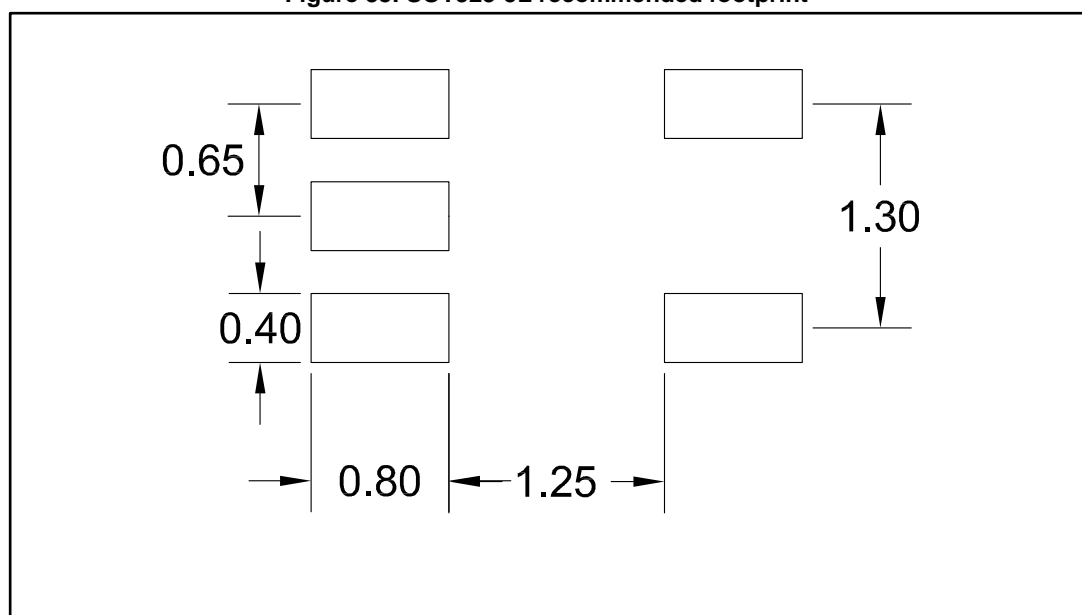

Table 12: SOT323-5L package mechanical data

Dim.	mm		
	Min.	Typ.	Max.
A	0.80		1.10
A1	0		0.10
A2	0.80	0.90	1
b	0.15		0.30
c	0.10		0.22
D	1.80	2	2.20
E	1.80	2.10	2.40
E1	1.15	1.25	1.35
e		0.65	
e1		1.30	
L	0.26	1.36	0.46
<	0°		8°

Figure 38: SOT323-5L recommended footprint



7.6 DFN6 1.2x1.3 package information

Figure 39: DFN6 package outline

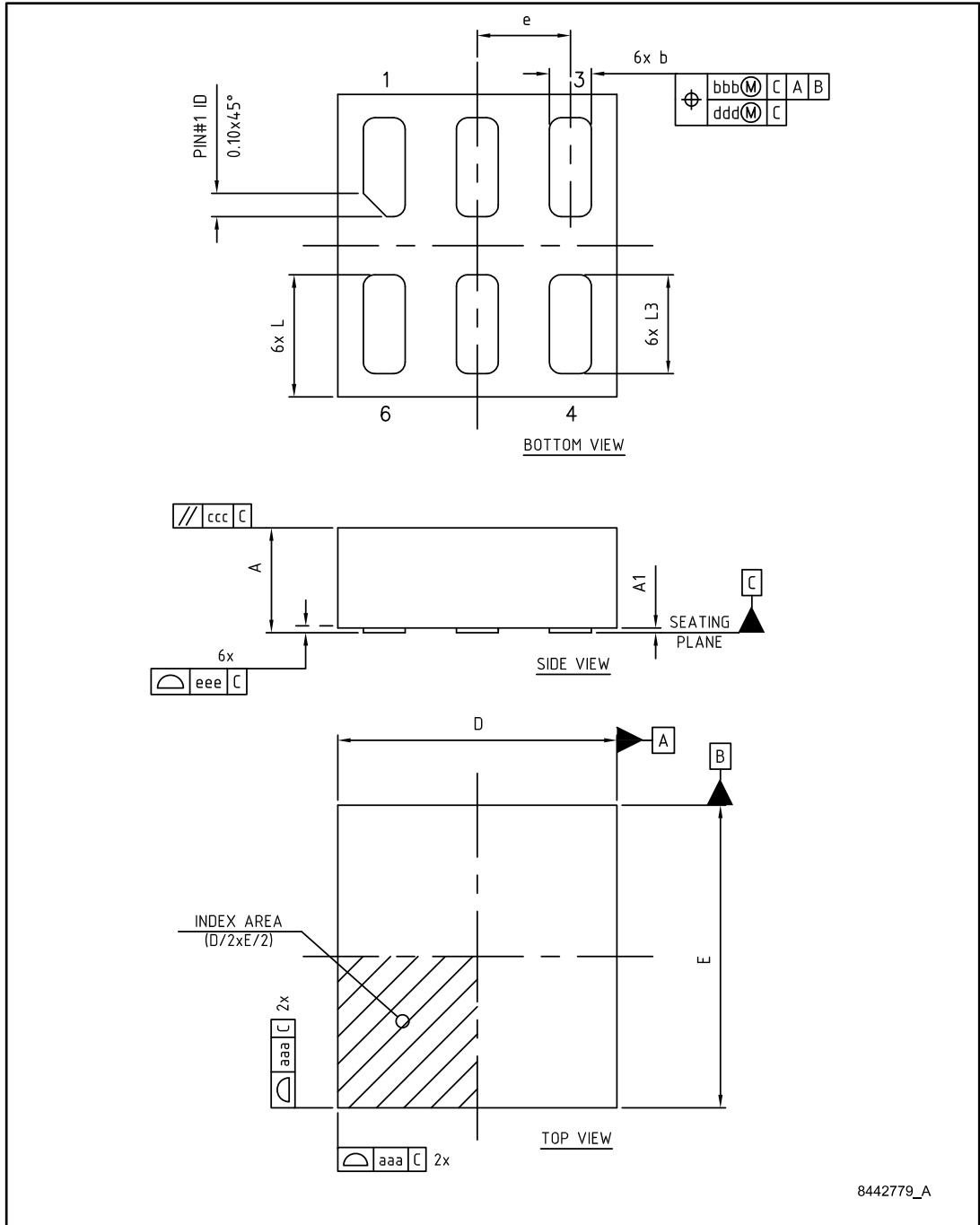
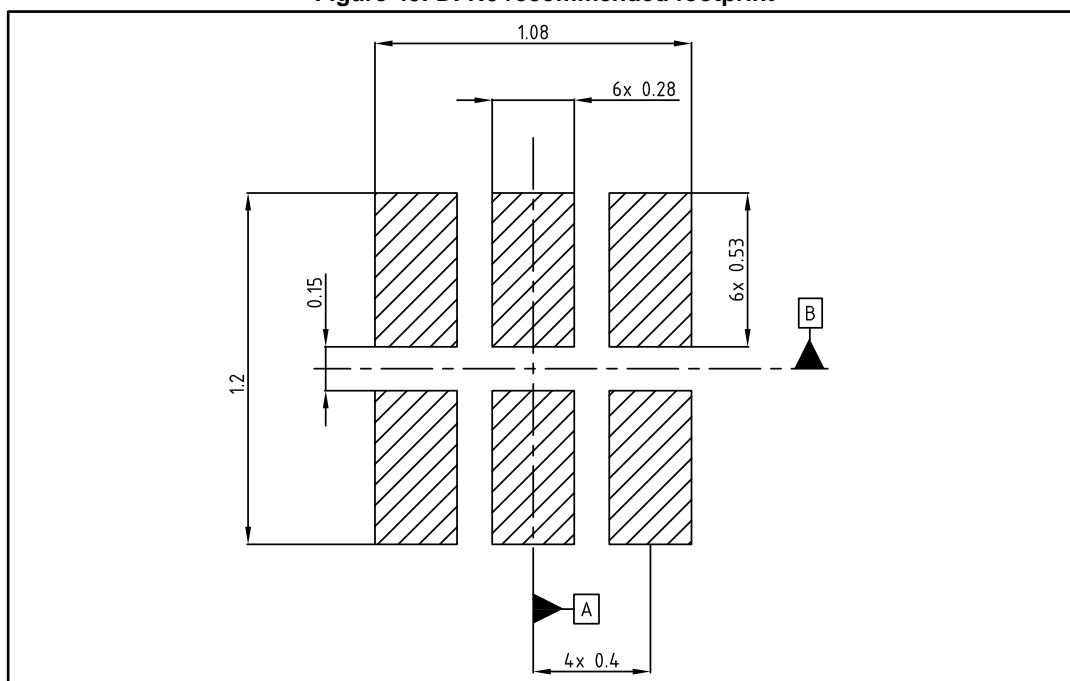

Table 13: DFN6 package mechanical data

Dim.	mm		
	Min.	Typ.	Max.
A	0.41	0.45	0.50
A1	0.00	0.02	0.05
D	-	1.20	-
E	-	1.30	-
e	-	0.40	-
b	0.15	0.18	0.25
L	0.475	0.525	0.575
L3	0.375	0.425	0.475
aaa	-	0.05	-
bbb	-	0.10	-
ccc	-	0.05	-
ddd	-	0.05	-
eee	-	0.05	-

Figure 40: DFN6 recommended footprint



8 Ordering information

Table 14: Order codes

SOT323-5L	SOT23-5L	SOT-89	DFN6	Output voltage (V)
LDK220C25R	LDK220M25R		LDK220PU25R	2.5
LDK220C27R	LDK220M27R		LDK220PU27R	2.7
LDK220C30R	LDK220M30R	LDK220U30R	LDK220PU30R	3
LDK220C32R	LDK220M32R		LDK220PU32R	3.2
LDK220C33R	LDK220M33R	LDK220U33R	LDK220PU33R	3.3
LDK220C36R	LDK220M36R	LDK220U36R	LDK220PU36R	3.6
LDK220C40R	LDK220M40R		LDK220PU40R	4
LDK220C50R	LDK220M50R	LDK220U50R	LDK220PU50R	5
LDK220C-R	LDK220M-R		LDK220PU-R	adj

9 Revision history

Table 15: Document revision history

Date	Revision	Changes
19-Mar-2014	1	Initial release.
24-Nov-2014	2	Updated the features in cover page, <i>Table 6: LDK220 electrical characteristics for fixed output version</i> , <i>Table 7: LDK220 electrical characteristics for adjustable version</i> , <i>Table 8: SOT23-5L mechanical data</i> , and <i>Section 6: Typical characteristics</i> . Minor text changes.
19-May-2015	3	Added SOT-89 package. Updated features in cover page. Updated <i>Section 2: Pin configuration</i> , <i>Section 3: Typical application</i> , <i>Table 5: Thermal data</i> , <i>Section 7: Package information</i> and <i>Section 8: Ordering information</i> . Minor text changes.
24-Oct-2016	4	Updated <i>Table 7: "LDK220 electrical characteristics for adjustable version"</i> and <i>Section 7: "Package information"</i> . Minor text changes.

IMPORTANT NOTICE – PLEASE READ CAREFULLY

STMicroelectronics NV and its subsidiaries ("ST") reserve the right to make changes, corrections, enhancements, modifications, and improvements to ST products and/or to this document at any time without notice. Purchasers should obtain the latest relevant information on ST products before placing orders. ST products are sold pursuant to ST's terms and conditions of sale in place at the time of order acknowledgement.

Purchasers are solely responsible for the choice, selection, and use of ST products and ST assumes no liability for application assistance or the design of Purchasers' products.

No license, express or implied, to any intellectual property right is granted by ST herein.

Resale of ST products with provisions different from the information set forth herein shall void any warranty granted by ST for such product.

ST and the ST logo are trademarks of ST. All other product or service names are the property of their respective owners.

Information in this document supersedes and replaces information previously supplied in any prior versions of this document.

© 2016 STMicroelectronics – All rights reserved

单击下面可查看定价，库存，交付和生命周期等信息

[>>STMicroelectronics\(意法半导体\)](#)