

High Power Thin Film Wraparound Chip Resistor

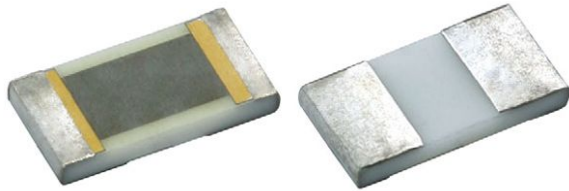

PHP series chip resistors are designed with enlarged backside terminations to reduce the thermal resistance between the topside resistor layer and the solder joint on the end users circuit board.

Actual power handling capability is limited by the end user mounting process. As with any high power chip resistor the ability to remove the generated heat is critical to the overall performance of the device.

FEATURES

- High purity ceramic substrate
- Power rating to 2.5 W
- Resistance range 10 Ω to 30.1 k Ω
- Resistor tolerance to $\pm 0.1\%$
- TCR to ± 25 ppm/ $^{\circ}\text{C}$
- Flame resistant UL 94 V-0

APPLICATIONS

- Power supplies
- Power switching
- Braking system
- Test and measurement equipment
- Motor deflection circuits

TYPICAL PERFORMANCE

	ABSOLUTE
TCR	25
TOL.	0.1

STANDARD ELECTRICAL SPECIFICATIONS		
TEST	SPECIFICATIONS	CONDITIONS
Material	Nichrome	-
Resistance Range	10 Ω to 30.1 k Ω	-
TCR: Absolute	25 ppm/ $^{\circ}\text{C}$, 50 ppm/ $^{\circ}\text{C}$ (standard) and, 100 ppm/ $^{\circ}\text{C}$	-55 $^{\circ}\text{C}$ to +125 $^{\circ}\text{C}$
Tolerance: Absolute	0.1 %, 0.5 %, 1.0 % and, 5.0 %	+25 $^{\circ}\text{C}$
Power Rating: Resistor	0.375 W - 2.5 W ⁽¹⁾	Maximum at +70 $^{\circ}\text{C}$
Stability: Absolute	ΔR 0.1 %	2000 h at +70 $^{\circ}\text{C}$
Stability: Ratio	Not applicable	-
Voltage Coefficient	< 0.1 ppm/V	-
Working Voltage	75 V to 200 V	-
Operating Temperature Range	-55 $^{\circ}\text{C}$ to +155 $^{\circ}\text{C}$	-
Storage Temperature Range	-55 $^{\circ}\text{C}$ to +155 $^{\circ}\text{C}$	-
Noise	< -30 dB	-
Shelf Life Stability: Absolute	$\pm 0.01\%$	1 year at +25 $^{\circ}\text{C}$

COMPONENT RATINGS			
CASE SIZE	POWER RATING (mW)	WORKING VOLTAGE (V)	RESISTANCE RANGE (Ω)
0603	375 ⁽¹⁾	75	10 to 30.1K
0805	625 ⁽¹⁾	100	10 to 30.1K
1206	1000 ⁽¹⁾	200	10 to 30.1K
2512	2500 ⁽¹⁾	200	10 to 30.1K

Note

⁽¹⁾ Dependent on component mounting by user.

ENVIRONMENTAL TESTS (Vishay Performance vs. MIL-PRF-55342 Requirements)		
ENVIRONMENTAL TEST	LIMITS MIL-PRF-55342 CHARACTERISTIC "E"	TYPICAL VISHAY PERFORMANCE
Resistance Temperature Characteristic	± 25 ppm/ $^{\circ}\text{C}$	± 15 ppm/ $^{\circ}\text{C}$
Maximum Ambient Temperature at Rated Wattage	+70 $^{\circ}\text{C}$	+70 $^{\circ}\text{C}$
Maximum Ambient Temperature at Power Derating	+150 $^{\circ}\text{C}$	+150 $^{\circ}\text{C}$
Thermal Shock	$\pm 0.1\%$	$\pm 0.04\%$
Low Temperature Operation	$\pm 0.1\%$	$\pm 0.001\%$
Short Time Overload	$\pm 0.1\%$	$\pm 0.003\%$
High Temperature Exposure	$\pm 0.1\%$	$\pm 0.030\%$
Resistance to Soldering Heat	$\pm 0.2\%$	$\pm 0.007\%$
Moisture Resistance	$\pm 0.2\%$	$\pm 0.002\%$
Life at +70 $^{\circ}\text{C}$ for 2000 h	$\pm 0.5\%$	$\pm 0.100\%$

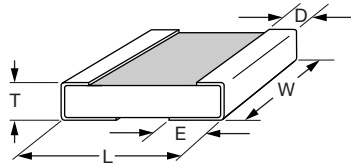
DIMENSIONS in inches

CASE SIZE	LENGTH	WIDTH W (± 0.005)	THICKNESS MIN./MAX.	TOP PAD D (± 0.005)	BOTTOM PAD E (± 0.005)
0603	0.064 \pm 0.006	0.032	0.020 max.	0.012	0.021
0805	0.080 \pm 0.006	0.050	0.015/0.033	0.016	0.025
1206	0.126 \pm 0.008	0.063	0.015/0.033	0.020 + 0.005/- 0.010	0.040
2512	0.259 + 0.009/- 0.015	0.124	0.015/0.033	0.02	0.050

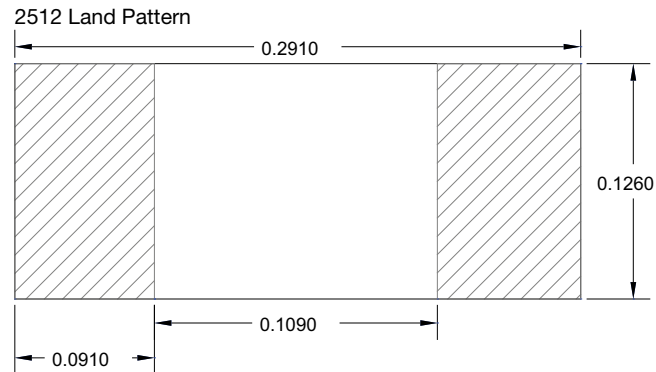
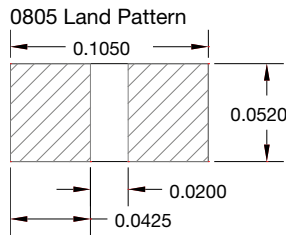
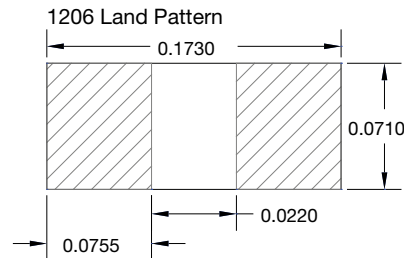
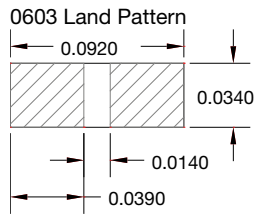
LAND PATTERN DIMENSIONS in inches

STANDARD MATERIAL SPECIFICATIONS

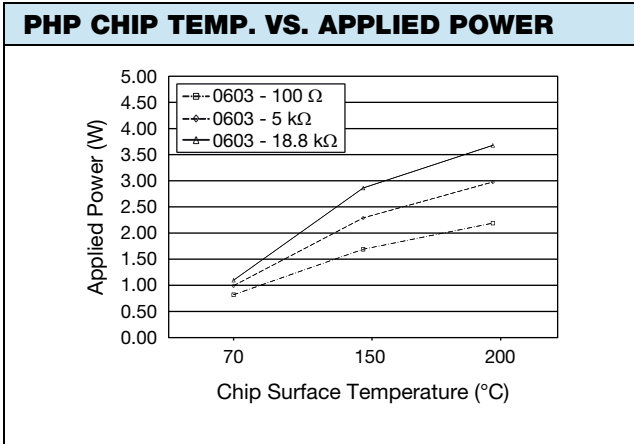
Resistive Element	Nichrome
Substrate Material	Alumina (Al ₂ O ₃)
Terminations (Tin/Lead)	Tin/lead solder over nickel barrier
Terminations (Lead (Pb)-free)	Tin/silver/copper (Sn96.5Ag3.0Cu0.5) solder over nickel barrier

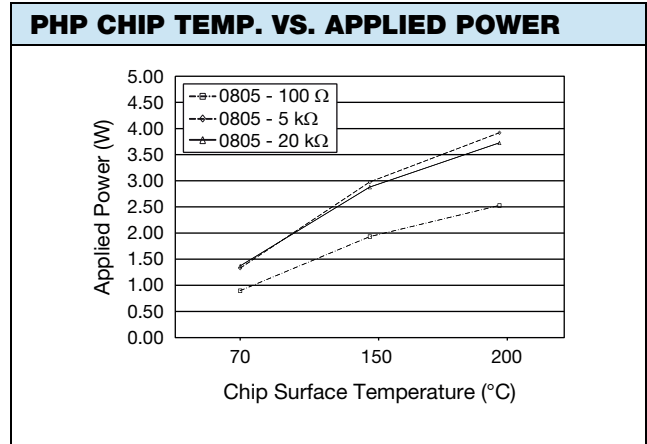

Note

- Chip surface temperature measured using FLIR SC645 thermal imaging system with an approximate test card surface temperature of 85 °C.



Note

- Chip surface temperature measured using FLIR SC645 thermal imaging system with an approximate test card surface temperature of 85 °C.

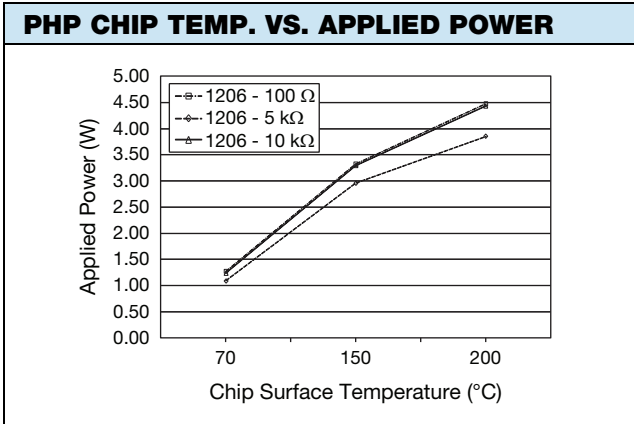

Notes

- Chip surface temperature measured using FLIR A40 thermal imaging system with an approximate test card surface temperature of 25 °C.
- Thermal imaging was conducted under ambient conditions resulting in a steady state test card surface temperature of 85 °C over the full range of power levels.
- Thermal imaging and load life testing was conducted mounting one device to 2" x 3" test cards with 2.5 mil copper plating on both surfaces. Thermal vias on 120 mil centers were utilized for heat transfer between surfaces of the test card.

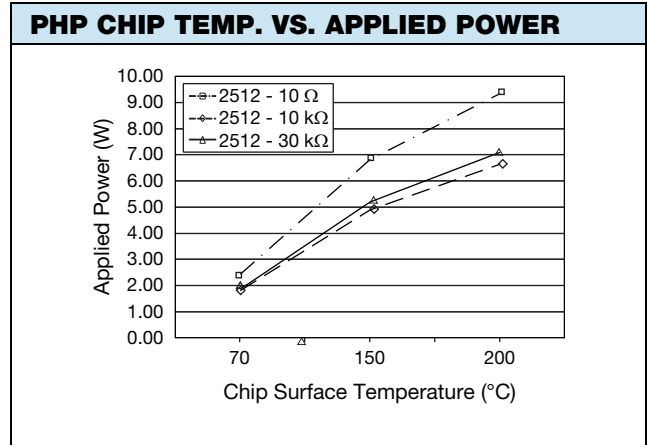

Notes

- Chip surface temperature measured using FLIR A40 thermal imaging system with an approximate test card surface temperature of 25 °C.

Case Size	2512	2512	2512
Resistance Value	Up to 10 Ω	Up to 10 kΩ	Up to 30 kΩ
Temperature	Power (W)		
70	2.44	1.81	1.87
150	6.82	4.89	5.19
200	9.33	6.63	7.09

SINGLE PULSE CURVES

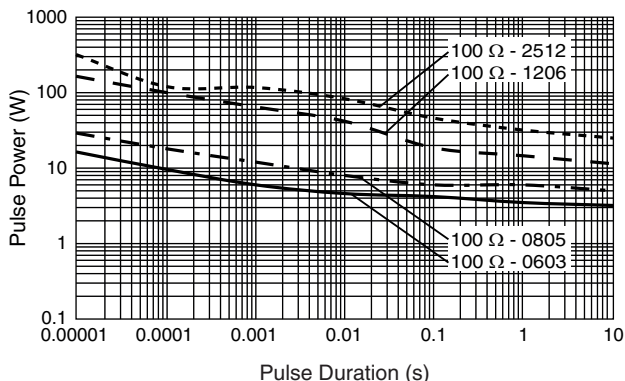

DERATING CURVE

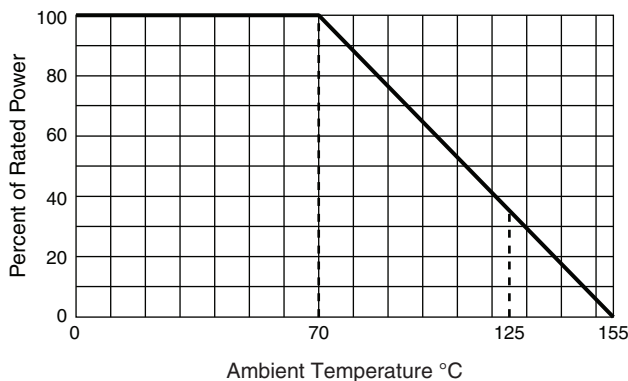

GLOBAL PART NUMBER INFORMATION

P	H	P	0	1	2	0	6	E	1	0	0	2	B	B	T	1
GLOBAL MODEL	SUBSTRATE	CASE SIZE	TCR		RESISTANCE			TOLERANCE		TERMINATION			PACKAGING			
PHP	0 = Alumina	0603 0805 1206 2512	E = ± 25 ppm/°C	H = ± 50 ppm/°C	K = ± 100 ppm/°C	The first 3 digits are significant figures and the last digit specifies the number of zeros to follow. "R" designates the decimal point. Example: 10R0 = 10 Ω 1000 = 100 Ω 1001 = 1 kΩ			B = ± 0.1 % D = ± 0.5 % F = ± 1.0 % G = ± 2.0 % J = ± 5.0 %	B = Wraparound Sn/Pb solder w/nickel barrier S = Wraparound lead (Pb)-free solder SAC-305 RoHS-compliant - e1			BS = BULK 100 min., 1 mult WS = WAFFLE 100 min., 1 mult WI = WAFFLE (item single lot day code) 100 min., 1 mult TAPE AND REEL T1 = 1000 min., 1000 mult T3 = 300 min., 300 mult T5 = 500 min., 500 mult TF = Full reel TS = 100 min., 1 mult TI = 100 min., 1 mult (item single lot date code) TP = 100 min., 1 mult (package unit single lot date)			



Disclaimer

ALL PRODUCT, PRODUCT SPECIFICATIONS AND DATA ARE SUBJECT TO CHANGE WITHOUT NOTICE TO IMPROVE RELIABILITY, FUNCTION OR DESIGN OR OTHERWISE.

Vishay Intertechnology, Inc., its affiliates, agents, and employees, and all persons acting on its or their behalf (collectively, "Vishay"), disclaim any and all liability for any errors, inaccuracies or incompleteness contained in any datasheet or in any other disclosure relating to any product.

Vishay makes no warranty, representation or guarantee regarding the suitability of the products for any particular purpose or the continuing production of any product. To the maximum extent permitted by applicable law, Vishay disclaims (i) any and all liability arising out of the application or use of any product, (ii) any and all liability, including without limitation special, consequential or incidental damages, and (iii) any and all implied warranties, including warranties of fitness for particular purpose, non-infringement and merchantability.

Statements regarding the suitability of products for certain types of applications are based on Vishay's knowledge of typical requirements that are often placed on Vishay products in generic applications. Such statements are not binding statements about the suitability of products for a particular application. It is the customer's responsibility to validate that a particular product with the properties described in the product specification is suitable for use in a particular application. Parameters provided in datasheets and / or specifications may vary in different applications and performance may vary over time. All operating parameters, including typical parameters, must be validated for each customer application by the customer's technical experts. Product specifications do not expand or otherwise modify Vishay's terms and conditions of purchase, including but not limited to the warranty expressed therein.

Except as expressly indicated in writing, Vishay products are not designed for use in medical, life-saving, or life-sustaining applications or for any other application in which the failure of the Vishay product could result in personal injury or death. Customers using or selling Vishay products not expressly indicated for use in such applications do so at their own risk. Please contact authorized Vishay personnel to obtain written terms and conditions regarding products designed for such applications.

No license, express or implied, by estoppel or otherwise, to any intellectual property rights is granted by this document or by any conduct of Vishay. Product names and markings noted herein may be trademarks of their respective owners.

单击下面可查看定价，库存，交付和生命周期等信息

[>>Vishay\(威世\)](#)