

Dual LDO Regulator with ON/OFF Switch

■ GENERAL DESCRIPTION

The XC6415 series is a highly accurate, CMOS Dual LDO voltage regulator. Performance features include low output noise, high ripple rejection rate, and low dropout. Extremely dense power supply circuit can be organized with a 2 channelled high speed voltage regulator in low ON resistance which is built-in to an ultra small USP-6C package. The output voltage for each regulator is set independently by laser trimming and selectable in 0.05V increments within a range of 0.8 to 5.0V. The EN function allows the output of each regulator to be turned off independently. In this state, the electric charge at the output capacitor (C_L) will be discharged via the internal auto-discharge switch, and as a result the V_{OUT} pin quickly returns to the V_{SS} level. The output stabilization capacitor (C_L) is also compatible with low ESR ceramic capacitors. The high level of output stability is maintained even during frequent load fluctuations, due to the excellent transient response performance. Because regulator 1 and 2 are completely isolated, a cross talk between each channel, which causes a problem during load fluctuations, can be greatly reduced.

■ APPLICATIONS

- Smart phones / Mobile phones
- Portable game consoles
- Digital still cameras / camcorders
- Digital audio equipment
- Mobile devices / terminals

■ FEATURES

Output Current	: 200mA (300mA limit, TYP.)
Dropout Voltage	: 95mV @ $I_{OUT}=100mA$ $V_{OUT}=3.0V$
Operating Voltage Range	: 1.5V~6.0V
Output Voltage Range	: 0.8V~5.0V (0.05V increments)
High Accuracy	: $\pm 1\%$ @ $V_{OUT}>2.0V$ $\pm 2\%$ @ $V_{OUT}\geq 1.5V$ $\pm 20mV$ @ $V_{OUT}\leq 2.0V$ $\pm 30mV$ @ $V_{OUT}< 1.5V$
Low Power Consumption	: 28 μA /ch (TYP.)
Stand-by Current	: Less than 0.1 μA
Ripple Rejection	: 65dB@1kHz
Operating Ambient Temperature	: -40°C ~ 85°C
Low ESR Capacitor	: 1.0 μF ceramic capacitors
Packages	: USP-6C, SOT-26, USPN-6
Environmentally Friendly	: EU RoHS Compliant, Pb Free

■ TYPICAL APPLICATION CIRCUITS

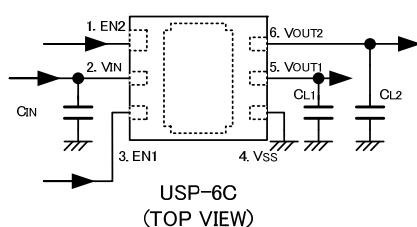
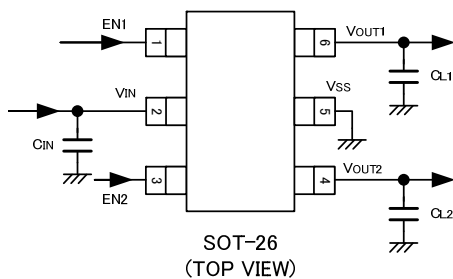

■ TYPICAL PERFORMANCE CHARACTERISTICS

● Cross Talk

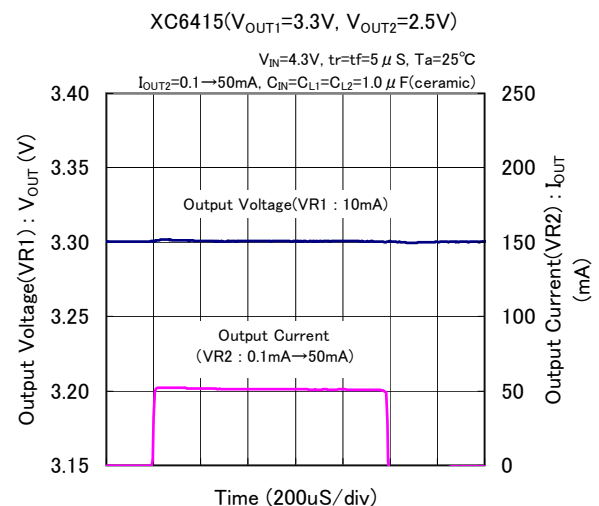

PIN CONFIGURATION

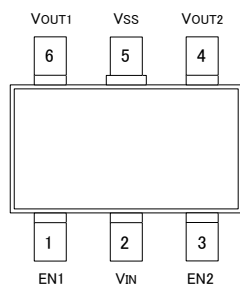

SOT-26
(TOP VIEW)

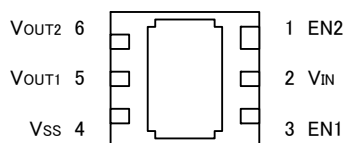

USP-6C*
(BOTTOM VIEW)

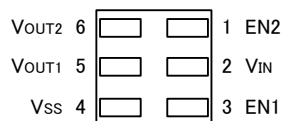

USPN-6
(BOTTOM VIEW)

*The dissipation pad for the USP-6C package should be solder-plated in recommended mount pattern and metal masking so as to enhance mounting strength and heat release. If the pad needs to be connected to other pins, it should be connected to the V_{SS} (No. 4) pin.

PIN ASSIGNMENT

PIN NUMBER			PIN NAME	FUNCTIONS
SOT-26	USP-6C	USPN-6		
1	3	3	EN1	ON/OFF Control 1
2	2	2	V _{IN}	Power Input
3	1	1	EN2	ON/OFF Control 2
4	6	6	V _{OUT2}	Output 2
5	4	4	V _{SS}	Ground
6	5	5	V _{OUT1}	Output 1

■ PRODUCT CLASSIFICATION

● Ordering Information

XC6415①②③④⑤⑥-⑦

DESIGNATOR	DESCRIPTION	SYMBOL	DESCRIPTON
①	Type of Regulator 1 (All EN High Active)	A	(without EN1 pulled down resistor) (Accuracy 1%) (without C _L discharge)
		B	(without EN1 pulled down resistor) (Accuracy 1%) (with C _L discharge)
		C	(without EN1 pulled down resistor) (Accuracy 2%) (without C _L discharge)
		D	(without EN1 pulled down resistor) (Accuracy 2%) (with C _L discharge)
		E	(with EN1 pulled down resistor) (Accuracy 1%) (without C _L discharge)
		F	(with EN1 pulled down resistor) (Accuracy 1%) (with C _L discharge)
		G	(with EN1 pulled down resistor) (Accuracy 2%) (without C _L discharge)
		H	(with EN1 pulled down resistor) (Accuracy 2%) (with C _L discharge)
②	Type of Regulator 2 (All EN High Active)	A	(without EN2 pulled down resistor) (Accuracy 1%) (without C _L discharge)
		B	(without EN2 pulled down resistor) (Accuracy 1%) (with C _L discharge)
		C	(without EN2 pulled down resistor) (Accuracy 2%) (without C _L discharge)
		D	(without EN2 pulled down resistor) (Accuracy 2%) (with C _L discharge)
		E	(with EN2 pulled down resistor) (Accuracy 1%) (without C _L discharge)
		F	(with EN2 pulled down resistor) (Accuracy 1%) (with C _L discharge)
		G	(with EN2 pulled down resistor) (Accuracy 2%) (without C _L discharge)
		H	(with EN2 pulled down resistor) (Accuracy 2%) (with C _L discharge)
③④	Output Voltage	-	Refer to the table in the next page.
⑤⑥-⑦ ^(*)	Packages (Order Unit)	MR-G	SOT-26 (3,000/Reel)
		MR	SOT-26 (3,000/Reel)
		ER-G	USP-6C (3,000/Reel)
		ER	USP-6C (3,000/Reel)
		7R-G	USPN-6 (5,000/Reel)

^(*) The "-G" suffix indicates that the products are Halogen and Antimony free as well as being fully EU RoHS compliant.

■ PRODUCT CLASSIFICATION (Continued)

DESIGNATOR ③④

③④	VR1	VR2	③④	VR1	VR2	③④	VR1	VR2	③④	VR1	VR2
01	1.80	2.80	41	2.80	3.00	81	2.00	3.30	C1	3.30	2.50
02	1.20	2.90	42	2.90	1.80	82	3.30	2.00	C2	1.85	2.85
03	1.80	1.80	43	3.00	1.80	83	2.80	1.20	C3	1.50	2.90
04	1.50	2.70	44	2.50	1.80	84	1.00	3.30	C4	1.80	3.20
05	2.85	2.85	45	1.80	2.85	85	2.70	2.70	C5	1.00	2.50
06	1.80	3.30	46	1.50	1.20	86	2.70	3.30	C6	3.10	2.80
07	3.00	3.00	47	2.85	1.50	87	2.90	2.90	C7	3.00	3.60
08	2.80	1.80	48	3.20	3.20	88	2.50	2.80	C8	1.30	3.00
09	1.20	1.20	49	1.20	3.00	89	2.50	3.00	C9	1.50	2.40
10	1.10	1.30	50	2.60	2.85	90	4.50	4.50	D0	3.30	3.60
11	1.30	1.50	51	4.20	3.10	91	3.30	5.00	D1	1.00	2.85
12	2.80	2.80	52	5.00	3.60	92	3.00	5.00	D2	1.80	1.85
13	2.50	3.30	53	1.80	1.20	93	1.80	2.90	D3	3.60	1.50
14	3.00	3.30	54	2.60	3.00	94	1.10	1.80	D4	3.00	2.80
15	1.20	1.80	55	2.60	2.60	95	1.20	1.30	D5	4.50	2.60
16	2.80	3.30	56	1.80	2.60	96	1.00	1.20	D6	2.00	1.80
17	3.30	3.30	57	2.60	3.30	97	1.50	2.50	D7	3.30	3.10
18	3.10	3.10	58	2.50	2.90	98	1.20	0.90	D8	3.20	3.10
19	2.80	1.50	59	1.80	2.70	99	3.15	3.15	D9	3.40	3.10
20	1.30	2.80	60	1.00	2.80	A0	3.10	1.80	E0	3.10	2.50
21	1.50	2.80	61	3.00	1.50	A1	1.80	2.00	E1	2.50	3.10
22	1.80	3.00	62	2.70	1.80	A2	1.50	1.30	E2	3.40	3.40
23	1.85	2.80	63	2.80	2.70	A3	2.85	2.60			
24	1.85	3.30	64	2.80	3.10	A4	1.25	2.50			
25	2.60	2.80	65	2.85	3.30	A5	1.85	1.20			
26	1.50	1.50	66	1.20	3.30	A6	3.30	1.20			
27	2.00	3.00	67	2.80	2.50	A7	1.80	1.95			
28	3.30	1.80	68	2.85	1.20	A8	2.85	3.00			
29	3.30	1.75	69	2.75	2.75	A9	1.55	2.80			
30	2.10	4.10	70	3.00	2.90	B0	1.90	1.90			
31	1.20	2.80	71	3.00	2.95	B1	2.50	2.85			
32	1.50	1.80	72	3.00	3.05	B2	3.00	1.00			
33	1.50	3.00	73	3.10	2.90	B3	1.30	1.80			
34	1.50	3.30	74	3.10	2.95	B4	2.70	3.00			
35	1.50	2.60	75	3.10	3.00	B5	2.80	1.90			
36	2.00	2.50	76	3.10	3.05	B6	2.50	0.90			
37	3.30	4.50	77	3.00	3.10	B7	3.15	2.85			
38	2.50	2.50	78	1.20	2.60	B8	2.60	1.30			
39	1.80	2.50	79	3.50	3.50	B9	3.00	2.50			
40	1.20	2.50	80	1.10	1.50	C0	3.30	1.10			

*For other output voltage combinations, please contact your local Torex sales office or representative.

■ BLOCK DIAGRAMS

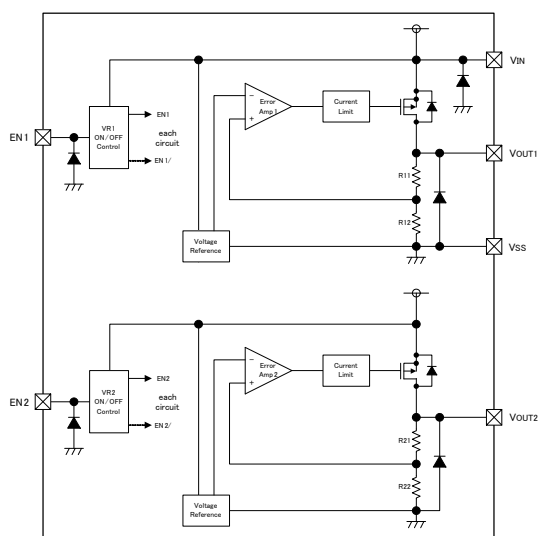

<XC6415AA, CC Series>

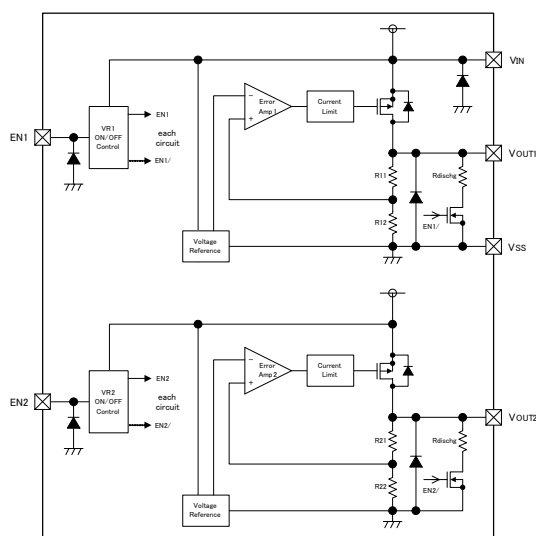

<XC6415BB, DD Series>

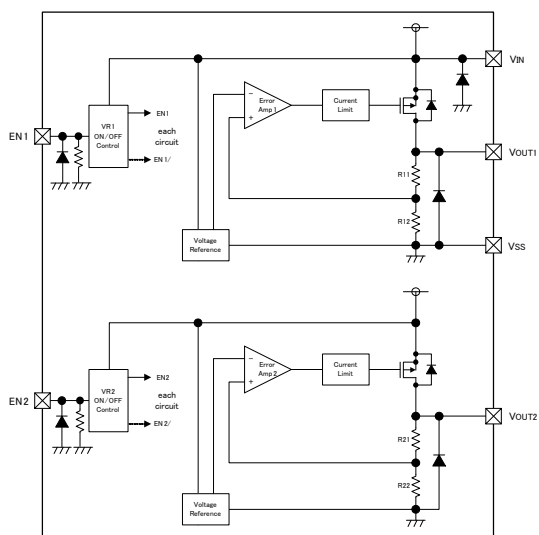

<XC6415EE, GG Series>

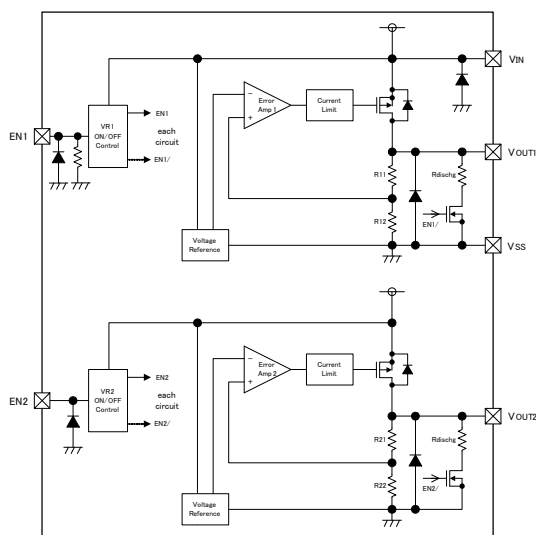

<XC6415FB, HD Series>

* Diodes inside the circuits are ESD protection diodes and parasitic diodes.

■ ABSOLUTE MAXIMUM RATINGS

Ta=25°C

PARAMETER	SYMBOL	RATINGS	UNITS
Input Voltage	V _{IN}	- 0.3 ~ + 6.5	V
Output Current	I _{OUT1} + I _{OUT2}	500 ^(*1)	mA
Output Voltage 1 / Output Voltage 2	V _{OUT1} / V _{OUT2}	V _{SS} - 0.3 ~ V _{IN} + 0.3	V
EN1/EN2 Input Voltage	V _{EN1} / V _{EN2}	V _{SS} - 0.3 ~ + 6.5	V
Power Dissipation	Pd	250	mW
		100	
		1000 (PCB mounted) ^(*2)	
		100	
Operating Ambient Temperature	T _{opr}	- 40 ~ + 85	°C
Storage Temperature	T _{stg}	- 55 ~ + 125	°C

*1: Please use within the range of Pd > { (V_{IN}-V_{OUT1})×I_{OUT1} + (V_{IN}-V_{OUT2})×I_{OUT2} }

*2: The power dissipation shown is PCB mounted. Please refer to page 21 for details.

ELECTRICAL CHARACTERISTICS

● XC6415 Series

Regulator 1, Regulator 2

Ta=25°C

PARAMETER	SYMBOL	CONDITIONS	MIN.	TYP.	MAX.	UNITS	CIRCUITS
Output Voltage	$V_{OUT(E)}$ ⁽²⁾	$V_{OUT(T)} \geq 2.0V$, $V_{EN}=V_{IN}$, $I_{OUT}=10mA$	$\times 0.99$ ⁽³⁾	$V_{OUT(T)}$ ⁽⁴⁾	$\times 1.01$ ⁽³⁾	V	①
		$V_{OUT} \leq 1.95V$, $V_{EN}=V_{IN}$, $I_{OUT}=10mA$	-0.02 ⁽³⁾		+0.02 ⁽³⁾		
		$V_{OUT(T)} \geq 1.5V$ $V_{EN}=V_{IN}$, $I_{OUT}=10mA$	$\times 0.98$ ⁽³⁾		$\times 1.02$ ⁽³⁾		
		$V_{OUT} \leq 1.45V$ $V_{EN}=V_{IN}$, $I_{OUT}=10mA$	-0.03 ⁽³⁾		+0.03 ⁽³⁾		
Output Current	I_{OUTMAX}		200	-	-	mA	①
Load Regulation	ΔV_{OUT}	$V_{EN}=V_{IN}$, $0.1mA \leq I_{OUT} \leq 100mA$	E-1			mV	①
Dropout Voltage ⁽⁵⁾	Vdif	$I_{OUT}=100mA$, $V_{EN}=V_{IN}$	E-2			mV	①
Supply Current	I_{SS}	$V_{IN}=V_{EN}=V_{OUT(T)}+1.0V$, $I_{OUT}=0mA$	-	28	60	μA	②
Stand-by Current	I_{STBY}	$V_{IN}=6.0V$, $V_{EN}=V_{SS}$	-	0.01	0.10	μA	②
Line Regulation	$\Delta V_{OUT}/$ $(\Delta V_{IN} \cdot V_{OUT})$	$V_{OUT(T)}+0.5V \leq V_{IN} \leq 6.0V$: $V_{OUT(T)} \geq 1.0V$, $V_{EN}=V_{IN}$, $I_{OUT}=10mA$	-	0.01	0.20	%V	①
		$1.5V \leq V_{IN} \leq 6.0V$: $V_{OUT(T)} \leq 0.95V$ $V_{EN}=V_{IN}$, $I_{OUT}=10mA$					
Input Voltage	V_{IN}		1.5	-	6.0	V	①
Output Voltage Temperature Characteristics	$\Delta V_{OUT}/$ $(\Delta Ta \cdot V_{OUT})$	$V_{EN}=V_{IN}$, $I_{OUT}=30mA$ $-40^\circ C \leq Ta \leq 85^\circ C$	-	± 100	-	ppm/°C	①
Ripple Rejection Rate	PSRR	$V_{IN}=\{V_{OUT(T)}+1.0\}V_{DC}+0.5Vp-pAC$: $V_{OUT(T)} \leq 4.75V$, $V_{EN}=V_{IN}$, $I_{OUT}=30mA$, $f=1kHz$	-	65	-	dB	③
		$V_{IN}=5.75V_{DC}+0.5Vp-pAC$: $V_{OUT(T)} \geq 4.8V$, $V_{EN}=V_{IN}$, $I_{OUT}=30mA$, $f=1kHz$					
Limit Current	I_{LIM}	$V_{EN}=V_{IN}$	210	300	-	mA	①
Short Current	I_{SHORT}	$V_{EN}=V_{IN}$, Short V_{OUT} to V_{SS} level	-	20	-	mA	①
EN "H" Level Voltage	V_{ENH}		1.2	-	6.0	V	①
EN "L" Level Voltage	V_{ENL}		-	-	0.3	V	①
EN "H" Level Current	I_{ENH}	$V_{EN}=V_{IN}$ (A~D Series)	-0.1	-	0.1	μA	①
		$V_{EN}=V_{IN}=6V$ (E~H Series)	-	3.0	-		
EN "L" Level Current	I_{ENL}	$V_{EN}=V_{SS}$	-0.1	-	0.1	μA	①
C_L Discharge Resistor ⁽⁸⁾	R_{DCHG}	$V_{IN}=6.0V$, $V_{OUT}=4.0V$, $V_{CE}=V_{SS}$	-	550	-	Ω	①

NOTE:

- *1) Unless otherwise stated, $V_{IN}=V_{OUT(T)}+1.0V$.
- *2) $V_{OUT(E)}$ = Effective output voltage (see the voltage chart)
(ie. The output voltage when " $V_{OUT(T)}+1.0V$ " is provided at the V_{IN} pin while maintaining a certain I_{OUT} value.
- *3) Characteristics of the actual $V_{OUT(E)}$ by setting output voltage is shown in the voltage chart.
- *4) $V_{OUT(T)}$: Nominal output voltage
- *5) $Vdif=\{V_{IN1}^{(7)} - V_{OUT1}^{(6)}\}$
- *6) V_{OUT1} : A voltage equal to 98% of the output voltage whenever an amply stabilized $I_{OUT}\{V_{OUT(T)}+1.0V\}$ is input.
- *7) V_{IN1} : The input voltage when V_{OUT1} appears as input voltage is gradually decreased.
- *8) For XC6415B, D, F, H series only.
XC6415A, C, E, G series discharge with only Rx1 and Rx2 resistors as shown in the BLOCK DIAGRAMS.
- *9) Each channel is measured when the other channel is turned off ($V_{EN}=V_{SS}$).

■ ELECTRICAL CHARACTERISTICS (Continued)

● Voltage Chart

NOMINAL OUTPUT VOLTAGE (V)	OUTPUT VOLTAGE (V)				LOAD REGULATION E-1 (mV)		DROPOUT VOLTAGE E-2 (mV)	
	V _{OUT(E)} 1% Accuracy		V _{OUT(E)} 2% Accuracy		ΔV _{OUT}		V _{dif}	
	MIN.	MAX.	MIN.	MAX.	TYP.	MAX.	TYP.	MAX.
V _{OUT(T)}								
0.80	0.7800	0.8200	0.7700	0.8300	10	30	500	850
0.85	0.8300	0.8700	0.8200	0.8800				
0.90	0.8800	0.9200	0.8700	0.9300				
0.95	0.9300	0.9700	0.9200	0.9800				
1.00	0.9800	1.0200	0.9700	1.0300				
1.05	1.0300	1.0700	1.0200	1.0800				
1.10	1.0800	1.1200	1.0700	1.1300				
1.15	1.1300	1.1700	1.1200	1.1800				
1.20	1.1800	1.2200	1.1700	1.2300				
1.25	1.2300	1.2700	1.2200	1.2800				
1.30	1.2800	1.3200	1.2700	1.3300				
1.35	1.3300	1.3700	1.3200	1.3800				
1.40	1.3800	1.4200	1.3700	1.4300				
1.45	1.4300	1.4700	1.4200	1.4800				
1.50	1.4800	1.5200	1.4700	1.5300				
1.55	1.5300	1.5700	1.5190	1.5810				
1.60	1.5800	1.6200	1.5680	1.6320				
1.65	1.6300	1.6700	1.6170	1.6830				
1.70	1.6800	1.7200	1.6660	1.7340				
1.75	1.7300	1.7700	1.7150	1.7850				
1.80	1.7800	1.8200	1.7640	1.8360				
1.85	1.8300	1.8700	1.8130	1.8870				
1.90	1.8800	1.9200	1.8620	1.9380				
1.95	1.9300	1.9700	1.9110	1.9890				
2.00	1.9800	2.0200	1.9600	2.0400	20	50	150	200
2.05	2.0295	2.0705	2.0090	2.0910				
2.10	2.0790	2.1210	2.0580	2.1420				
2.15	2.1285	2.1715	2.1070	2.1930				
2.20	2.1780	2.2220	2.1560	2.2440				
2.25	2.2275	2.2725	2.2050	2.2950				
2.30	2.2770	2.3230	2.2540	2.3460				
2.35	2.3265	2.3735	2.3030	2.3970				
2.40	2.3760	2.4240	2.3520	2.4480				
2.45	2.4255	2.4745	2.4010	2.4990				
2.50	2.4750	2.5250	2.4500	2.5500				
2.55	2.5245	2.5755	2.4990	2.6010				
2.60	2.5740	2.6260	2.4580	2.6520				
2.65	2.6235	2.6765	2.8970	2.7030				
2.70	2.6730	2.7270	2.6460	2.7540				
2.75	2.7225	2.7775	2.6950	2.8050				
2.80	2.7720	2.8280	2.7440	2.8560				
2.85	2.8215	2.8785	2.7930	2.9070				
2.90	2.8710	2.9290	2.8420	2.9580				
2.95	2.9205	2.9795	2.8910	3.0090				
							120	180
							110	
							95	150

ELECTRICAL CHARACTERISTICS (Continued)

● Voltage Chart (Continued)

NOMINAL OUTPUT VOLTAGE (V)	OUTPUT VOLTAGE (V)				LOAD REGULATION E-1 (mV)		DROPOUT VOLTAGE E-2 (mV)	
	V _{OUT(E)} 1% Accuracy		V _{OUT(E)} 2% Accuracy		ΔV _{OUT}		V _{dif}	
	V _{OUT(T)}	MIN.	MAX.	MIN.	MAX.	TYP.	MAX.	TYP.
3.00	2.9700	3.0300	2.9400	3.0600	20	50	95	150
3.05	3.0195	3.0805	2.9890	3.1110				
3.10	3.0690	3.1310	3.0380	3.1620				
3.15	3.1185	3.1815	3.0870	3.2130				
3.20	3.1680	3.2320	3.1360	3.2640				
3.25	3.2175	3.2825	3.1850	3.3150				
3.30	3.2670	3.3330	3.2340	3.3660				
3.35	3.3165	3.3835	3.2830	3.4170				
3.40	3.3660	3.4340	3.3320	3.4680				
3.45	3.4155	3.4845	3.3810	3.5190				
3.50	3.4650	3.5350	3.4300	3.5700				
3.55	3.5145	3.5855	3.4790	3.6210				
3.60	3.5640	3.6360	3.5280	3.6720				
3.65	3.6135	3.6865	3.5770	3.7230				
3.70	3.6630	3.7370	3.6260	3.7740				
3.75	3.7125	3.7875	3.6750	3.8250				
3.80	3.7620	3.8380	3.7240	3.8760				
3.85	3.8115	3.8885	3.7730	3.9270				
3.90	3.8610	3.9390	3.8220	3.9780				
3.95	3.9105	3.9895	3.8710	4.0290				
4.00	3.9600	4.0400	3.9200	4.0800	30	60	80	120
4.05	4.0095	4.0905	3.9690	4.1310				
4.10	4.0590	4.1410	4.0180	4.1820				
4.15	4.1085	4.1915	4.0670	4.2330				
4.20	4.1580	4.2420	4.1160	4.2840				
4.25	4.2075	4.2925	4.1650	4.3350				
4.30	4.2570	4.3430	4.2140	4.3860				
4.35	4.3065	4.3935	4.2630	4.4370				
4.40	4.3560	4.4440	4.3120	4.4880				
4.45	4.4055	4.4945	4.3610	4.5390				
4.50	4.4550	4.5450	4.4100	4.5900				
4.55	4.5045	4.5955	4.4590	4.6410				
4.60	4.5540	4.6460	4.5080	4.6920				
4.65	4.6035	4.6965	4.5570	4.7430				
4.70	4.6530	4.7470	4.6060	4.7940				
4.75	4.7025	4.7975	4.6550	4.8450				
4.80	4.7520	4.8480	4.7040	4.8960				
4.85	4.8015	4.8985	4.7530	4.9470				
4.90	4.8510	4.9490	4.8020	4.9980				
4.95	4.9005	4.9995	4.8510	5.0490				
5.00	4.9500	5.0500	4.9000	5.1000				

OPERATIONAL DESCRIPTION

<Output Voltage Control>

The voltage divided by resistors Rx1 and Rx2 is compared with the internal reference voltage by the error amplifier. The P-channel MOSFET which is connected to the V_{OUT} pin is then driven by the subsequent output signal. The output voltage at the V_{OUT} pin is controlled and stabilized by a system of negative feedback. The current limit circuit and short protect circuit operate in relation to the level of output current. Further, the IC's internal circuitry can be shutdown via the EN pin's signal.

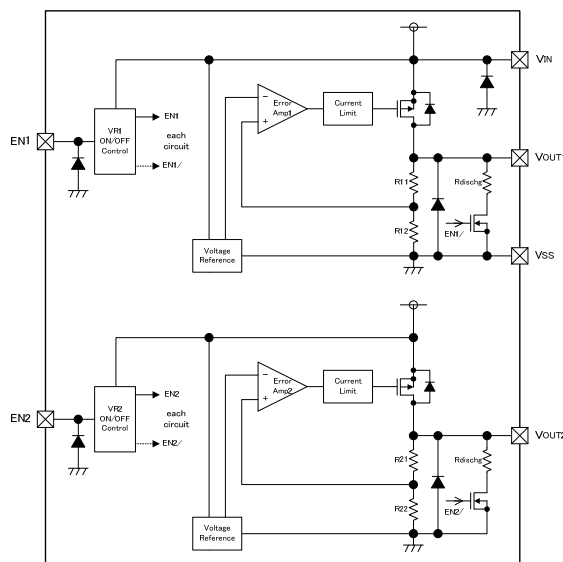

< XC6415BB Series >

<CL Auto-Discharge Function>

XC6415B, D, F, H series can quickly discharge the electric charge at the output capacitor (C_L), when a low signal to the EN pin, which enables a whole IC circuit put into OFF state, is inputted via the N-channel transistor located between the V_{OUT} pin and the V_{SS} pin (cf. BLOCK DIAGRAM). The C_L discharge resistance is set to 550 Ω when V_{IN} is 6.0V (TYP.) and V_{OUT} is 4.0V (TYP.). Moreover, discharge time of the output capacitor (C_L) is set by the C_L auto-discharge resistance (R) and the output capacitor (C_L). By setting time constant of a C_L auto-discharge resistance value [R] and an output capacitor value (C_L) as τ ($\tau = C \times R$), the output voltage after discharge via the N channel transistor is calculated by the following formulas.

$$V = V_{OUT} \times e^{-t/\tau}, \quad \text{or } t = \tau \ln (V_{OUT(E)} / V)$$

(V : Output voltage after discharge, V_{OUT(E)} : Output voltage, t: Discharge time,
 τ : C_L auto-discharge resistance R × Output capacitor (C_L) value C)

C_L high-speed discharge function can be set by each regulator.

<Current Limiter, Short-Circuit Protection>

The XC6415 series includes a fold-back circuit, which aid the operations of the current limiter and circuit protection. When the load current reaches the current limit level, the fold-back circuit operates and output voltage drops. As a result of this drop in output voltage, output current also decreases. When the output pin is shorted, a current of about 20mA flows.

<EN Pin>

The IC's internal circuitry can be shutdown via the signal from the EN pin with the XC6415 series. In shutdown mode, output at the V_{OUT} pin will be pulled down to the V_{SS} level via Rx1 & Rx2. However, as for the XC6415B, D, F, H series, the C_L auto-discharge resistor is connected in parallel to Rx1 and Rx2 while the power supply is applied to the V_{IN} pin. Therefore, time until the V_{OUT} pin reaches the V_{SS} level becomes short. The EN pin is CMOS input, but in case the EN pin with pulled down resistor, the EN input current will be increase when the IC operates. Also, in case of the EN pin without pulled down resistor, the output voltage becomes unstable when the EN pin is left open. If this IC is used with the correct output voltage for the EN pin, the logic is fixed and the IC will operate normally. However, supply current may increase as a result of through current in the IC's internal circuitry when medium voltage is input.

NOTES ON USE

1. Please use this IC within the stated absolute maximum ratings. The IC is liable to malfunction should the ratings be exceeded.
2. Where wiring impedance is high, operations may become unstable due to noise and/or phase lag depending on output current. Please wire the input capacitor (C_{IN}) and the output capacitor (C_L) as close to the IC as possible.

TEST CIRCUITS

● Circuit ①

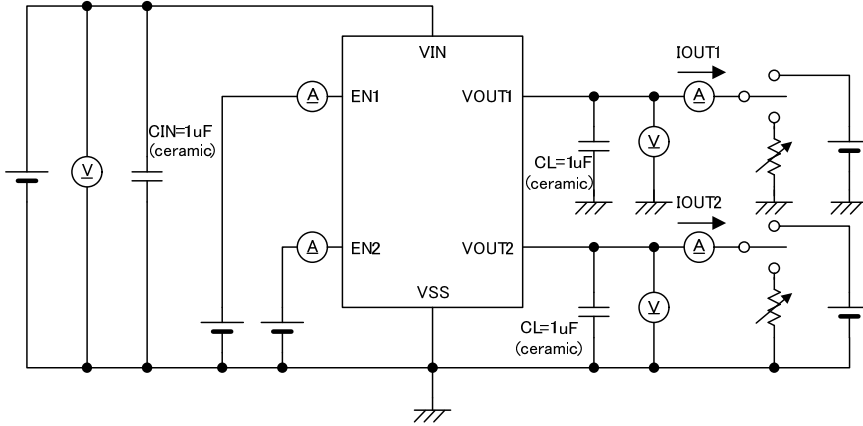

● Circuit ②

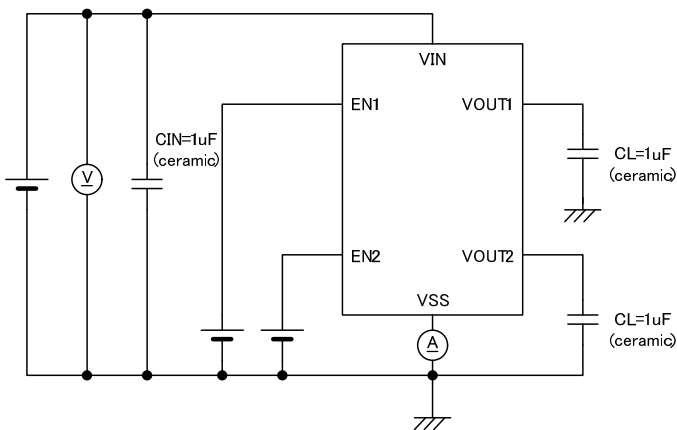

● Circuit ③

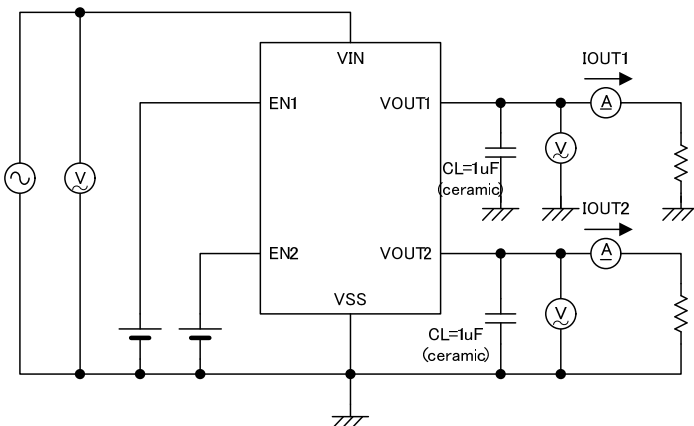

TYPICAL PERFORMANCE CHARACTERISTICS

* EN Voltage condition: Unless otherwise stated, $V_{EN}=V_{IN}$

(1) OutputVoltage vs. OutputCurrent

XC6415($V_{OUT}=0.8V$)

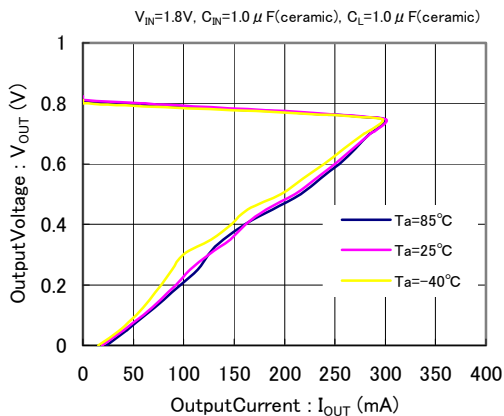

XC6415($V_{OUT}=0.8V$)

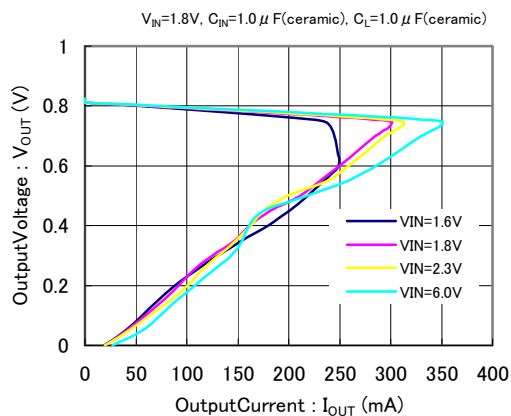

XC6415($V_{OUT}=1.5V$)

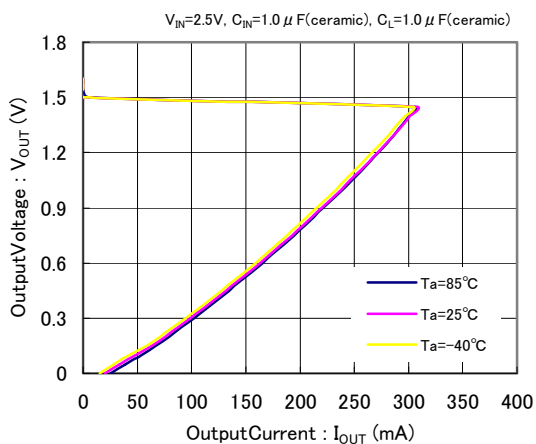

XC6415($V_{OUT}=1.5V$)

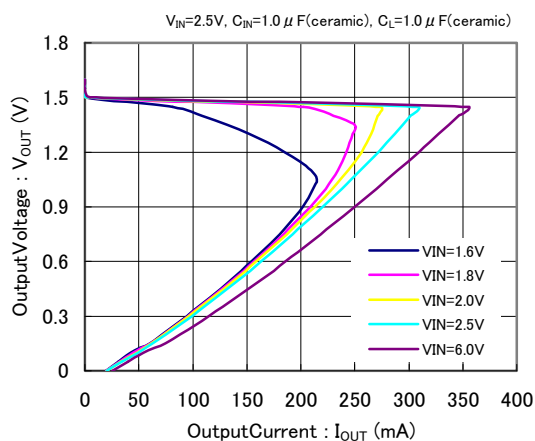

XC6415($V_{OUT}=2.8V$)

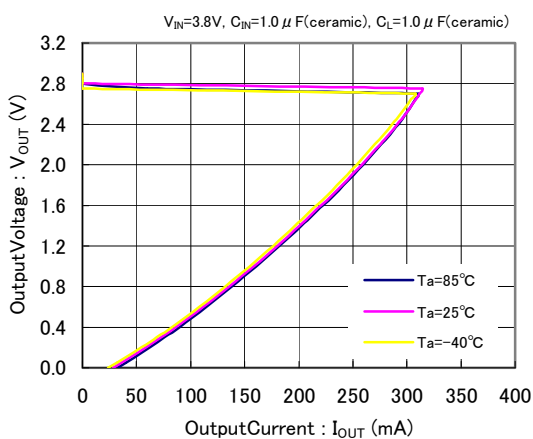

XC6415($V_{OUT}=2.8V$)

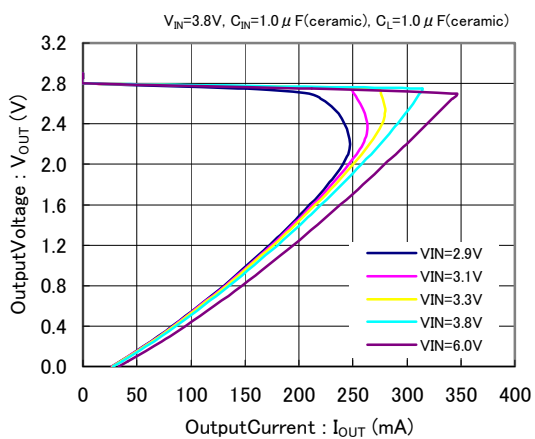

TYPICAL PERFORMANCE CHARACTERISTICS (Continued)

(1) OutputVoltage vs. OutputCurrent (Continued)

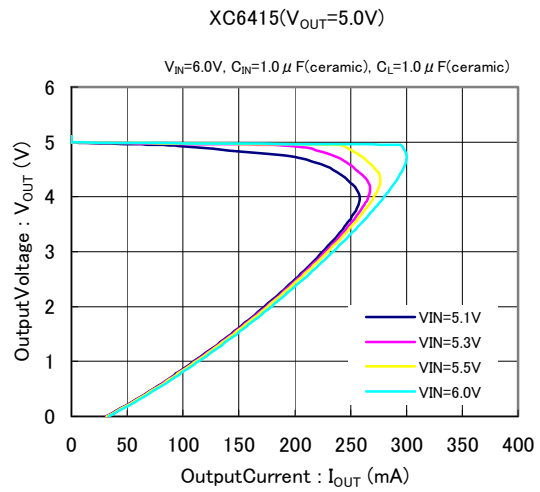
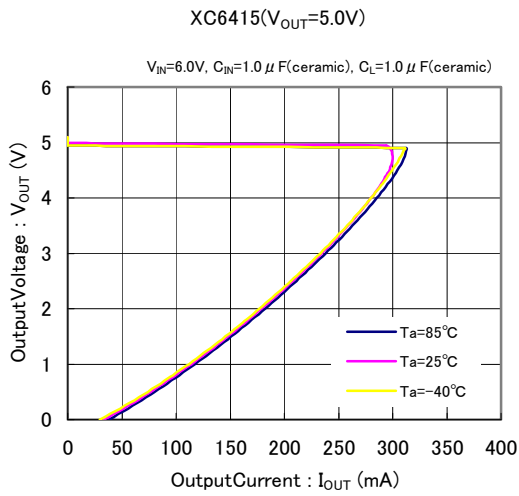

(2) OutputVoltage vs. InputVoltage

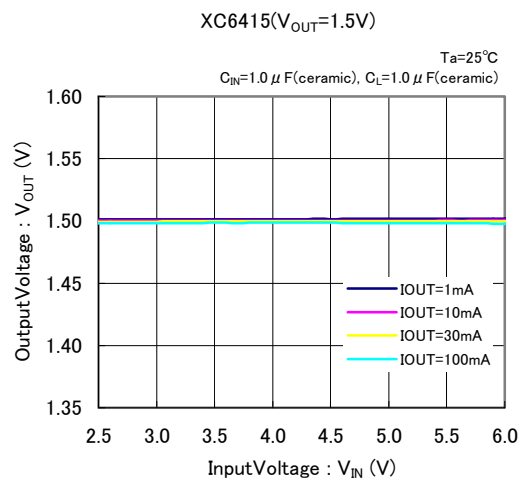
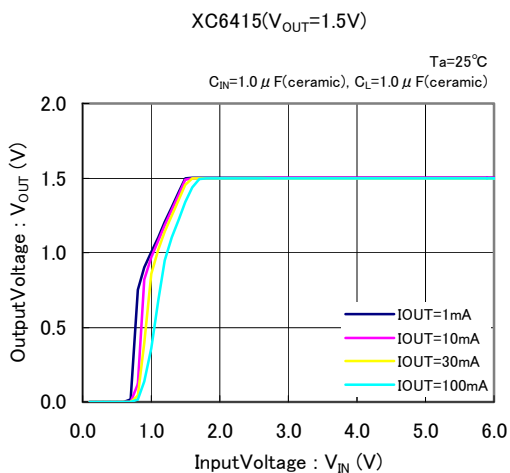
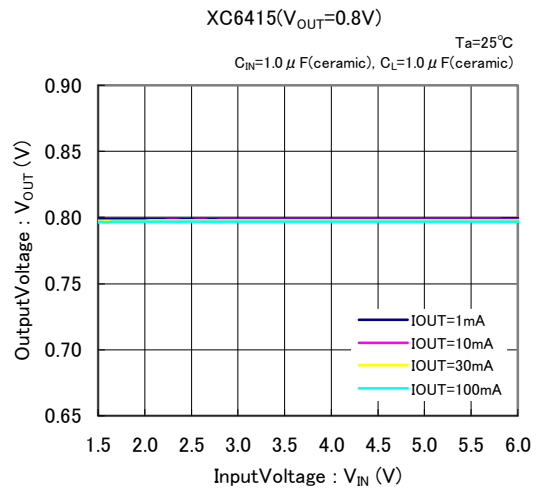
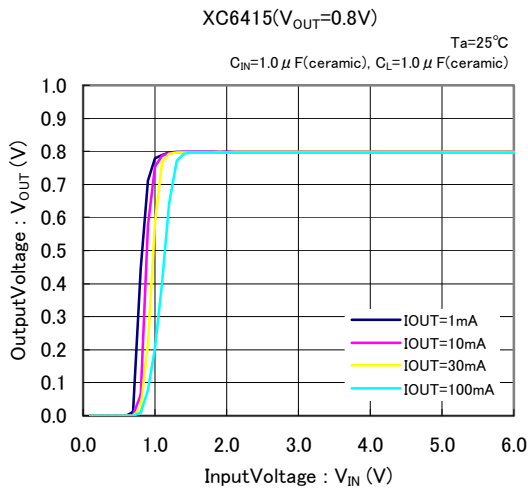

■ TYPICAL PERFORMANCE CHARACTERISTICS (Continued)

(2) OutputVoltage vs. InputVoltage (Continued)

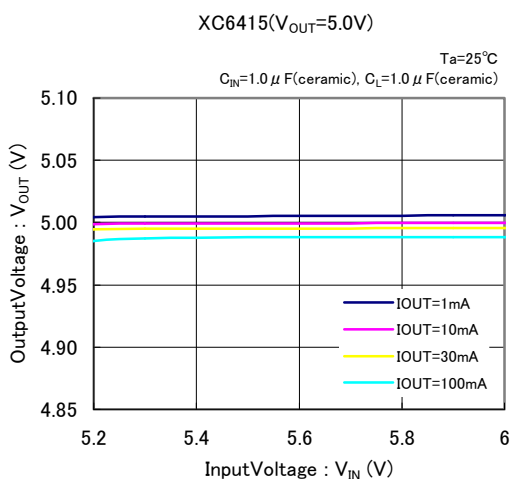
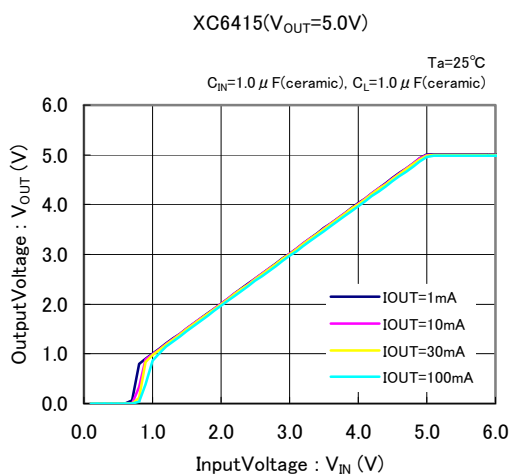
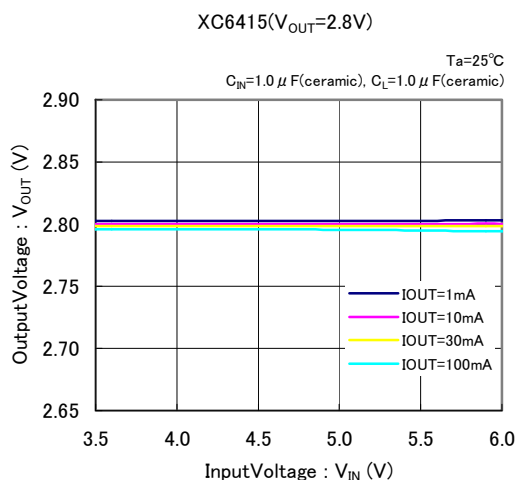
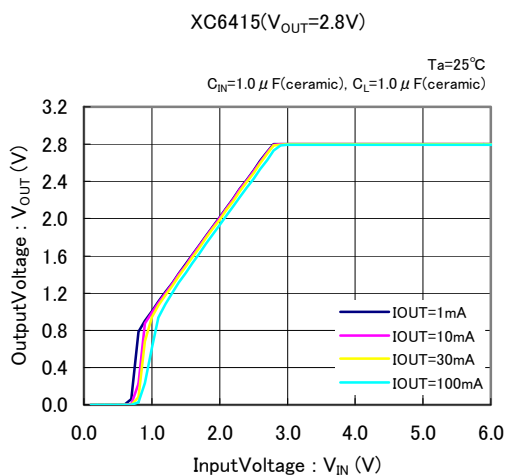

(3) DropoutVoltage vs. OutputCurrent

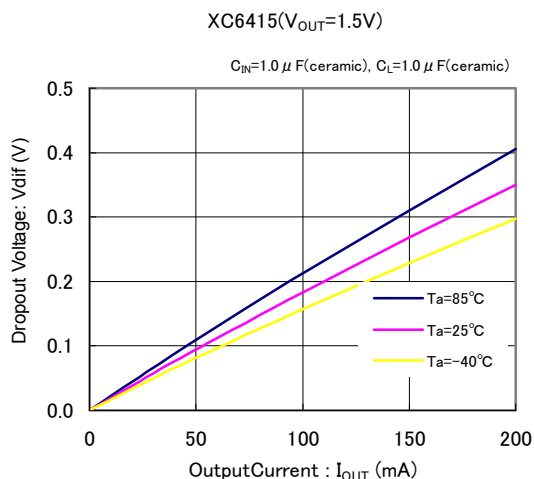
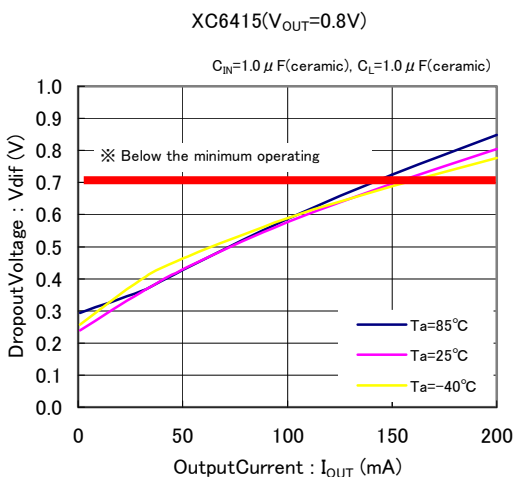

TYPICAL PERFORMANCE CHARACTERISTICS (Continued)

(3) Dropout Voltage vs. Output Current (Continued)

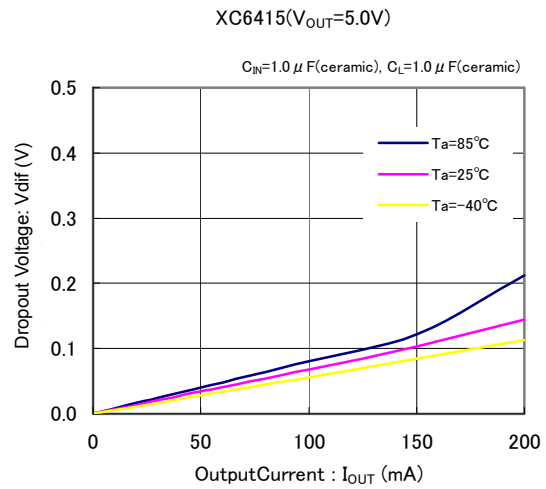
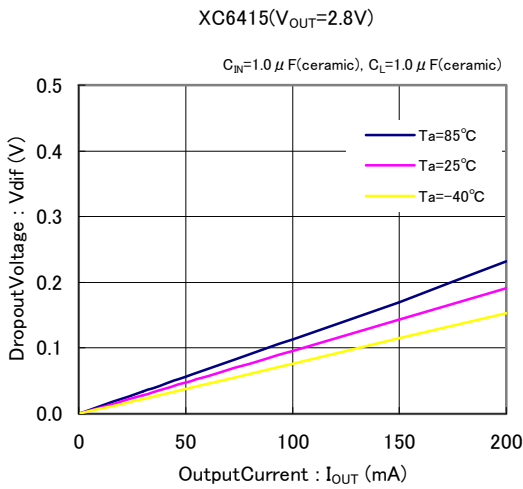

(4) Supply Current vs. Input Voltage

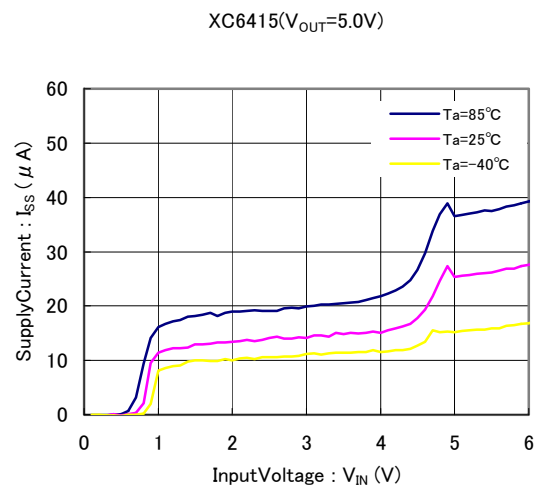
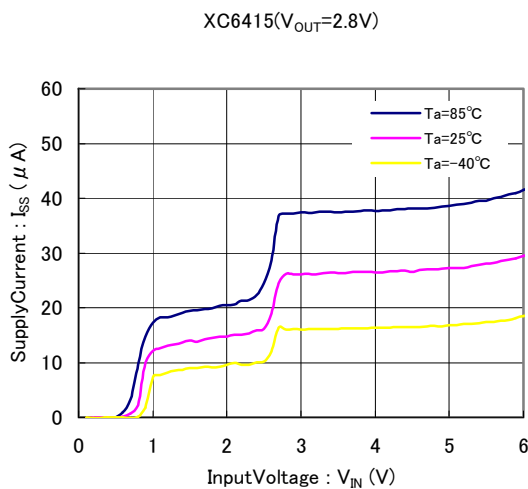
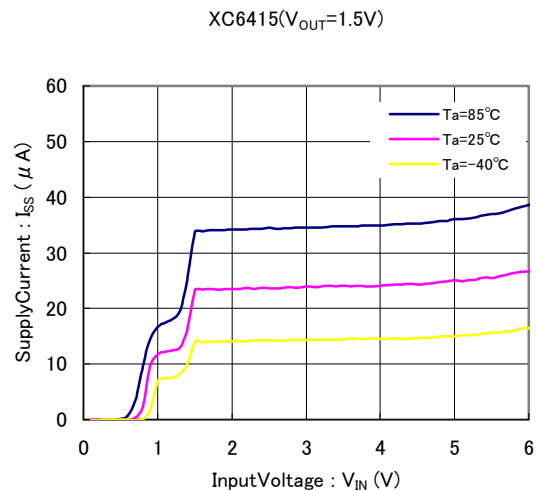
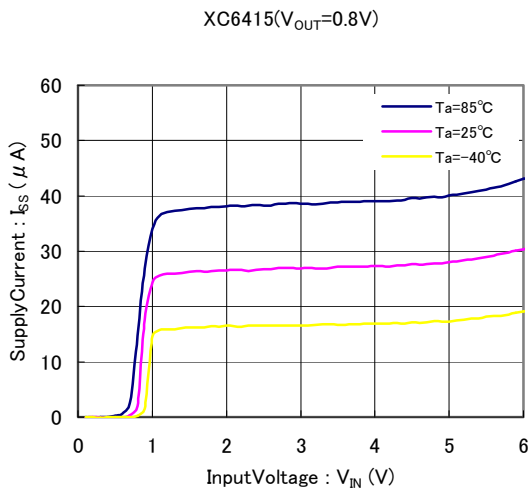

TYPICAL PERFORMANCE CHARACTERISTICS (Continued)

(5) Output Voltage vs. Ambient Temperature

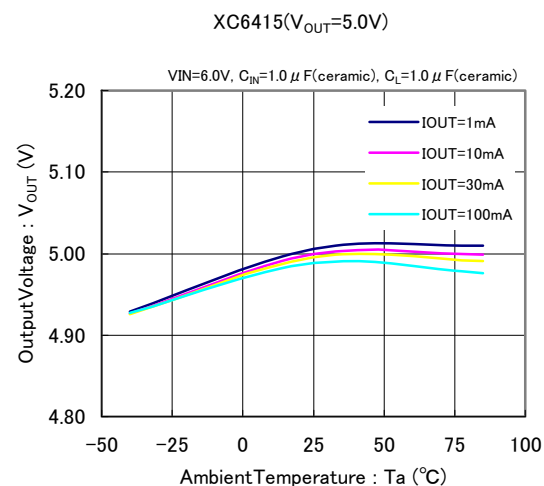
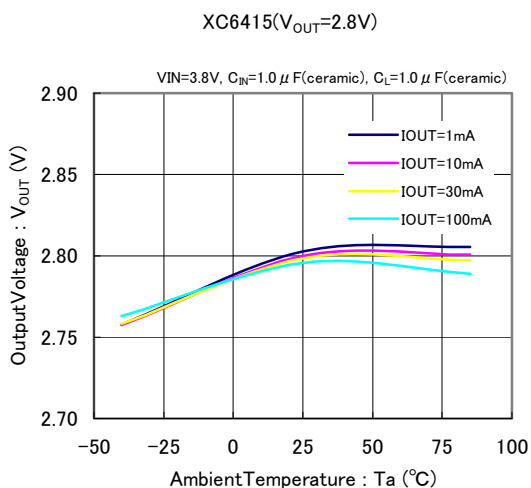
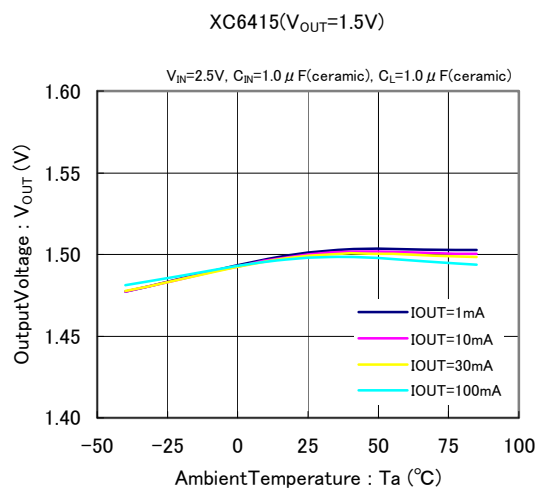
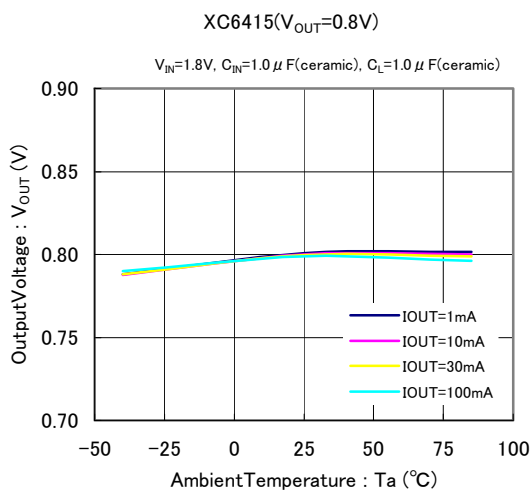

(6) Supply Current vs. Ambient Temperature

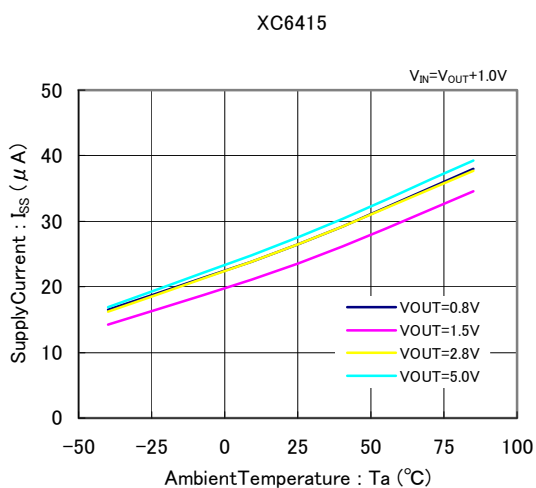

(7) EN Threshold Voltage vs. Ambient Temperature

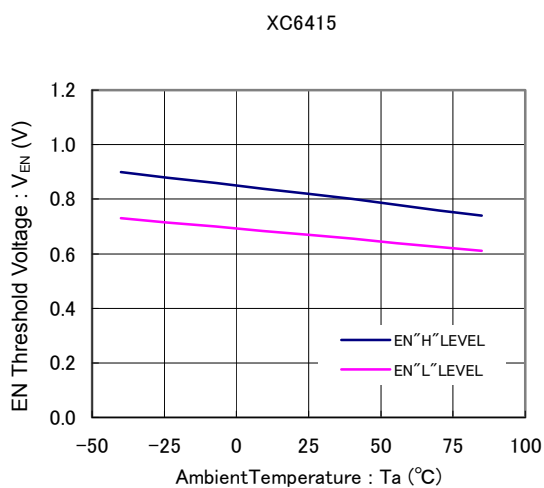

TYPICAL PERFORMANCE CHARACTERISTICS (Continued)

(8) Rising Response Time

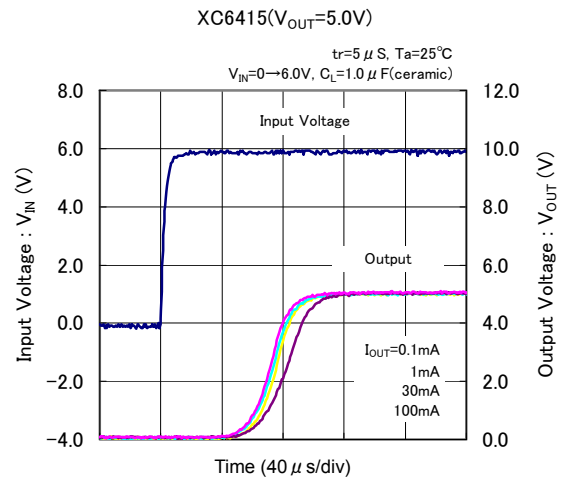
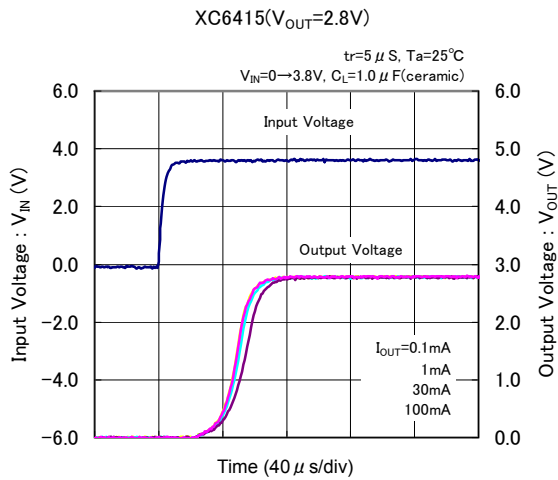
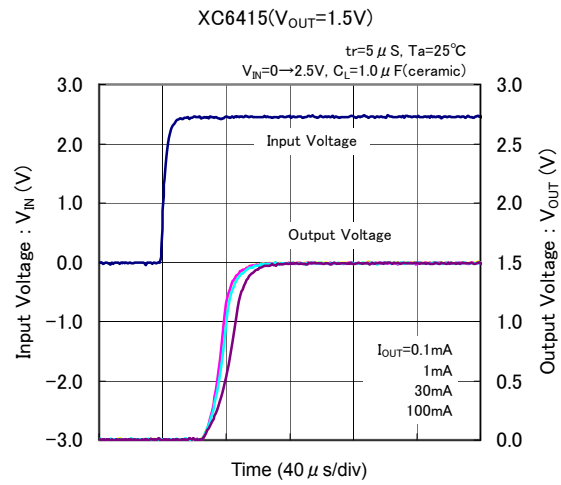
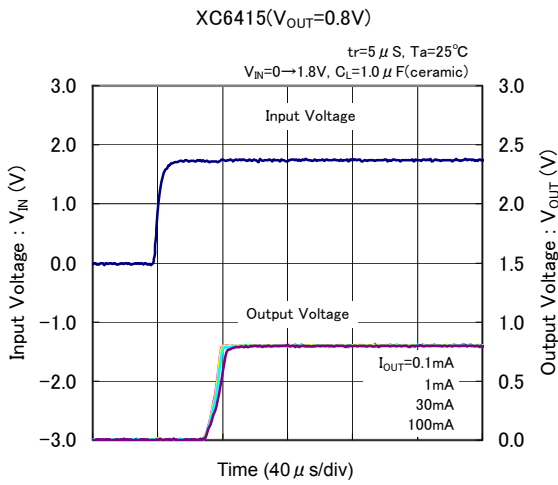

(9) Input Transient Response

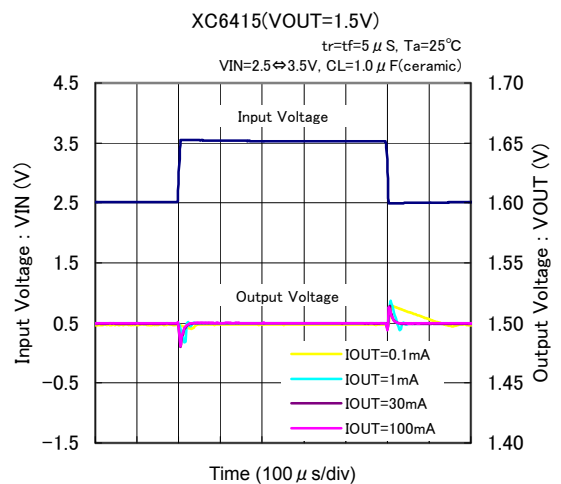
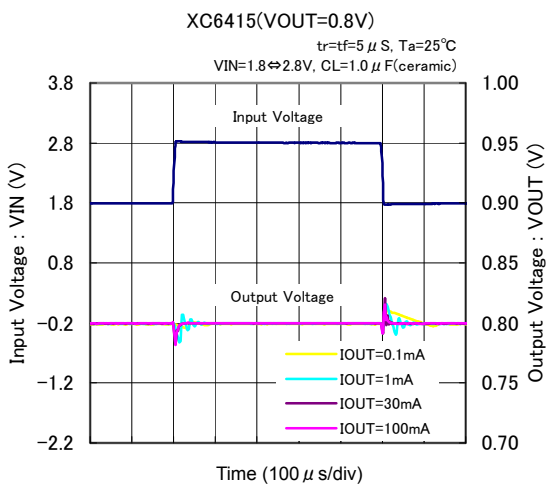

■ TYPICAL PERFORMANCE CHARACTERISTICS (Continued)

(9) Input Transient Response (Continued)

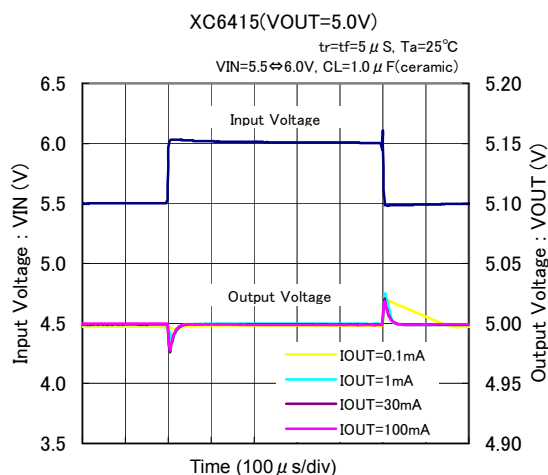
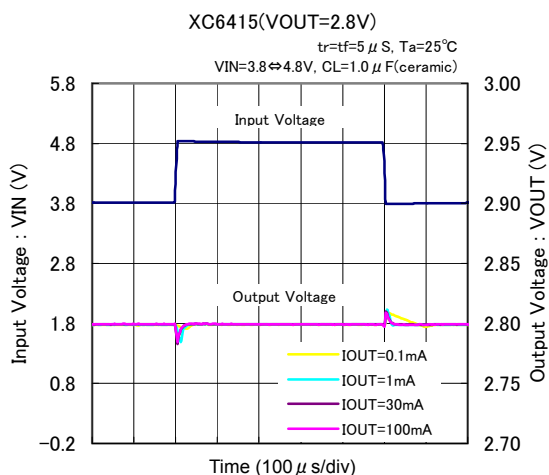

(10) Load Transient Response

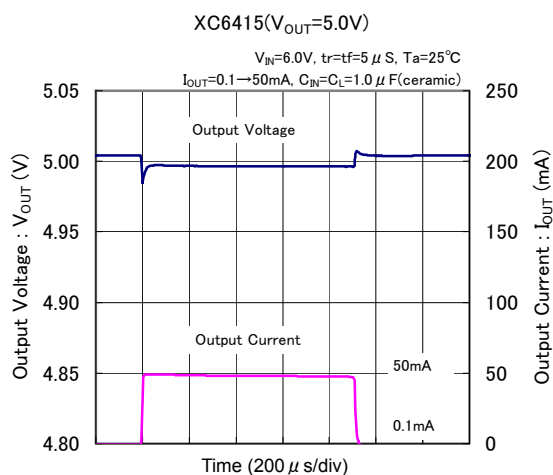
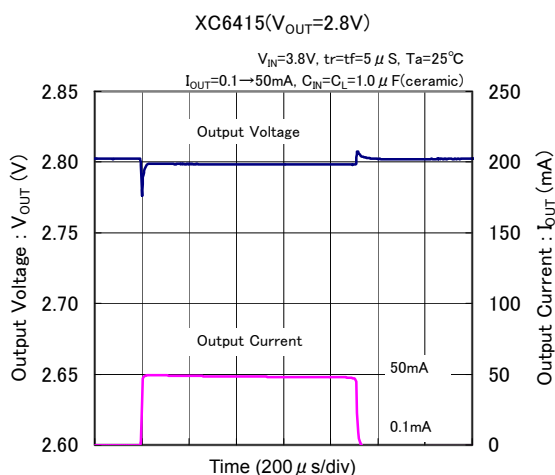
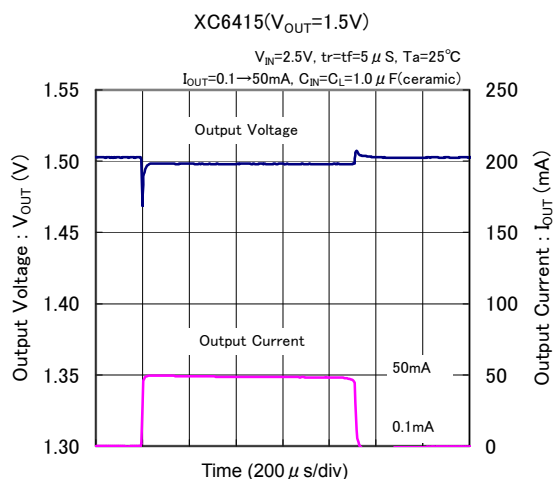
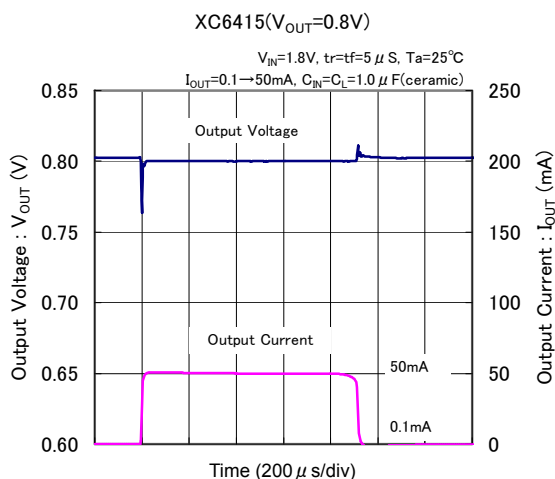

TYPICAL PERFORMANCE CHARACTERISTICS (Continued)

(11) EN Rising Response Time

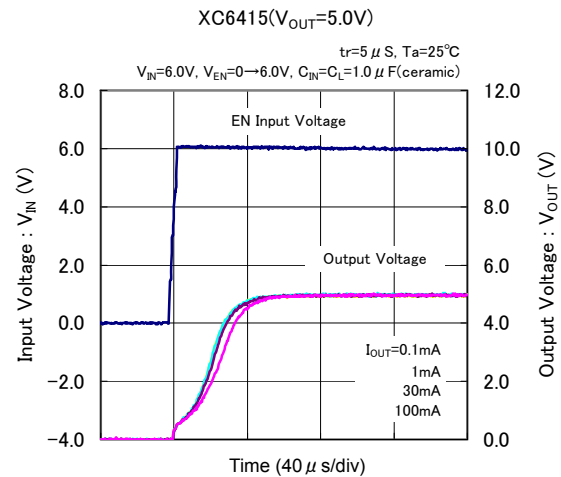
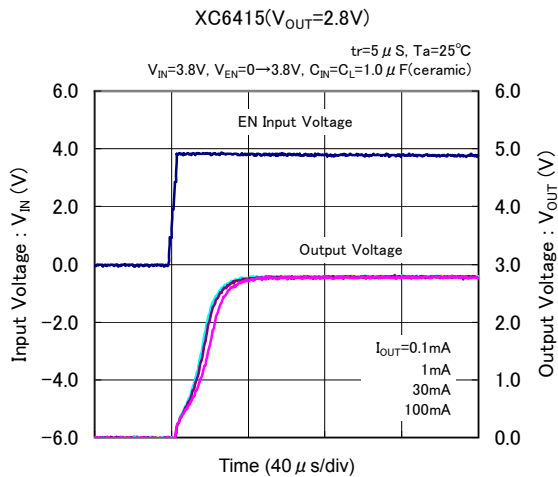
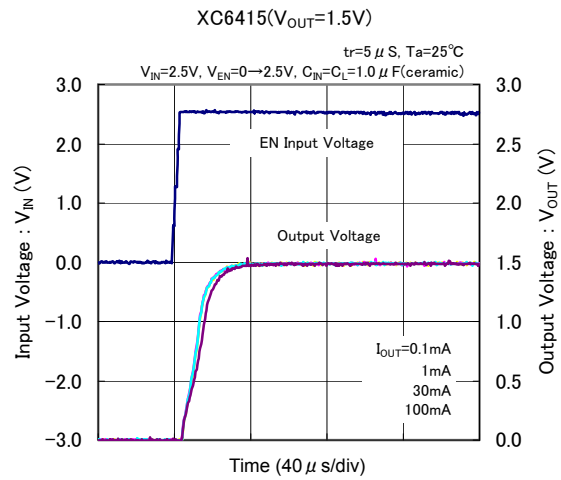
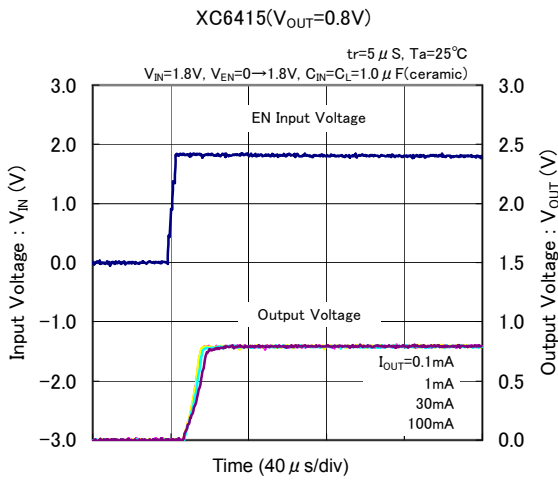

(12) Ripple Rejection Rate

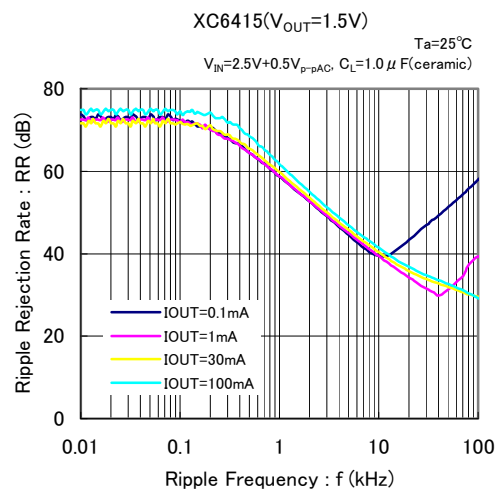
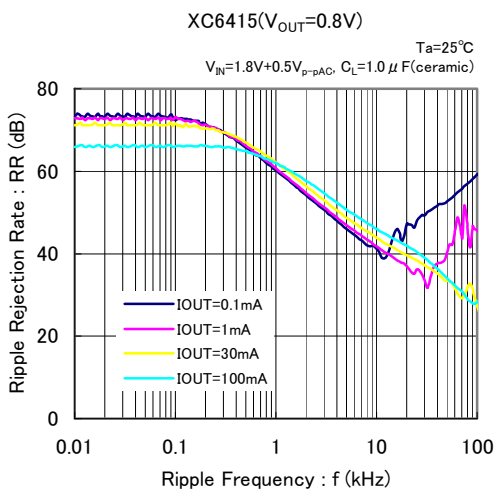

■ TYPICAL PERFORMANCE CHARACTERISTICS (Continued)

(12) Ripple Rejection Rate (Continued)

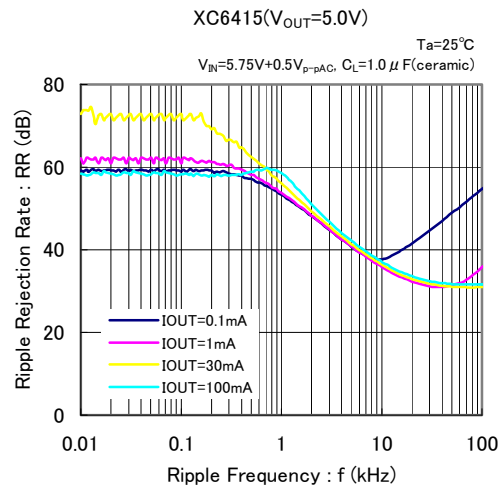
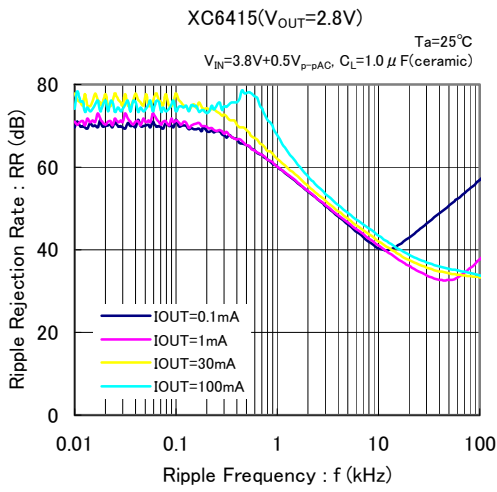

(13) Cross Talk

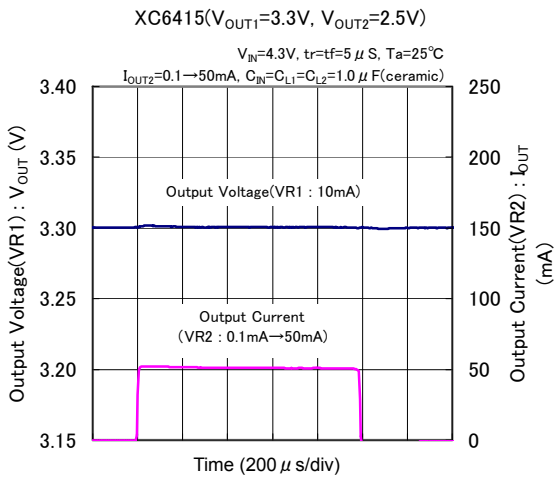

PACKAGING INFORMATION

●SOT-26

(unit : mm)

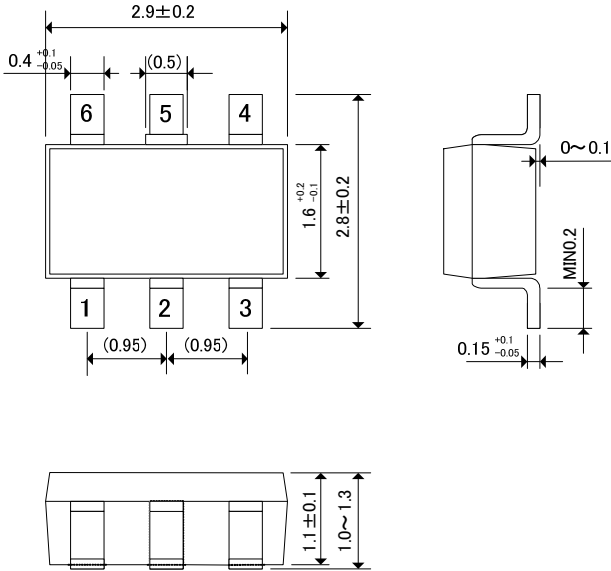

●USP-6C

(unit : mm)

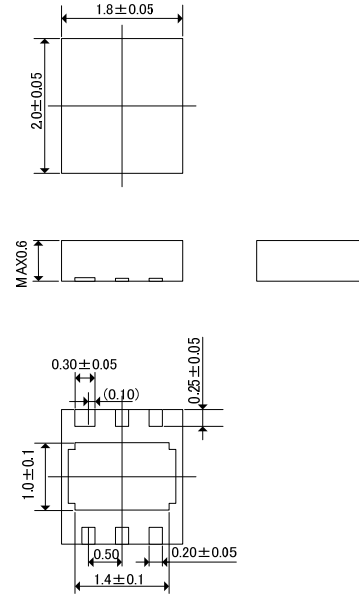

●USP-6C Reference Pattern Layout

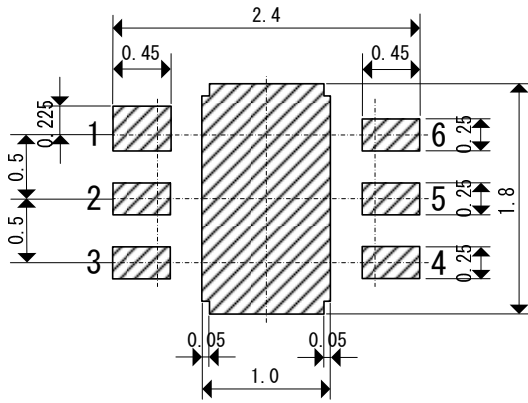

●USP-6C Reference Metal Mask Design

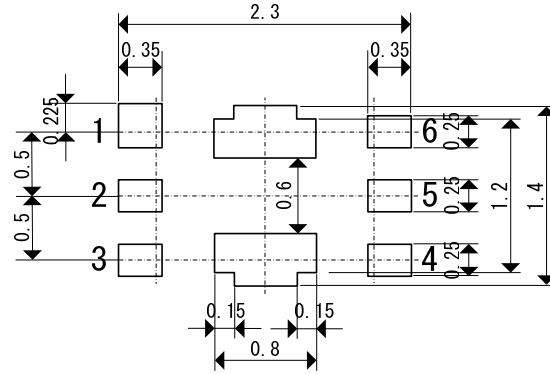

PACKAGING INFORMATION (Continued)

●USPN-6

(unit : mm)

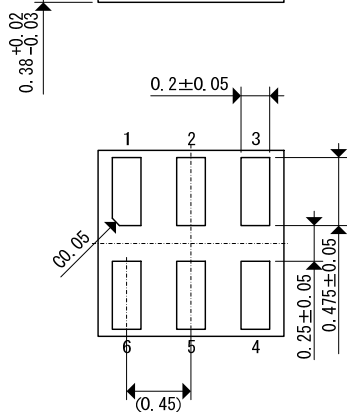
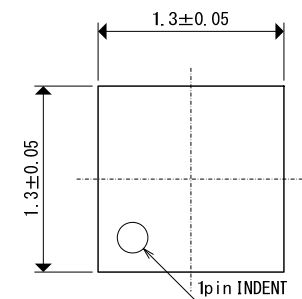

●USPN-6 Reference Pattern Layout

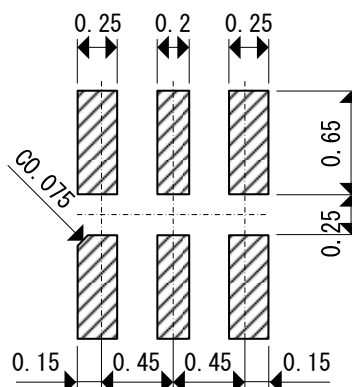

●USPN-6 Reference Metal Mask Design

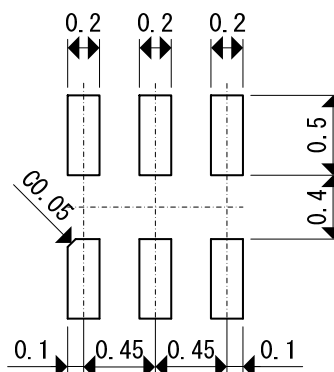

MARKING RULE

●SOT-26, USP-6C

SOT-26

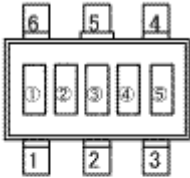

① represents product series

MARK	PRODUCT SERIES
1	XC6415xxxxx

②③ represents internal sequential number

01~09, 10~99, A0~A9, B0~, B9~, Z9~repeated.
(G, I, J, O, Q, W excluded)

④⑤ represents production lot number

01~09, 10, 11~99, 0A~0Z, 1A~9Z, A0~Z9, AA~ZZ repeated.
(G, I, J, O, Q, W excluded)
*No character inversion used.

USP-6C

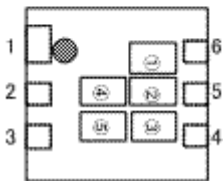

●USPN-6

USPN-6

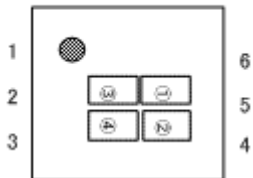

① represents product series

MARK	PRODUCT SERIES
1	XC6415xxxxx

② represents internal sequential number

0, 1~9, A, B~Z repeated.
(G, I, J, O, Q, W excluded)

*Once the sequential number of the mark② is used to Z, a mark① symbol will be added.

③④ represents production lot number

01~09, 10, 11~99, 0A~0Z, 1A~9Z, A0~Z9, AA~ZZ repeated.
(G, I, J, O, Q, W excluded)
*No character inversion used.

■ PACKAGING INFORMATION (Continued)

● USP-6C Power Dissipation

Power dissipation data for the USP-6C is shown in this page.
The value of power dissipation varies with the mount board conditions.
Please use this data as one of reference data taken in the described condition.

1. Measurement Condition (Reference data)

- Condition: Mount on a board
- Ambient: Natural convection
- Soldering: Lead (Pb) free
- Board: Dimensions 40 x 40 mm (1600 mm² in one side)
Copper (Cu) traces occupy 50% of the board area
In top and back faces
Package heat-sink is tied to the copper traces
- Material: Glass Epoxy (FR-4)
- Thickness: 1.6 mm
- Through-hole: 4 x 0.8 Diameter

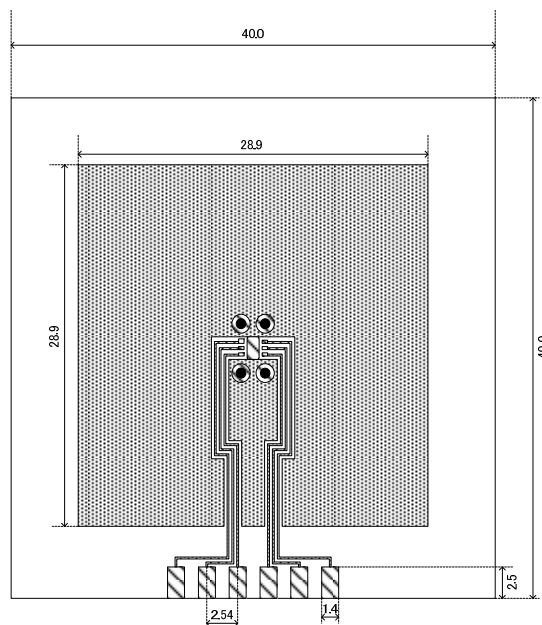

Evaluation Board (Unit: mm)

2. Power Dissipation vs. Ambient temperature

Board Mount ($T_j \text{ max} = 125^\circ\text{C}$)

Ambient Temperature ($^\circ\text{C}$)	Power Dissipation P_d (mW)	Thermal Resistance ($^\circ\text{C}/\text{W}$)
25	1000	100
85	400	

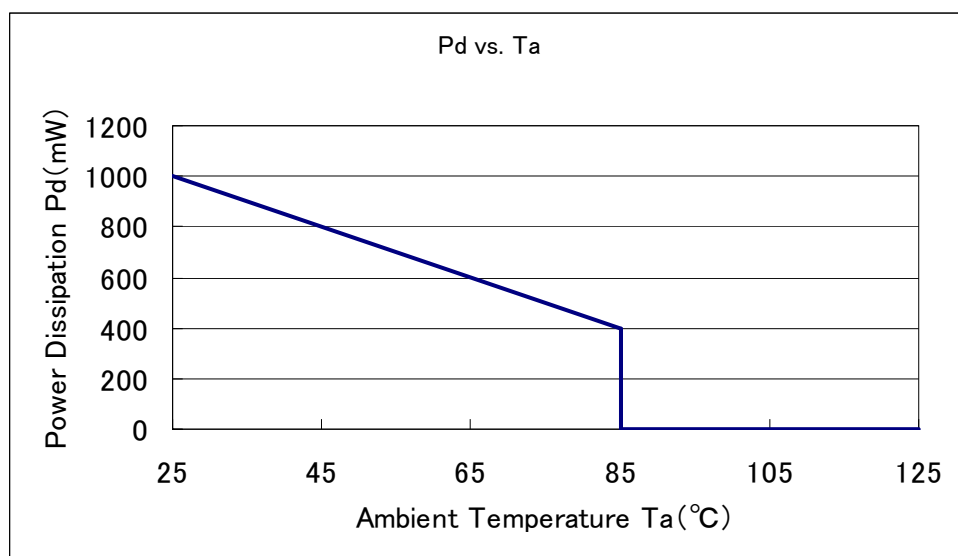

1. The products and product specifications contained herein are subject to change without notice to improve performance characteristics. Consult us, or our representatives before use, to confirm that the information in this datasheet is up to date.
2. We assume no responsibility for any infringement of patents, patent rights, or other rights arising from the use of any information and circuitry in this datasheet.
3. Please ensure suitable shipping controls (including fail-safe designs and aging protection) are in force for equipment employing products listed in this datasheet.
4. The products in this datasheet are not developed, designed, or approved for use with such equipment whose failure or malfunction can be reasonably expected to directly endanger the life of, or cause significant injury to, the user.
(e.g. Atomic energy; aerospace; transport; combustion and associated safety equipment thereof.)
5. Please use the products listed in this datasheet within the specified ranges.
Should you wish to use the products under conditions exceeding the specifications, please consult us or our representatives.
6. We assume no responsibility for damage or loss due to abnormal use.
7. All rights reserved. No part of this datasheet may be copied or reproduced without the prior permission of TOREX SEMICONDUCTOR LTD.

TOREX SEMICONDUCTOR LTD.

单击下面可查看定价，库存，交付和生命周期等信息

[>>Torex Semiconductor\(特瑞仕\)](#)