

NOTES:

1. ROHS COMPLIANT
2. HEADER: DAP (DIALLYL PHTHALATE) WITH FLAMMABILITY RATING UL 94V-0 OR BETTER.
3. STORAGE TEMPERATURE: -50°C TO +125°C
4. COMPLIANCE TO J-STD:
 - A. J-STD-002: SOLDERABILITY AT 245°C REFLOW PROFILE
 - B. J-STD-020: LEVEL 1, NO MOISTURE SENSITIVE
 - C. J-STD-075: R7, 245°C MAXIMUM THROUGH REFLOW SOLDER
5. TO ORDER TAPE & REEL PACKAGING ADD A "T" SUFFIX TO THE PART NUMBER(i.e HXXXXXXXXNL BECOMES HXXXXXXXXNLT).
6. MEETS AEC-Q200 REQUIREMENTS

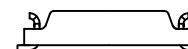
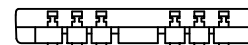
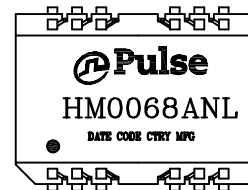

FINAL OUTLINE

© Copyright, 2016. Pulse Electronics Corp. All rights reserved. Pulse confidential & proprietary. (09/05/16)

PRODUCT DESCRIPTION	TLA DRAWING	PS DRAWING	SHEET	PART NO.	DATASHEET REV.
MDL,SIN,100D,1:1,SM,TU	HM0068ANL-10	PS-2288.001-A	1 OF 3	HM0068ANL	E

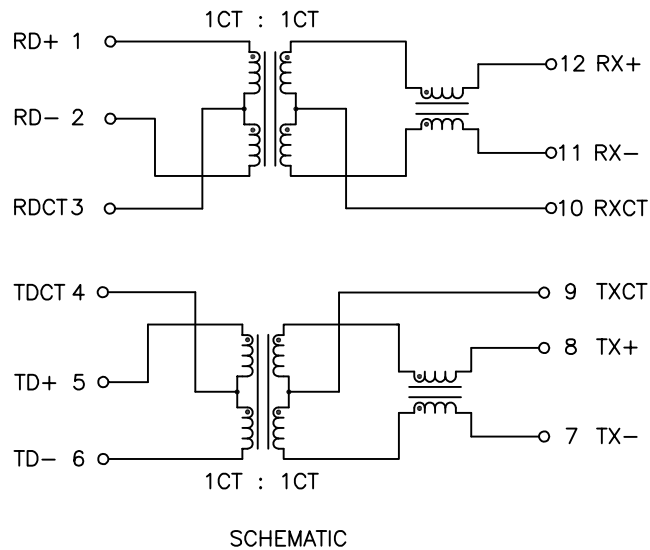

ELECTRICAL CHARACTERISTICS AT +25°C UNLESS OTHER SPECIFIED
MEETS IEEE 802.3 SPECIFICATION

PARAMETER	SPECIFICATIONS	
OPERATING TEMPERATURE	-40°C TO +105°C	
URNS RATIO	1 : 1 ±2%	
POLARITY	PER SCHEMATIC	
INSERTION LOSS	100 KHz	1-125 MHz
	-1.2 dB MAX	-0.2-0.002*f ^{1.4} dB MAX
RETURN LOSS (Z OUT = 100 OHM ±15%)	.1-40 MHz	40-100 MHz
	-16 dB MIN	-10+20*LOG ₁₀ (f/80 MHz) dB MIN
INDUCTANCE (OCL) (MEDIA SIDE)	350 uH MIN (MEASURED AT 100 KHz, 100 mVRMS) (AND WITH 8 mA DC BIAS)	
CROSSTALK, ADJACENT CHANNELS	1 MHz	10-100 MHz
	-50 dB MIN	-55+22*LOG ₁₀ (f/10) dB MIN
COMMON MODE REJECTION RATIO	2 MHz	30-200 MHz
	-42 dB MIN	-15+20*LOG ₁₀ (f/200) dB MIN
DC RESISTANCE, 1/2 WINDING	.65 OHMS MAX	
DC RESISTANCE IMBALANCE	±.065 OHMS MAX (CENTER TAP SYMMETRY)	
INPUT - OUTPUT ISOLATION	1500 VRMS MIN @ 60 SECONDS	

NOTE: f IS FREQUENCY IN MHz.

© Copyright, 2016. Pulse Electronics Corp. All rights reserved. Pulse confidential & proprietary. (09/05/16)

PRODUCT DESCRIPTION
MDL,SIN,100D,1:1,SM,TU

TLA DRAWING
HM0068ANL-10

PS DRAWING
PS-2288.001-A

SHEET
2 OF 3

PART NO.
HM0068ANL

DATASHEET REV.
E

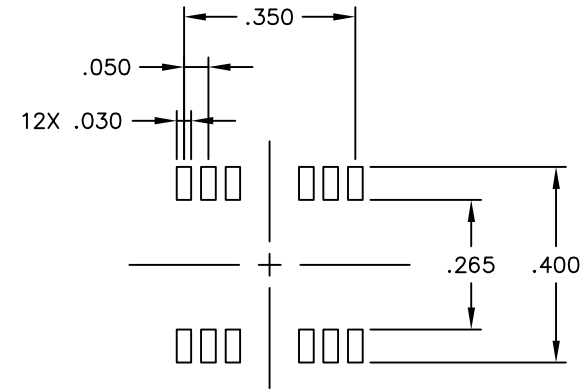
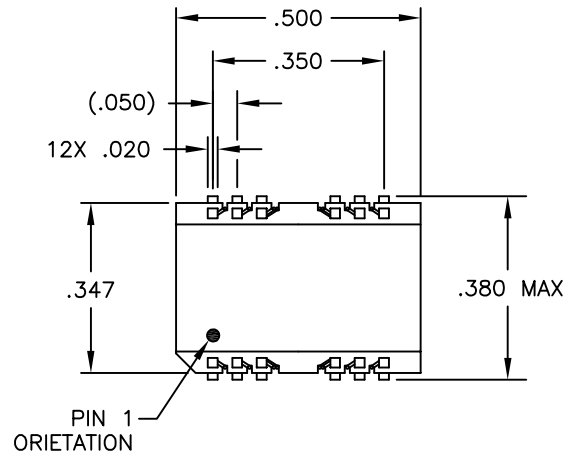

SUGGESTED LAND PATTERN

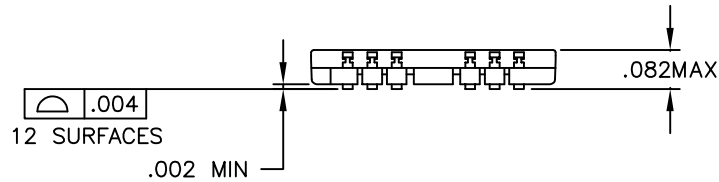

(WASH AREA: THE LOWEST POINT OF FG TO SITTING PLANE)

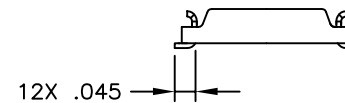

DIMENSIONS ARE IN INCHES WITH THE FOLLOWING TOLERANCES:
.XX = ±.01
.XXX = ±.005

© Copyright, 2016. Pulse Electronics Corp. All rights reserved. Pulse confidential & proprietary. (09/05/16)

PRODUCT DESCRIPTION	TLA DRAWING	PS DRAWING	SHEET	PART NO.	DATASHEET REV.
MDL,SIN,100D,1:1,SM,TU	HM0068ANL-10	PS-2288.001-A	3 OF 3	HM0068ANL	E

单击下面可查看定价，库存，交付和生命周期等信息

[>>Pulse Electronics\(普思\)](#)