

## 300mA Small High Speed Dual LDO Regulator, Built-in Inrush Current Protection

### GENERAL DESCRIPTION

The XC6421 series is an ultra small CMOS dual LDO regulator, mounting 300mA 2-channel small high speed LDO. The series features high accuracy, high ripple rejection and low dropout voltage. The series is capable of high density board installation by the ultra small package of two low on-resistance regulators. Both output accuracies are  $\pm 1\%$  by laser trimming.

Each regulator can be turned off independently to be in stand-by mode by controlling EN pin. In this state, the electric charge at the output capacitor ( $C_L$ ) is discharged via the internal auto-discharge switch, and as a result the  $V_{OUT}$  voltage quickly returns to the  $V_{SS}$  level. The output stabilization capacitor ( $C_L$ ) is also compatible with low ESR ceramic capacitors. The high level of output stability is maintained even during frequent load fluctuations, due to the excellent transient response performance.

Over current protection circuit and over heat protection circuit are mounted, these circuits start working when output current reaches junction temperature or limit current. The two regulators are completely isolated so that a cross talk during load fluctuations is minimized

### APPLICATIONS

- Smart phones / Mobile phones
- Portable game consoles
- Digital audio equipments
- Digital still cameras / Camcorders

### FEATURES

- |                               |   |
|-------------------------------|---|
| Maximum Output Current        | : 300mA   |
| Operating Voltage Range       | : 1.6V ~ 5.5V   |
| Output Voltages               | : 1.2V ~ 3.6V (0.05V increments)  |
| Output Accuracy               | : $\pm 1\%$ ( $V_{OUT} = 2.00V$ )<br>$\pm 20mV$ ( $V_{OUT} = 1.95V$ )                                       |
| Dropout Voltage               | : 210mV@ $I_{OUT}=300mA$ ( $V_{OUT}=3.0V$ )   |
| Low Power Consumption         | : 90 $\mu A$ / ch (TYP.)  |
| Stand-by Current              | : 0.1 $\mu A$   |
| Ripple Rejection              | : 75dB@1kHz   |
| ON/OFF Control                | : Active High<br>$C_L$ Discharge  |
| Protection                    | : Current Limit 450mA (TYP.)<br>Short Circuit 125mA (TYP.)<br>Inrush Current Protection<br>Thermal Shutdown |
| Low ESR Capacitor             | : 1.0 $\mu F$ Ceramic Capacitor   |
| Operating Ambient Temperature | : -40 ~ +85   |
| Package                       | : USP-6C  |
| Environmentally Friendly      | : EU RoHS Compliant, Pb Free  |

### TYPICAL APPLICATION CIRCUITS

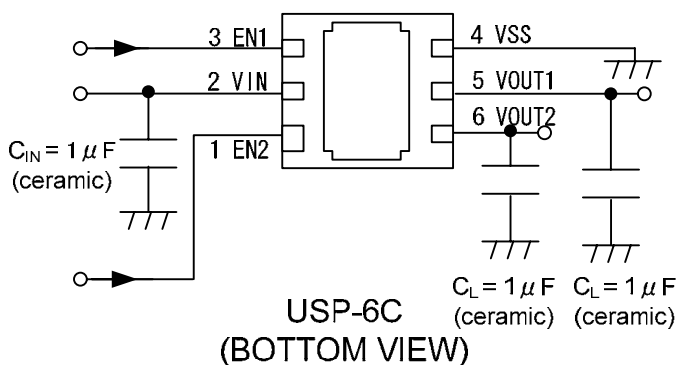

### TYPICAL PERFORMANCE CHARACTERISTICS

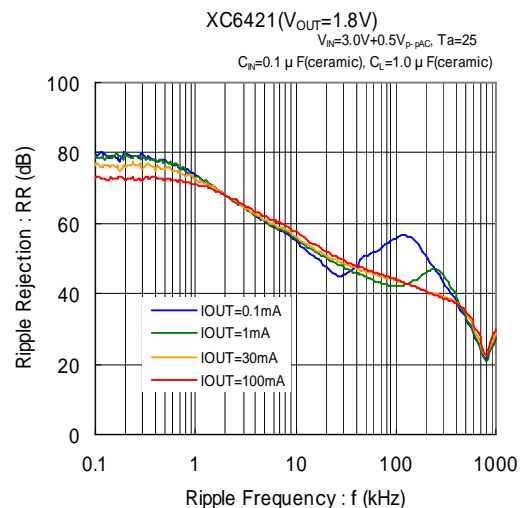

## PIN CONFIGURATION

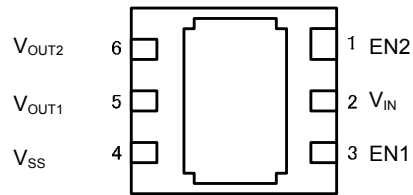

USP-6C  
(BOTTOM VIEW)

\* The dissipation pad for the USP-6C package should be solder-plated in recommended mount pattern and metal masking to enhance mounting strength and heat release. If the pad needs to be connected to other pins, it should be connected to the V<sub>SS</sub> (No. 4) pin.

## PIN ASSIGNMENT

PIN NUMBER	PIN NAME	FUNCTIONS
USP-6C		
1	EN2	ON/OFF Control 2
2	V <sub>IN</sub>	Power Input
3	EN1	ON/OFF Control 1
4	V <sub>SS</sub>	Ground
5	V <sub>OUT1</sub>	Output 1
6	V <sub>OUT2</sub>	Output 2

## PRODUCT CLASSIFICATION

### Ordering Information

XC6421 \_\_\_\_\_ - (\*)

DESIGNATOR	ITEM	SYMBOL	DESCRIPTION
	Basic Function	A	EN1: Active High , EN2: Active High Built-in Thermal Shutdown Inrush Current Protection V <sub>OUT1</sub> : C <sub>L</sub> Discharge, V <sub>OUT2</sub> : C <sub>L</sub> Discharge
	Enable Pin	B	EN1: With Pull-down EN2: With Pull-down
	Output Voltage	01 ~	See the chart below
-	Package (Order Unit)	ER-G	USP-6C (3,000/Reel)

(\*) The "-G" suffix denotes Halogen and Antimony free as well as being fully EU RoHS compliant.

DESIGNATOR : Output Voltage

	VR1(V)	VR2(V)		VR1(V)	VR2(V)
01	1.20	1.20	34	2.80	3.00
02	1.20	1.50	35	2.80	3.30
03	1.20	2.50	36	1.20	3.60
04	1.20	2.85	37	3.60	1.20
05	1.20	3.00	38	1.20	2.80
06	1.20	3.30	39	3.30	2.00
07	1.50	1.50	40	3.00	3.30
08	1.50	1.80	41	3.30	3.30
09	1.50	2.50	42	1.30	1.50
10	1.50	2.85	43	2.60	2.80
11	1.50	3.00	44	3.10	3.30
12	1.50	3.30	45	1.50	2.60
13	1.80	1.80	46	2.60	3.30
14	1.80	2.50	47	3.40	3.40
15	2.85	2.85	48	2.85	2.60
16	1.80	2.85	49	3.30	1.80
17	1.80	3.00	50	1.80	1.20
18	3.00	1.80	51	3.10	3.10
19	1.80	3.30	52	1.50	3.10
20	2.50	2.50	53	3.30	2.80
21	2.50	2.80	54	3.00	2.80
22	2.50	2.85	55	3.30	3.00
23	3.30	1.50	56	3.60	3.60
24	2.50	3.00	57	3.30	3.10
25	2.50	3.30	58	3.10	3.00
26	2.85	3.00	59	3.10	2.90
27	2.85	3.30	60	3.10	2.50
28	3.00	3.00	61	3.00	2.90
29	1.20	1.80	62	3.00	2.50
30	1.30	2.80	63	1.80	1.90
31	1.50	2.80	64	1.80	1.85
32	1.80	2.80	65	1.70	1.70
33	2.80	2.80			

\*For other output voltage combinations, please contact your local Torex sales office or representative.

## BLOCK DIAGRAM

### XC6421ABxxxxseries

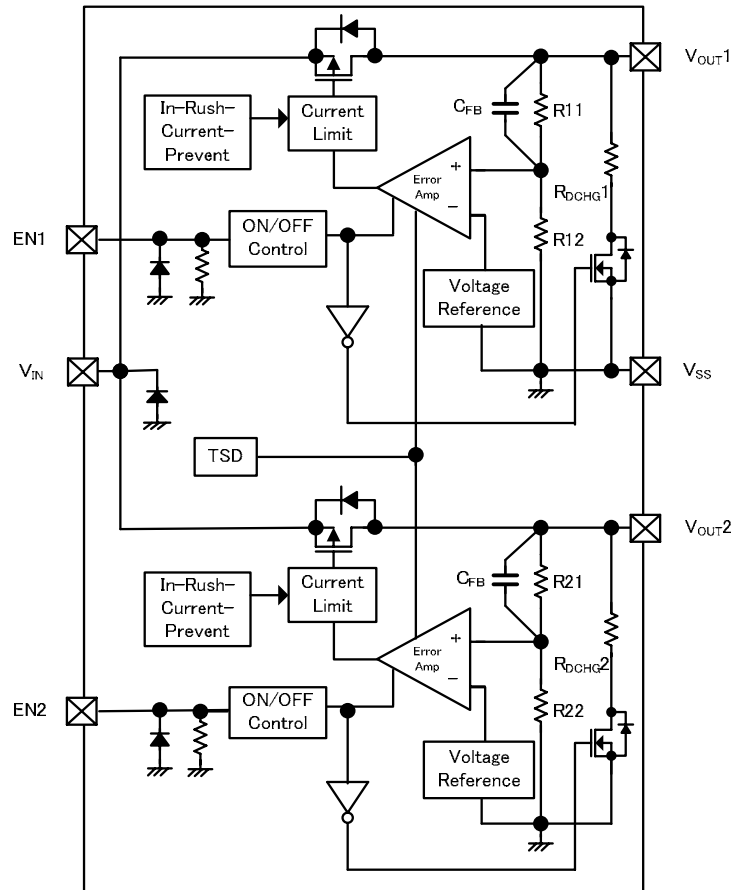

\* Diodes inside the circuits are ESD protection diodes and parasitic diodes.

## ABSOLUTE MAXIMUM RATINGS

PARAMETER		SYMBOL	RATINGS	UNITS
Input Voltage		$V_{IN}$	$V_{SS}-0.3 \sim V_{SS} +7.0$	V
Output Current		$I_{OUT1}+I_{OUT2}$	800 <sup>(*)</sup>	mA
Output Voltage 1, Output Voltage2		$V_{OUT1}, V_{OUT2}$	$V_{SS}-0.3 \sim V_{IN}+0.3$ $V_{SS} +7.0$	V
EN1, EN2 Input Voltage		$V_{EN1}, V_{EN2}$	$V_{SS}-0.3 \sim V_{SS} +7.0$	V
Power Dissipation	USP-6C	Pd	120	mW
			1000 (PCB mounted) <sup>(**)</sup>	
Operating Ambient Temperature		$T_{opr}$	-40 ~ +85	
Storage Temperature		$T_{stg}$	-55 ~ +125	

<sup>(\*)</sup>  $P_d > \{ (V_{IN}-V_{OUT1}) \times I_{OUT1} + (V_{IN}-V_{OUT2}) \times I_{OUT2} \}$

<sup>(\*\*)</sup> The power dissipation figure shown is PCB mounted. Please refer to page 23 for details.

# ELECTRICAL CHARACTERISTICS

## XC6421 Series

Ta=25

### Regulator 1, Regulator 2

PARAMETER	SYMBOL	CONDITIONS	MIN.	TYP.	MAX.	UNITS	CIRCUITS
Output Voltage	V <sub>OUT(E)</sub> <sup>(2)</sup>	V <sub>OUT</sub> = 2.0V, V <sub>EN</sub> =V <sub>IN</sub> , I <sub>OUT</sub> =10mA	V <sub>OUT(T)</sub> ×0.99 <sup>(2)</sup>	V <sub>OUT(T)</sub> <sup>(3)</sup>	V <sub>OUT(T)</sub> ×1.01 <sup>(2)</sup>	V	
		V <sub>OUT</sub> < 2.0V, V <sub>EN</sub> =V <sub>IN</sub> , I <sub>OUT</sub> =10mA	V <sub>OUT(T)</sub> - 20mV <sup>(2)</sup>	V <sub>OUT(T)</sub> <sup>(3)</sup>	V <sub>OUT(T)</sub> +20mV <sup>(2)</sup>	V	
Maximum Output Current	I <sub>OUTMAX</sub>	V <sub>EN</sub> =V <sub>IN</sub>	300	-	-	mA	
Load Regulation	ΔV <sub>OUT</sub>	V <sub>EN</sub> =V <sub>IN</sub> , I <sub>OUT</sub> = 300mA	-	25	45	mV	
Dropout Voltage <sup>(4)</sup>	V <sub>dif</sub>	I <sub>OUT</sub> =300mA, V <sub>EN</sub> =V <sub>IN</sub>	See the chart below			mV	
Supply Current	I <sub>SS</sub>	V <sub>EN</sub> =V <sub>IN</sub> , I <sub>OUT</sub> =0mA	-	90	190	μA	
Stand-by Current	I <sub>STB</sub>	V <sub>EN</sub> =V <sub>SS</sub>	-	0.01	0.1	μA	
Line Regulation	ΔV <sub>OUT</sub> / (ΔV <sub>IN</sub> ·V <sub>OUT</sub> )	2.5V V <sub>IN</sub> 5.5V, (V <sub>OUT(T)</sub> 2.0V), V <sub>EN</sub> =V <sub>IN</sub> , I <sub>OUT</sub> =30mA	-	0.02	0.1	%V	
		V <sub>OUT(T)</sub> +0.5V V <sub>IN</sub> 5.5V, (V <sub>OUT(T)</sub> 2.05V), V <sub>EN</sub> =V <sub>IN</sub> , I <sub>OUT</sub> =30mA					
Input Voltage	V <sub>IN</sub>	-	1.6	-	5.5	V	
Output Voltage Temperature Characteristics (R&D Value)	ΔV <sub>OUT</sub> / (ΔTa·V <sub>OUT</sub> )	V <sub>EN</sub> =V <sub>IN</sub> , I <sub>OUT</sub> =10mA, -40 Ta 85	-	±100	-	ppm /	
Power Supply Rejection Ratio	PSRR	V <sub>EN</sub> =V <sub>IN</sub> , V <sub>IN</sub> ={V <sub>OUT(T)</sub> +1.0}+0.5Vp-pAC I <sub>OUT</sub> =30mA, f=1kHz	-	75	-	dB	
Limit Current	I <sub>LIM</sub>	V <sub>EN</sub> =V <sub>IN</sub>	310	450	-	mA	
Short-Circuit Current	I <sub>SHORT</sub>	V <sub>EN</sub> =V <sub>IN</sub> , V <sub>OUT</sub> =V <sub>SS</sub>	-	125	-	mA	
EN"H"Level Voltage	V <sub>ENH</sub>	-	1.0	-	5.5	V	
EN"L"Level Voltage	V <sub>ENL</sub>	-	0	-	0.3	V	
EN"H"Level Current	I <sub>ENH</sub>	V <sub>EN</sub> =V <sub>IN</sub> =5.5V	2.9	6.0	9.5	μA	
EN"L"Level Current	I <sub>ENL</sub>	V <sub>EN</sub> =V <sub>SS</sub>	-0.1	-	0.1	μA	
C <sub>L</sub> Discharge Resistance	R <sub>DCHG</sub>	V <sub>IN</sub> =5.5V, V <sub>EN</sub> =V <sub>SS</sub> , V <sub>OUT</sub> =2.0V	-	230	-	Ω	
Inrush Current	I <sub>RUSH</sub>	-	-	150	-	mA	
Thermal Shutdown Detect Temperature	T <sub>TSD</sub>	Junction Temperature	-	150	-		
Thermal Shutdown Release Temperature	T <sub>TSR</sub>	Junction Temperature	-	125	-		
Thermal Shutdown Release Temperature	T <sub>TSD</sub> - T <sub>TSR</sub>	Junction Temperature	-	25	-		

**NOTE:**

Unless otherwise stated, {V<sub>IN</sub>=V<sub>OUT(T)</sub>+1.0V}

Each channel is measured when the other channel is turned off (V<sub>EN</sub>=V<sub>SS</sub>).

(\*1) V<sub>OUT(E)</sub>: Effective output voltage (see the voltage chart)

(ie. The output voltage when "V<sub>OUT(T)</sub>+1.0V" is provided at the V<sub>IN</sub> pin while maintaining a certain I<sub>OUT</sub> value.

(\*2) Characteristics of the actual V<sub>OUT(E)</sub> by nominal output voltage is shown in the voltage chart.

(\*3) V<sub>OUT(T)</sub>: Nominal output voltage

(\*4) V<sub>dif</sub> = {V<sub>IN1</sub> - V<sub>OUT1</sub>}

V<sub>OUT1</sub>: A voltage equal to 98% of the output voltage whenever an amply stabilized {V<sub>OUT(T)</sub>+1.0V} is input with every I<sub>OUT</sub>.

V<sub>IN1</sub>: The input voltage when V<sub>OUT1</sub> appears as input voltage is gradually decreased.

## OUTPUT VOLTAGE CHART

Regulator 1, Regulator 2  
Voltage chart

Ta=25

NOMINAL OUTPUT VOLTAGE (V)	OUTPUT VOLTAGE (V)		DROPOUT VOLTAGE (mV)	
	V <sub>OUT(E)</sub>		V <sub>dif</sub>	
	MIN.	MAX.	TYP.	MAX.
1.200	1.1800	1.2200	580	680
1.250	1.2300	1.2700		
1.300	1.2800	1.3200	515	610
1.350	1.3300	1.3700		
1.400	1.3800	1.4200	460	550
1.450	1.4300	1.4700		
1.500	1.4800	1.5200		
1.550	1.5300	1.5700		
1.600	1.5800	1.6200	380	450
1.650	1.6300	1.6700		
1.700	1.6800	1.7200		
1.750	1.7300	1.7700		
1.800	1.7800	1.8200	330	390
1.850	1.8300	1.8700		
1.900	1.8800	1.9200		
1.950	1.9300	1.9700		
2.000	1.9800	2.0200	295	350
2.050	2.0295	2.0705		
2.100	2.0790	2.1210		
2.150	2.1285	2.1715		
2.200	2.1780	2.2220		
2.250	2.2275	2.2725		
2.300	2.2770	2.3230		
2.350	2.3265	2.3735		
2.400	2.3760	2.4240		
2.450	2.4255	2.4745		

NOMINAL OUTPUT VOLTAGE (V)	OUTPUT VOLTAGE (V)		DROPOUT VOLTAGE (mV)	
	V <sub>OUT(E)</sub>		V <sub>dif</sub>	
	MIN.	MAX.	TYP.	MAX.
2.500	2.4750	2.5250	240	290
2.550	2.5245	2.5755		
2.600	2.5740	2.6260		
2.650	2.6235	2.6765		
2.700	2.6730	2.7270		
2.750	2.7225	2.7775		
2.800	2.7720	2.8280		
2.850	2.8215	2.8785		
2.900	2.8710	2.9290		
2.950	2.9205	2.9795		
3.000	2.9700	3.0300	210	260
3.050	3.0195	3.0805		
3.100	3.0690	3.1310		
3.150	3.1185	3.1815		
3.200	3.1680	3.2320		
3.250	3.2175	3.2825		
3.300	3.2670	3.3330		
3.350	3.3165	3.3835		
3.400	3.3660	3.4340		
3.450	3.4155	3.4845		
3.500	3.4650	3.5350		
3.550	3.5145	3.5855		
3.600	3.5640	3.6360		

## OPERATIONAL EXPLANATION

The voltage divided by resistors Rx1 & Rx2 is compared with the internal reference voltage by the error amplifier. The P-channel MOSFET which is connected to the Output pin ( $V_{OUT}$ ) is then driven by the subsequent control signal. The output voltage at the Output pin ( $V_{OUT}$ ) is controlled and stabilized by a system of negative feedback. The current limit circuit, short circuit protection and thermal protection operate in relation to the level of output current and heat dissipation. Further, the IC's internal circuitry can be shutdown via the EN pin signal.

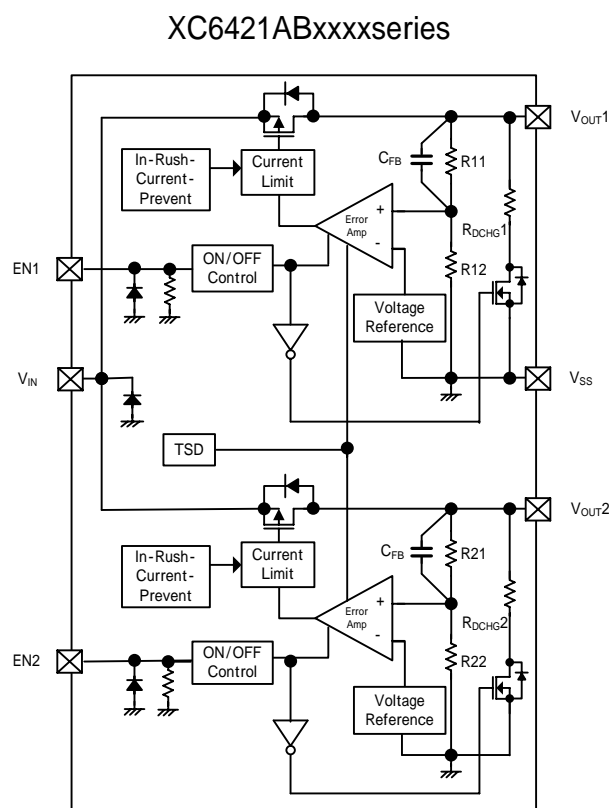

### <Low ESR Capacitor>

The XC6421 series needs an output capacitor ( $C_L$ ) for phase compensation. In order to ensure the stable phase compensation, please place an output capacitor ( $C_L$ ) of 1.0  $\mu$ F or bigger at the  $V_{OUT}$  pin and  $V_{SS}$  pin as close as possible. For a stable power input, please connect an input capacitor ( $C_{IN}$ ) of 1.0  $\mu$ F between  $V_{IN}$  pin and  $V_{SS}$  pin.

### <Current Limiter, Short-Circuit Protection>

The XC6421 series has current limiter and droop shape of fold-back circuit. When the load current reaches the current limit, the droop current limiter circuit operates and the output voltage drops. When the output voltage dropped, the fold-back circuit operates and the output current goes to decrease. The output current finally falls at the level of 125mA when the output pin is short-circuited.

### <EN Pin>

The IC's internal circuitry can be shutdown via the signal from the EN pin. In shutdown mode, the XC6421 series enables the electric charge at the output capacitor ( $C_L$ ) to be discharged via the internal auto-discharge switch, and as a result the output pin ( $V_{OUT}$ ) quickly returns to the ground pin ( $V_{SS}$ ) level.

On the other hand, the XC6421 series has a pull-down resistor at the EN pin inside, so that the EN pin input current flows. If this EN pin voltage is set with the specified voltage range, the logic is fixed and the IC will operate normally. However, the supply current may increase as a result of shoot-through current in the IC's internal circuitry when a medium voltage is input to the EN pin.

## OPERATIONAL EXPLANATION (Continued)

### <C<sub>L</sub> Auto-Discharge Function>

XC6421 series can quickly discharge the electric charge at the output capacitor (C<sub>L</sub>), when a low signal is inputted to the EN pin, which enables a part of the IC circuit put into OFF state, via the N-channel transistor located between the V<sub>OUT</sub> pin and the V<sub>SS</sub> pin (cf. BLOCK DIAGRAM). The C<sub>L</sub> discharge resistance is set to 230 Ω when V<sub>IN</sub> is 5.5V (TYP.) and V<sub>OUT</sub> is 2.0V (TYP.). Moreover, discharge time of the output capacitor (C<sub>L</sub>) is set by the C<sub>L</sub> auto-discharge resistance and the output capacitance (C<sub>L</sub>). By setting time constant of a C<sub>L</sub> auto-discharge resistance [R<sub>DCHG</sub>] and an output capacitance (C<sub>L</sub>) as  $\tau = C_L \times R_{DCHG}$ , the output voltage after discharge via the N channel transistor is calculated by the following formulas.

$$V = V_{OUT(E)} \times e^{-t/\tau}, \text{ or } t = \tau \ln ( V_{OUT(E)} / V )$$

V : Output voltage after discharge

V<sub>OUT(E)</sub> : Output voltage

t: Discharge time,

$\tau = R_{DCHG} \times C_L$

C<sub>L</sub>: Output capacitance

R<sub>DCHG</sub>: C<sub>L</sub> auto-discharge resistance

### <Thermal Shutdown>

When the junction temperature of the built-in driver transistor reaches the temperature limit, the thermal shutdown circuit operates and the driver transistor will be set to OFF. The IC resumes its operation when the thermal shutdown function is released and the IC's operation is automatically restored because the junction temperature drops to the level of the thermal shutdown release voltage.

### <Inrush Current Protection>

The inrush current protection circuit is built in the XC6421 series.

When the IC starts to operate, the protection circuit limits the inrush current as 150mA (TYP.) from input pin (V<sub>IN</sub>) to output pin (V<sub>OUT</sub>) for charging C<sub>L</sub> capacitor.



## NOTES ON USE

1. For temporary, transitional voltage drop or voltage rising phenomenon, the IC is liable to malfunction should the ratings be exceeded.
2. Where wiring impedance is high, operations may become unstable due to the noise and/or phase lag depending on output current. Please strengthen  $V_{IN}$  and  $V_{SS}$  wiring in particular.
3. Please wire the input capacitor ( $C_{IN}$ ) and the output capacitor ( $C_L$ ) as close to the IC as possible.
4. Torex places an importance on improving our products and its reliability.  
However, by any possibility, we would request user fail-safe design and post-aging treatment on system or equipment.

## TEST CIRCUITS

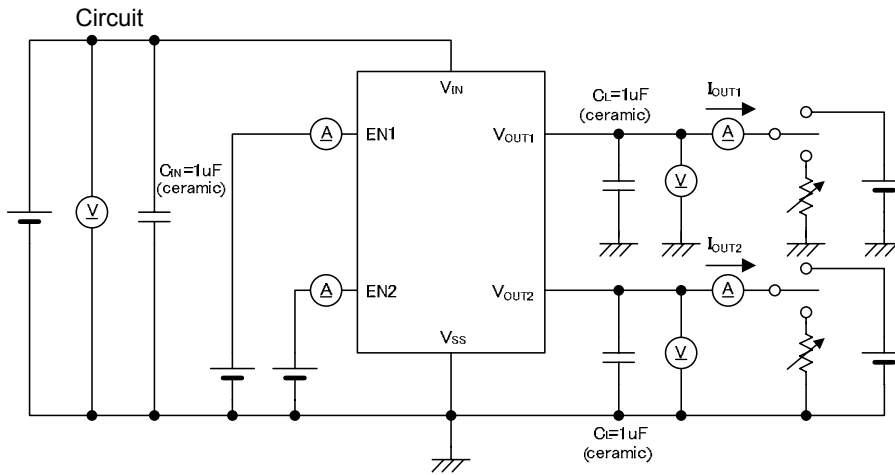

Circuit

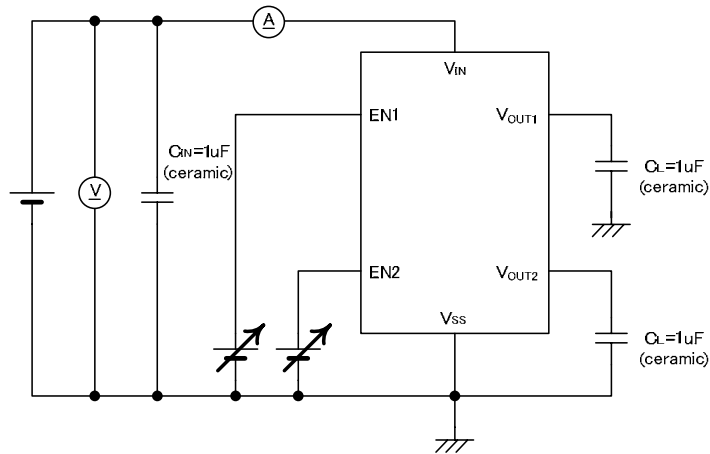

Circuit

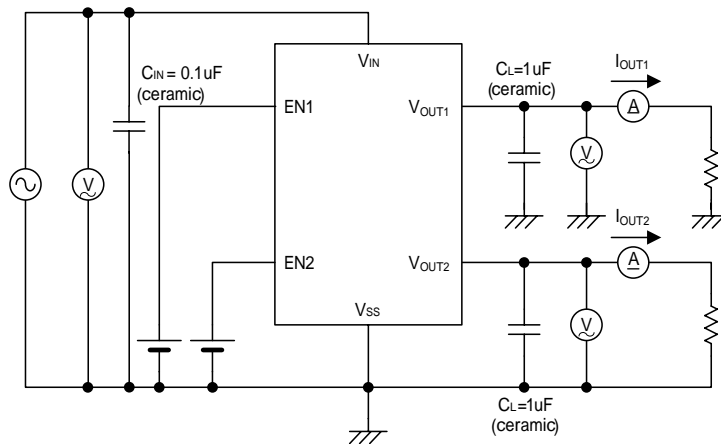

# TYPICAL PERFORMANCE CHARACTERISTICS

## (1) OutputVoltage vs. OutputCurrent

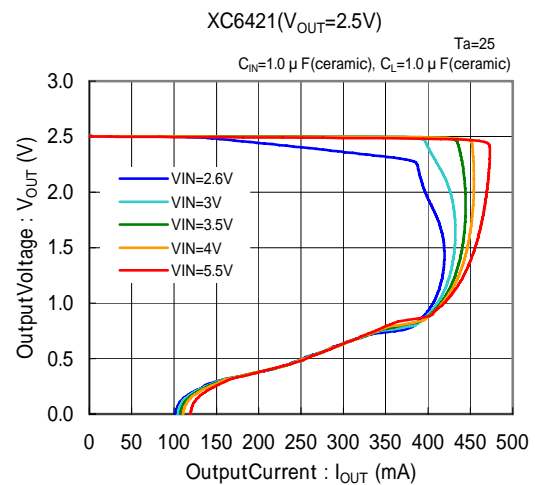
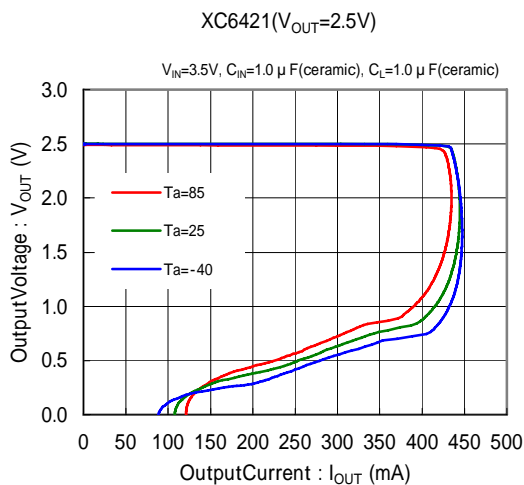
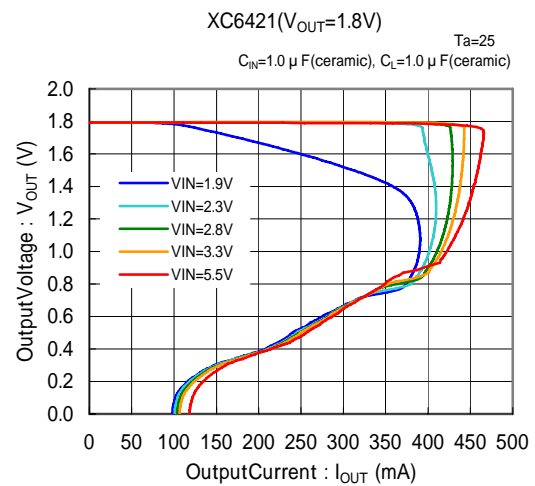
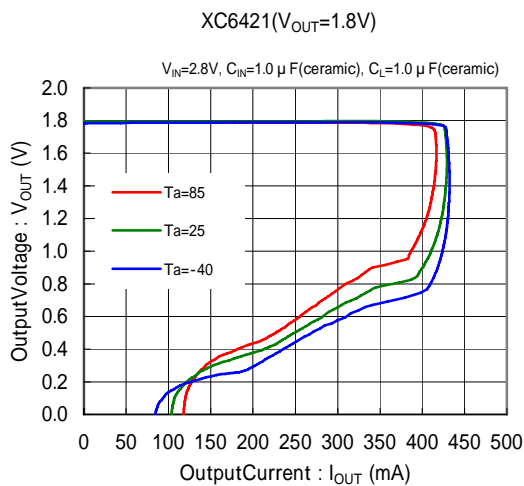
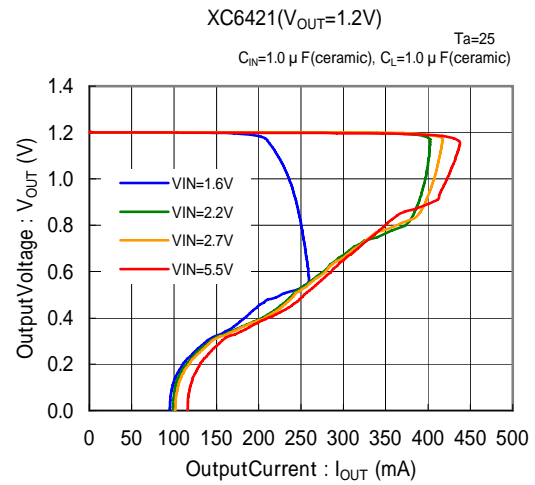
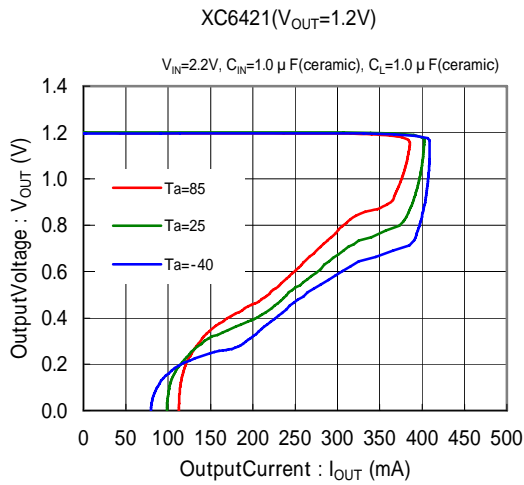

## TYPICAL PERFORMANCE CHARACTERISTICS (Continued)

### (1) OutputVoltage vs. OutputCurrent

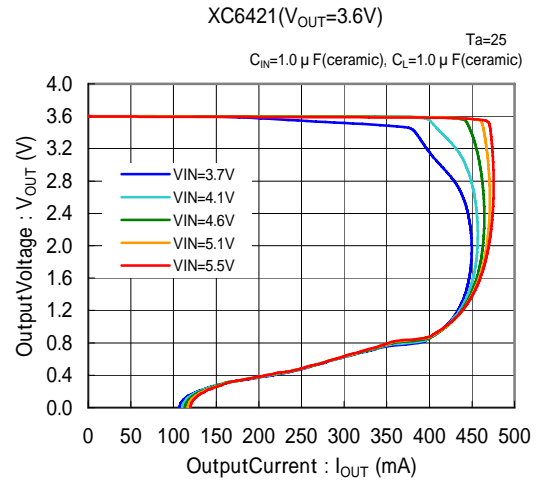
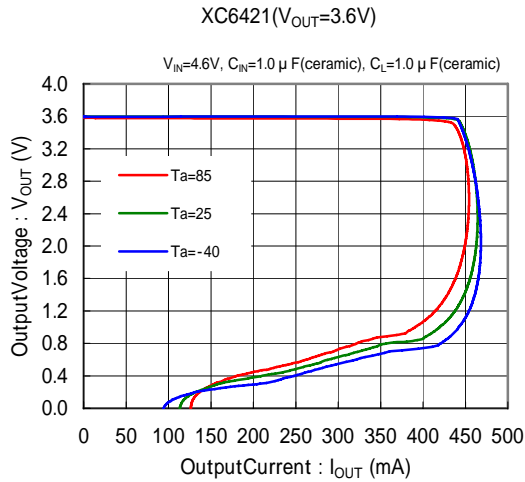

### (2) OutputVoltage vs. InputVoltage

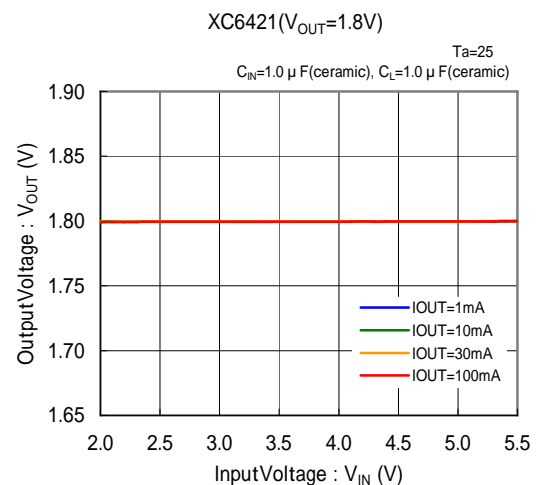
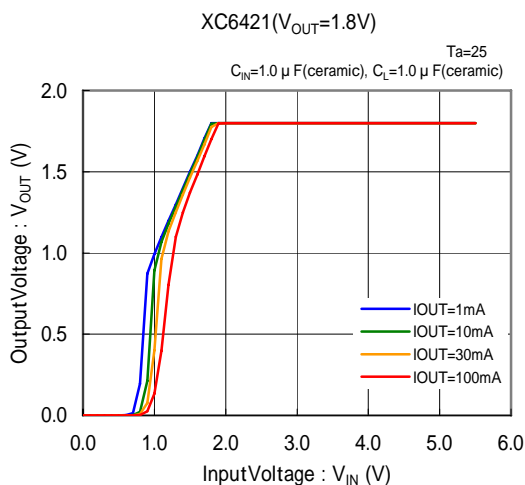
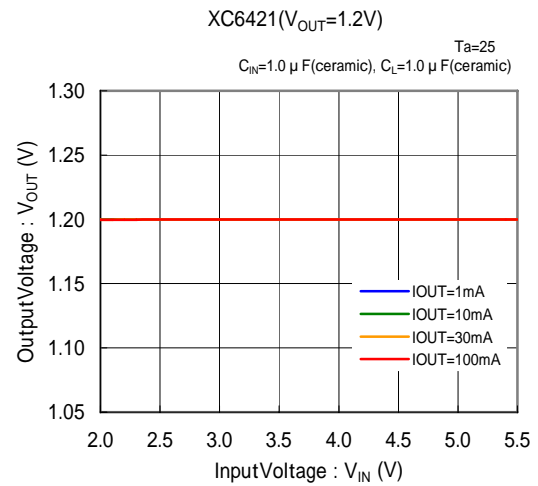
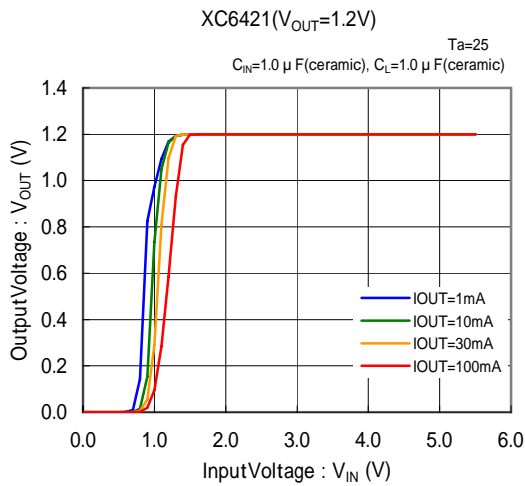

## TYPICAL PERFORMANCE CHARACTERISTICS (Continued)

### (2) Output Voltage vs. Input Voltage

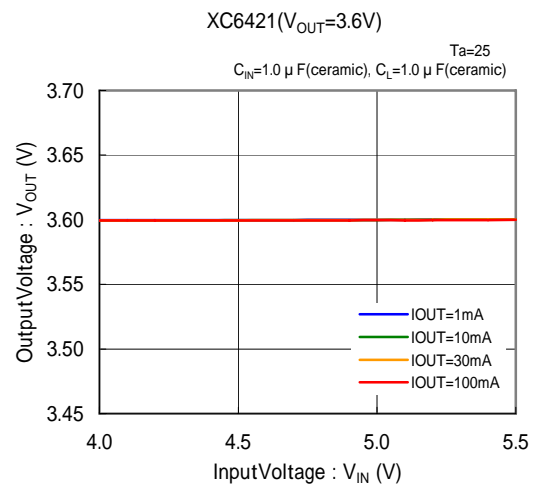
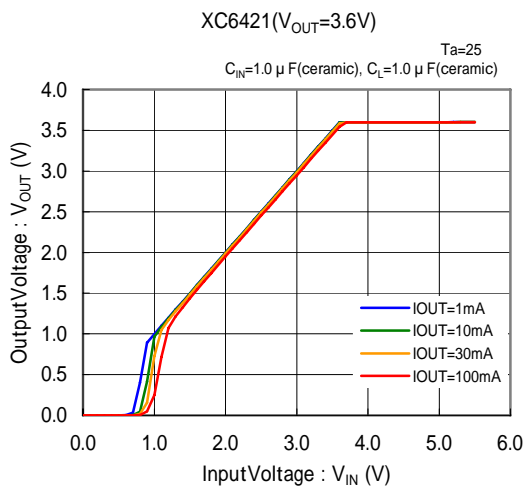
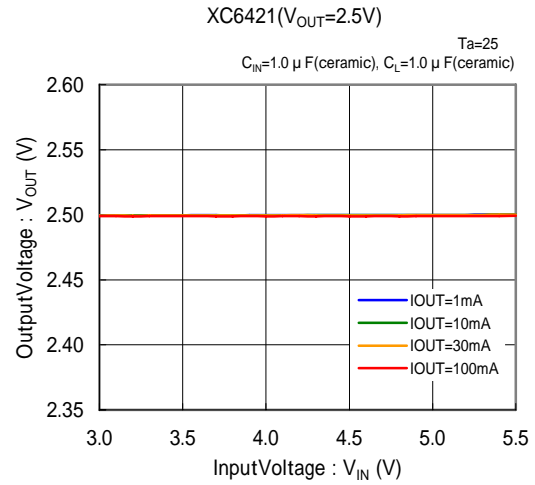
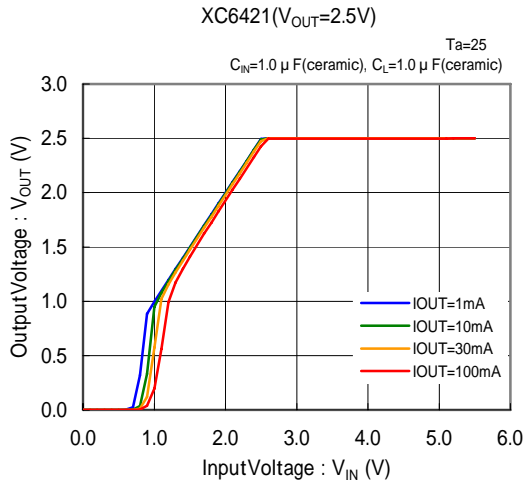

### (3) Dropout Voltage vs. Output Current

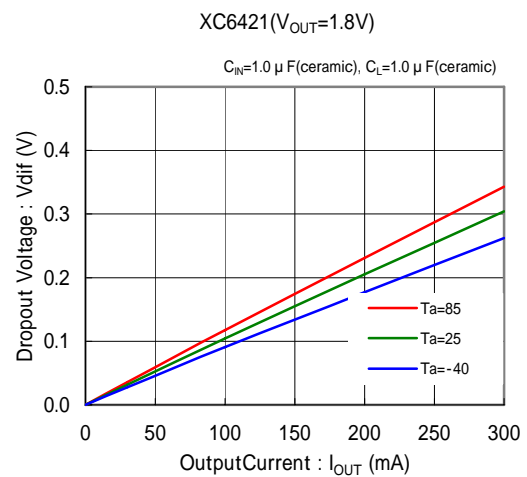
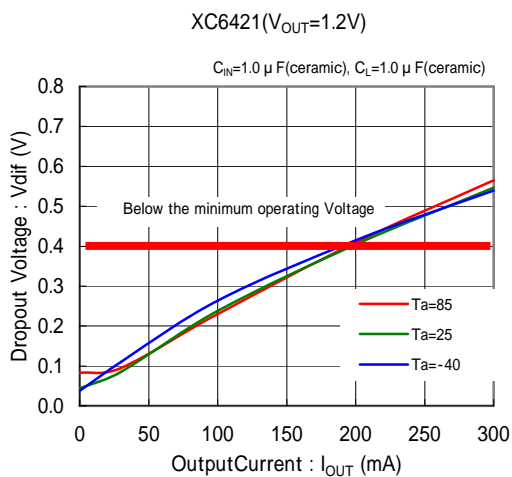

## TYPICAL PERFORMANCE CHARACTERISTICS (Continued)

### (3) Dropout Voltage vs. Output Current

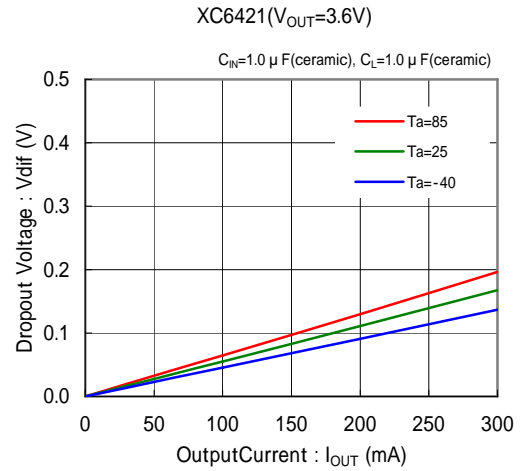
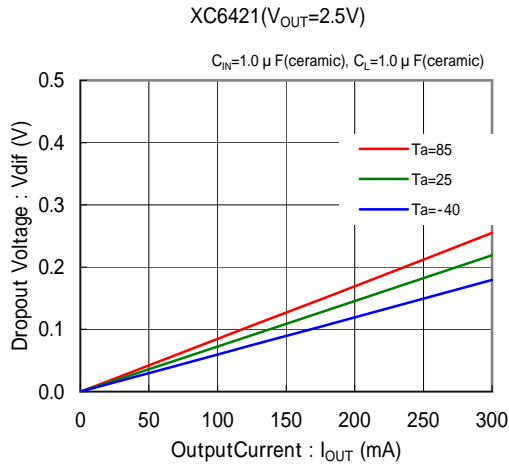

### (4) Supply Current vs. Input Voltage

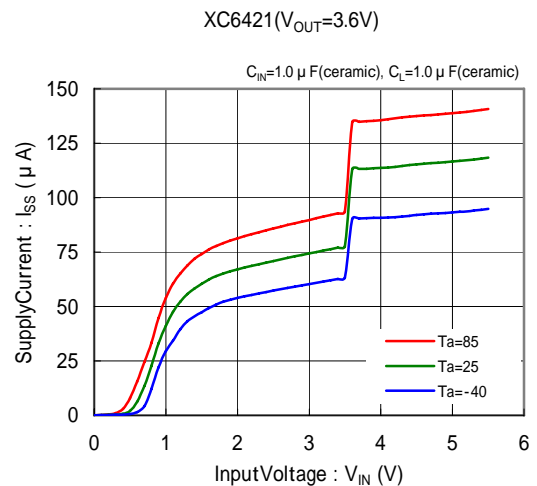
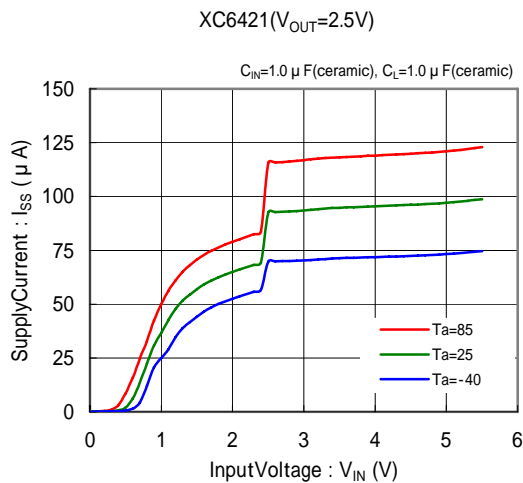
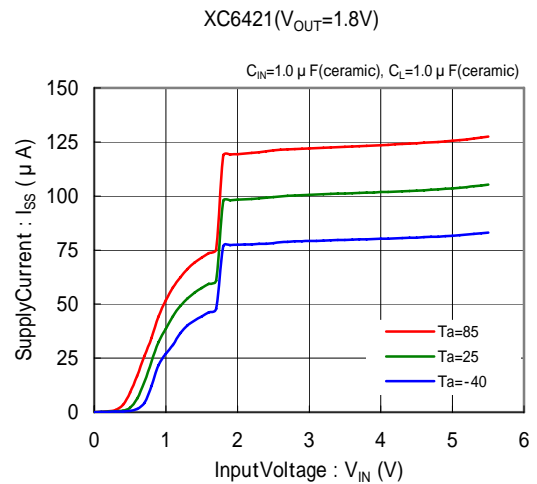
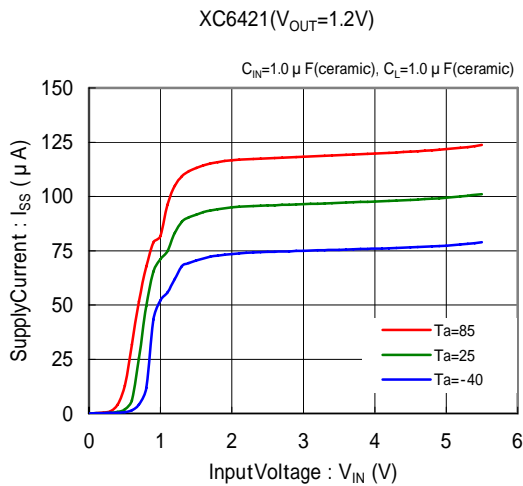

## TYPICAL PERFORMANCE CHARACTERISTICS (Continued)

(5) Output Voltage vs. Ambient Temperature

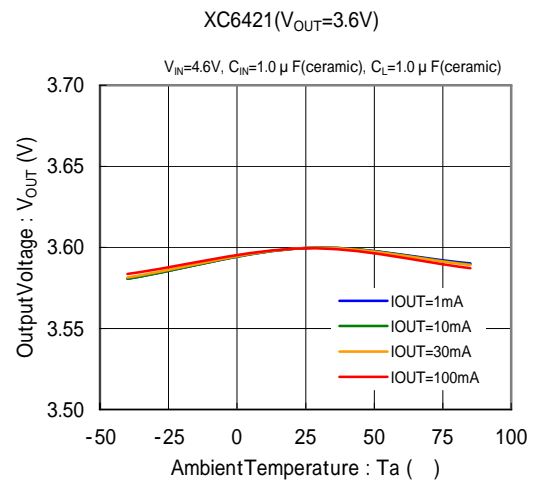
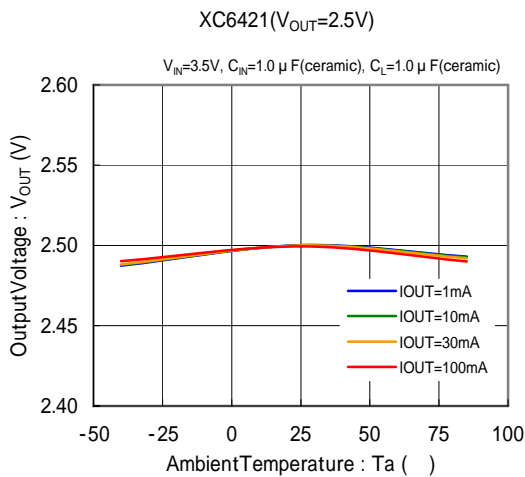
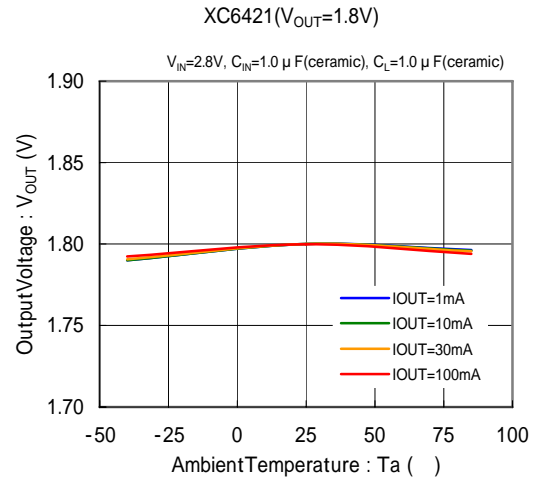
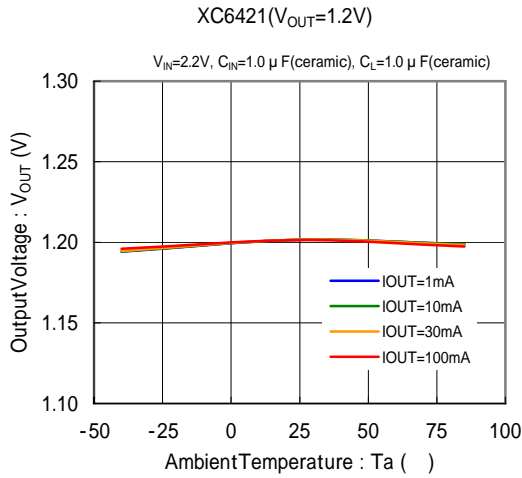

(6) Supply Current vs. Ambient Temperature

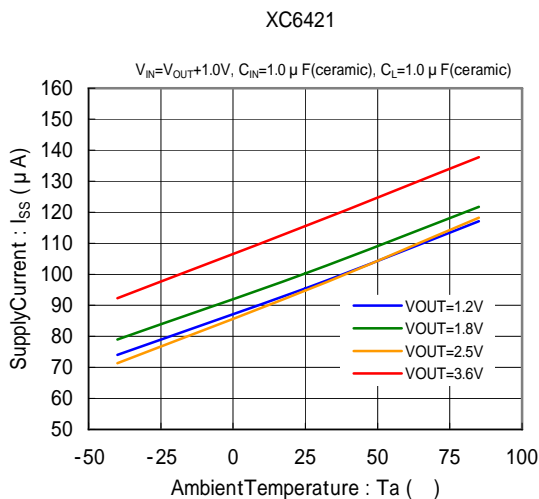

(7) EN Threshold Voltage vs. Ambient Temperature

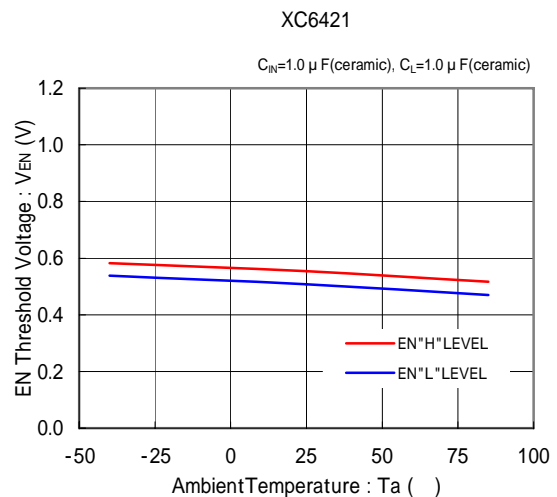

## TYPICAL PERFORMANCE CHARACTERISTICS (Continued)

### (8) Rising Response Time

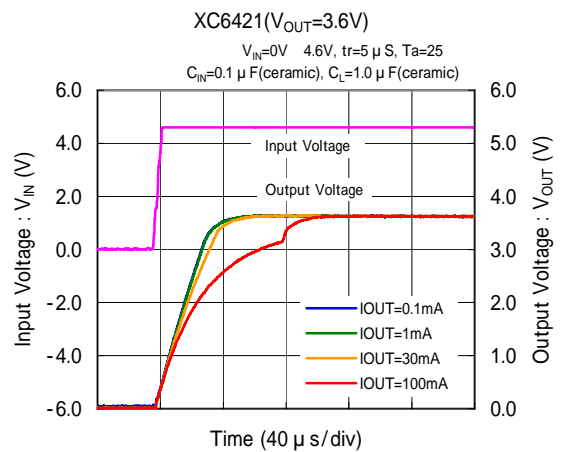
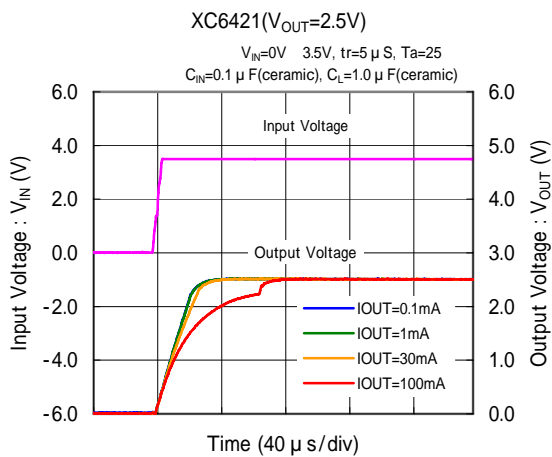
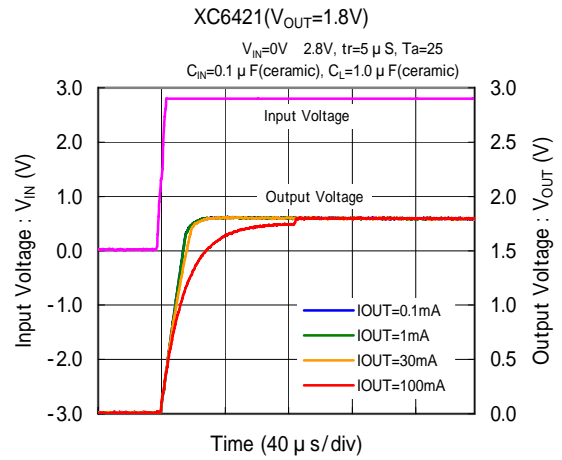
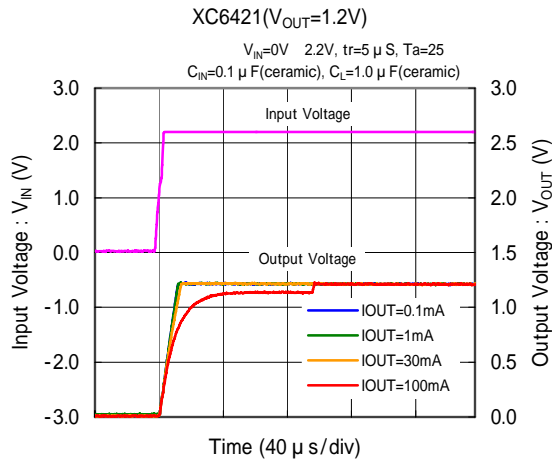

### (9) Input Transient Response

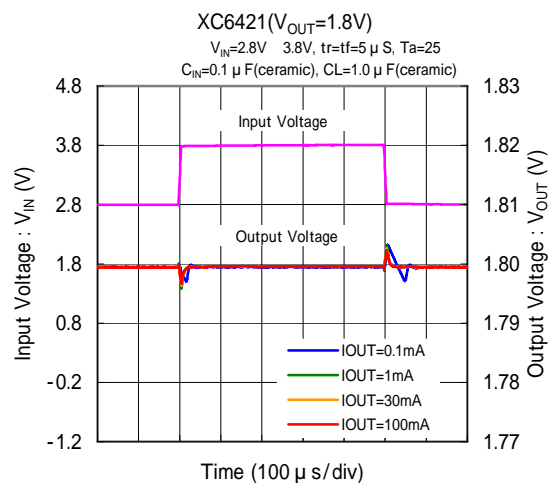
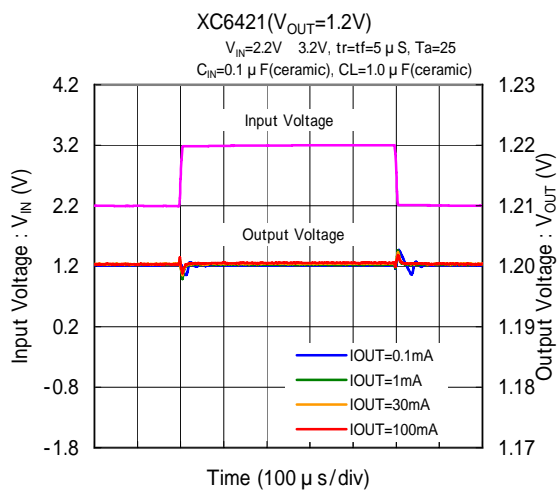



## TYPICAL PERFORMANCE CHARACTERISTICS (Continued)

### (9) Input Transient Response

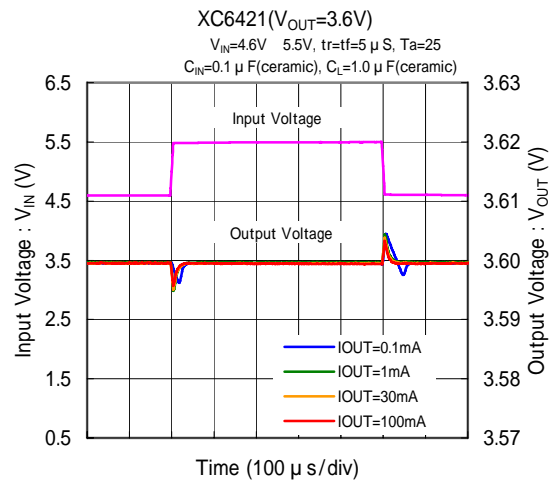
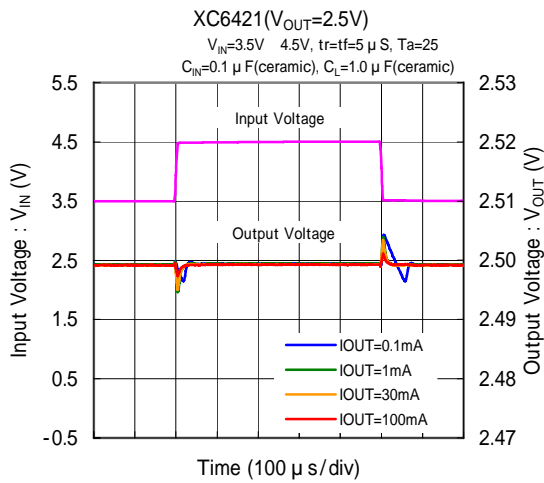

### (10) Load Transient Response

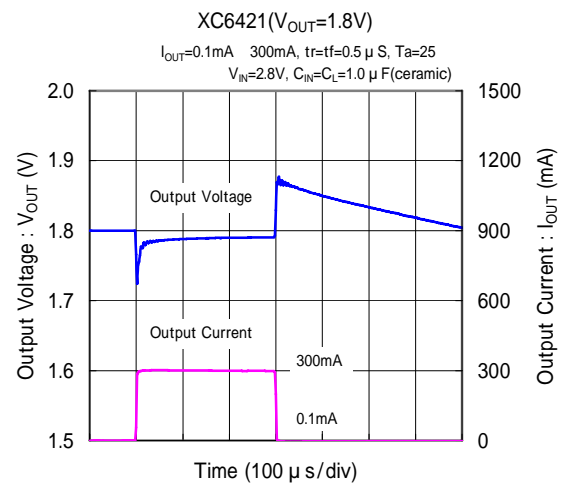
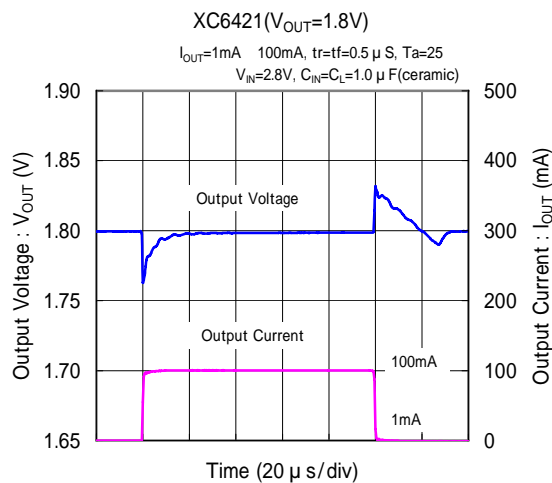
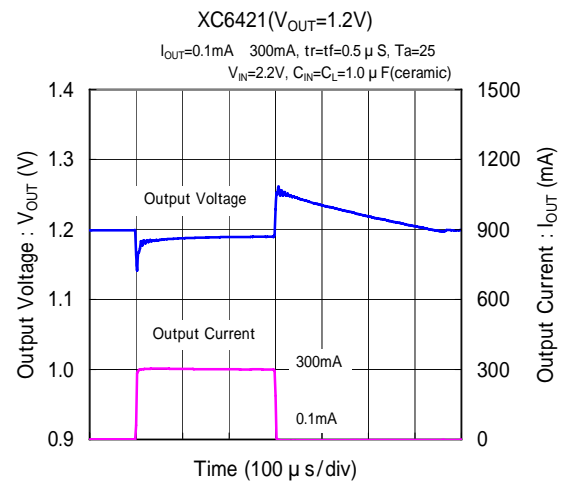
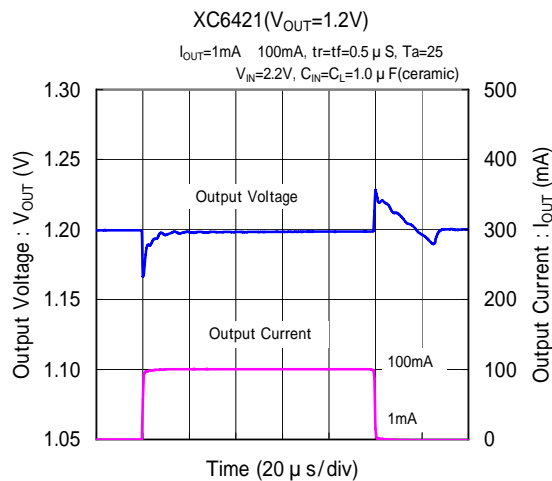

## TYPICAL PERFORMANCE CHARACTERISTICS (Continued)

### (10) Load Transient Response

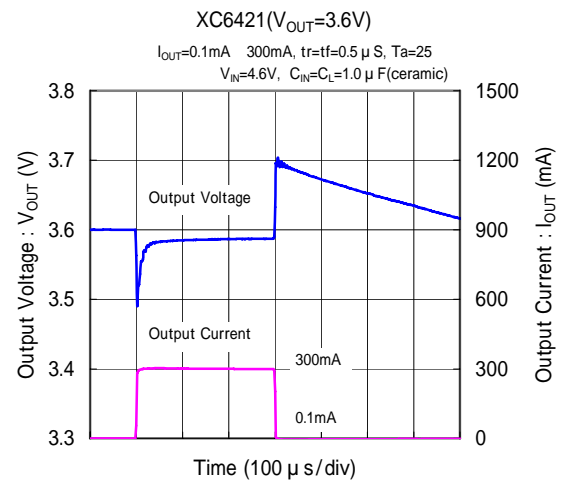
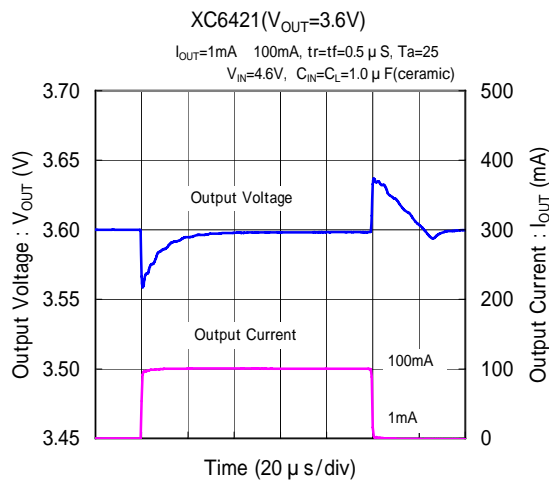
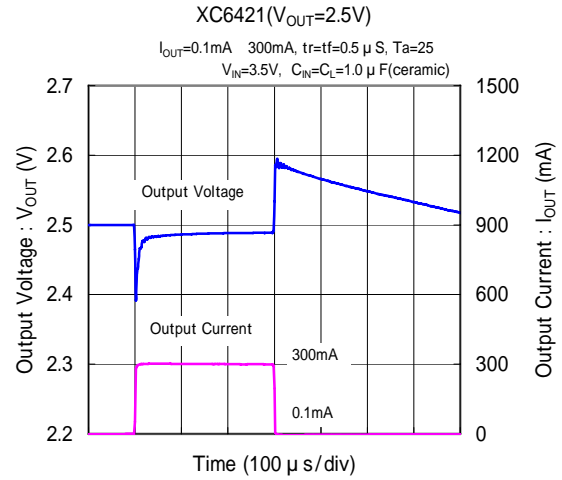
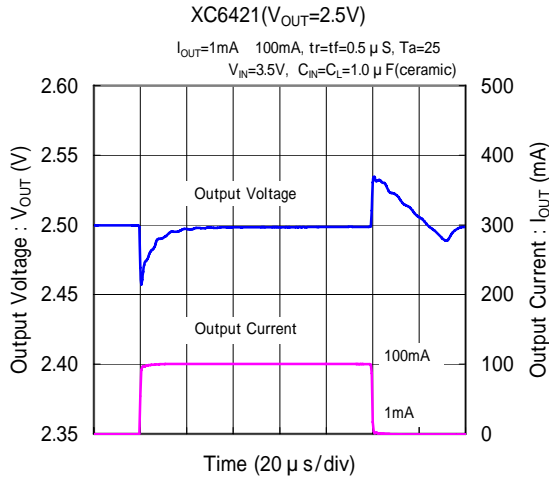

### (11) EN Rising Response Time

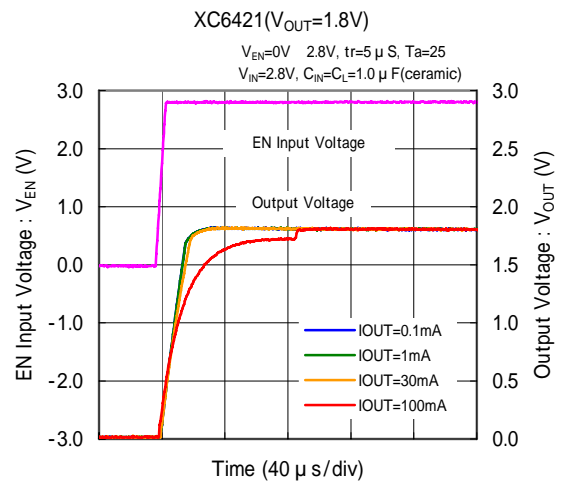
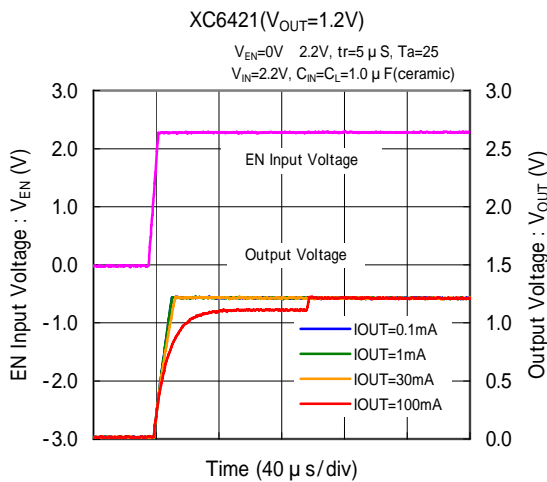

## TYPICAL PERFORMANCE CHARACTERISTICS (Continued)

### (11) EN Rising Response Time

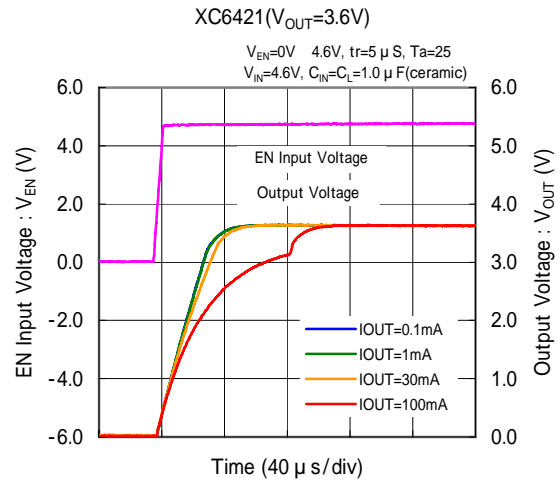
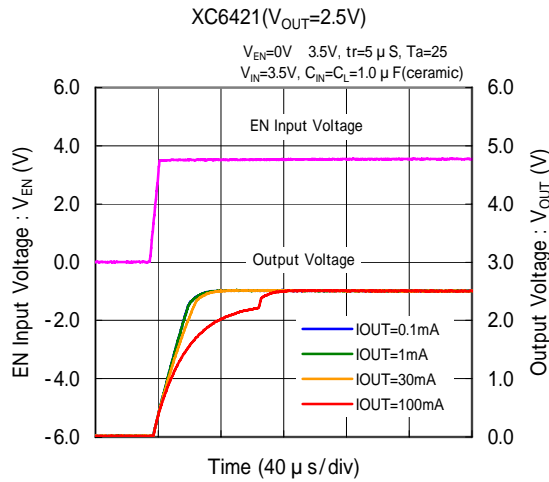

### (12) Ripple Rejection Rate

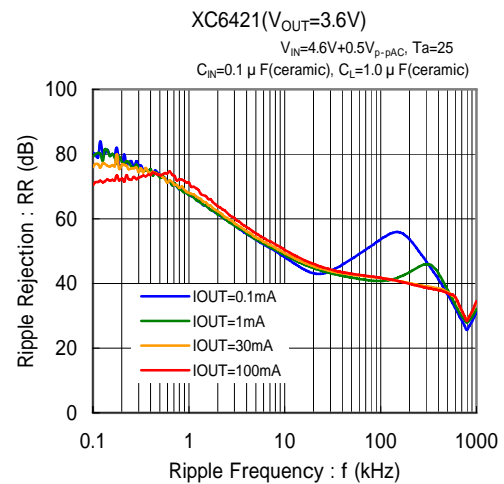
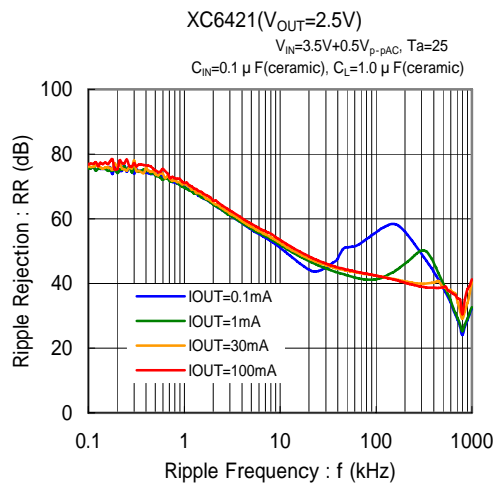
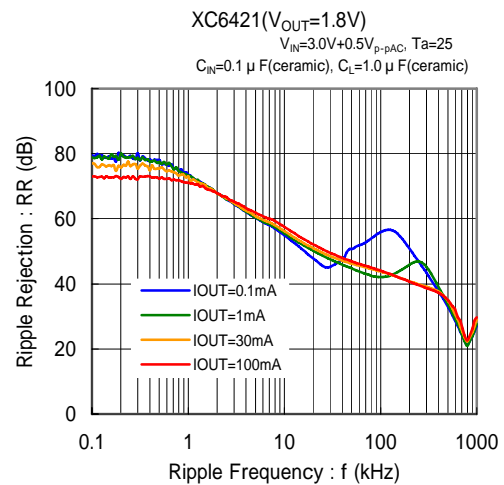
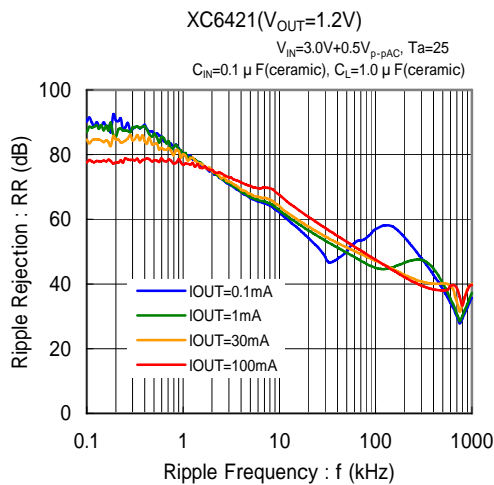

## TYPICAL PERFORMANCE CHARACTERISTICS (Continued)

### (13) Inrush Current Response

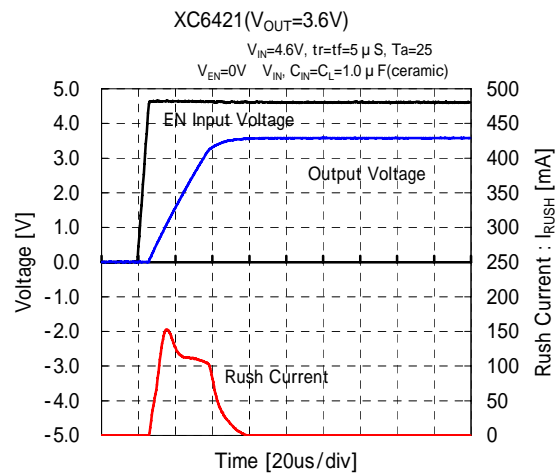
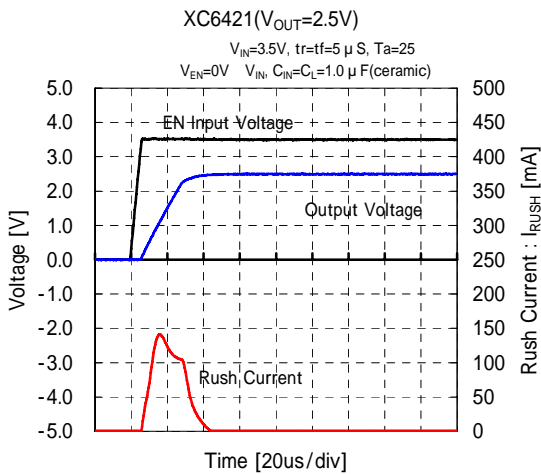
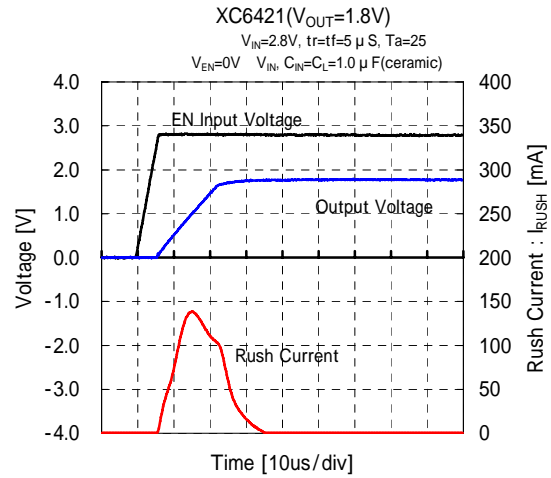
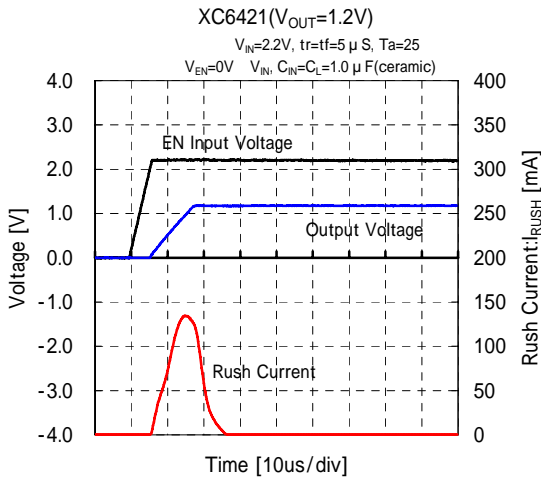

### (14) Cross Talk

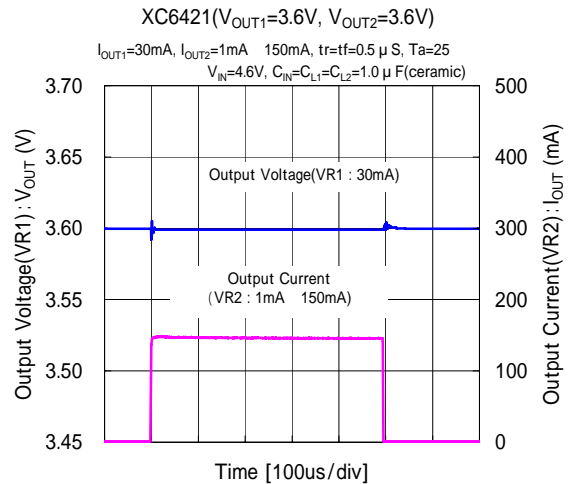
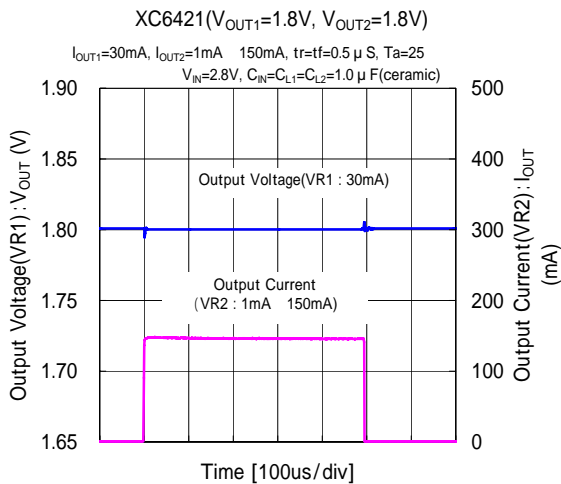

## TYPICAL PERFORMANCE CHARACTERISTICS (Continued)

### (15) Output Noise Density

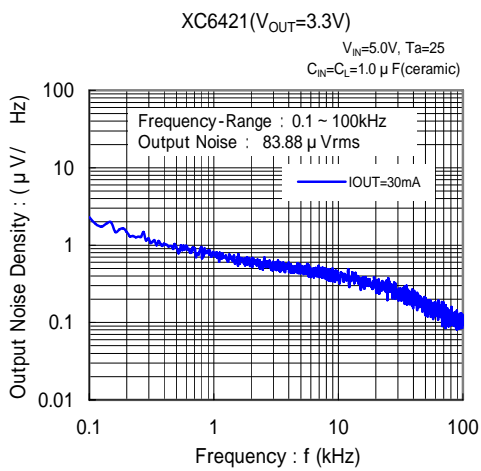
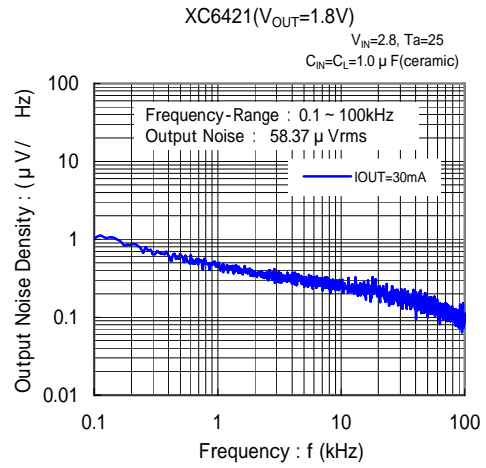
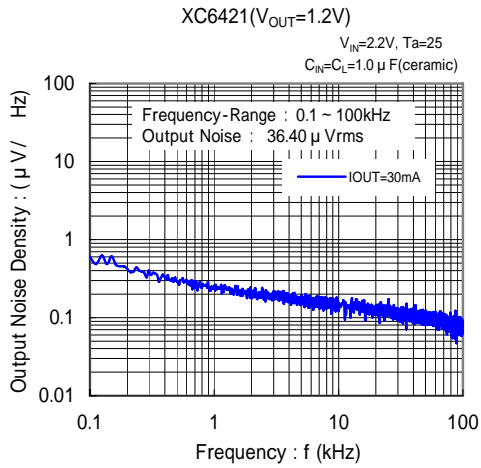

## PACKAGING INFORMATION

### USP-6C

(unit : mm)

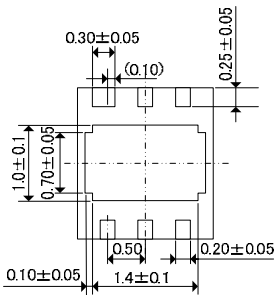
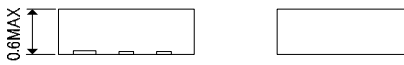
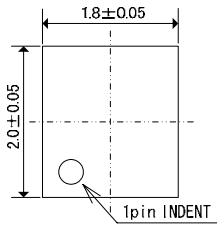

### USP-6C Reference Pattern Layout

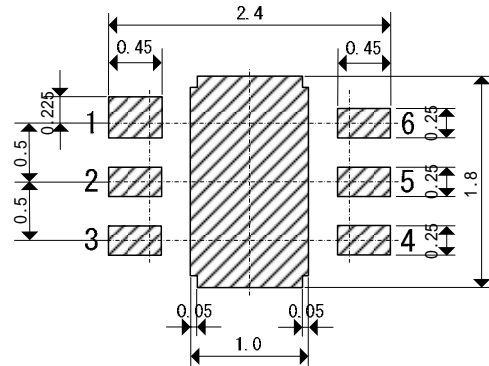

### USP-6C Reference Metal Mask Design

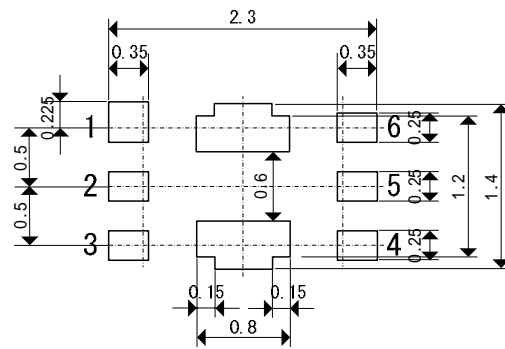

## PACKAGING INFORMATION (Continued)

### USP-6C Power Dissipation

Power dissipation data for the USP-6C is shown in this page.  
The value of power dissipation varies with the mount board conditions.  
Please use this data as the reference data taken in the following condition.

#### 1. Measurement Condition

- Condition: Mount on a board
- Ambient: Natural convection
- Soldering: Lead (Pb) free
- Board: Dimensions 40 x 40 mm (1600 mm<sup>2</sup> in one side)  
Copper (Cu) traces occupy 50% of the board area  
In top and back faces  
Package heat-sink is tied to the copper traces
- Material: Glass Epoxy (FR-4)
- Thickness: 1.6 mm
- Through-hole: 4 x 0.8 Diameter

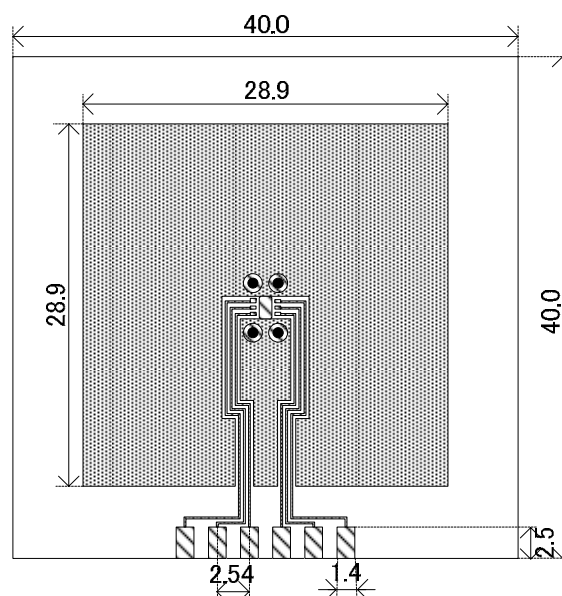

Evaluation Board (Unit: mm)

#### 2. Power Dissipation vs. Ambient Temperature

Board Mount ( $T_j \text{ max} = 125$  )

Ambient Temperature ( )	Power Dissipation Pd (mW)	Thermal Resistance ( /W)
25	1000	100.00
85	400	

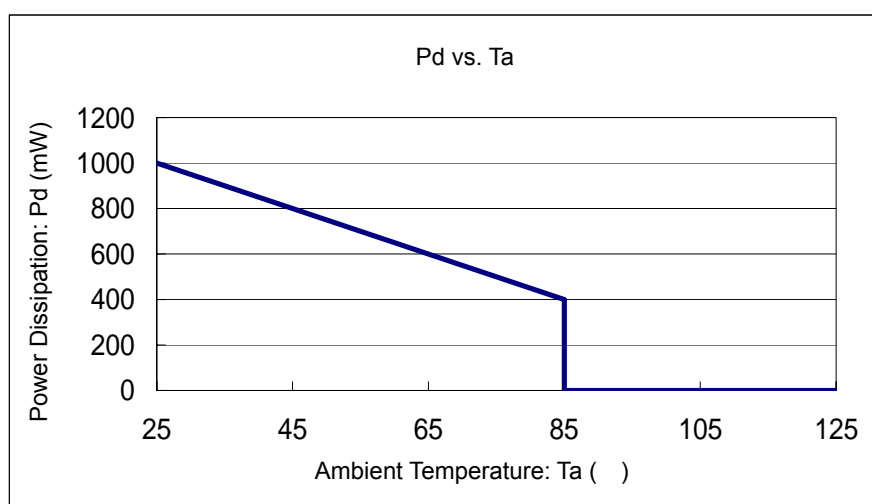

## MARKING RULE

USP-6C

represents product series

MARK	PRODUCT SERIES
R	XC6421*****-G

represents output voltage  
ex.)

MARK		PRODUCT SERIES
0	1	XC6421**01**-G

represents production lot number  
01 to 09, 0A to 0Z, 11 to 9Z, A1 to A9, AA to Z9, ZA to ZZ in order.  
(G, I, J, O, Q, W excluded. No character inversion used.)

USP-6C

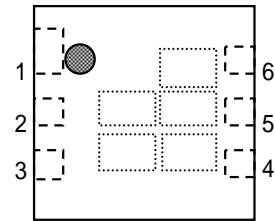



1. The products and product specifications contained herein are subject to change without notice to improve performance characteristics. Consult us, or our representatives before use, to confirm that the information in this datasheet is up to date.
2. We assume no responsibility for any infringement of patents, patent rights, or other rights arising from the use of any information and circuitry in this datasheet.
3. Please ensure suitable shipping controls (including fail-safe designs and aging protection) are in force for equipment employing products listed in this datasheet.
4. The products in this datasheet are not developed, designed, or approved for use with such equipment whose failure or malfunction can be reasonably expected to directly endanger the life of, or cause significant injury to, the user.  
(e.g. Atomic energy; aerospace; transport; combustion and associated safety equipment thereof.)
5. Please use the products listed in this datasheet within the specified ranges.  
Should you wish to use the products under conditions exceeding the specifications, please consult us or our representatives.
6. We assume no responsibility for damage or loss due to abnormal use.
7. All rights reserved. No part of this datasheet may be copied or reproduced without the prior permission of TOREX SEMICONDUCTOR LTD.

**TOREX SEMICONDUCTOR LTD.**

单击下面可查看定价，库存，交付和生命周期等信息

[>>Torex Semiconductor\(特瑞仕\)](#)