

**CoolMOS™ Power Transistor**
**Features**

- Lowest figure of merit  $R_{ON} \times Q_g$
- Ultra low gate charge
- Extreme dv/dt rated
- High peak current capability
- Pb-free lead plating; RoHS compliant; Halogen free for mold compound
- Qualified for industrial grade applications according to JEDEC<sup>1)</sup>

**Product Summary**

|                     |       |          |
|---------------------|-------|----------|
| $V_{DS} @ T_{jmax}$ | 550   | V        |
| $R_{DS(on),max}$    | 0.350 | $\Omega$ |
| $Q_{g,typ}$         | 19    | nC       |

**CoolMOS CP is specially designed for:**

- Hard and softswitching SMPS for server power supplies
- CCM PFC for Notebook adapter, PDP and LCD TV
- PWM for Notebook adapter, PDP and LCD TV

**PG-TO262**

| Type        | Package  | Marking |
|-------------|----------|---------|
| IPI50R350CP | PG-TO262 | 5R350P  |

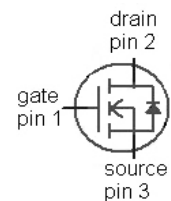
**Maximum ratings, at  $T_j=25\text{ °C}$ , unless otherwise specified**

| Parameter                                      | Symbol         | Conditions                                | Value       | Unit               |
|--|----------------|---|-------------|--------------------|
| Continuous drain current                       | $I_D$          | $T_C=25\text{ °C}$                        | 10          | A                  |
|  |                | $T_C=100\text{ °C}$                       | 6           |                    |
| Pulsed drain current <sup>2)</sup>             | $I_{D,pulse}$  | $T_C=25\text{ °C}$                        | 22          |                    |
| Avalanche energy, single pulse                 | $E_{AS}$       | $I_D=3.7\text{ A}$ , $V_{DD}=50\text{ V}$ | 246         | mJ                 |
| Avalanche energy, repetitive $t_{AR}^{2),3)}$  | $E_{AR}$       | $I_D=3.7\text{ A}$ , $V_{DD}=50\text{ V}$ | 0.37        |                    |
| Avalanche current, repetitive $t_{AR}^{2),3)}$ | $I_{AR}$       |   | 3.7         | A                  |
| MOSFET dv/dt ruggedness                        | dv/dt          | $V_{DS}=0\dots400\text{ V}$               | 50          | V/ns               |
| Gate source voltage                            | $V_{GS}$       | static                                    | $\pm 20$    | V                  |
|  |                | AC ( $f > 1\text{ Hz}$ )                  | $\pm 30$    |                    |
| Power dissipation                              | $P_{tot}$      | $T_C=25\text{ °C}$                        | 89          | W                  |
| Operating and storage temperature              | $T_j, T_{stg}$ |   | -55 ... 150 | $^{\circ}\text{C}$ |

**Maximum ratings, at  $T_j=25\text{ °C}$ , unless otherwise specified**

| Parameter                           | Symbol        | Conditions         | Value | Unit |
|-------------------------------------|---------------|--------------------|-------|------|
| Continuous diode forward current    | $I_S$         | $T_C=25\text{ °C}$ | 5.6   | A    |
| Diode pulse current <sup>2)</sup>   | $I_{S,pulse}$ |                    | 22    |      |
| Reverse diode $dv/dt$ <sup>4)</sup> | $dv/dt$       |                    | 15    | V/ns |

| Parameter | Symbol | Conditions | Values |      |      | Unit |
|-----------|--------|------------|--------|------|------|------|
|           |        |            | min.   | typ. | max. |      |

**Thermal characteristics**

|  |            |                                       |   |   |     |     |
|--|------------|---------------------------------------|---|---|-----|-----|
| Thermal resistance, junction - case                        | $R_{thJC}$ |                                       | - | - | 1.4 | K/W |
| Thermal resistance, junction - ambient                     | $R_{thJA}$ | leaded                                | - | - | 62  |     |
| Soldering temperature, wavesoldering only allowed at leads | $T_{sold}$ | 1.6 mm (0.063 in.) from case for 10 s | - | - | 260 | °C  |

**Electrical characteristics, at  $T_j=25\text{ °C}$ , unless otherwise specified**
**Static characteristics**

|                                  |               |   |     |      |      |               |
|----------------------------------|---------------|---|-----|------|------|---------------|
| Drain-source breakdown voltage   | $V_{(BR)DSS}$ | $V_{GS}=0\text{ V}, I_D=250\text{ }\mu\text{A}$             | 500 | -    | -    | V             |
| Gate threshold voltage           | $V_{GS(th)}$  | $V_{DS}=V_{GS}, I_D=0.37\text{ mA}$                         | 2.5 | 3    | 3.5  |               |
| Zero gate voltage drain current  | $I_{DSS}$     | $V_{DS}=500\text{ V}, V_{GS}=0\text{ V}, T_j=25\text{ °C}$  | -   | -    | 1    | $\mu\text{A}$ |
|                                  |               | $V_{DS}=500\text{ V}, V_{GS}=0\text{ V}, T_j=150\text{ °C}$ | -   | 10   | -    |               |
| Gate-source leakage current      | $I_{GSS}$     | $V_{GS}=20\text{ V}, V_{DS}=0\text{ V}$                     | -   | -    | 100  | nA            |
| Drain-source on-state resistance | $R_{DS(on)}$  | $V_{GS}=10\text{ V}, I_D=5.6\text{ A}, T_j=25\text{ °C}$    | -   | 0.32 | 0.35 | $\Omega$      |
|                                  |               | $V_{GS}=10\text{ V}, I_D=5.6\text{ A}, T_j=150\text{ °C}$   | -   | 0.80 | -    |               |
| Gate resistance                  | $R_G$         | $f=1\text{ MHz}, \text{open drain}$                         | -   | 2.2  | -    | $\Omega$      |

| Parameter | Symbol | Conditions | Values |      |      | Unit |
|-----------|--------|------------|--------|------|------|------|
|           |        |            | min.   | typ. | max. |      |

**Dynamic characteristics**

|  |              |   |   |      |   |    |
|--|--------------|---|---|------|---|----|
| Input capacitance  | $C_{iss}$    | $V_{GS}=0\text{ V}, V_{DS}=100\text{ V},$<br>$f=1\text{ MHz}$                           | - | 1020 | - | pF |
| Output capacitance   | $C_{oss}$    |   | - | 46   | - |    |
| Effective output capacitance, energy related <sup>5)</sup> | $C_{o(er)}$  | $V_{GS}=0\text{ V}, V_{DS}=0\text{ V}$<br>to 400 V                                      | - | 43   | - |    |
| Effective output capacitance, time related <sup>6)</sup>   | $C_{o(tr)}$  |   | - | 92   | - |    |
| Turn-on delay time   | $t_{d(on)}$  | $V_{DD}=400\text{ V},$<br>$V_{GS}=10\text{ V}, I_D=5.6\text{ A},$<br>$R_G=30.9\ \Omega$ | - | 35   | - | ns |
| Rise time  | $t_r$        |   | - | 14   | - |    |
| Turn-off delay time  | $t_{d(off)}$ |   | - | 80   | - |    |
| Fall time  | $t_f$        |   | - | 12   | - |    |

**Gate Charge Characteristics**

|                       |               |  |   |     |    |    |
|-----------------------|---------------|--|---|-----|----|----|
| Gate to source charge | $Q_{gs}$      | $V_{DD}=400\text{ V}, I_D=5.6\text{ A},$<br>$V_{GS}=0\text{ to }10\text{ V}$ | - | 4   | -  | nC |
| Gate to drain charge  | $Q_{gd}$      |  | - | 6   | -  |    |
| Gate charge total     | $Q_g$         |  | - | 19  | 25 |    |
| Gate plateau voltage  | $V_{plateau}$ |  | - | 5.2 | -  | V  |

**Reverse Diode**

|                               |           |  |   |     |     |               |
|-------------------------------|-----------|--|---|-----|-----|---------------|
| Diode forward voltage         | $V_{SD}$  | $V_{GS}=0\text{ V}, I_F=5.6\text{ A},$<br>$T_j=25\text{ }^\circ\text{C}$ | - | 0.9 | 1.2 | V             |
| Reverse recovery time         | $t_{rr}$  | $V_R=400\text{ V}, I_F=I_S,$<br>$di_F/dt=100\text{ A}/\mu\text{s}$       | - | 250 | -   | ns            |
| Reverse recovery charge       | $Q_{rr}$  |  | - | 2.3 | -   | $\mu\text{C}$ |
| Peak reverse recovery current | $I_{rrm}$ |  | - | 19  | -   | A             |

<sup>1)</sup> J-STD20 and JESD22

<sup>2)</sup> Pulse width  $t_p$  limited by  $T_{j,max}$

<sup>3)</sup> Repetitive avalanche causes additional power losses that can be calculated as  $P_{AV}=E_{AR} \cdot f$ .

<sup>4)</sup>  $I_{SD} \leq I_D, di/dt \leq 400\text{ A}/\mu\text{s}, V_{DClink}=400\text{ V}, V_{peak} < V_{(BR)DSS}, T_j < T_{j,max}$ , identical low and high side switch

<sup>5)</sup>  $C_{o(er)}$  is a fixed capacitance that gives the same stored energy as  $C_{oss}$  while  $V_{DS}$  is rising from 0 to 80%  $V_{DSS}$ .

<sup>6)</sup>  $C_{o(tr)}$  is a fixed capacitance that gives the same charging time as  $C_{oss}$  while  $V_{DS}$  is rising from 0 to 80%  $V_{DSS}$ .

**1 Power dissipation**

$P_{tot}=f(T_C)$

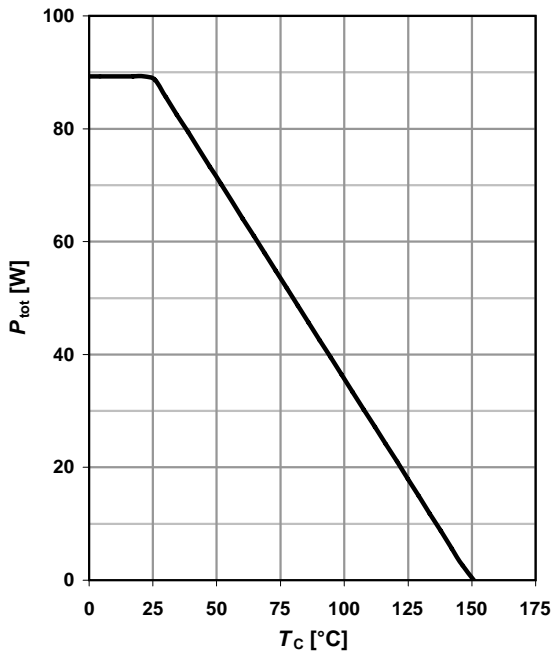

**2 Safe operating area**

$I_D=f(V_{DS}); T_C=25\text{ }^\circ\text{C}; D=0$

parameter:  $t_p$

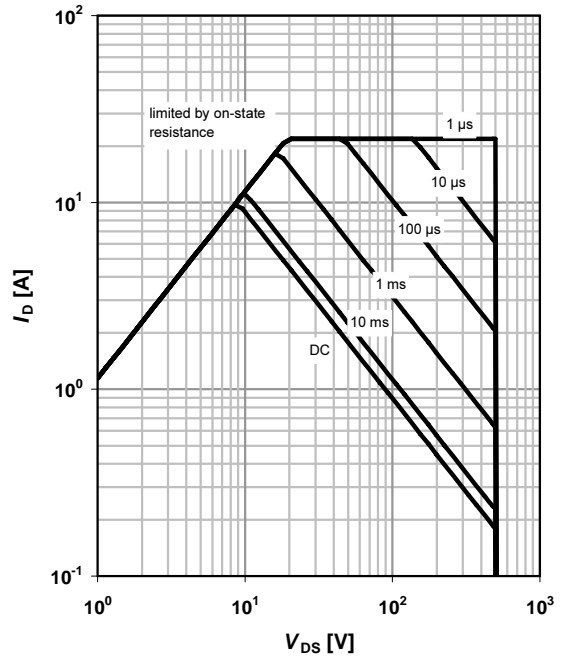

**3 Max. transient thermal impedance**

$Z_{(th)JC}=f(t_p)$

parameter:  $D=t_p/T$

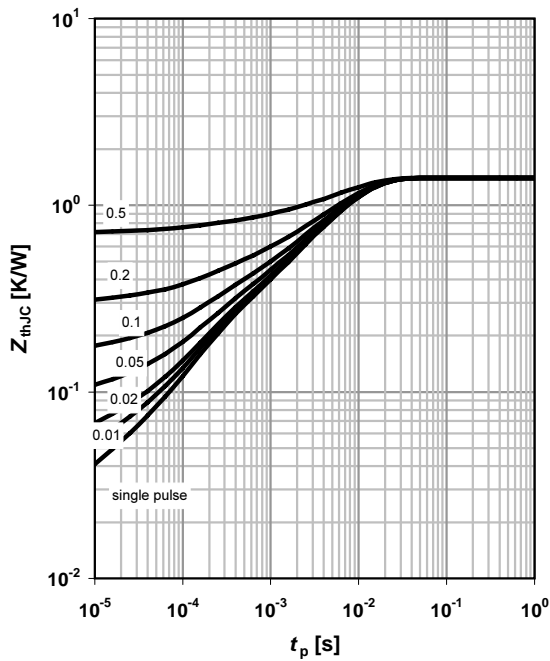

**4 Typ. output characteristics**

$I_D=f(V_{DS}); T_J=25\text{ }^\circ\text{C}$

parameter:  $V_{GS}$

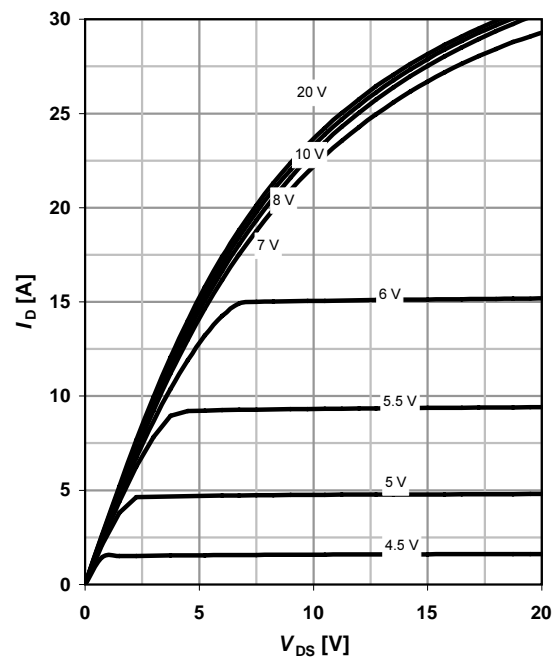

**5 Typ. output characteristics**

$I_D = f(V_{DS}); T_j = 150\text{ °C}$

parameter:  $V_{GS}$

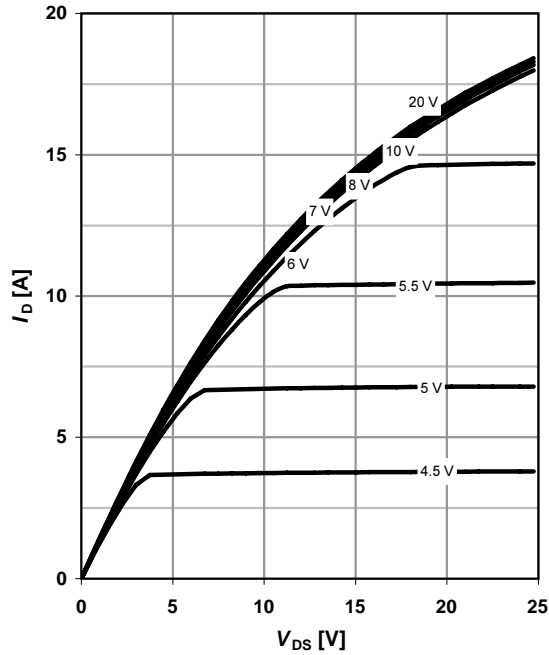

**6 Typ. drain-source on-state resistance**

$R_{DS(on)} = f(I_D); T_j = 150\text{ °C}$

parameter:  $V_{GS}$

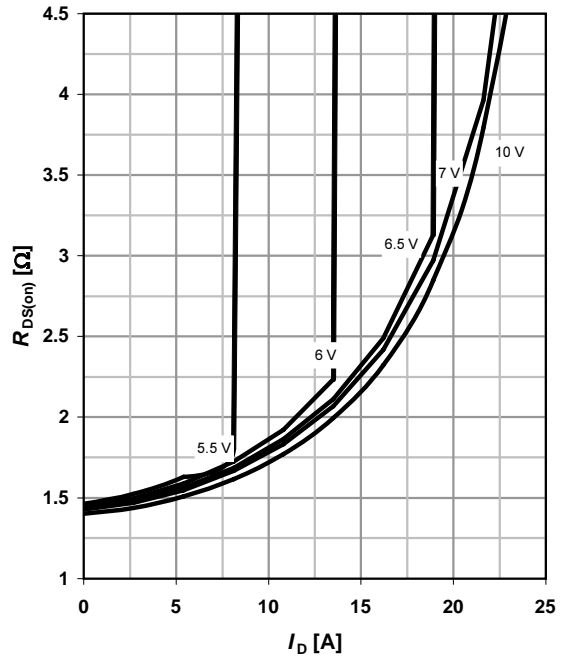

**7 Drain-source on-state resistance**

$R_{DS(on)} = f(T_j); I_D = 5.6\text{ A}; V_{GS} = 10\text{ V}$

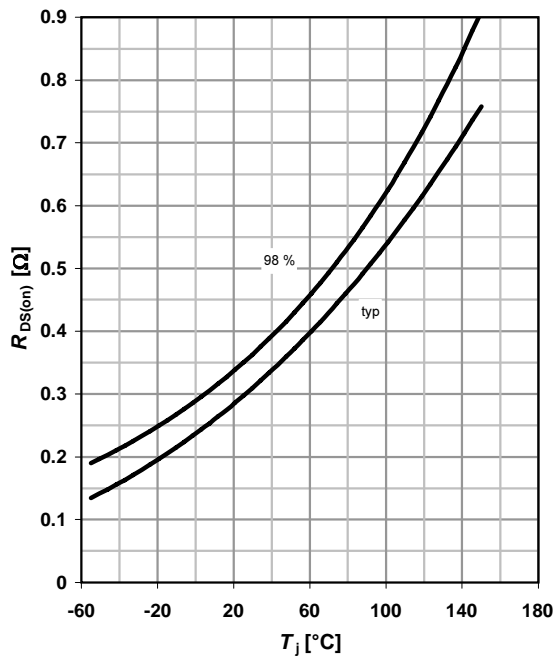

**8 Typ. transfer characteristics**

$I_D = f(V_{GS}); |V_{DS}| > 2|I_D|R_{DS(on)max}$

parameter:  $T_j$

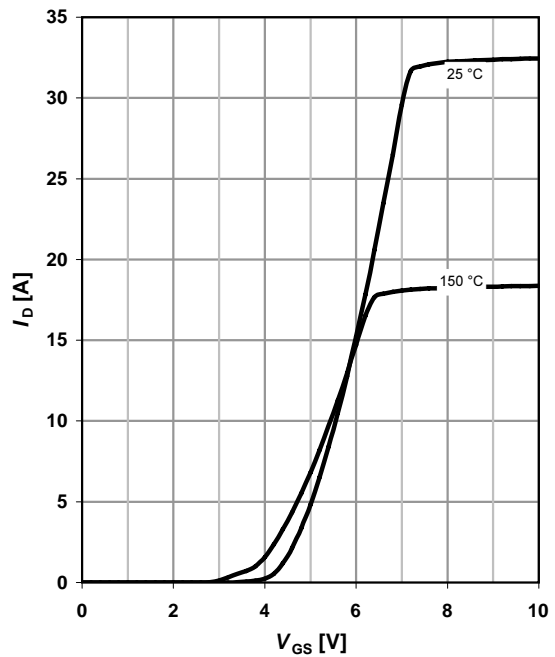

**9 Typ. gate charge**

$V_{GS}=f(Q_{gate}); I_D=5.6 \text{ A pulsed}$

parameter:  $V_{DD}$

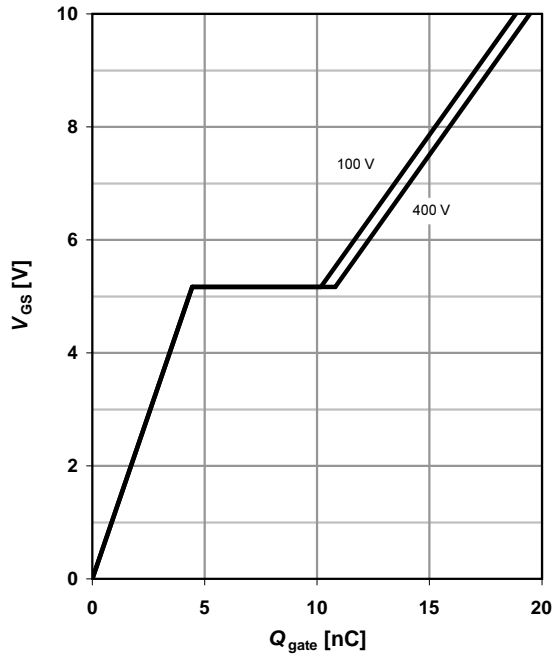

**10 Forward characteristics of reverse diode**

$I_F=f(V_{SD})$

parameter:  $T_j$

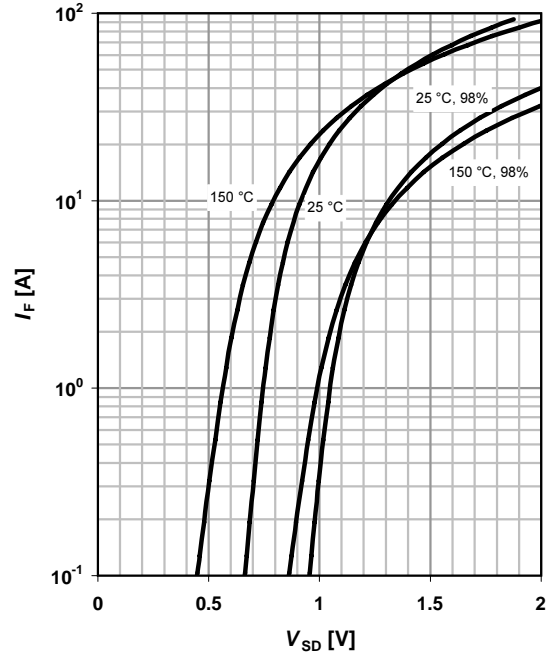

**11 Avalanche energy**

$E_{AS}=f(T_j); I_D=3.7 \text{ A}; V_{DD}=50 \text{ V}$

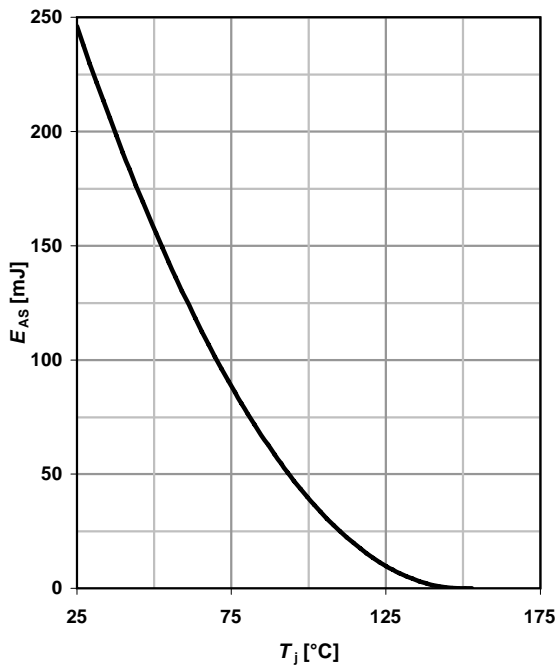

**12 Drain-source breakdown voltage**

$V_{BR(DSS)}=f(T_j); I_D=0.25 \text{ mA}$

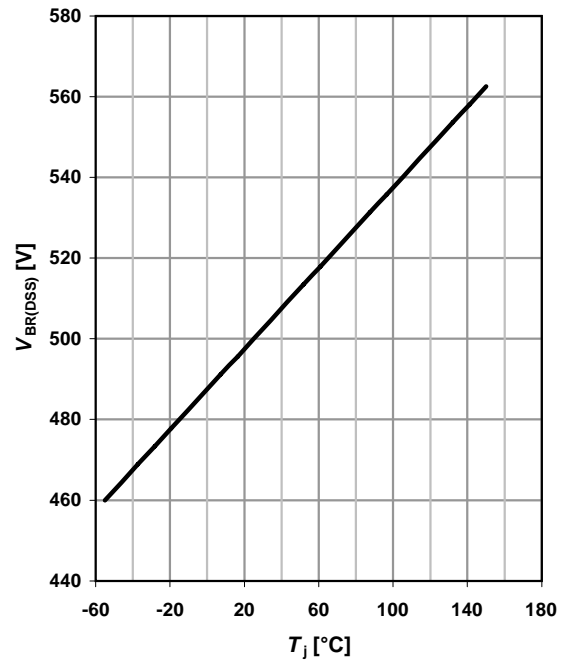

13 Typ. capacitances

$$C = f(V_{DS}); V_{GS} = 0 \text{ V}; f = 1 \text{ MHz}$$

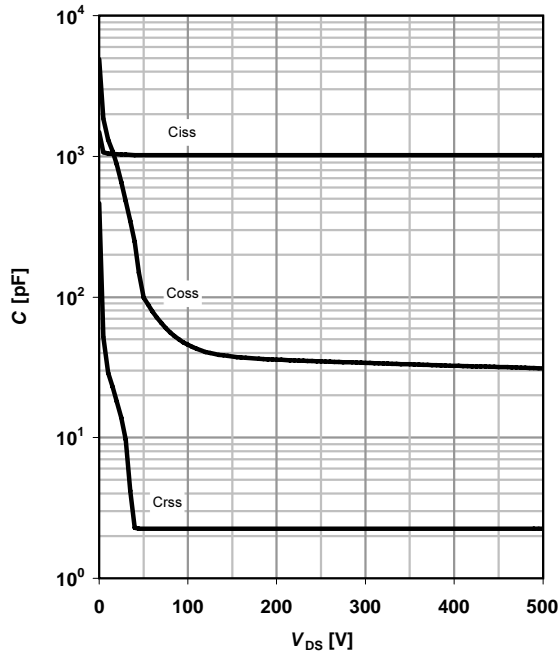

14 Typ. Coss stored energy

$$E_{oss} = f(V_{DS})$$

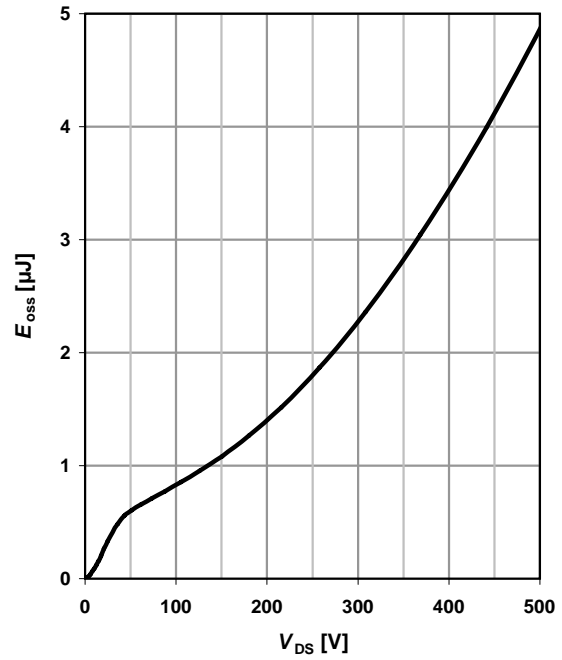

Definition of diode switching characteristics

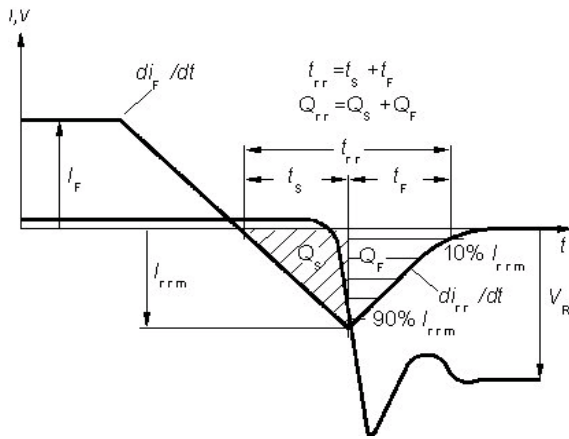

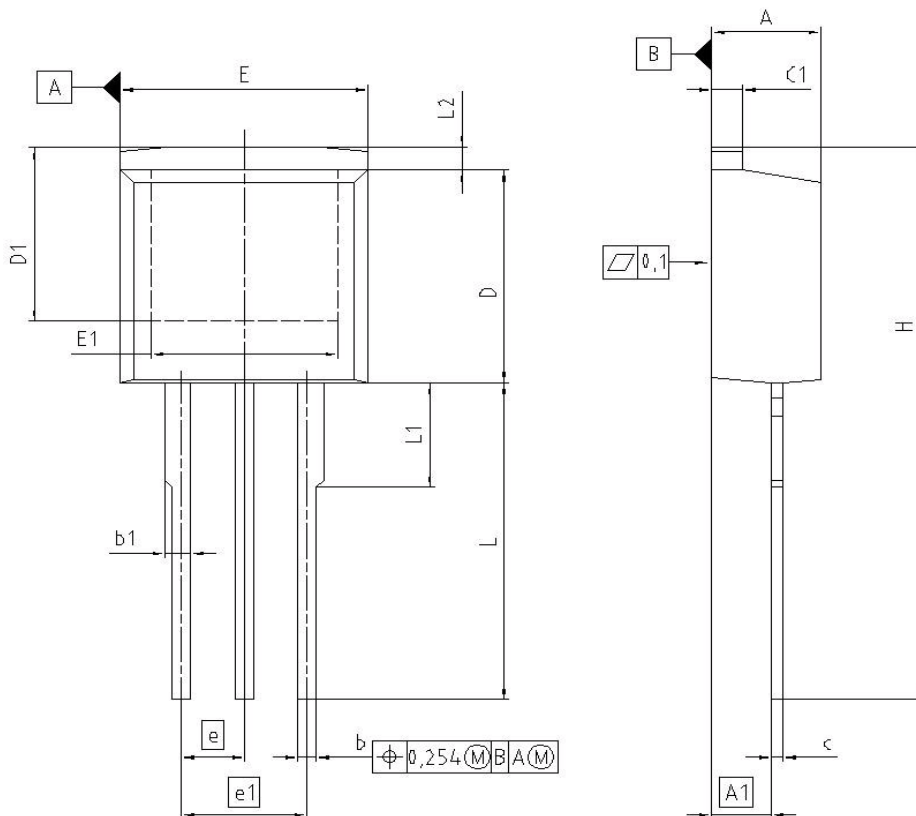

**PG-TO262-3-1: Outline**

| DIM       | MILLIMETERS |        | INCHES |       |
|-----------|-------------|--------|--------|-------|
|           | MIN         | MAX    | MIN    | MAX   |
| <b>A</b>  | 4.300       | 4.500  | 0.169  | 0.177 |
| <b>A1</b> | 2.150       | 2.650  | 0.085  | 0.104 |
| <b>b</b>  | 0.650       | 0.850  | 0.026  | 0.033 |
| <b>b1</b> | 0.635       | 1.400  | 0.025  | 0.055 |
| <b>c</b>  | 0.400       | 0.600  | 0.016  | 0.024 |
| <b>c1</b> | 1.170       | 1.370  | 0.046  | 0.054 |
| <b>D</b>  | 9.050       | 9.450  | 0.356  | 0.372 |
| <b>D1</b> | 6.900       | 7.650  | 0.272  | 0.301 |
| <b>E</b>  | 9.800       | 10.200 | 0.386  | 0.402 |
| <b>E1</b> | 7.250       | 8.600  | 0.285  | 0.339 |
| <b>e</b>  | 2.540       |        | 0.100  |       |
| <b>e1</b> | 5.080       |        | 0.200  |       |
| <b>N</b>  | 3           |        | 3      |       |
| <b>L</b>  | 13.000      | 14.000 | 0.512  | 0.551 |
| <b>L1</b> | 4.350       | 4.750  | 0.171  | 0.187 |
| <b>L2</b> | 0.700       | 1.300  | 0.028  | 0.051 |

|                                 |
|---------------------------------|
| <b>REFERENCE</b><br>JEDEC TO262 |
| <b>SCALE</b><br>                |
| <b>EUROPEAN PROJECTION</b><br>  |
| <b>ISSUE DATE</b><br>01-06-2005 |
| <b>FILE</b><br>TO262_1          |

**Published by**  
Infineon Technologies AG  
81726 Munich, Germany  
© 2007 Infineon Technologies AG  
All Rights Reserved.

**Legal Disclaimer**

The information given in this document shall in no event be regarded as a guarantee of conditions or characteristics. With respect to any examples or hints given herein, any typical values stated herein and/or any information regarding the application of the device, Infineon Technologies hereby disclaims any and all warranties and liabilities of any kind, including without limitation, warranties of non-infringement of intellectual property rights of any third party.

**Information**

For further information on technology, delivery terms and conditions and prices, please contact the nearest Infineon Technologies Office ([www.infineon.com](http://www.infineon.com)).

**Warnings**

Due to technical requirements, components may contain dangerous substances. For information on the types in question, please contact the nearest Infineon Technologies Office. The Infineon Technologies component described in this Data Sheet may be used in life-support devices or systems and/or automotive, aviation and aerospace applications or systems only with the express written approval of Infineon Technologies, if a failure of such components can reasonably be expected to cause the failure of that life-support, automotive, aviation and aerospace device or system or to affect the safety or effectiveness of that device or system. Life support devices or systems are intended to be implanted in the human body or to support and/or maintain and sustain and/or protect human life. If they fail, it is reasonable to assume that the health of the user or other persons may be endangered.

单击下面可查看定价，库存，交付和生命周期等信息

[>>Infineon Technologies\(英飞凌\)](#)

[>>点击查看相关商品](#)