

## CHIP COIL (CHIP INDUCTORS) LQW18AS□□□□00D REFERENCE SPECIFICATION

### 1. Scope

This Reference specification applies to LQW18AS\_00 series, Chip coil (Chip Inductors).

### 2. Part Numbering

(ex) 

LQ	W	18	A	S	1N6	J	0	0	D
Product ID	Structure	Dimension (L×W)	Applications and Characteristics	Category	Inductance	Tolerance	Features	Electrode	Packaging D:Taping *B:Bulk

\*Bulk packing also available. (A product is put in the plastic bag under the taping conditions.)

### 3. Rating

- Operating Temperature Range      −40°C to +125°C (includes self-heating)
- Storage Temperature Range.       −40°C to +125°C

Customer Part Number	MURATA Part Number	Inductance		Q (min.)	DC Resistance (Ω max.)	Self Resonant Frequency (MHz min.)	Rated Current (mA)
		(nH)	Tolerance				
	LQW18AS1N6J00D	1.6	J:±5%	24	0.030	12500	700
	LQW18AS1N8J00D	1.8		16			
	LQW18AS3N3G00D	3.3	G: ±2% J: ±5%	35	0.045	5900	
	LQW18AS3N3J00D						
	LQW18AS3N6G00D	3.6		22	0.063	6900	
	LQW18AS3N6J00D						
	LQW18AS3N9G00D	3.9		20	0.080	5900	
	LQW18AS3N9J00D						
	LQW18AS4N3G00D	4.3		20	0.063	5800	
	LQW18AS4N3J00D						
	LQW18AS4N7G00D	4.7		20	0.116	5700	
	LQW18AS4N7J00D						
	LQW18AS5N1G00D	5.1		26	0.140	4760	
	LQW18AS5N1J00D						
	LQW18AS5N6G00D	5.6		27	0.075	5800	
	LQW18AS5N6J00D						
	LQW18AS6N8G00D	6.8		28	0.110	4800	
	LQW18AS6N8J00D						
	LQW18AS7N5G00D	7.5		30	0.106	4200	
	LQW18AS7N5J00D						
	LQW18AS8N2G00D	8.2		28	0.115	4600	
	LQW18AS8N2J00D						
	LQW18AS8N7G00D	8.7	31	0.109	5400		
	LQW18AS8N7J00D						
	LQW18AS9N5G00D	9.5	31	0.135	4800		
	LQW18AS9N5J00D						
	LQW18AS10NG00D	10	30	0.130	4000		
	LQW18AS10NJ00D						
	LQW18AS11NG00D	11	35	0.086	3300		
	LQW18AS11NJ00D						
	LQW18AS12NG00D	12	34	0.130	3100		
	LQW18AS12NJ00D						
	LQW18AS15NG00D	15	38	0.170	3000		
	LQW18AS15NJ00D						
	LQW18AS16NG00D	16	38	0.104	2850		
	LQW18AS16NJ00D						
	LQW18AS18NG00D	18	38	0.170	3000		
	LQW18AS18NJ00D						
	LQW18AS22NG00D	22	38	0.190	3000		
	LQW18AS22NJ00D						
	LQW18AS23NG00D	23	38	0.190	2850		
	LQW18AS23NJ00D						

MURATA MFG.CO., LTD

Customer Part Number	MURATA Part Number	Inductance		Q (min.)	DC Resistance ( $\Omega$ max.)	Self Resonant Frequency (MHz min.)	Rated Current (mA)	
		(nH)	Tolerance					
	LQW18AS24NG00D LQW18AS24NJ00D	24	G: $\pm 2\%$ J: $\pm 5\%$	36	0.135	2650	700	
	LQW18AS27NG00D LQW18AS27NJ00D	27		40	0.220	2800	600	
	LQW18AS30NG00D LQW18AS30NJ00D	30		37	0.144	2250		
	LQW18AS33NG00D LQW18AS33NJ00D	33		40	0.220	2300		
	LQW18AS36NG00D LQW18AS36NJ00D	36		37	0.250	2080		
	LQW18AS39NG00D LQW18AS39NJ00D	39				40		2200
	LQW18AS43NG00D LQW18AS43NJ00D	43		38	0.280	2000		
	LQW18AS47NG00D LQW18AS47NJ00D	47						
	LQW18AS51NG00D LQW18AS51NJ00D	51		35	0.270	1900		
	LQW18AS56NG00D LQW18AS56NJ00D	56		38	0.310			
	LQW18AS68NG00D LQW18AS68NJ00D	68		37	0.340	1700		400
	LQW18AS72NG00D LQW18AS72NJ00D	72		34	0.490			
	LQW18AS82NG00D LQW18AS82NJ00D	82			0.540			
	LQW18ASR10G00D LQW18ASR10J00D	100			0.580	1400		300
	LQW18ASR11G00D LQW18ASR11J00D	110		32	0.610	1350		
	LQW18ASR12G00D LQW18ASR12J00D	120			0.650	1300		
	LQW18ASR15G00D LQW18ASR15J00D	150		28	0.920	990		280
	LQW18ASR18G00D LQW18ASR18J00D	180		25	1.250			240
	LQW18ASR20G00D LQW18ASR20J00D	200			1.980	900		200
	LQW18ASR21G00D LQW18ASR21J00D	210		27	2.060	895		
	LQW18ASR22G00D LQW18ASR22J00D	220		25	2.100	900		
	LQW18ASR25G00D LQW18ASR25J00D	250			3.550	822	120	
	LQW18ASR27G00D LQW18ASR27J00D	270		24	2.300	900	170	
	LQW18ASR33G00D LQW18ASR33J00D	330		25	3.890		100	
	LQW18ASR39G00D LQW18ASR39J00D	390			4.350			

#### 4. Testing Conditions

《Unless otherwise specified》

Temperature : Ordinary Temperature / 15°C to 35°C  
Humidity : Ordinary Humidity / 25%(RH) to 85%(RH)

《In case of doubt》

Temperature : 20°C $\pm$ 2°C  
Humidity : 60%(RH) to 70%(RH)  
Atmospheric Pressure : 86kPa to 106 kPa

5. Appearance and Dimensions

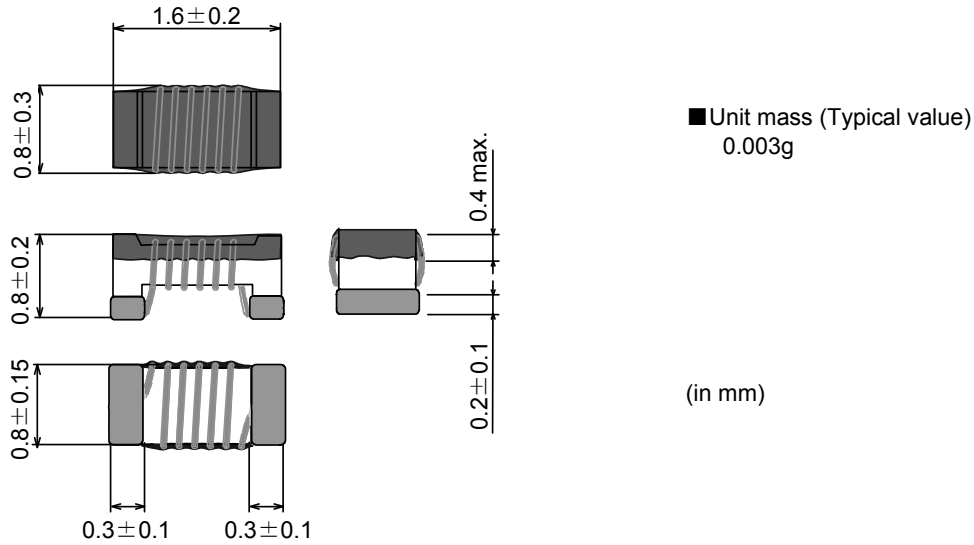

6. Electrical Performance

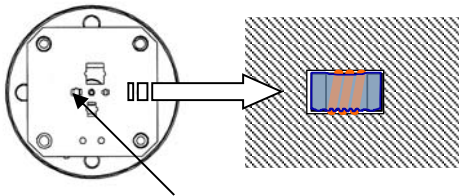
No.	Item	Specification	Test Method
6.1	Inductance	Inductance shall meet item 3.	Measuring Equipment : KEYSIGHT E4982A or equivalent Measuring Frequency : <Inductance> 250MHz / 1.6nH~ 43nH 200MHz / 47nH~ 68nH 150MHz / 72nH~150nH 100MHz / 180nH~390nH <Q> 250MHz / 1.6nH~ 43nH 200MHz / 47nH~ 68nH 150MHz / 72nH~150nH 100MHz / 180nH~390nH Measuring Condition : Test signal level / about 0dBm Electrode spaces / 1.0 mm Electrical length / 1.00mm Measuring Fixture : KEYSIGHT 16197A
6.2	Q	Q shall meet item 3.	Position coil under test as shown in below and contact coil with each terminal by adding weight.  <b>1608 size guide</b> Measuring Method : See the endnote. <Electrical Performance : Measuring Method of Inductance/Q>
6.3	DC Resistance	DC Resistance shall meet item 3.	Measuring Equipment : Digital multi meter
6.4	Self Resonant Frequency(S.R.F)	S.R.F shall meet item 3.	Measuring Equipment : KEYSIGHT N5230A or equivalent

## 7. Mechanical Performance

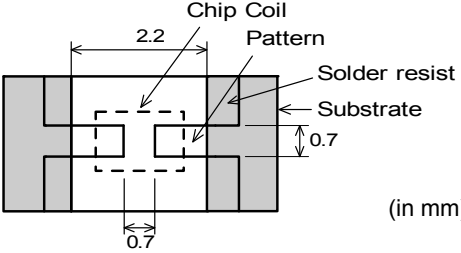
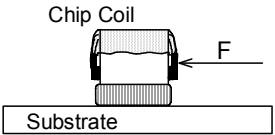
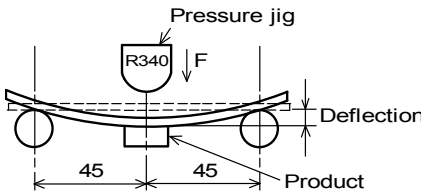
No.	Item	Specification	Test Method
7.1	Shear Test	Chip coil shall not be damaged after tested as test method.	<p>Substrate : Glass-epoxy substrate</p>  <p style="text-align: right;">(in mm)</p> <p>Applied Direction :</p>  <p>Force : 5N Hold Duration : 5s±1s</p>
7.2	Bending Test		<p>Substrate : Glass-epoxy substrate (100mm × 40mm × 1.6mm)</p> <p>Speed of Applying Force : 1mm / s Deflection : 2mm Hold Duration : 30s</p>  <p style="text-align: right;">(in mm)</p>
7.3	Vibration	Chip coil shall not be damaged after tested as test method.	<p>Oscillation Frequency : 10Hz~55Hz~10Hz for 1 min Total Amplitude : 1.5mm Testing Time : A period of 2 hours in each of 3 mutually perpendicular directions.</p>
7.4	Solderability	The wetting area of the electrode shall be at least 90% covered with new solder coating.	<p>Flux : Ethanol solution of rosin,25(wt)% Includes activator equivalent to 0.06(wt)% chlorine.(immersed for 5s to 10s) Solder : Sn-3.0Ag-0.5Cu Pre-Heating : 150°C±10°C / 60s to 90s Solder Temperature : 240°C±5°C Immersion Time : 3s±1s</p>
7.5	Resistance to Soldering Heat	Appearance : No damage Inductance Change : within ±5%	<p>Flux : Ethanol solution of rosin,25(wt)% Includes activator equivalent to 0.06(wt)% Chlorine.(immersed for 5s to 10s) Solder : Sn-3.0Ag-0.5Cu Pre-Heating : 150°C±10°C / 60s to 90s Solder Temperature : 270°C±5°C Immersion Time : 10s±1s Then measured after exposure in the room condition for 24h±2h.</p>

**8. Environmental Performance**

It shall be soldered on the substrate.

No.	Item	Specification	Test Method
8.1	Heat Resistance	Appearance : No damage Inductance Change : within $\pm 5\%$ Q Change : within $\pm 20\%$	Temperature : $125^{\circ}\text{C} \pm 2^{\circ}\text{C}$ Time : 1000h (+48h,0h) Then measured after exposure in the room condition for 24h $\pm$ 2h.
8.2	Cold Resistance		Temperature : $-40^{\circ}\text{C} \pm 2^{\circ}\text{C}$ Time : 1000h (+48h,-0h) Then measured after exposure in the room condition for 24h $\pm$ 2h.
8.3	Humidity		Temperature : $40^{\circ}\text{C} \pm 2^{\circ}\text{C}$ Humidity : 90%(RH) to 95%(RH) Time : 1000h (+48h,-0h) Then measured after exposure in the room condition for 24h $\pm$ 2h.
8.4	Temperature Cycle		1 cycle : 1 step : $-40^{\circ}\text{C} \pm 2^{\circ}\text{C}$ / 30min $\pm$ 3 min 2 step : Ordinary temp. / 10min to 15 min 3 step : $+125^{\circ}\text{C} \pm 2^{\circ}\text{C}$ / 30min $\pm$ 3 min 4 step : Ordinary temp. / 10min to 15 min Total of 10 cycles Then measured after exposure in the room condition for 24h $\pm$ 2h.

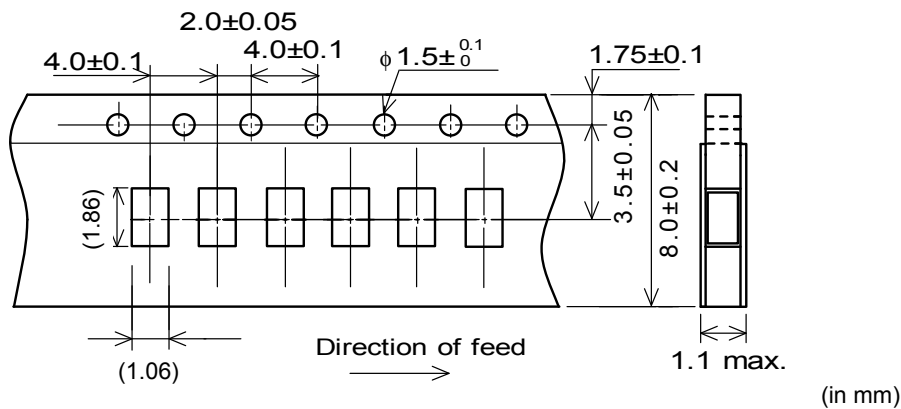
**9. Specification of Packaging****9.1 Appearance and Dimensions of paper tape (8mm-wide)****9.2 Specification of Taping**

- (1) Packing quantity (standard quantity)  
4,000 pcs. / reel
- (2) Packing Method  
Products shall be packed in the cavity of the base tape and sealed by top tape and bottom tape.
- (3) Sprocket hole  
The sprocket holes are to the right as the tape is pulled toward the user.
- (4) Spliced point  
Base tape and Top tape has no spliced point.
- (5) Missing components number  
Missing components number within 0.1 % of the number per reel or 1 pc., whichever is greater, and are not continuous. The Specified quantity per reel is kept.

**9.3 Pull Strength**

Top tape	5N min.
Bottom tape	



**11. Notice**

Products can only be soldered with reflow.  
 This product is designed for solder mounting.  
 Please consult us in advance for applying other mounting method such as conductive adhesive.

**11.1 Land pattern designing**

Recommended land patterns for reflow soldering are as follows:  
 These have been designed for Electric characteristics and solderability.  
 Please follow the recommended patterns. Otherwise, their performance which includes electrical performance or solderability may be affected, or result to "position shift" in soldering process.

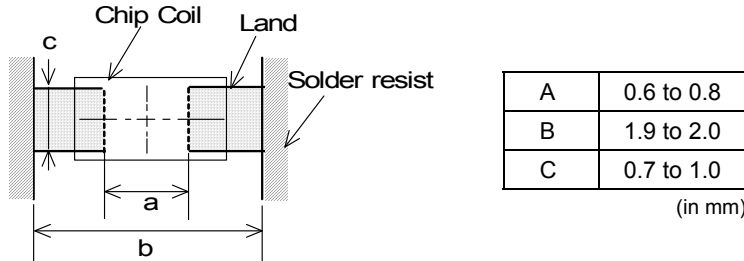

**11.2 Flux, Solder**

- Use rosin-based flux.  
 Includes middle activator equivalent to 0.06(wt)% to 0.1(wt)% Chlorine.  
 Don't use highly acidic flux with halide content exceeding 0.2(wt)% (chlorine conversion value).  
 Don't use water-soluble flux.
- Use Sn-3.0Ag-0.5Cu solder.
- Standard thickness of solder paste : 100 μm to 150 μm.

**11.3 Reflow soldering conditions**

- Pre-heating should be in such a way that the temperature difference between solder and product surface is limited to 150°C max. Cooling into solvent after soldering also should be in such a way that the temperature difference is limited to 100°C max.  
 Insufficient pre-heating may cause cracks on the product, resulting in the deterioration of products quality.
- Standard soldering profile and the limit soldering profile is as follows.  
 The excessive limit soldering conditions may cause leaching of the electrode and / or resulting in the deterioration of product quality.
- Reflow soldering profile

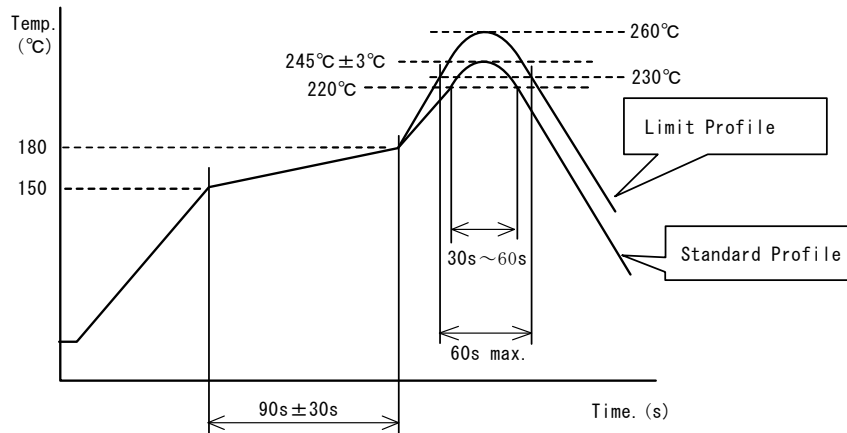

	Standard Profile	Limit Profile
Pre-heating	150°C~180°C , 90s±30s	
Heating	above 220°C, 30s~60s	above 230°C, 60s max.
Peak temperature	245°C±3°C	260°C, 10s
Cycle of reflow	2 times	

**11.4 Reworking with soldering iron**

The following conditions must be strictly followed when using a soldering iron.

Pre-heating	150°C, 1 min
Tip temperature	350°C max.
Soldering iron output	80W max.
Tip diameter	φ3mm max.
Soldering time	3(+1,-0)s
Time	2 times

Note: Do not directly touch the products with the tip of the soldering iron in order to prevent the crack on the products due to the thermal shock.

**11.5 Solder Volume**

- Solder shall be used not to be exceed the upper limits as shown below.
- Accordingly increasing the solder volume, the mechanical stress to Chip is also increased. Exceeding solder volume may cause the failure of mechanical or electrical performance.

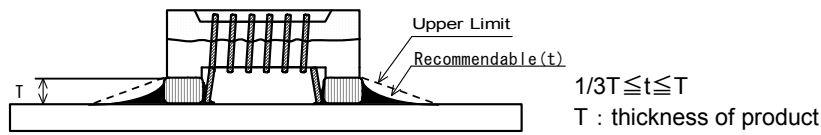

**11.6 Product's location**

The following shall be considered when designing and laying out P.C.B.'s.

- (1) P.C.B. shall be designed so that products are not subject to the mechanical stress due to warping the board.

[Products direction]

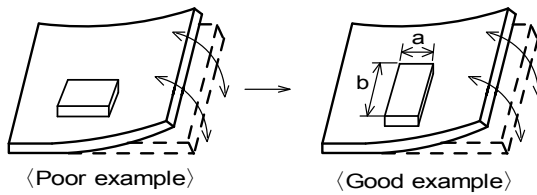

Products shall be located in the sideways direction (Length: a < b) to the mechanical stress.

- (2) Components location on P.C.B. separation.

It is effective to implement the following measures, to reduce stress in separating the board. It is best to implement all of the following three measures; however, implement as many measures as possible to reduce stress.

Contents of Measures	Stress Level
(1) Turn the mounting direction of the component parallel to the board separation surface.	A > D *1
(2) Add slits in the board separation part.	A > B
(3) Keep the mounting position of the component away from the board separation surface.	A > C

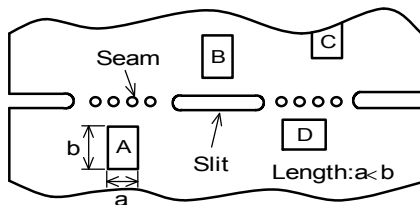

\*1 A > D is valid when stress is added vertically to the perforation as with Hand Separation. If a Cutting Disc is used, stress will be diagonal to the PCB, therefore A > D is invalid.

- (3) Mounting Components Near Screw Holes

When a component is mounted near a screw hole, it may be affected by the board deflection that occurs during the tightening of the screw. Mount the component in a position as far away from the screw holes as possible.

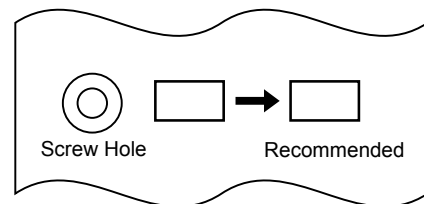



**11.7 Cleaning Conditions**

Products shall be cleaned on the following conditions.

- (1) Cleaning temperature shall be limited to 60°C max.(40°C max for IPA)
- (2) Ultrasonic cleaning shall comply with the following conditions with avoiding the resonance phenomenon at the mounted products and P.C.B.  
Power : 20 W / l max.      Frequency : 28kHz to 40kHz      Time : 5 min max.
- (3) Cleaner
  1. Alcohol type cleaner  
Isopropyl alcohol (IPA)
  2. Aqueous agent  
PINE ALPHA ST-100S
- (4) There shall be no residual flux and residual cleaner after cleaning.  
In the case of using aqueous agent, products shall be dried completely after rinse with de-ionized water in order to remove the cleaner.
- (5) Other cleaning      Please contact us.

**11.8 Resin coating**

The inductance value may change due to high cure-stress of resin to be used for coating/molding products.

An open circuit issue may occur by mechanical stress caused by the resin, amount/cured shape of resin, or operating condition etc. Some resin contains some impurities or chloride possible to generate chlorine by hydrolysis under some operating condition may cause corrosion of wire of coil, leading to open circuit.

So, please pay your careful attention when you select resin in case of coating/molding the products with the resin.

Prior to use the coating resin, please make sure no reliability issue is observed by evaluating products mounted on your board.

**11.9 Caution for use**

- Sharp material such as a pair of tweezers or other material such as bristles of cleaning brush , shall not be touched to the winding portion to prevent the breaking of wire.
- Mechanical shock should not be applied to the products mounted on the board to prevent the breaking of the core.

**11.10 Notice of product handling at mounting**

In some mounting machines,when picking up components support pin pushes up the components from the bottom of base tape. In this case, please remove the support pin. The support pin may damage the components and break wire.

In rare case ,the laser recognition can not recognize this component. Please contact us when you use laser recognition. (There is no problem with the permeation and reflection type.)

**11.11 Handling of a substrate**

After mounting products on a substrate, do not apply any stress to the product caused by bending or twisting to the substrate when cropping the substrate, inserting and removing a connector from the substrate or tightening screw to the substrate.

Excessive mechanical stress may cause cracking in the product.

Bending

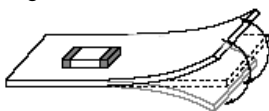

Twisting

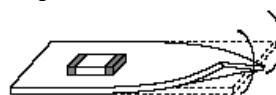
**11.12 Storage and Handling Requirements****(1) Storage period**

Use the products within 12 months after delivered.

Solderability should be checked if this period is exceeded.

**(2) Storage conditions**

- Products should be stored in the warehouse on the following conditions.

Temperature : -10°C to 40°C

Humidity : 15% to 85% relative humidity      No rapid change on temperature and humidity

- Don't keep products in corrosive gases such as sulfur, chlorine gas or acid, or it may cause oxidization of electrode, resulting in poor solderability.
- Products should not be stored on bulk packaging condition to prevent the chipping of the core and the breaking of winding wire caused by the collision between the products.
- Products should be stored on the palette for the prevention of the influence from humidity, dust and so on.
- Products should be stored in the warehouse without heat shock, vibration, direct sunlight and so on.

**(3) Handling Condition**

Care should be taken when transporting or handling product to avoid excessive vibration or mechanical shock.

**12. ⚠ Note**

- (1) Please make sure that your product has been evaluated in view of your specifications with our product being mounted to your product.
- (2) You are requested not to use our product deviating from the reference specifications.
- (3) The contents of this reference specification are subject to change without advance notice.  
Please approve our product specifications or transact the approval sheet for product specifications before ordering.

**< Electrical Performance: Measuring Method of Inductance/Q >**

To keep compatibility to other vender's product, Inductance and Q value shall be measured in following method.

- (1) Residual elements and stray elements of test fixture can be described by F-parameter shown in following.

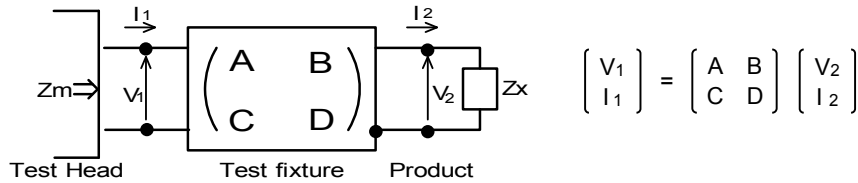

- (2) The impedance of chip coil Zx and measured value Zm can be described by input/output current/voltage.

$$Z_m = \frac{V_1}{I_1}, \quad Z_x = \frac{V_2}{I_2}$$

- (3) Thus, the relation between Zx and Zm is followin

$$Z_x = \alpha \frac{Z_m - \beta}{1 - Z_m \Gamma} \quad \text{where, } \alpha = D / A = 1$$

$$\beta = B / D = Z_{sm} - (1 - Y_{om} Z_{sm}) Z_{ss}$$

$$\Gamma = C / A = Y_{om}$$

- $\left[ \begin{array}{l} Z_{sm} : \text{measured impedance of short chip} \\ Z_{ss} : \text{residual impedance of short chip (=equivalent series Inductance X)} \\ Y_{om} : \text{measured admittance when opening the fixture} \end{array} \right]$

**Important :** X : Zss shall be defined as correction value to fit nominal inductance of other venders' products.  
Please input X value instead of equivalent series Inductance (ShortL) on test equipment calibration.

- (4) Lx and Qx shall be calculated with the following equation.

$$L_x = \frac{\text{Im}(Z_x)}{2\pi f}, \quad Q_x = \frac{\text{Im}(Z_x)}{\text{Re}(Z_x)} \quad f : \text{Measuring frequency}$$

Inductance and Q value shall be measured after this calibration setting.  
In addition, Q value should be measured under our standard calibration setting of residual impedance, 0.771nH.

Chart. equivalent series Inductance to fit nominal inductance of other vendors' products.

MURATA Part Number	Inductance		Q	
	X [nH] equivalent seriesInductance	Measuring Frequency	Short bar correction value [nH]	Measuring Frequency
LQW18AS1N6_00	0.131	250	0.771	250
LQW18AS1N8_00	0.061	250		250
LQW18AS3N3_00	0.111	250		250
LQW18AS3N6_00	0.231	250		250
LQW18AS3N9_00	0.011	250		250
LQW18AS4N3_00	0.251	250		250
LQW18AS4N7_00	0.301	250		250
LQW18AS5N1_00	0.071	250		250
LQW18AS5N6_00	-0.079	250		250
LQW18AS6N8_00	-0.019	250		250
LQW18AS7N5_00	0.201	250		250
LQW18AS8N2_00	0.281	250		250
LQW18AS8N7_00	0.221	250		250
LQW18AS9N5_00	0.021	250		250
LQW18AS10N_00	-0.089	250		250
LQW18AS11N_00	0.321	250		250
LQW18AS12N_00	-0.189	250		250
LQW18AS15N_00	-0.369	250		250
LQW18AS16N_00	0.271	250		250
LQW18AS18N_00	-0.429	250		250
LQW18AS22N_00	-0.419	250		250
LQW18AS23N_00	-0.509	250		250
LQW18AS24N_00	0.401	250		250
LQW18AS27N_00	0.171	250		250
LQW18AS30N_00	-0.219	250		250
LQW18AS33N_00	-0.589	250		250
LQW18AS36N_00	-0.299	250		250
LQW18AS39N_00	-0.859	250		250
LQW18AS43N_00	0.231	250		250
LQW18AS47N_00	-0.769	200		200
LQW18AS51N_00	-0.949	200		200
LQW18AS56N_00	-1.299	200		200
LQW18AS68N_00	-1.739	200		200
LQW18AS72N_00	-1.089	150		150
LQW18AS82N_00	-1.909	150		150
LQW18ASR10_00	-1.729	150		150
LQW18ASR11_00	-2.829	150		150
LQW18ASR12_00	-3.429	150		150
LQW18ASR15_00	-4.429	150		150
LQW18ASR18_00	-5.129	100		100
LQW18ASR20_00	-4.629	100	100	
LQW18ASR21_00	-2.029	100	100	
LQW18ASR22_00	-5.229	100	100	
LQW18ASR25_00	-4.029	100	100	
LQW18ASR27_00	-4.329	100	100	
LQW18ASR33_00	-8.329	100	100	
LQW18ASR39_00	-13.329	100	100	

单击下面可查看定价，库存，交付和生命周期等信息

[>>Murata\(村田\)](#)

[>>点击查看相关商品](#)