

1A Driver Transistor Built-In, Multi Functional Step-Up DC/DC Converters

GreenOperation Compatible

GENERAL DESCRIPTION

XC9135/XC9136 series are synchronous step-up DC/DC converters with a 0.2 (TYP.) N-channel driver transistor and a 0.2 (TYP.) synchronous P-channel switching transistor built-in. A highly efficient and stable current can be supplied up to 1.0A by reducing ON resistance of the built-in transistors.

The series are able to start operation under the condition which has 0.9V input voltage to generate 3.3V output voltage with a 33 load resistor, suitable for mobile equipment using only one Alkaline battery or one Nickel metal hydride battery.

During the operation of a shutdown, the load disconnection function enables to cut the current conduction path from the input to the output.

The output voltage is selectable in 0.1V increments within 1.8~5.0V ($\pm 2.0\%$ accuracy).

The UVLO function of the XC9135 series is capable to reduce leaking potassium hydroxide by stopping IC operation while battery voltage is declining. The release voltages of UVLO are 0.85V ($\pm 6.0\%$ accuracy) and 1.6V ($\pm 3.0\%$ accuracy), and selectable voltages range of 0.9V~3.0V.

APPLICATIONS

Digital audio equipments
Digital still cameras / Camcorders
Computer mouses
Multi-function power supplies

FEATURES

Input Voltage Range	: 0.65V ~ 5.5V
Fixed Output Voltages	: 1.8V ~ 5.0V (0.1V increments)
Oscillation Frequency	: 1.2MHz ($\pm 15\%$)
Input Current	: 1.0A
Output Current	: 500mA @ $V_{OUT}=3.3V, V_{IN}=1.8V$ (TYP.)
Control Mode Selection	: PWM or Auto PWM/PFM
Load Transient Response	: 100mV $V_{OUT}=3.3V, V_{IN}=1.8V, I_{OUT}=1mA$ 200mA
Protection Circuits	: Thermal shutdown Over-current limit Integral latch method
Functions	: Soft-start Load Disconnection Function C_L Auto Discharge Function Flag-out Function UVLO
Output Capacitor	: Ceramic Capacitor
Operating Ambient Temperature	: -40 ~ +85
Package	: USP-10B
Environmentally Friendly	: EU RoHS Compliant, Pb Free

TYPICAL APPLICATION CIRCUIT

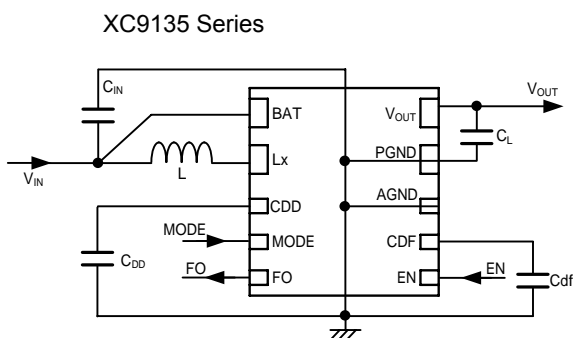

TYPICAL PERFORMANCE CHARACTERISTICS

Efficiency vs. Output Current

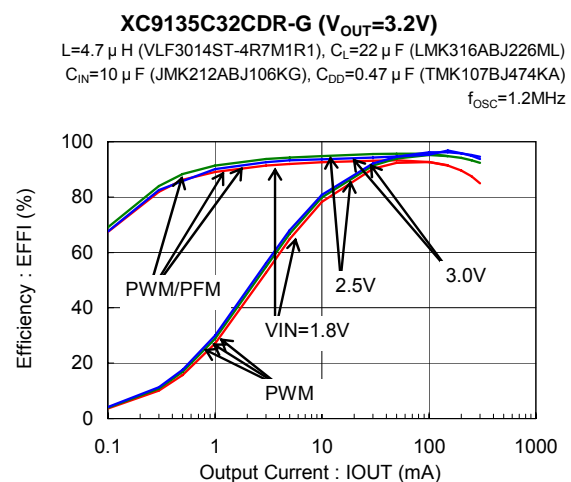

PIN CONFIGURATION

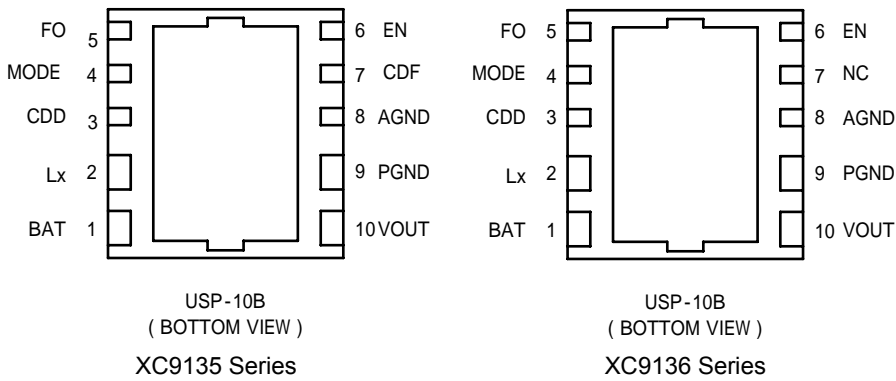

PIN ASSIGNMENT

PIN NUMBER		PIN NAME	FUNCTIONS
XC9135 series	XC9136 series		
1	1	BAT	Power Input
2	2	Lx	Switching
3	3	CDD	Bypass Capacitor Connection
4	4	MODE	Mode Switching
5	5	FO	Flag Output
6	6	EN	Enable
7	-	CDF	UVLO Detect Delay Capacitor Connection
-	7	NC	No Connection
8	8	AGND	Analog Ground
9	9	PGND	Power Ground
10	10	VOUT	Output Voltage

* The dissipation pad for the USP-10B package should be solder-plated in recommended mount pattern and metal masking so as to enhance mounting strength and heat release.

If the pad needs to be connected to other pins, it should be connected to the AGND (No.8) or PGND (No.9) pin.

*Please short the GND pins (pins 8 and 9).

FUNCTION CHART

1. EN Pin Function

XC9135/XC9136 series

EN PIN	FUNCTIONS
H	Operation
L	Stop

* Do not leave the EN pin open.

2. MODE Pin Function

XC9135/XC9136 series

MODE PIN	FUNCTIONS
H	PWM
L	PWM/PFM automatic control

* Do not leave the MODE pin open.

PRODUCT CLASSIFICATION

Ordering Information

- XC9135 - ⁽¹⁾.....V_{OUT} product with UVLO integral latch protection
 XC9136 - ⁽¹⁾.....V_{OUT} product

DESIGNATOR	ITEM	SYMBOL	DESCRIPTION ⁽²⁾ (.....With the functions xWithout the functions)						
			UVLO 0.85V	UVLO 1.6V	UVLO 1.2V Outside Standard	UVLO > 1.2V Outside Standard	UVLO DETECT DELAY	LATCH PROTECTION	C _L AUTO DISCHARGE ⁽³⁾
	XC9135 series Output voltage internally fixed(V _{OUT})	A	x		x	x			
		C	x		x	x			x
		B		x	x	x			
		K		x	x	x			x
	XC9135 series Semi custom ⁽⁵⁾	L	x	x	x				
		M	x	x	x				x
		R	x	x		x			
		T	x	x		x			x
	XC9136 series Output voltage internally fixed(V _{OUT})	E	x	x	x	x	x	x	
		N	x	x	x	x	x	x	x
Output Voltage (V _{OUT}) (XC9135A,C Series)	28 ~ 50	Output Voltage ⁽⁴⁾ e.g. V _{OUT} =5.0V =5, =0							
	18 ~ 50	Output Voltage ⁽⁴⁾ e.g. V _{OUT} =1.8V =1, =8							
	01 ~ 99	Semi custom serial numbers starting from 01 ⁽⁵⁾							
	Oscillation Frequency	C	1.2MHz						
- ⁽¹⁾	Package (Order Unit)	DR-G	USP-10B (3,000/Reel) ⁽⁶⁾						

⁽¹⁾ The "-G" suffix indicates that the products are Halogen and Antimony free as well as being fully EU RoHS compliant.

⁽²⁾ The SYMBOL of DESIGNATOR is decided by the combination of with or without "UVLO", "UVLO DETECT DELAY", "FO", "LATCH PROTECTION", and "C_L DISCHARGE".

Example:With the functions xWithout the functions

⁽³⁾ Example:V_{OUT} pin can not be connected to the different output pin such as another supply (AC adaptor).

xV_{OUT} pin can be connected to the different output pin such as another supply (AC adaptor).

⁽⁴⁾ The XC9135A, XC9135C, XC9135L, XC9135M limit their selection rang in 2.8V to 5V. The other products have the range from 1.8V to 5V.

⁽⁵⁾ The XC9135L, XC9135M, XC9135R, XC9135T are semi-custom products. Please consult with your Torex sales contact.

⁽⁶⁾ The XC9135/XC9136 reels are shipped in a moisture-proof packing. Please consult with your Torex sales contact.

BLOCK DIAGRAMS

XC9135A/XC9135B/XC9135L/XC9135R Series

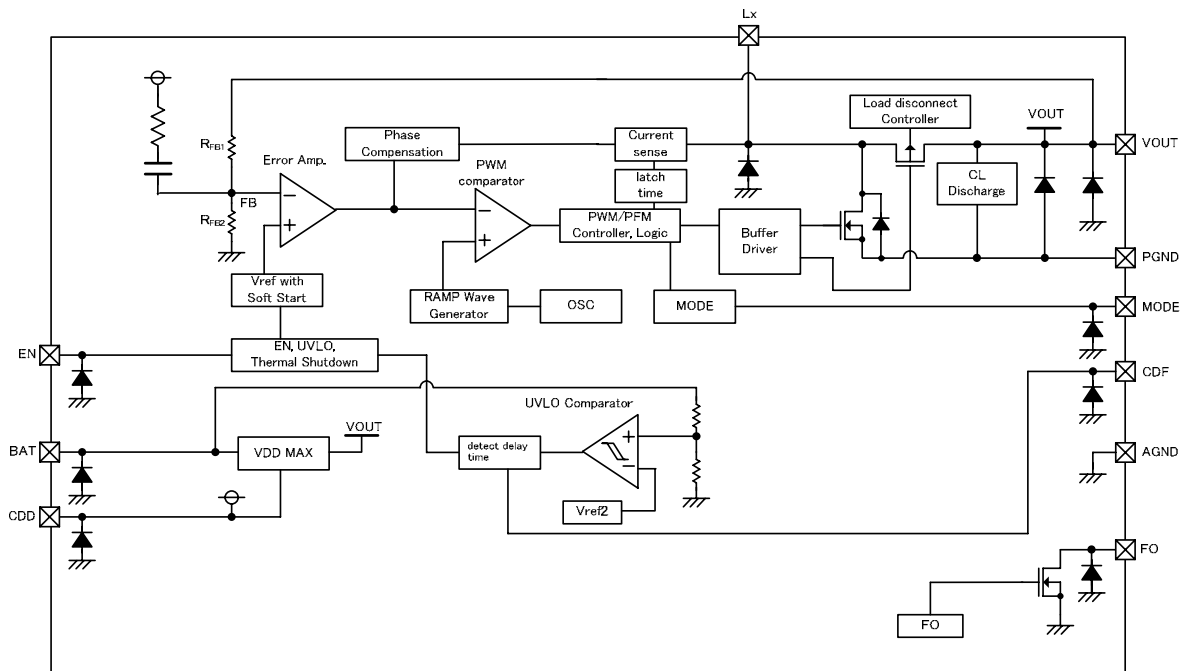

* Diodes inside the circuit are an ESD protection diode and a parasitic diode.

XC9135C/XC9135K/XC9135M/XC9135T Series

XC9135C/XC9135K/XC9135M/XC9135T series does not have C_L discharge function.

XC9136E Series

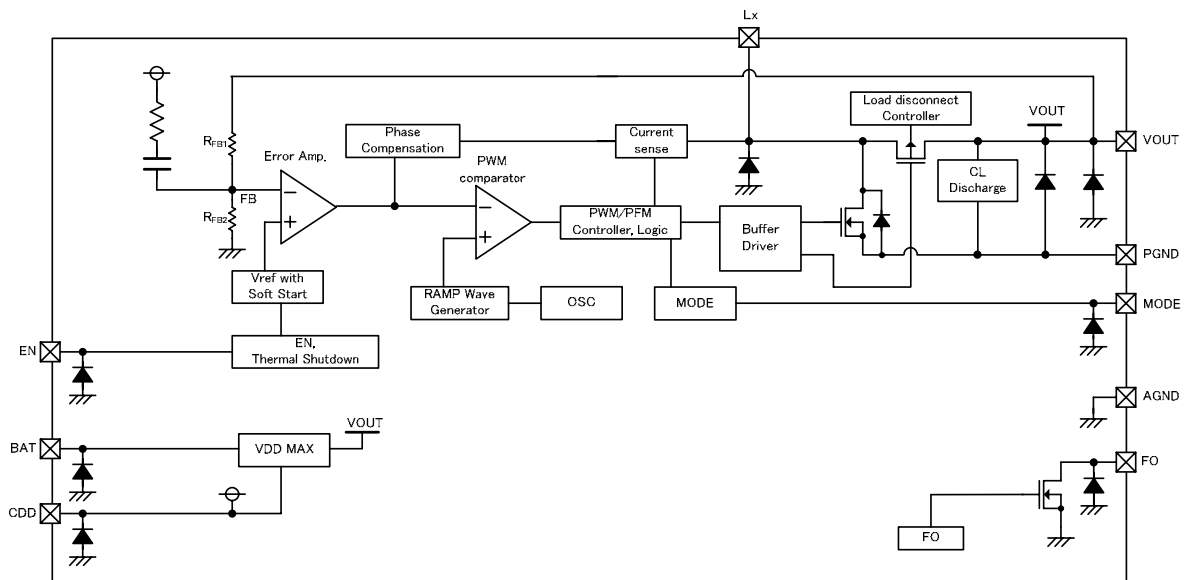

*Diodes inside the circuit are an ESD protection diode and a parasitic diode.

XC9136N Series

XC9136N series does not have C_L discharge function.

ABSOLUTE MAXIMUM RATINGS

Ta=25

PARAMETER		SYMBOL	RATINGS	UNITS
V _{OUT} Pin Voltage		V _{OUT}	-0.3 ~ 7.0	V
C _{DD} Pin Voltage		V _{CDD}	-0.3 ~ 7.0	V
FO Pin Voltage		V _{FO}	-0.3 ~ 7.0	V
FO Pin Current		I _{FO}	10	mA
C _{DF} Pin Voltage ^(*)		V _{CDF}	-0.3 ~ 7.0	V
BAT Pin Voltage		V _{BAT}	-0.3 ~ 7.0	V
MODE Pin Voltage		V _{MODE}	-0.3 ~ 7.0	V
EN Pin Voltage		V _{EN}	-0.3 ~ 7.0	V
Lx Pin Voltage		V _{Lx}	-0.3 ~ V _{OUT} +0.3	V
Lx Pin Current		I _{Lx}	± 2000	mA
Power Dissipation	USP-10B	P _d	150	mW
Operating Ambient Temperature		T _{opr}	-40 ~ +85	
Storage Temperature		T _{stg}	-55 ~ +125	

* AGND and PGND are standard voltage for all of the voltage.

^(*) For only the XC9135 series. The XC9136 series does not have the C_{DF} pin.

ELECTRICAL CHARACTERISTICS

XC9135A/XC9135C/XC9135B/XC9135K

Ta=25

PARAMETER	SYMBOL	CONDITIONS	MIN	TYP	MAX	UNITS	CIRCUIT
Input Voltage	V _{IN}				5.5	V	
Output Voltage	V _{OUT}	V _{IN} =V _{UVLO_R(E)} +0.1V R _L is selected with V _{OUT(E)} , Refer to F1 Table	E1			V	
Operation Start Voltage	V _{ST1}	R _L =1kΩ, V _{MODE} =0V			V _{UVLO_R}	V	
Operation Start Voltage XC9135A/C		V _{MODE} =0V, V _{OUT(E)} 3.3V, I _{OUT} =100mA			V _{UVLO_R} ^(*1)		
Operation Start Voltage XC9135B/K		V _{OUT(E)} >3.3V, I _{OUT} =50mA			0.9 ^(*1)		
Operation Hold Voltage	V _{HLD}	R _L =1kΩ, V _{MODE} =0V		V _{UVLO_F}		V	
Supply Current	I _q		E2			μA	
Input Pin Current XC9135A/C	I _{BAT}	V _{IN} =V _{OUT(E)} -0.2V, V _{EN} =3.3V		1.1	4.0	μA	
Input Pin Current XC9135B/K				1.5	6.0		
Stand-by Current XC9135A	I _{STB}	V _{IN} =V _{OUT(E)}		0.2	3.5	μA	
Stand-by Current XC9135B				0.2	4.5		
Stand-by Current XC9135C/K				1.0	6.0		
Lx Leakage Current	I _{LxL}	V _{IN} =V _{Lx} =V _{OUT(E)}		0.1	2.0	μA	
Oscillation Frequency	f _{OSC}	V _{IN} =V _{PULL} =(V _{OUT(E)} +V _{UVLO_R(E)})/2	1.02	1.20	1.38	MHz	
Maximum Duty Cycle	D _{MAX}	V _{IN} =V _{PULL} =(V _{OUT(E)} +V _{UVLO_R(E)})/2	86.5	93.0	98.0	%	
Minimum Duty Cycle	D _{MIN}	V _{IN} =V _{OUT(E)} +0.5V, R _L is selected with V _{OUT(E)} , Refer to F1 Table			0	%	
PFM Switching Current	I _{PFM}	V _{MODE} =0V, R _L is selected with V _{OUT(E)} , Refer to F1 Table		250	350	mA	
Efficiency ^(*2)	EFFI	I _{OUT} =100mA, V _{MODE} =0V, V _{FO} :OPEN		93		%	
Lx SW "Pch" ON Resistance	R _{LxP}	I _{OUT} =200mA ^(*3)		0.20	0.35 ^(*1)		
Lx SW "Nch" ON Resistance	R _{LxN}	^(*4)		0.20 ^(*1)	0.35 ^(*1)		
Maximum Current Limit	I _{LIM}		E3			A	
Integral Latch Time	t _{LAT}	V _{IN} =(V _{OUT(E)})/2, time to stop Lx oscillation from becoming FO="H"	0.5	2.0	4.0	ms	
Soft-Start Time	t _{SS}	V _{IN} =V _{PULL} =(V _{OUT(E)} +V _{UVLO_R(E)})/2, V _{OUT} =V _{OUT(E)} ×0.95 After V _{EN} =0V 3.3V, time to FO=L	2.6	5.0	8.5	ms	
Thermal Shut Temperature	T _{TSD}			150			
Hysteresis Width	T _{HYS}			20			
C _L Discharge Resistance XC9135A/B ^(*8)	R _{DCHG}	V _{IN} =V _{OUT} =2.0V ^(*5)	100	200	400	Ω	
FO ON Resistance	R _{FO}	V _{EN} =3.3V, V _{FO} =0.5V, V _{OUT(E)} <3.3V ^(*6)	100	200	250	Ω	
		V _{EN} =3.3V, V _{FO} =0.5V, V _{OUT(E)} 3.3V ^(*6)		150	200		
FO Leakage Current	I _{FO_LEAK}	V _{FO} =5.5V		0	1	μA	
EN "H" Voltage	V _{ENH}	V _{IN} =V _{PULL} =(V _{OUT(E)} +V _{UVLO_R(E)})/2, While V _{EN} =0.20V 0.75V, Voltage to start oscillation	0.75		5.5	V	
EN "L" Voltage	V _{ENL}	V _{IN} =V _{PULL} =(V _{OUT(E)} +V _{UVLO_R(E)})/2, While V _{EN} =0.75V 0.20V, Voltage to stop oscillation	AGND		0.2	V	
MODE "H" Voltage	V _{MODEH}	Voltage for PWM Control R _L is selected with V _{OUT(E)} , Refer to F1 Table	0.75		5.5	V	
MODE "L" Voltage	V _{MODEL}	Voltage for PFM Control R _L is selected with V _{OUT(E)} , Refer to F1 Table	AGND		0.2	V	

ELECTRICAL CHARACTERISTICS (Continued)

XC9135A/XC9135C/XC9135B/XC9135K

Ta=25

PARAMETER	SYMBOL	CONDITIONS	MIN	TYP	MAX	UNITS	CIRCUIT
EN "H" Current	I_{ENH}	$V_{IN}=V_{EN}=5.5V$			0.1	μA	
EN "L" Current	I_{ENL}	$V_{IN}=5.5V, V_{EN}=0V$	-0.1			μA	
MODE "H" Current	I_{MODEH}	$V_{IN}=V_{EN}=V_{MODE}=5.5V$			0.1	μA	
MODE "L" Current	I_{MODEL}	$V_{IN}=V_{EN}=5.5V, V_{MODE}=0V$	-0.1			μA	
UVLO Release Voltage XC9135A/C	V_{UVLO_R}	$R_L=1k$, While $V_{IN}=0.2V$ 3.3V, Voltage to start oscillation	1.552	1.600	1.648	V	
UVLO Release Voltage XC9135B/K			0.799	0.850	0.901		
UVLO Hysteresis Width XC9135A/C	V_{UVLO_HYS}	(*)	0.10	0.14	0.20	V	
UVLO Hysteresis Width XC9135B/K			0.05				
Output Voltage Drop Protection XC9135B/K (*)	V_{LVP}	While $V_{OUT}=1.7V$ 1.3V, Voltage to stop oscillation	1.4	1.5	1.6	V	
UVLO Detect Delay	t_{DF}	After $V_{IN}=V_{PULL}=(V_{OUT(E)}+V_{UVLO_R(E)})/2$ 0.65V, time to stop oscillation	0.5	1.0	1.5	ms	

External Components: $C_{IN}=10 \mu F$ (ceramic), $L=2.2 \mu H$ (VLCF4020 TDK), $C_{DD}=0.47 \mu F$ (ceramic), $C_L=22 \mu F$ (ceramic), $C_{DF}=1000pF$ (ceramic)

Test Conditions

For the Circuit No.1, unless otherwise stated, $V_{IN}=(V_{OUT(E)}+V_{UVLO_R(E)})/2, V_{EN}=V_{MODE}=V_{FO}=3.3V$

For the Circuit No.2, unless otherwise stated, $V_{IN}=V_{EN}=V_{OUT(E)}+0.5V, V_{MODE}=0V$ (GND connected), $C_{DF}:OPEN$

For the Circuit No.3, unless otherwise stated, $V_{OUT}=V_{EN}=V_{MODE}=0V$ (GND connected), $C_{DF}:OPEN$

For the Circuit No.4, unless otherwise stated, $V_{OUT}=V_{EN}=V_{MODE}=0V$ (GND connected), $C_{DF}:OPEN$

For the Circuit No.5, unless otherwise stated, $V_{IN}=V_{PULL}=1.5V, V_{OUT}=V_{EN}=V_{MODE}=V_{FO}=V_{OUT(E)}-0.1V,$

For the Circuit No.6, unless otherwise stated, $V_{OUT}=V_{OUT(E)}+0.5V, V_{EN}=V_{MODE}=0V$ (GND connected), $C_{DF}:OPEN$

For the Circuit No.7, unless otherwise stated, $V_{IN}=V_{OUT(E)}+0.5V, V_{EN}=V_{MODE}=0V$ (GND connected), $C_{DF}:OPEN$

For the Circuit No.8, unless otherwise stated, $V_{IN}=V_{LX}=V_{OUT(E)}+0.5V, V_{EN}=V_{MODE}=3.3V, C_{DF}:OPEN$

For the Circuit No.9, unless otherwise stated, $V_{IN}=1.1V, V_{OUT}=1.6V, V_{EN}=3.3V, V_{MODE}=V_{FB}(C_{DF})=0V$ (GND connected)

$V_{OUT(E)}$ = Output Voltage Setting

$V_{UVLO_R(E)}$ =UVLO Voltage Setting

$V_{UVLO_F}=V_{UVLO_R}-V_{UVLO_HYS}$

(*)1) Designed value

(*)2) Efficiency = $\frac{\{(output\ voltage) \times (output\ current)\}}{\{(input\ voltage) \times (input\ current)\}} \times 100$

(*)3) L_X SW "P-ch" ON resistance = $(V_{LX}-V_{OUT\ pin\ test\ voltage}) \div 200mA$

(*)4) Testing method of L_X SW "N-ch" ON resistance is stated at test circuits.

(*)5) C_L Discharge resistance = $V_{OUT} \div V_{OUT\ pin\ measure\ current}$

(*)6) FO ON resistance = $V_{FO} \div FO\ pin\ measure\ current$

(*)7) The Voltage is a difference between V_{UVLO_R} and the voltage to stop oscillation for L_X pin while $V_{IN}=V_{UVLO_R}-0.2V, R_L=1k$

(*)8) The XC9135C, XC9135K series does not have C_L discharge function. For XC9135A, XC9135B.

(*)9) The XC9135A, XC9135C series does not have output voltage drop protection. For XC9135B, XC9135K.

ELECTRICAL CHARACTERISTICS (Continued)

XC9136E/XC9136N

Ta=25

PARAMETER	SYMBOL	CONDITIONS	MIN	TYP	MAX	UNITS	CIRCUIT
Input Voltage	V _{IN}				5.5	V	
Output Voltage	V _{OUT}	R _L is selected with V _{OUT(E)} , Refer to F1 Table	E1			V	
Operation Start Voltage	V _{ST1}	R _L =1kΩ, V _{MODE} =0V			0.85	V	
		V _{MODE} =0V, V _{OUT(E)} 3.3V, I _{OUT} =100mA V _{OUT(E)} >3.3V, I _{OUT} =50mA			0.9 ^(*)		
Operation Hold Voltage	V _{HLD}	R _L =1kΩ, V _{MODE} =0V		0.65		V	
Supply Current	I _q			36	52	μA	
Input Pin Current	I _{BAT}	V _{IN} =V _{OUT(E)} -0.2V, V _{EN} =3.3V		0.65	2.15	μA	
Stand-by Current XC9136E	I _{STB}	V _{IN} =V _{OUT(E)}		0.1	2.0	μA	
Stand-by Current XC9136N				0.9	5.0		
Lx Leakage Current	I _{LxL}	V _{IN} =V _{Lx} =V _{OUT(E)}		0.1	2.0	μA	
Oscillation Frequency	f _{OSC}	V _{IN} =V _{PULL} =V _{OUT(E)} /2	1.02	1.20	1.38	MHz	
Maximum Duty Cycle	D _{MAX}		86.5	93.0	98.0	%	
Minimum Duty Cycle	D _{MIN}	V _{IN} =V _{OUT(E)} +0.5V, R _L is selected with V _{OUT(E)} , Refer to F1 Table			0	%	
PFM Switching Current	I _{PFM}	V _{MODE} =0V, R _L is selected with V _{OUT(E)} , Refer to F1 Table		250	350	mA	
Efficiency ^(*)	EFFI	V _{IN} =(V _{OUT(E)} +0.85V)/2, I _{OUT} =100mA, V _{MODE} =0V, V _{FO} :OPEN		93		%	
Lx SW "Pch" ON Resistance	R _{LxP}	I _{OUT} =200mA ^(*)		0.20	0.35 ^(*)	Ω	
Lx SW "Nch" ON Resistance	R _{LxN}	^(*)		0.20 ^(*)	0.35 ^(*)	Ω	
Maximum Current Limit	I _{LIM}	V _{IN} =(V _{OUT(E)} +0.85V)/2	E3			A	
Soft-Start Time	t _{SS}	V _{IN} =V _{PULL} =1.6V, V _{OUT} =V _{OUT(E)} × 0.95 V _{EN} =0V 3.3V, voltage to start oscillation	2.6	5.0	8.5	ms	
Thermal Shut Temperature	T _{TSD}			150			
Hysteresis Width	T _{HYS}			20			
C _L Discharge Resistance XC9136E ^(*)	R _{DCHG}	V _{IN} =V _{OUT} =2.0V ^(*)	100	200	400	Ω	
FO ON Resistance	R _{FO}	V _{EN} =3.3V, V _{FO} =0.5V, V _{OUT(E)} < 3.3V ^(*)	100	200	250	Ω	
		V _{EN} =3.3V, V _{FO} =0.5V, V _{OUT(E)} 3.3V ^(*)		150	200		
FO Leakage Current	I _{FO_LEAK}	V _{FO} =5.5V		0	1	μA	
EN "H" Voltage	V _{ENH}	V _{IN} =V _{PULL} =1.6V, While V _{EN} =0.20V 0.75V, Voltage to start oscillation	0.75		5.5	V	
EN "L" Voltage	V _{ENL}	V _{IN} =V _{PULL} =1.6V, While V _{EN} =0.75V 0.20V, Voltage to stop oscillation	AGND		0.2	V	
MODE "H" Voltage	V _{MODEH}	Voltage for PFM Control R _L is selected with V _{OUT(E)} , Refer to F1 Table	0.75		5.5	V	
MODE "L" Voltage	V _{MODEL}	Voltage for PWM Control R _L is selected with V _{OUT(E)} , Refer to F1 Table	AGND		0.2	V	
EN "H" Current	I _{ENH}	V _{IN} =V _{EN} =5.5V			0.1	μA	
EN "L" Current	I _{ENL}	V _{IN} =5.5V, V _{EN} =0V	-0.1			μA	
MODE "H" Current	I _{MODEH}	V _{IN} =V _{EN} =V _{MODE} =5.5V			0.1	μA	
MODE "L" Current	I _{MODEL}	V _{IN} =V _{EN} =5.5V, V _{MODE} =0V	-0.1			μA	

ELECTRICAL CHARACTERISTICS (Continued)

XC9136E/XC9136N

External Components: $C_{IN}=10\ \mu\text{F}$ (ceramic), $L=2.2\ \mu\text{H}$ (VLCF4020 TDK), $C_{DD}=0.47\ \mu\text{F}$ (ceramic), $C_L=22\ \mu\text{F}$ (ceramic)

Test Conditions

For the Circuit No.1, unless otherwise stated, Circuit No.1 $V_{IN}=1.6\text{V}$, $V_{EN}=V_{MODE}=3.3\text{V}$

For the Circuit No.2, unless otherwise stated, Circuit No.2 $V_{IN}=V_{EN}=V_{OUT(E)} + 0.5\text{V}$, $V_{MODE}=0\text{V}$ (GND connected)

For the Circuit No.3, unless otherwise stated, $V_{OUT}=V_{EN}=V_{MODE}=0\text{V}$ (GND connected)

For the Circuit No.4, unless otherwise stated, $V_{OUT}=V_{EN}=V_{MODE}=0\text{V}$ (GND connected)

For the Circuit No.5, unless otherwise stated, $V_{IN}=V_{PULL}=1.5\text{V}$, $V_{OUT}=V_{EN}=V_{MODE}=V_{FO}=V_{OUT(E)}.0.1\text{V}$

For the Circuit No.6, unless otherwise stated, $V_{OUT}=V_{OUT(E)}+0.5\text{V}$, $V_{EN}=V_{MODE}=0\text{V}$ (GND connected)

For the Circuit No.7, unless otherwise stated, $V_{IN}=V_{OUT(E)}+0.5\text{V}$, $V_{EN}=V_{MODE}=0\text{V}$

For the Circuit No.8, unless otherwise stated, $V_{IN}=V_{LX}=V_{OUT(E)}+0.5\text{V}$, $V_{EN}=V_{MODE}=3.3\text{V}$

For the Circuit No.9, unless otherwise stated, $V_{IN}=1.1\text{V}$, $V_{OUT}=1.6\text{V}$, $V_{EN}=3.3\text{V}$, $V_{MODE}=0\text{V}$ (GND connected)

$V_{OUT(E)}$ = Output Voltage Setting

- (*1) Designed value
- (*2) Efficiency = $\frac{\{(output\ voltage)\ \times\ (output\ current)\}}{\{(input\ voltage)\ \times\ (input\ current)\}} \times 100$
- (*3) L_X SW "P-ch" ON resistance = $(V_{LX}-V_{OUT\ pin\ test\ voltage}) \div 200\text{mA}$
- (*4) Testing method of L_X SW "N-ch" ON resistance is stated at test circuits.
- (*5) C_L Discharge resistance = $V_{OUT} \div V_{OUT\ pin\ measure\ current}$
- (*6) FO ON resistance = $V_{FO} \div FO\ pin\ measure\ current$
- (*7) The XC9136N Series does not have C_L discharge function. For XC9136E.

ELECTRICAL CHARACTERISTICS (Continued)

XC9135L/XC9135M/XC9135R/XC9135T

Ta=25

PARAMETER	SYMBOL	CONDITIONS	MIN	TYP	MAX	UNITS	CIRCUIT
Input Voltage	V _{IN}				5.5	V	
Output Voltage Accuracy ^(*10)	V _{OUT}	V _{IN} =V _{UVLO_R(E)} +0.1V R _L is selected with V _{OUT(E)} , Refer to F1 Table	-2		2	%	
Operation Start Voltage	V _{ST1}	R _L =1kΩ, V _{MODE} =0V			V _{UVLO_R}	V	
		V _{MODE} =0V, V _{UVLO_R(E)} 1.0, V _{OUT(E)} 3.3V, I _{OUT} =100mA V _{OUT(E)} >3.3V, I _{OUT} =50mA			V _{UVLO_R} ^(*1)		
		V _{MODE} =0V, V _{UVLO_R(E)} <1.0, V _{OUT(E)} 3.3V, I _{OUT} =100mA V _{OUT(E)} >3.3V, I _{OUT} =50mA			0.9 ^(*1)		
Operation Hold Voltage	V _{HLD}	R _L =1kΩ, V _{MODE} =0V		V _{UVLO_F}		V	
Current Limit	I _q		E2			μA	
Input Pin Current	I _{BAT}	V _{IN} =V _{OUT(E)} -0.2V, V _{EN} =3.3V		1.1	6.0	μA	
Stand-by Current XC9135L	I _{STB}	V _{IN} =V _{OUT(E)}		0.2	3.5	μA	
Stand-by Current XC9135R				0.2	4.5		
Stand-by Current XC9135M/T				1.0	6.0		
Lx Leakage Current	I _{LxL}	V _{IN} =V _{Lx} =V _{OUT(E)}		0.1	2.0	μA	
Oscillation Frequency	f _{OSC}	V _{IN} =V _{PULL} =(V _{OUT(E)} +V _{UVLO_R(E)})/2	1.02	1.20	1.38	MHz	
Maximum Duty Cycle	D _{MAX}	V _{IN} =V _{PULL} =(V _{OUT(E)} +V _{UVLO_R(E)})/2	86.5	93.0	98.0	%	
Minimum Duty Cycle	D _{MIN}	V _{IN} =V _{OUT(E)} +0.5V R _L is selected with V _{OUT(E)} , Refer to F1 Table			0	%	
PFM Switching Current	I _{PFM}	V _{MODE} =0V, R _L is selected with V _{OUT(E)} , Refer to F1 Table		250	350	mA	
Efficiency ^(*2)	EFFI	I _{OUT} =100mA, V _{MODE} =0V, V _{FO} :OPEN		93		%	
Lx SW "Pch" ON Resistance	R _{LxP}	I _{OUT} =200mA ^(*3)		0.20	0.35 ^(*1)	Ω	
Lx SW "Nch" ON Resistance	R _{LxN}	^(*4)		0.20 ^(*1)	0.35 ^(*1)	Ω	
Maximum Current Limit	I _{LIM}		E3			A	
Integral Latch Time	t _{LAT}	V _{IN} =(V _{OUT(E)})/2, time to stop Lx oscillation from becoming FO="H".	0.5	2.0	4.0	ms	
Soft-Start Time	t _{SS}	V _{IN} =V _{PULL} =(V _{OUT(E)} +V _{UVLO_R(E)})/2, V _{OUT} =V _{OUT(E)} ×0.95 After V _{EN} =0V 3.3V, time to start FO=L.	2.6	5.0	8.5	ms	
Thermal Shut Temperature	T _{TSD}			150			
Hysteresis Width	T _{HYS}			20			
C _L Discharge Resistance XC9135L/R ^(*8)	R _{DCHG}	V _{IN} =V _{OUT} =2.0V ^(*5)	100	200	400	Ω	
FO ON Resistance	R _{FO}	V _{EN} =3.3V, V _{FO} =0.5V, V _{OUT(E)} <3.3V ^(*6)	100	200	250	Ω	
		V _{EN} =3.3V, V _{FO} =0.5V, V _{OUT(E)} 3.3V ^(*6)		150	200		
FO Leakage Current	I _{FO_LEAK}	V _{FO} =5.5V		0	1	μA	

ELECTRICAL CHARACTERISTICS (Continued)

XC9135L/XC9135M/XC9135R/XC9135T

Ta=25

PARAMETER	SYMBOL	CONDITIONS	MIN	TYP	MAX	UNITS	CIRCUIT
EN "H" Voltage	V _{ENH}	V _{IN} =V _{PULL} =(V _{OUT(E)} +V _{UVLO,R(E)})/2, While V _{EN} =0.20V 0.75V, Voltage to start oscillation	0.75		5.5	V	
EN "L" Voltage	V _{ENL}	V _{IN} =V _{PULL} =(V _{OUT(E)} +V _{UVLO,R(E)})/2, While V _{EN} =0.75V 0.20V, Voltage to stop oscillation	AGND		0.2	V	
MODE "H" Voltage	V _{MODEH}	Voltage for PFM Control R _L is selected with V _{OUT(E)} , Refer to F1 Table	0.75		5.5	V	
MODE "L" Voltage	V _{MODEL}	Voltage for PWM Control R _L is selected with V _{OUT(E)} , Refer to F1 Table	AGND		0.2	V	
EN "H" Current	I _{ENH}	V _{IN} =V _{EN} =5.5V			0.1	μA	
EN "L" Current	I _{ENL}	V _{IN} =5.5V, V _{EN} =0V	-0.1			μA	
MODE "H" Current	I _{MODEH}	V _{IN} =V _{EN} =V _{MODE} =5.5V			0.1	μA	
MODE "L" Current	I _{MODEL}	V _{IN} =V _{EN} =5.5V, V _{MODE} =0V	-0.1			μA	
UVLO Release Voltage	V _{UVLO,R}	R _L =1k, While V _{IN} =0.2V 3.3V, Voltage to start oscillation	E4			V	
UVLO Hysteresis Width	V _{UVLO,HYS}	^{(*)7} 0.9 V _{UVLO,R(E)} 2.0 ^{(*)7} 2.0<V _{UVLO,R(E)} 3.0	0.10	0.14	0.20	V	
Output Voltage Drop Protection XC9135R/T ^{(*)9}	V _{LVP}	While V _{OUT} =1.7V 1.3V, Voltage to stop oscillation	1.4	1.5	1.6	V	
UVLO Detect Delay	t _{DF}	After V _{IN} =(V _{OUT(E)} +V _{UVLO,R(E)})/2 0.65V, time to stop oscillation	0.5	1.0	1.5	ms	

External Components: C_{IN}=10 μF(ceramic), L=2.2 μH(VLFC4020 TDK), C_{DD}=0.47 μF(ceramic), C_L=22 μF(ceramic), C_{DF}=1000pF(ceramic)

Test Conditions

For the Circuit No.1, unless otherwise stated, V_{IN}=(V_{OUT(E)}+V_{UVLO,R(E)})/2, V_{EN}=V_{MODE}=V_{FO}=3.3V

For the Circuit No.2, unless otherwise stated, V_{IN}=V_{EN}=V_{OUT(E)} + 0.5V, V_{MODE}=0V(GND connected), C_{DF}:OPEN

For the Circuit No.3, unless otherwise stated, V_{OUT}=V_{EN}=V_{MODE}=0V(GND connected), C_{DF}:OPEN

For the Circuit No.4, unless otherwise stated, V_{OUT}=V_{EN}=V_{MODE}=0V(GND connected), C_{DF}:OPEN

For the Circuit No.5, unless otherwise stated, V_{IN}=V_{PULL}=1.5V, V_{OUT}=V_{EN}=V_{MODE}=V_{FO}=V_{OUT(E)}.0.1V,

For the Circuit No.6, unless otherwise stated, V_{OUT}=V_{OUT(E)}+0.5V, V_{EN}=V_{MODE}=0V(GND connected), C_{DF}:OPEN

For the Circuit No.7, unless otherwise stated, V_{IN}=V_{OUT(E)}+0.5V, V_{EN}=V_{MODE}=0V(GND connected), C_{DF}:OPEN

For the Circuit No.8, unless otherwise stated, V_{IN}=V_{LX}=V_{OUT(E)}+0.5V, V_{EN}=V_{MODE}=3.3V, C_{DF}:OPEN

For the Circuit No.9, unless otherwise stated, V_{IN}=1.1V, V_{OUT}=1.6V, V_{EN}=3.3V, V_{MODE}=V_{FB}(C_{DF})=0V(GND connected)

V_{OUT(E)}= Output Voltage Setting

V_{UVLO,R(E)}=UVLO Voltage Setting

V_{UVLO,F}=V_{UVLO,R}-V_{UVLO,HYS}

(*1) Designed value

(*2) Efficiency = [(output voltage) X (output current)] ÷ [(input voltage) X (input current)] X 100

(*3) L_X SW "P-ch" ON resistance=(V_{LX}-V_{OUT} pin test voltage)÷200mA

(*4) Testing method of L_X SW "N-ch" ON resistance is stated at test circuits.

(*5) C_L Discharge resistance = V_{OUT} ÷ V_{OUT} pin measure current

(*6) FO ON resistance = V_{FO} ÷ FO pin measure current

(*7) The Voltage is a difference between V_{UVLO,R} and the voltage to stop oscillation for L_Xpin while V_{IN}=V_{UVLO,R} 0.2V.R_L=1k

(*8) The XC9135M, XC9135T series does not have C_L discharge function. For XC9135L, XC9135R.

(*9) The XC9135L, XC9135M series does not have output voltage drop protection. For XC9135R, XC9135T.

XC9135/XC9136 Series Voltage Chart

SYMBOL	E1		E2		E3		
PARAMETER	Output Voltage Error margin		Supply Current		Maximum Current Limit		
V	V		μA		A		
Output voltage	MIN	MAX	TYP	MAX	MIN	TYP	MAX
1.8 [*]	1.764	1.836	35	50		0.98	1.85
1.9 [*]	1.862	1.938	36	50		1.03	1.85
2.0 [*]	1.960	2.040	36	50		1.09	1.85
2.1 [*]	2.058	2.142	36	50		1.14	1.85
2.2 [*]	2.156	2.244	36	50		1.18	1.85
2.3 [*]	2.254	2.346	36	50		1.23	1.85
2.4 [*]	2.352	2.448	36	50		1.27	1.85
2.5 [*]	2.450	2.550	36	50		1.31	1.85
2.6 [*]	2.548	2.652	36	50		1.34	1.85
2.7 [*]	2.646	2.754	36	50		1.37	1.85
2.8	2.744	2.856	37	50		1.40	1.85
2.9	2.842	2.958	37	50		1.42	1.85
3.0	2.940	3.060	37	50	1.15	1.45	1.85
3.1	3.038	3.162	37	51	1.17	1.47	1.85
3.2	3.136	3.264	37	51	1.18	1.49	1.87
3.3	3.234	3.366	37	52	1.19	1.50	1.89
3.4	3.332	3.468	37	52	1.21	1.52	1.91
3.5	3.430	3.570	37	52	1.22	1.53	1.92
3.6	3.528	3.672	37	53	1.22	1.54	1.94
3.7	3.626	3.774	38	53	1.23	1.55	1.95
3.8	3.724	3.876	38	54	1.24	1.56	1.96
3.9	3.822	3.978	38	54	1.25	1.57	1.97
4.0	3.920	4.080	38	54	1.25	1.57	1.97
4.1	4.018	4.182	38	55	1.26	1.58	1.99
4.2	4.116	4.284	38	55	1.26	1.58	1.99
4.3	4.214	4.386	38	56	1.26	1.58	1.99
4.4	4.312	4.488	38	56	1.26	1.58	1.99
4.5	4.410	4.590	39	56	1.26	1.59	2.00
4.6	4.508	4.692	39	57	1.26	1.59	2.00
4.7	4.606	4.794	39	57	1.26	1.59	2.00
4.8	4.704	4.896	39	58	1.26	1.59	2.00
4.9	4.802	4.998	39	58	1.26	1.59	2.00
5.0	4.900	5.100	39	58	1.26	1.59	2.00

^{*} XC9135A/XC9135C/XC9135L/XC9135M series are excluded.

When output voltage is lower than 2.9V, maximum current limit may happen to decrease.

Please refer to the typical performance characteristics

graph #10 of Maximum Current Limit vs. Ambient Temperature

$V_{OUT(E)}$	R_L
V	Ω
1.8 $V_{OUT(E)} < 2.1$	150
2.1 $V_{OUT(E)} < 3.1$	220
3.1 $V_{OUT(E)} < 4.3$	330
4.3 $V_{OUT(E)} \leq 5$	470

SYMBOL	E4	
PARAMETER	UVLO Release Voltage Accuracy	
V	%	
UVLO	MIN	MAX
0.9 $V_{UVLO_R} < 1.0$	-4.5	4.5
1.0 $V_{UVLO_R} < 1.7$	-3.0	3.0
1.7 $V_{UVLO_R} < 2.3$	-3.5	3.5
2.3 $V_{UVLO_R} < 3.0$	-4.5	4.5
3.0 = V_{UVLO_R}	-5.5	5.5

TYPICAL APPLICATION CIRCUIT

XC9135 Series

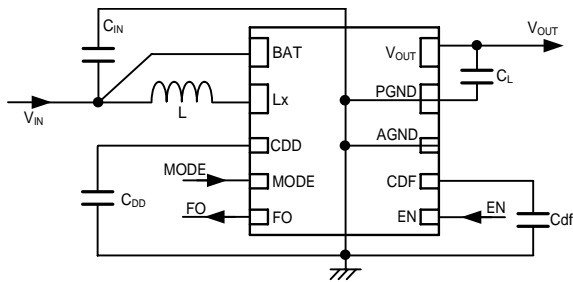

XC9136 Series

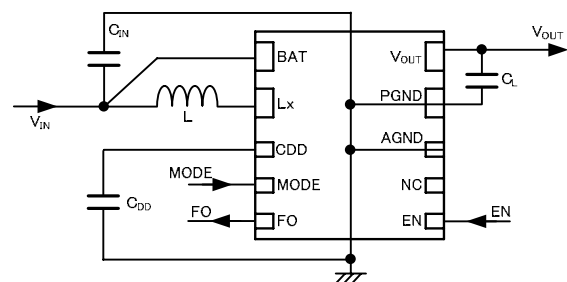

<CDF pin settings, XC9135 series>

A capacitor can be connected to the CDF pin to set the delay time for stopping operation after UVLO is detected. The length of the delay time depends on the capacitance of the Cdf capacitor. Use a capacitor with a capacitance of 1000pF or higher for the Cdf capacitor.

The relationship between the capacitance of the Cdf capacitor and the delay time is 1 ms of delay for each 1000pF (3000pF gives a delay of 3ms).

[External Components]

$f_{osc}=1.2\text{MHz}$

L: $2.2\ \mu\text{H} \sim 4.7\ \mu\text{H}$

VLCF4020 series, LTF5022-LC series

C_L : Should be selected in $20\ \mu\text{F}$ or higher

Capacitor JMK212BJ106KG $\times 2$, LMK212BJ106KG $\times 2$, LMK316BJ226ML is recommended.

Ceramic capacitor: B (JIS standard) or X7R, X5R (EIA standard)

C_{IN} : $10\ \mu\text{F}$

Capacitor JMK212BJ106KG or LMK212BJ106KG is recommended.

Ceramic capacitor: B (JIS standard) or X7R, X5R (EIA standard)

C_{DD} : $0.47\ \mu\text{F}$ (Ceramic capacitor)

C_{DF} : 1000pF

* UVLO detect delay capacitor C_{DF} and C_{DD} is constantly applied in the same voltage to V_{DD} . While selecting a part, please concern about capacitance reduction and voltage durability.

* For the coil L, please use $2.2\ \mu\text{H}$ to $4.7\ \mu\text{H}$. However, when the input voltage V_{IN} is lower than 1.5V, please use $2.2\ \mu\text{H}$.

* Capacitance C_L is recommended $20\ \mu\text{F}$ or higher. (Ceramic capacitor compatible)

When you select the external components, please consider capacitance loss and voltage durability.

* If using tantalum or low ESR electrolytic capacitors please be aware that ripple voltage will be higher due to the larger ESR (Equivalent Series Resistance) values of those types of capacitors. Please also note that the IC's operation may become unstable with such capacitors so that we recommend to test on the board before usage.

* If using electrolytic capacitor for the C_L , please connect a ceramic capacitor in parallel.

OPERATIONAL EXPLANATION (Continued)

The XC9135/XC9136 series consists of a reference voltage source, ramp wave circuit, error amplifier, PWM comparator, phase compensation circuit, N-channel driver transistor, P-channel synchronous rectification switching transistor and current limiter circuit.

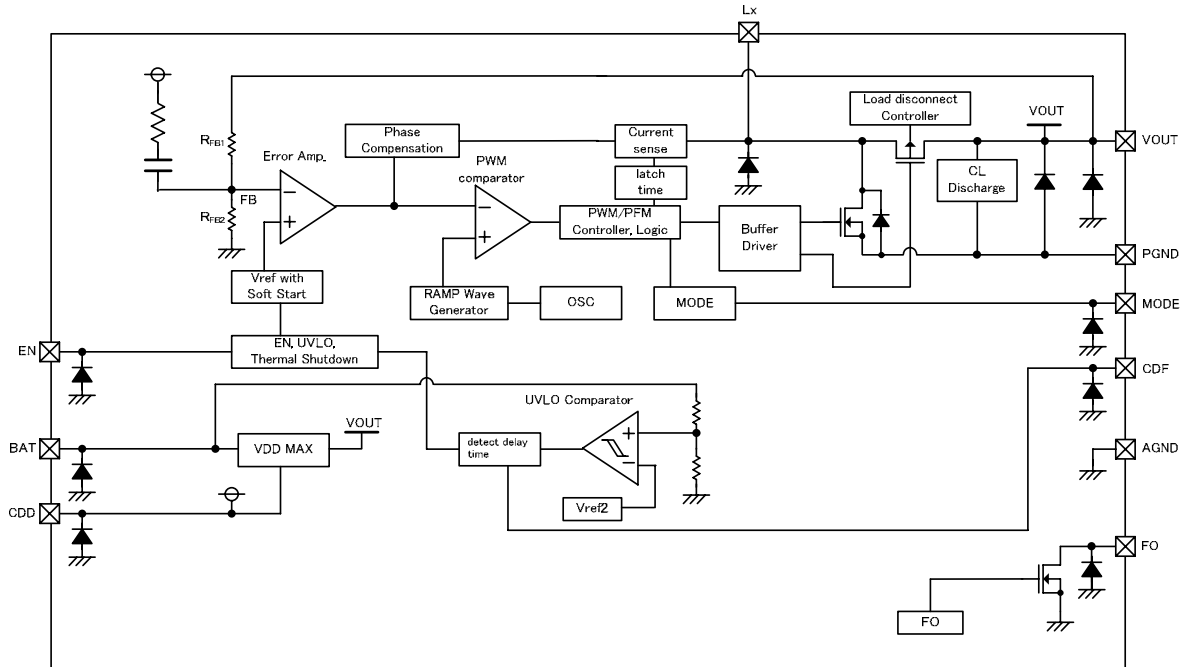

The error amplifier compares the internal reference voltage with the resistors RFB1 and RFB2. Phase compensation is performed on the resulting error amplifier output, to input a signal to the PWM comparator to determine the turn-on time of the N-channel driver transistor during PWM operation. The PWM comparator compares, in terms of voltage level, the signal from the error amplifier with the ramp wave from the ramp wave circuit, and delivers the resulting output to the buffer driver circuit to cause the Lx pin to output a switching duty cycle. This process is continuously performed to ensure stable output voltage. The current feedback circuit monitors the N-channel driver transistor's turn-on current for each switching operation, and modulates the error amplifier output signal to provide multiple feedback signals. This enables a stable feedback loop even when a low ESR capacitor, such as a ceramic capacitor, is used, ensuring stable output voltage.

<Reference Voltage Source>

The source provides the reference voltage to ensure stable output of the DC/DC converter.

<Ramp Wave Circuit>

The ramp wave circuit determines switching frequency. The frequency is fixed internally at 1.2MHz. The Clock generated is used to produce ramp waveforms needed for PWM operation, and to synchronize all the internal circuits.

<Error Amplifier>

The error amplifier is designed to monitor output voltage. The amplifier compares the reference voltage with the feedback voltage divided by the internal resistors (RFB1 and RFB2). When the FB pin is lower than the reference voltage, output voltage of the error amplifier increases. The gain and frequency characteristics of the error amplifier are optimized internally.

OPERATIONAL EXPLANATION (Continued)

< Maximum Current Limit >

The current limiter circuit monitors the maximum current flowing through the N-channel driver transistor connected to the Lx pin, and features a combination of the current limit and latch function.

When the driver current is greater than a specific level (equivalent to peak coil current), the maximum current limit function starts to operate and the pulses from the Lx pin turn off the N-channel driver transistor at any given time.

When the driver transistor is turned off, the limiter circuit is then released from the maximum current limit detection state.

At the next pulse, the driver transistor is turned on. However, the transistor is immediately turned off in the case of an over current state.

When the over current state is eliminated, the IC resumes its normal operation.

The XC9135 series waits for the over current state to end by repeating the steps through . If an over current state continues for several milliseconds and the above three steps are repeatedly performed, the IC performs the function of latching the OFF state of the N-channel driver transistor and P-channel synchronous transistor, and goes into operation suspension mode. After being put into suspension mode, the IC can resume operation by turning itself off once and then re-starting via the EN pin, or by restoring power to the VIN pin.

The XC9136 series does not have this latch function, so operation steps through repeat until the over current state ends. Integral latch time may be released from an over current detection state because of the noise. Depending on the state of a substrate, it may result in the case where the latch time may become longer or the operation may not be latched. Please locate an input capacitor as close as possible.

Please note that the current flow into the N-channel driver transistor is different from output current I_{OUT} .

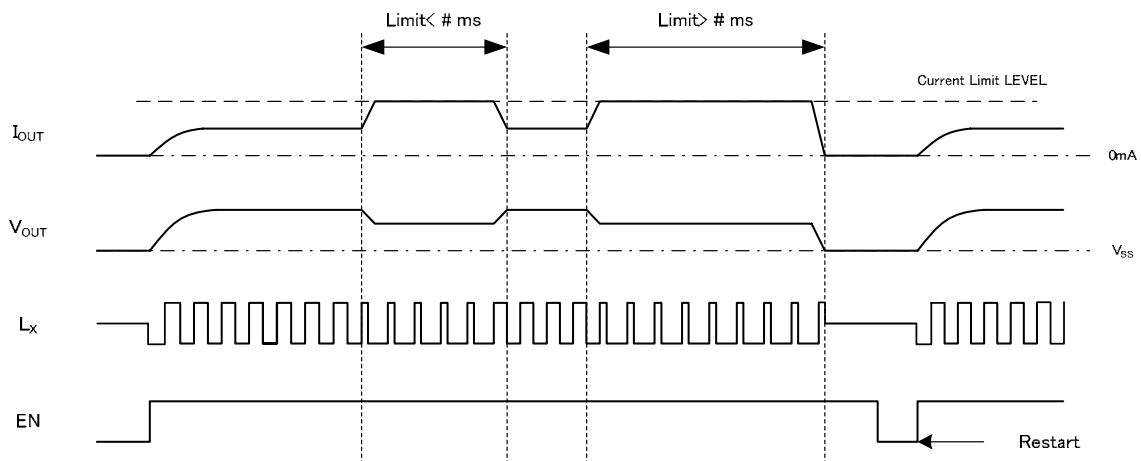

<Thermal Shutdown>

For protection against heat damage, the thermal shutdown function monitors chip temperature. When the chip's temperature reaches 150°C (TYP.), the thermal shutdown circuit starts operating and the driver transistor will be turned off. At the same time, the output voltage decreases. When the temperature drops to 130°C (TYP.) after shutting off the current flow, the IC performs the soft start function to initiate output startup operation.

<MODE>

The MODE pin operates in PWM mode by applying a high level voltage and in PFM/PWM automatic switching mode by applying a low level voltage.

<Shut-Down, Load Disconnection Function>

The IC enters chip disable state by applying low level voltage to the EN pin. At this time, the N-channel and P-channel synchronous switching transistors are turned OFF. Please also note that a parasitic diode of the P-channel synchronous switch is controlled, thus, the current conduction path is disconnected.

<Flag Out>

The FO pin becomes high impedance during over current state, over temperature state, soft-start period, and shut-down period. In normal state, the FO pin is low impedance. The FO pin is N-channel open drain output.

OPERATIONAL EXPLANATION (Continued)

<CL Discharge >

The XC9135A/XC9135B/XC9135L/XC9135R/XC9136E series can discharge the electric charge at the output capacitor (C_L) when a low signal to the EN pin which enables a whole IC circuit put into OFF state, is inputted via the N-channel transistor located between the V_{OUT} pin and the PGND pin. When the IC is disabled, electric charge at the output capacitor (C_L) is quickly discharged so that it may avoid application malfunction. Discharge time of the output capacitor (C_L) is set by the C_L auto-discharge resistance (R) and the output capacitor (C_L). By setting time constant of a C_L auto-discharge resistance value [R_{DCHG}] and an output capacitor value (C_L) as ($\tau = C \times R$), discharge time of the output voltage after discharge via the N channel transistor is calculated by the following formulas. However, the C_L discharge resistance [R_{DCHG}] is depends on the V_{BAT} or V_{OUT} , so it is difficult to make sure the discharge time. We recommend that you fully check actual performance.

$$V = V_{OUT} \times e^{-t / \tau} \quad \text{or} \quad t = \tau \ln(V_{OUT}/V)$$

- V : Output voltage after discharge
- V_{OUT} : Output voltage
- t : Discharge time
- τ : $C \times R$
- C : Capacitance of Output capacitor (C_L)
- R : C_L Discharge resistance, it depends on supply voltage

Output Voltage Discharge Characteristics

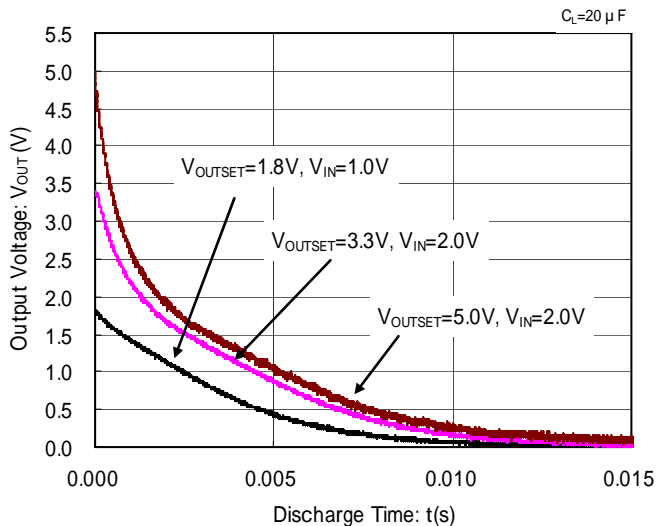

The XC9135C/XC9135K/XC9135M/XC9135T/XC9136N series do not have CL discharge function. If the MODE pin is set low to select auto PWM/PFM mode, the output of XC9135C/XC9135K/XC9135M/XC9135T/XC9136N series can be connected to another power supply. However, it should be noted that when the output of XC9135A/XC9135B/XC9135L/XC9135R/XC9136E series is connected to another power supply, the IC may be damaged.

< C_{DD} , V_{DDMAX} >

V_{DDMAX} circuit compares the input voltage and the output voltage then it will select the higher one as the power supply for the IC. The higher voltage will be supplied to the C_{DD} pin and the IC operates in stable when a capacitor is connected.

<UVLO>

The XC9135 Series has a UVLO function. When the voltage of the BAT pin falls below V_{UVLO_F} , the IC stops oscillating. When the voltage of the BAT pin rises above V_{UVLO_R} , output restarts by soft-start.

<UVLO Detect Delay Time>

On the XC9135 Series, a capacitor C_{df} can be connected to the CDF pin to set the delay time for stopping operation after UVLO is detected.

This will prevent malfunctioning of the UVLO function due to temporary drops in the BAT voltage caused by load transients and other conditions.

If the BAT voltage falls below the UVLO detection voltage and then returns to the UVLO release voltage or higher within the detection delay time, the IC will continue operating.

If the BAT voltage does not return to the UVLO release voltage or higher within the detection delay time, the IC will stop oscillating after the detection delay time has elapsed.

<Output Voltage Drop Protection>

The XC9135B/ XC9135K/ XC9135R/ XC9135T Series has a built-in output voltage drop protection function.

If the output voltage V_{OUT} falls below the output voltage drop protection voltage V_{LVP} due to an overload or other condition, the

function will latch the Nch driver Tr and the Pch synchronous rectification switch Tr in the off state. Once in the latched state, operation is restarted by turning the IC off and then on with the EN pin, or by restarting the power.

NOTE ON USE

1. Please do not exceed the stated absolute maximum ratings values.
2. The DC/DC converter performance is greatly influenced by not only the ICs' characteristics, but also by those of the external components. Care must be taken when selecting the external components. Especially for C_L load capacitor, it is recommended to use type B capacitors (JIS regulation) or X7R, X5R capacitors (EIA regulation).
3. Make sure that the PCB GND traces are as thick and wide as possible. The ground voltage fluctuation caused by high ground current at the time of switching may result in instability of the IC. Therefore, the GND traces close to PGND pin and AGND pin are important.
4. Please mount each external component as close to the IC as possible. Also, please make traces thick and short to reduce the circuit impedance.
5. When the device is used in high step-up ratio, the current limit function may not work during excessive load current. In this case, the maximum duty cycle limits maximum current. For the XC9135 series, while the current is controlled with maximum duty cycle, over current latch function will not work.
6. In case of connecting to another power supply as shown in below circuit diagram, please use the XC9135C/XC9135K/XC9135M/XC9135T/XC9136N series. Please also note that the MODE pin is fixed in low level for selecting PWM/PFM auto mode. If the MODE pin is in high to maintain fixed PWM control mode, the backflow current may happen. If the output of XC9135A/XC9135B/XC9135L/XC9135R/XC9136E series is connected to another power supply, the IC may be damaged.

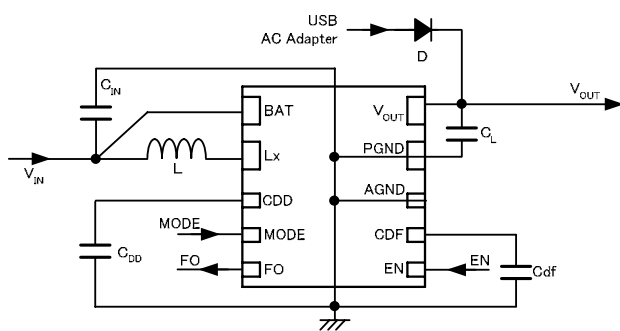

7. The maximum current limiter controls the limit of the N-channel driver transistor by monitoring current flow. This function does not limit the current flow of the P-channel synchronous transistor. When over current flows to the P-channel synchronous transistor in case of load, the IC may be damaged.
8. The integral latch time of the XC9135 series could be released from the maximum current detection state as a result of board mounting conditions. This may extend integral latch time or the level required for latch operation to function may not be reached. Please connect the output capacitor as close to the IC as possible.
9. The MODE pin and EN pin are not pulled-down internally. Please make sure that the voltage applied to the MODE pin and the EN pin.
10. When used in small step-up ratios, the device may skip pulses during PWM control mode.
11. In the PWM/PFM auto, transition from PFM to PWM mode, or PWM to PFM mode, the output voltage may be fluctuated. (Please refer below)

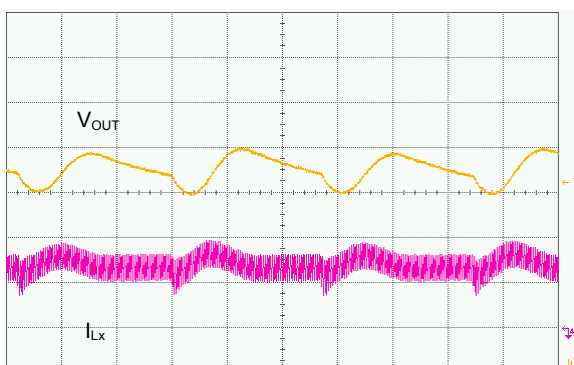

$V_{IN}=4.2V$, $V_{OUT}=5.0V$, MODE: Auto PWM/PFM
 $V_{OUT}:50mV/div$, $I_{Lx}:200mA/div$, Time:20 $\mu s/div$
 $L=4.7 \mu H$ (LTF5022-LC), $C_L=20 \mu F$ (LMK212BJ106KG*2)
 $C_{IN}=10 \mu F$ (LMK212BJ106KG), $C_{DD}=0.47 \mu F$ (EMK107BJ474KA-T)
 $R_{FB1}=270k\Omega$, $R_{FB2}=30k\Omega$, $C_{FB}=10pF$

NOTE ON USE (Continued)

12. When used in large step-up ratios and small load current, the output voltage may change when PWM/PFM auto is changed to PWM control mode by using the MODE pin. (Please refer below)

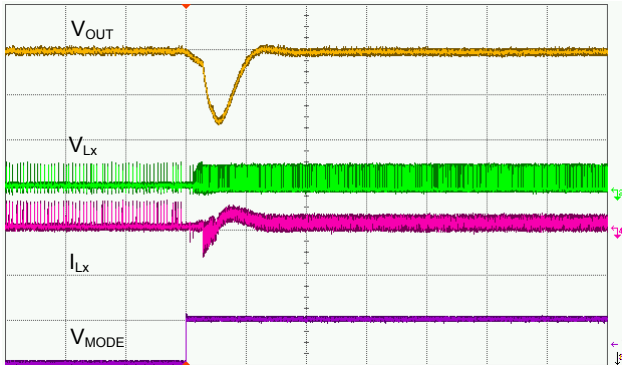

$V_{IN}=0.9V$, $V_{OUT}=5.0V$, MODE:PWM/PFM→PWM, $I_{OUT}=3mA$
 V_{OUT} :100mV/div, I_{Lx} :500mA/div, V_{Lx} :10V/div, V_{MODE} :5V/div, Time:200 μ s/div
 $L=2.2 \mu$ H(VLCF4020), $C_L=20 \mu$ F(LMK212BJ106KG*2)
 $C_{IN}=10 \mu$ F(LMK212BJ106KG), $C_{DD}=0.47 \mu$ F(EMK107BJ474KA-T)
 $R_{FB1}=270k\Omega$, $R_{FB2}=30k\Omega$, $C_{FB}=0pF$

13. After the soft-start period, when used in $V_{IN} > V_{OUTSET}$ (the input voltage is higher than the output voltage), In the XC9135C/ XC9135K/ XC9135M/XC9135T/XC9136N series, the P-channel synchronous transistor is turned on when MODE pin is tied to high. When the MODE pin is tied to low, the current flows into the parasitic diode of the P-channel synchronous transistor so that results in generating excessive heat in the IC. Please test in the board before usage with considering heat dissipation. For the XC9135A /XC9135B/XC9135L/XC9135R/XC9136E, series (under development) the P-channel synchronous transistor is always turned on which is no matter of MODE pin control.
14. During start-up, when output setting voltage is lower than 2V, the PWM/PFM auto mode should be selected. In case of the fixed PWM control mode, the output voltage may become smaller than the setting voltage. When the setting output voltage is higher than 2V, the IC can be started to operate in the both modes of PWM/PFM auto and fixed PWM control.
15. For temporary, transitional voltage drop or voltage rising phenomenon, the IC is liable to malfunction should the ratings be exceeded.
16. Torex places an importance on improving our products and its reliability. However, by any possibility, we would request user fail-safe design and post-aging treatment on system or equipment.

NOTE ON USE (Continued)

Instructions for pattern layouts

1. In order to stabilize V_{IN} voltage level, we recommend that a by-pass capacitor C_{IN} is connected as close as possible to the V_{IN} and V_{SS} pins.
2. Please mount each external component as close to the IC as possible.
3. Place external components as close to the IC as possible and use thick and short traces to reduce the circuit impedance.
4. Make sure that the PCB GND traces are thick and wide as possible. Ground voltage level fluctuation created by high ground current at the time of switching may cause instability of the IC.
5. The internal driver transistors bring on heat because of the I_{IN} current and ON resistance of the driver transistors.
6. Please place a capacitor between CDF pin and GND.

Example of pattern layout

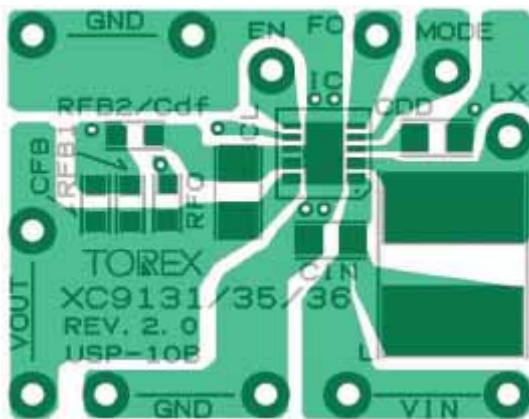

FRONT

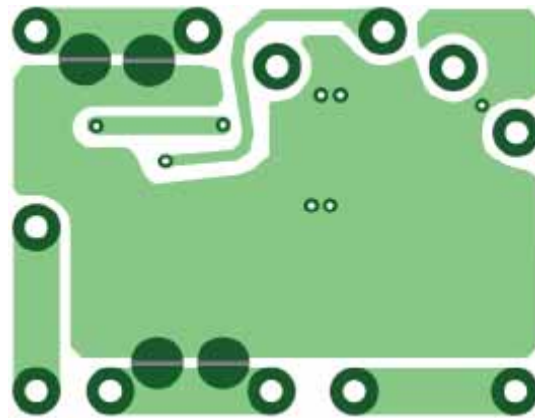

BACK

TEST CIRCUITS

<Circuit No.1>

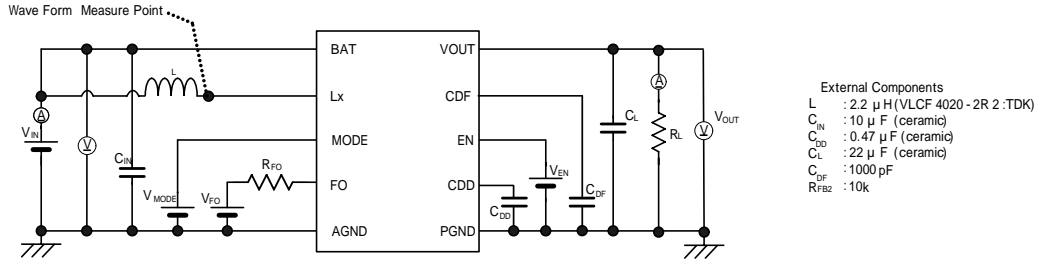

<Circuit No.2 >

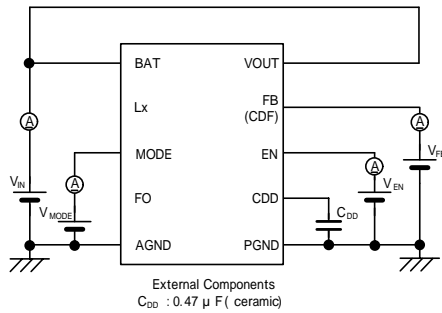

<Circuit No.3 >

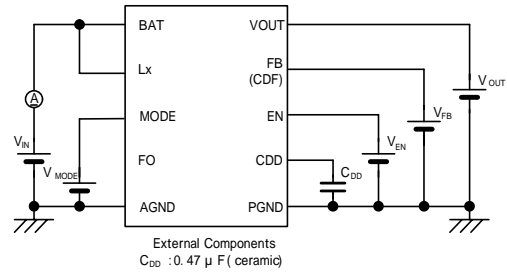

< Circuit No.4 >

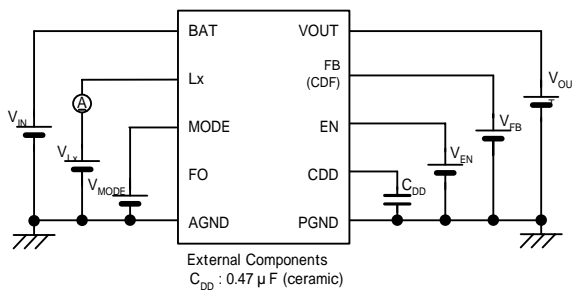

TEST CIRCUITS(Continued)

<Circuit No.5>

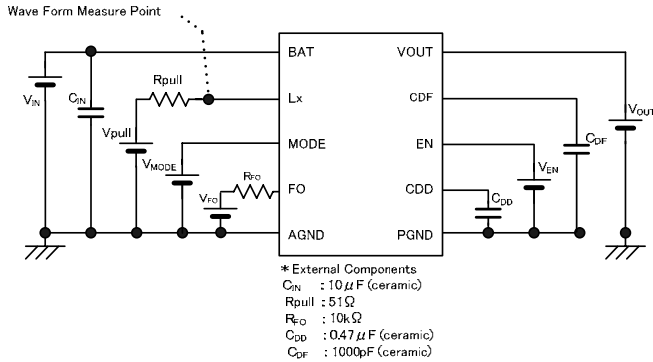

< Circuit No.6>

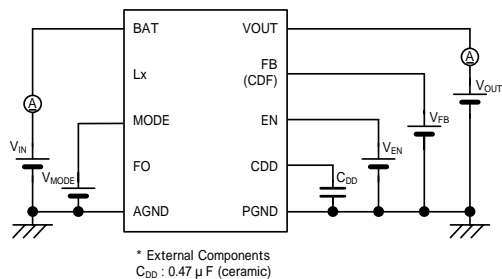

<Circuit No.7 >

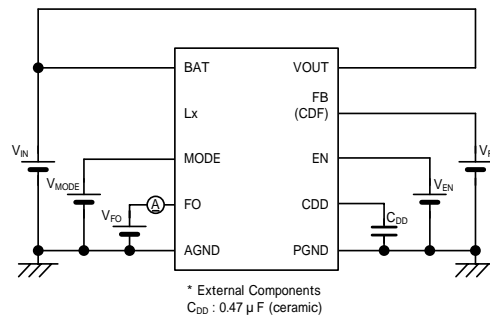

<Circuit No.8 >

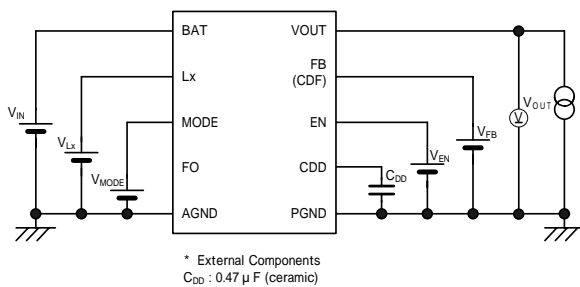

<Circuit No.9 >

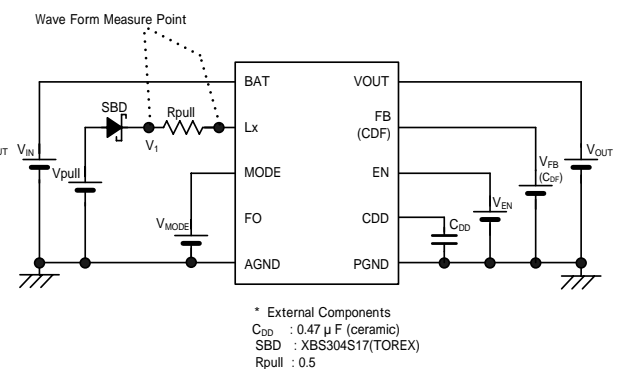

Circuit No.1 ~ 9

XC9136E/XC9136N series does not have FB (CDF) pin.

<Measurement method for ON resistance of the Lx switch>

Using the layout of circuit No.9 above, set the L_x pin voltage to 50mV by adjusting the V_{pull} voltage whilst the N-channel driver transistor is turned on. Then, measure the voltage difference between both ends of R_{pull}. ON Resistance is calculated by using the following formula: (However, when the XC9135 series is measured, CDF pin is grounded, please start measurement on operation under $V_{UVLO_R} < V_{IN}$)

$$R_{LXN} = 0.05 \div ((V_1 - 0.05) \div 0.5)$$

where V₁ is a node voltage between SBD and R_{pull}. L_x pin voltage and V₁ are measured by an oscilloscope.

TYPICAL PERFORMANCE CHARACTERISTICS

(1) Efficiency vs. Output Current

XC9135C32CDR-G ($V_{OUT}=3.2V$)

$L=4.7\ \mu H$ (VLF3014ST-4R7M1R1), $C_L=22\ \mu F$ (LMK316ABJ226ML)
 $C_{IN}=10\ \mu F$ (JMK212ABJ106KG), $C_{DD}=0.47\ \mu F$ (TMK107BJ474KA)
 $f_{OSC}=1.2MHz$

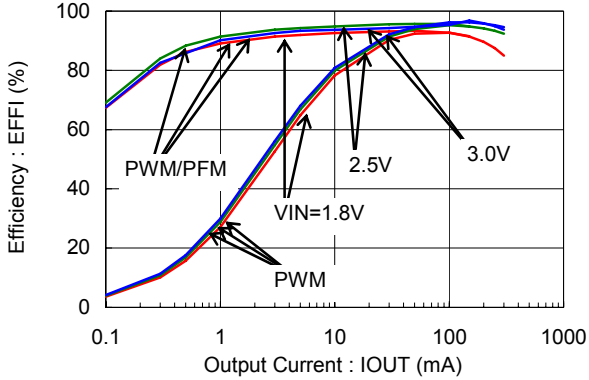

XC9136E32CDR-G ($V_{OUT}=3.2V$)

$L=2.2\ \mu H$ (LTF5022-2R2-LC), $C_L=22\ \mu F$ (LMK316ABJ226ML)
 $C_{IN}=10\ \mu F$ (LMK212ABJ106KG), $C_{DD}=0.47\ \mu F$ (EMK107BJ474KA)
 $f_{OSC}=1.2MHz$

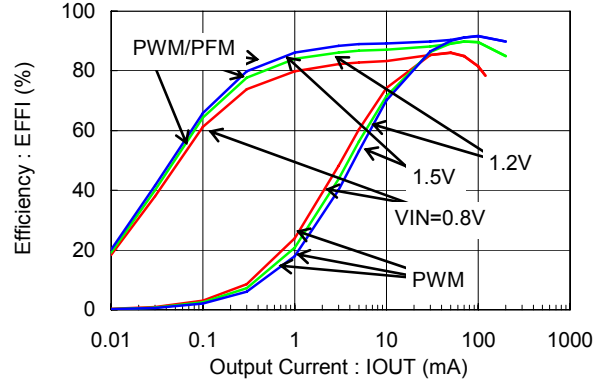

XC9136E50CDR-G ($V_{OUT}=5V$)

$L=4.7\ \mu H$ (VLF5010S-4R7), $C_L=22\ \mu F$ (LMK316ABJ226ML)
 $C_{IN}=10\ \mu F$ (LMK212ABJ106KG), $C_{DD}=0.47\ \mu F$ (TMK107BJ474KA)
 $f_{OSC}=1.2MHz$

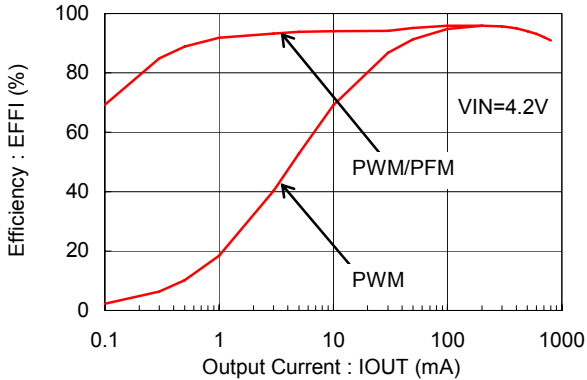

(2) Output Voltage vs. Output Current

XC9135C32CDR-G ($V_{OUT}=3.2V$)

$L=4.7\ \mu H$ (VLF3014ST-4R7M1R1), $C_L=22\ \mu F$ (LMK316ABJ226ML)
 $C_{IN}=10\ \mu F$ (JMK212ABJ106KG), $C_{DD}=0.47\ \mu F$ (TMK107BJ474KA)
 $f_{OSC}=1.2MHz$

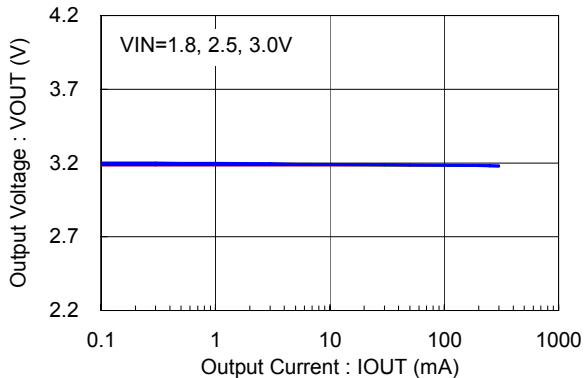

XC9136E32CDR-G ($V_{OUT}=3.2V$)

$L=2.2\ \mu H$ (LTF5022-2R2-LC), $C_L=22\ \mu F$ (LMK316ABJ226ML)
 $C_{IN}=10\ \mu F$ (LMK212ABJ106KG), $C_{DD}=0.47\ \mu F$ (EMK107BJ474KA)
 $f_{OSC}=1.2MHz$

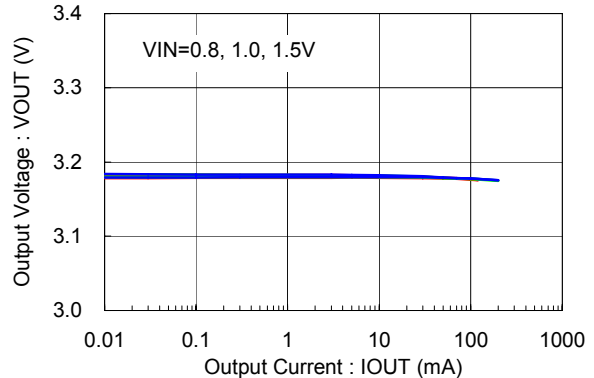

TYPICAL PERFORMANCE CHARACTERISTICS

(2) Output Voltage vs. Output Current (Continued)

XC9136E50CDR-G ($V_{OUT}=5V$)

$L=4.7\ \mu\text{H}$ (VLF5010S-4R7), $C_L=22\ \mu\text{F}$ (LMK316ABJ226ML)
 $C_{IN}=10\ \mu\text{F}$ (LMK212ABJ106KG), $C_{DD}=0.47\ \mu\text{F}$ (TMK107BJ474KA)
 $f_{OSC}=1.2\text{MHz}$

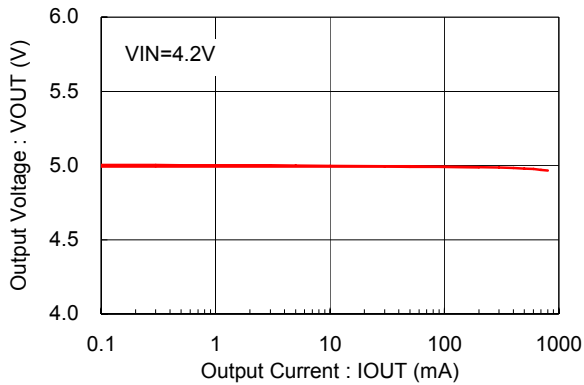

(3) Ripple Voltage vs. Output Current

XC9135C32CDR-G ($V_{OUT}=3.2V$)

$L=4.7\ \mu\text{H}$ (VLF3014ST-4R7M1R1), $C_L=22\ \mu\text{F}$ (LMK316ABJ226ML)
 $C_{IN}=10\ \mu\text{F}$ (JMK212ABJ106KG), $C_{DD}=0.47\ \mu\text{F}$ (TMK107BJ474KA)
 $f_{OSC}=1.2\text{MHz}$

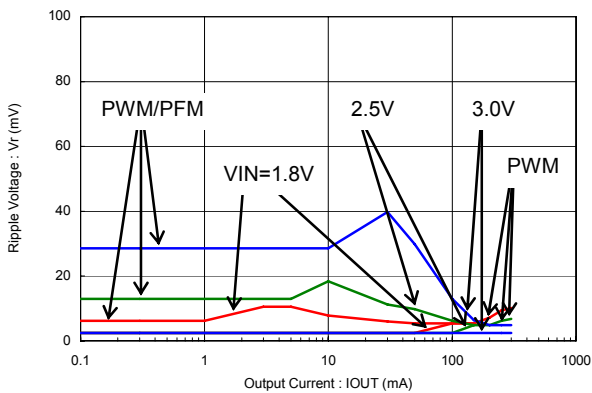

XC9136E32CDR-G ($V_{OUT}=3.2V$)

$L=2.2\ \mu\text{H}$ (LTF5022-2R2-LC), $C_L=22\ \mu\text{F}$ (LMK316ABJ226ML)
 $C_{IN}=10\ \mu\text{F}$ (LMK212ABJ106KG), $C_{DD}=0.47\ \mu\text{F}$ (EMK107BJ474KA)
 $f_{OSC}=1.2\text{MHz}$

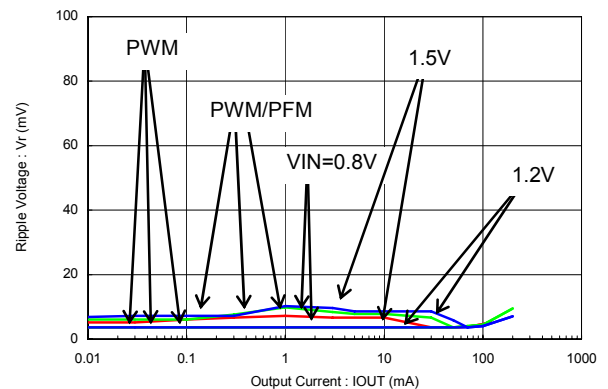

XC9136E50CDR-G ($V_{OUT}=5V$)

$L=4.7\ \mu\text{H}$ (VLF5010S-4R7), $C_L=22\ \mu\text{F}$ (LMK316ABJ226ML)
 $C_{IN}=10\ \mu\text{F}$ (LMK212ABJ106KG), $C_{DD}=0.47\ \mu\text{F}$ (TMK107BJ474KA)
 $f_{OSC}=1.2\text{MHz}$

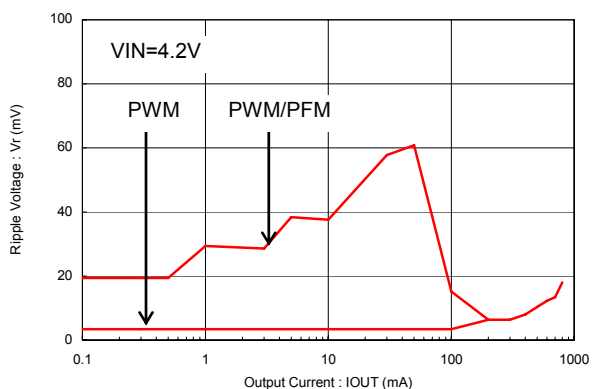

TYPICAL PERFORMANCE CHARACTERISTICS (Continued)

(4) Output Voltage vs. Ambient Temperature

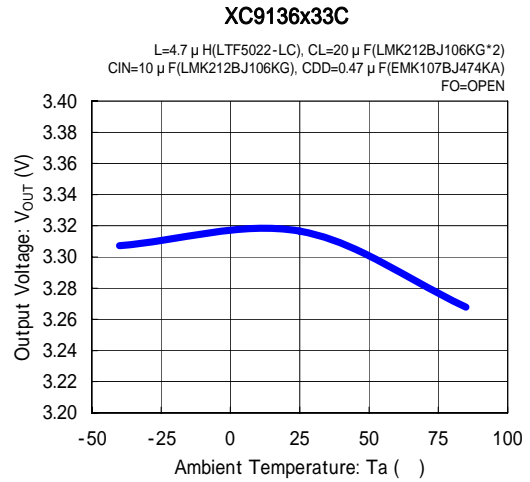
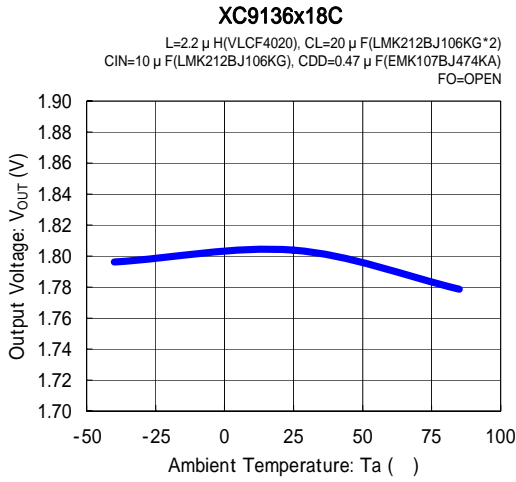

(5) Supply Current vs. Ambient Temperature

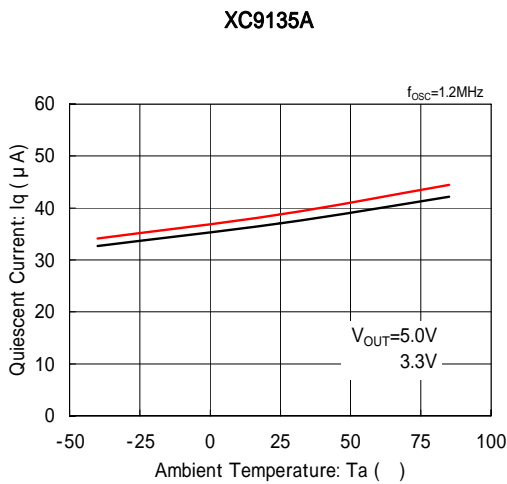

(6) Stand-by Current vs. Ambient Temperature

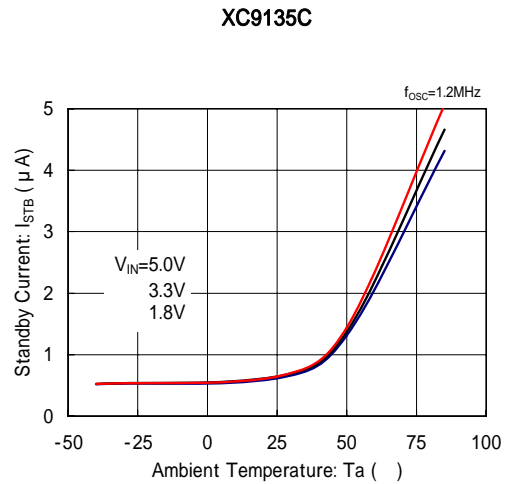
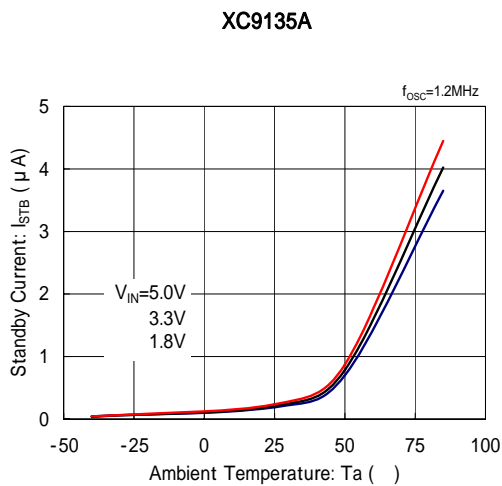

TYPICAL PERFORMANCE CHARACTERISTICS (Continued)

(7) Oscillation Frequency vs. Ambient Temperature

XC9135/XC9136

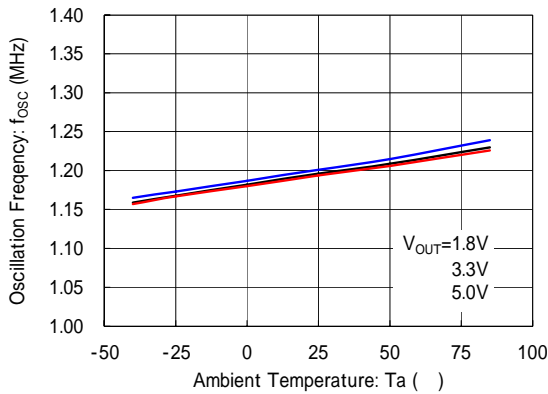

(8) Maximum Duty Cycle vs. Ambient Temperature

XC9135/XC9136

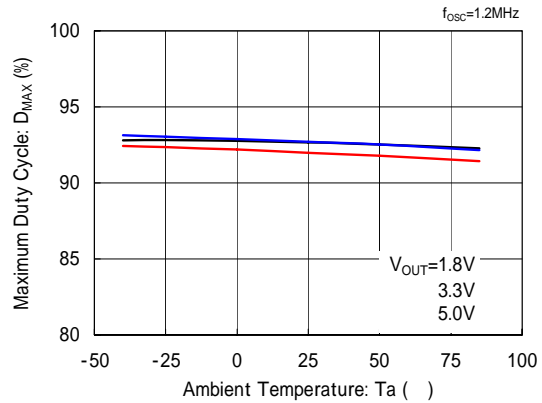

(9) Lx SW "N-ch" ON Resistance vs. Output Voltage

XC9135/XC9136

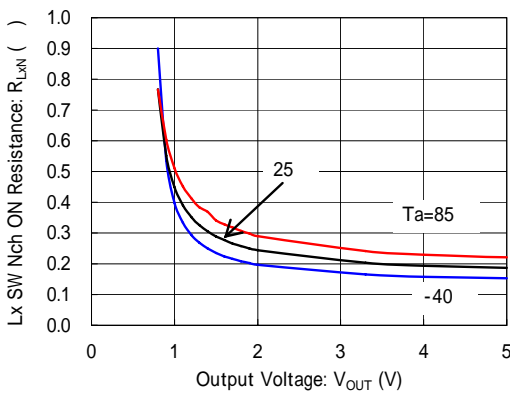

(10) Lx SW "P-ch" ON Resistance vs. Ambient Temperature

XC9135/XC9136

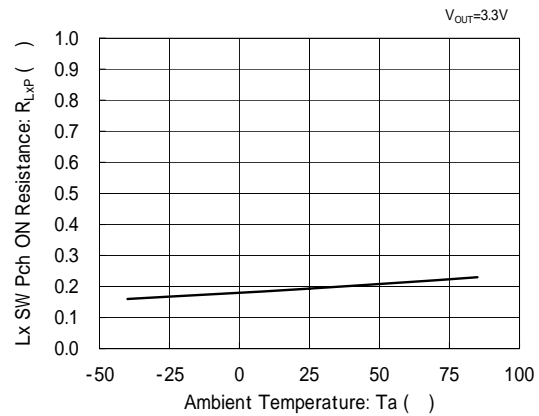

(11) Lx Leakage Current vs. Ambient Temperature

XC9135/XC9136

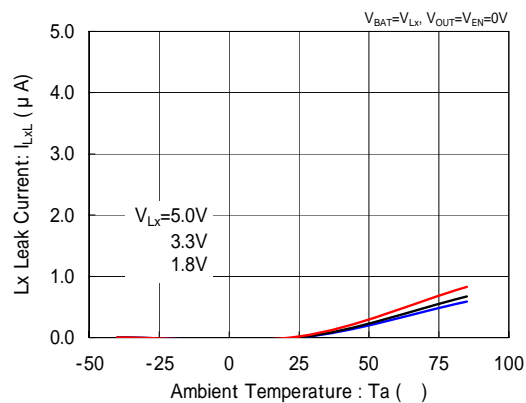

(12) Soft-Start Time vs. Ambient Temperature

XC9135/XC9136

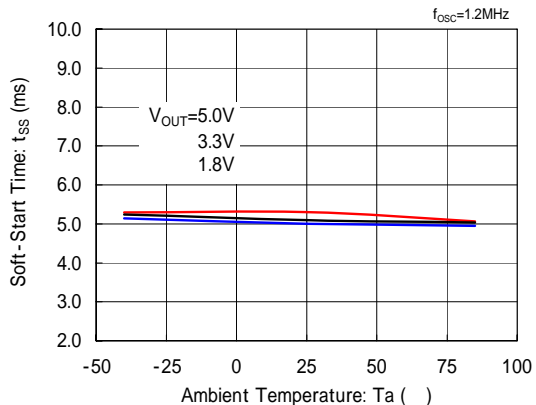

TYPICAL PERFORMANCE CHARACTERISTICS (Continued)

(13) PFM Switch Current vs. Input Voltage

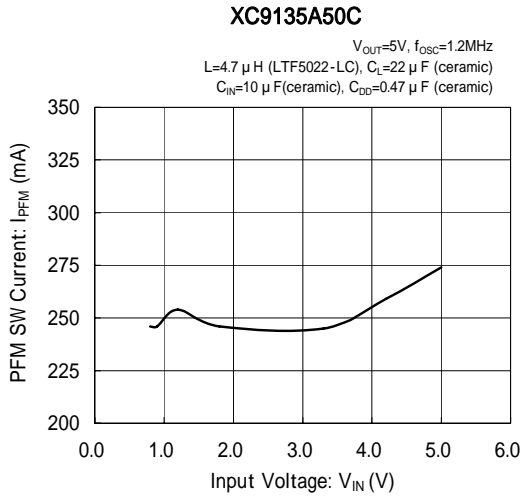

(14) MODE "H", "L" Voltage vs. Output Voltage

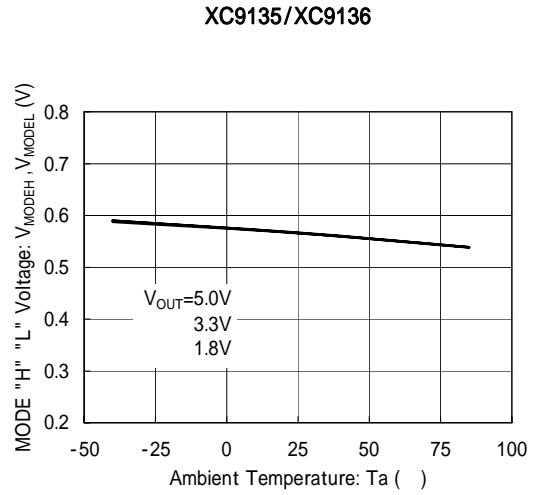

(15) EN "H" Voltage vs. Output Voltage

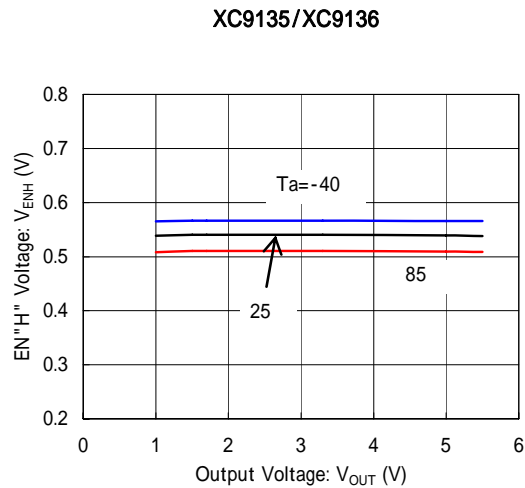

(16) EN "L" Voltage vs. Output Voltage

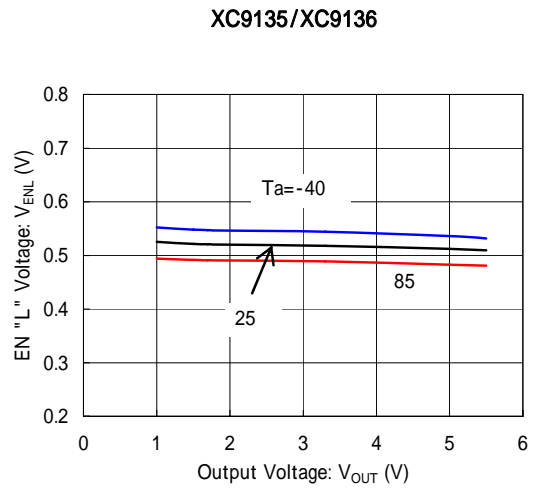

(17) Operation Start Voltage vs. Ambient Temperature

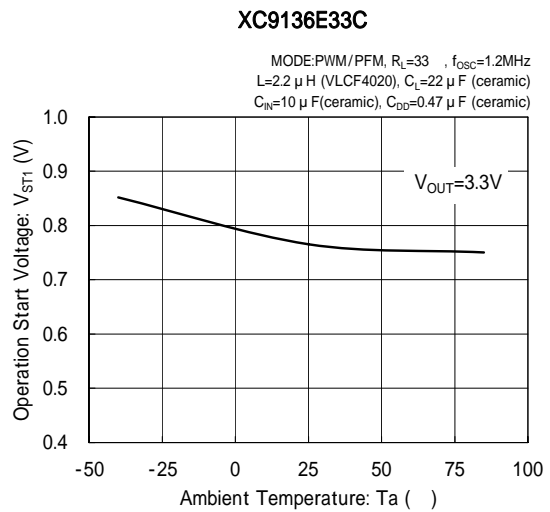
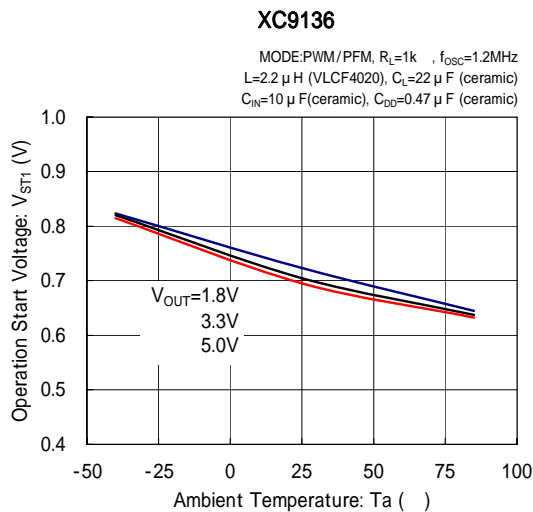

TYPICAL PERFORMANCE CHARACTERISTICS (Continued)

(18) Operation Hold Voltage vs. Ambient Temperature

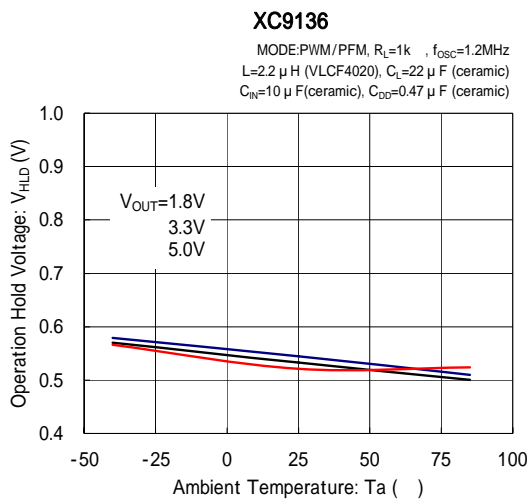

(19) No Load Input Current vs. Input Voltage

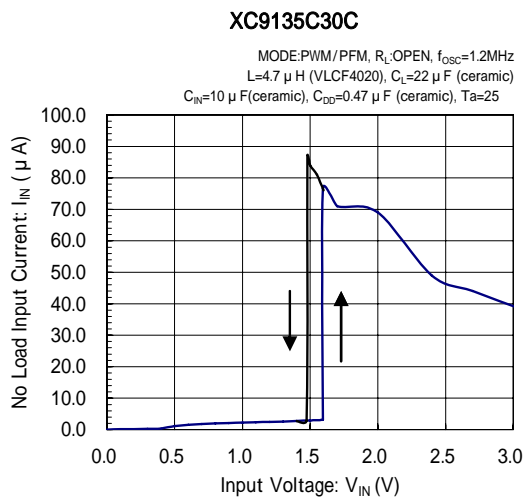

(20) Current Limit vs. Ambient Temperature

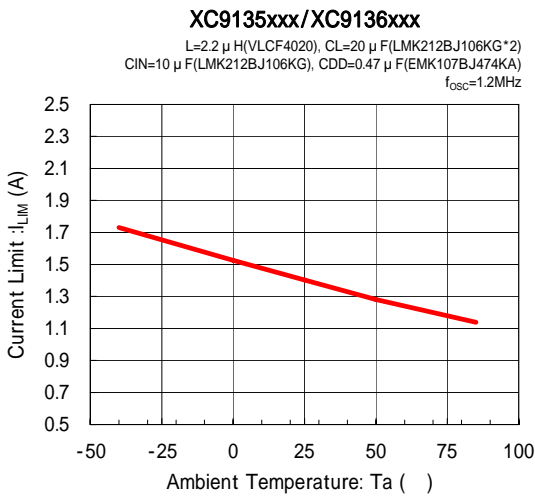

(21) Latch Time vs. Ambient Temperature

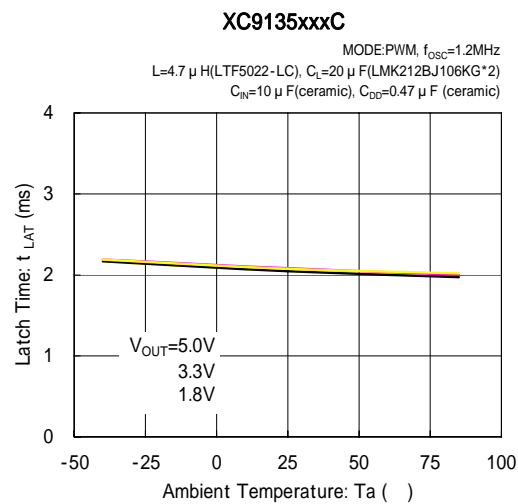

(22) UVLO Release Voltage vs. Ambient Temperature

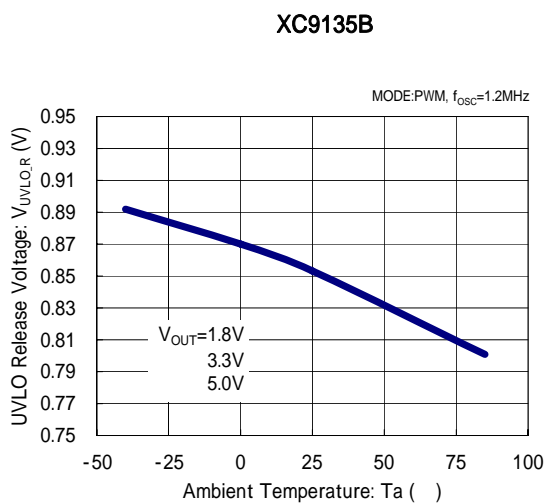
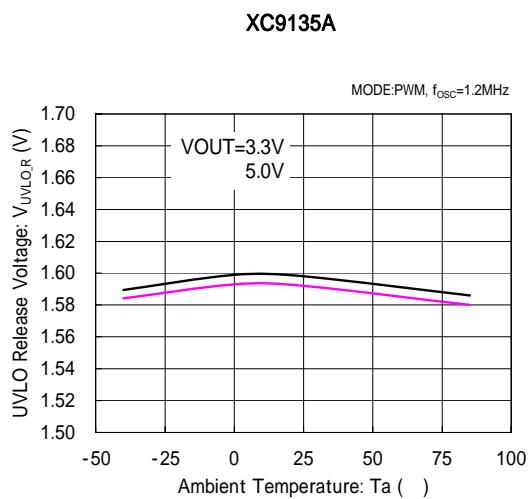

TYPICAL PERFORMANCE CHARACTERISTICS (Continued)

(23) UVLO Release Voltage vs. Ambient Temperature

XC9135A

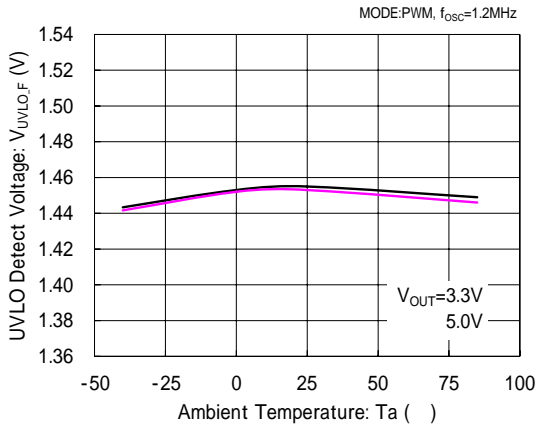

XC9135B

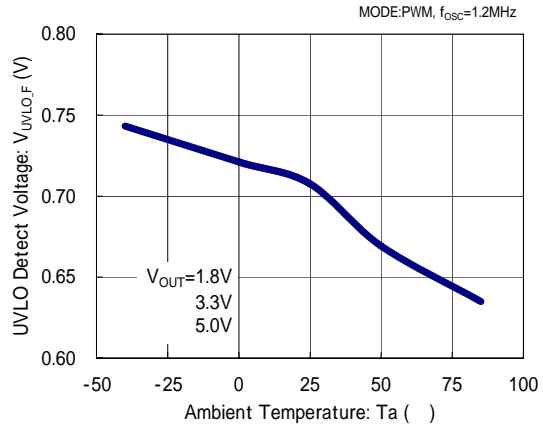

(24) UVLO Hysteresis Voltage vs. Ambient Temperature

XC9135BxxC/XC9135KxxC

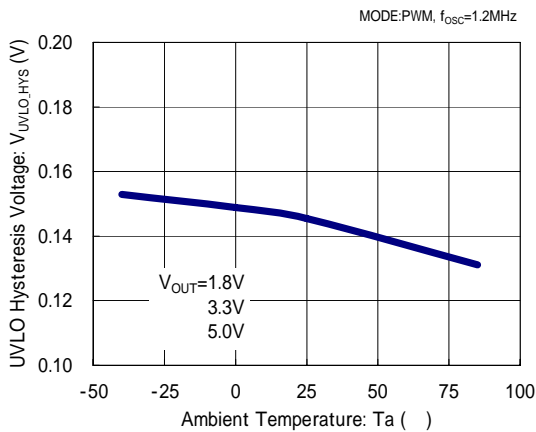

(25) UVLO Detect Delay Time vs. Ambient Temperature

XC9135AxxC/XC9135CxxC

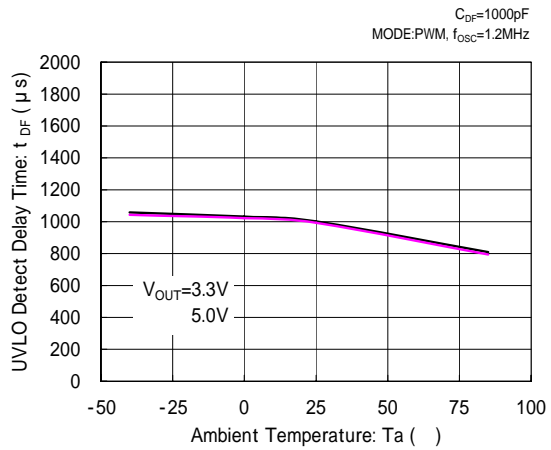

(26) Quiescent Current vs. UVLO Voltage

XC9135C

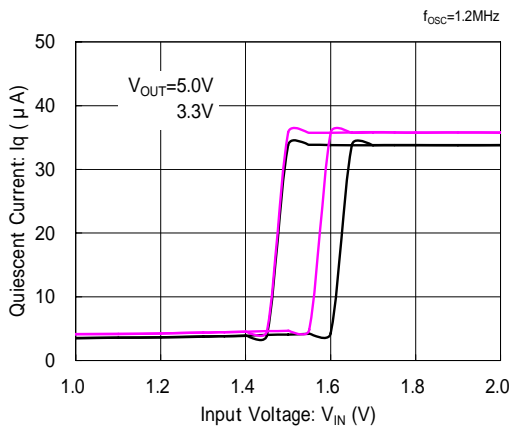

(27) Low Voltage Protection Voltage vs. Ambient Temperature

XC9135K

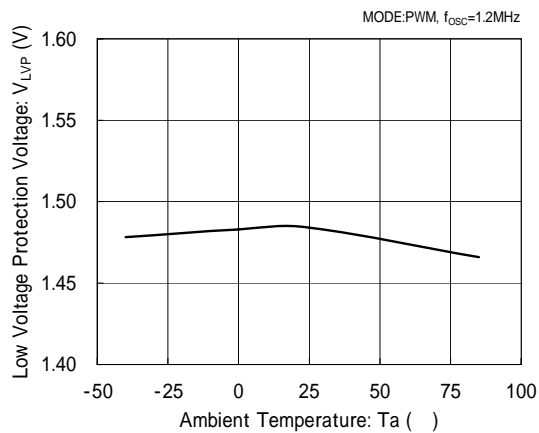

TYPICAL PERFORMANCE CHARACTERISTICS (Continued)

(28) FO ON Resistance vs. Ambient Temperature

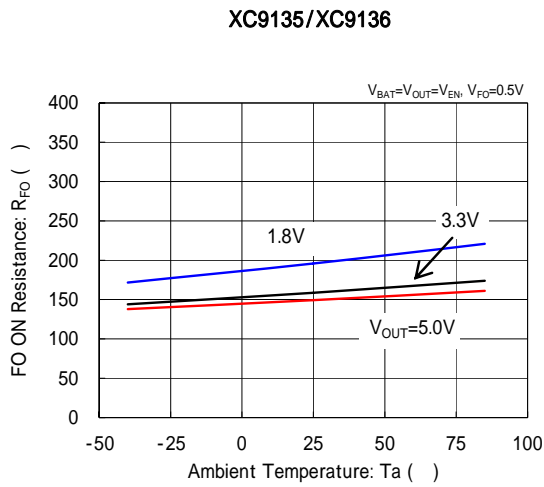

(29) C_L Discharge Resistance vs. Ambient Temperature

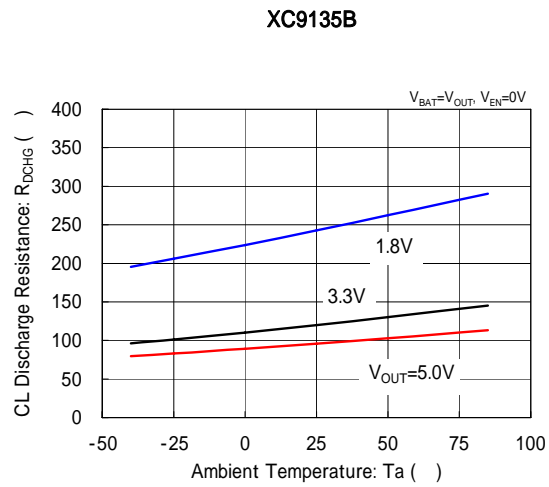

(30) Soft-start

$V_{OUT}=3.3V, V_{IN}=1.8V, R_L=33\ \Omega$, MODE:PWM/PFM

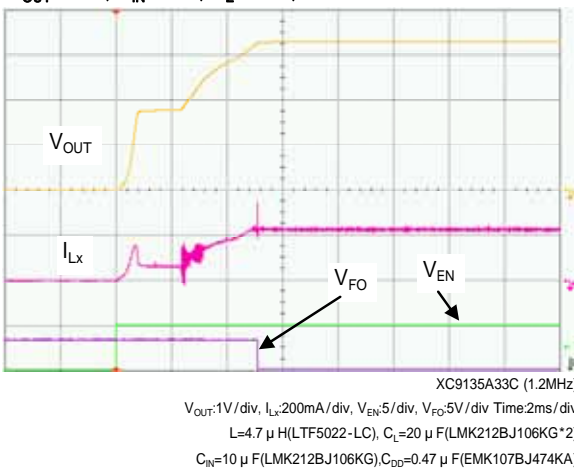

$V_{OUT}=5.0V, V_{IN}=5.5V, R_L=50\ \Omega$

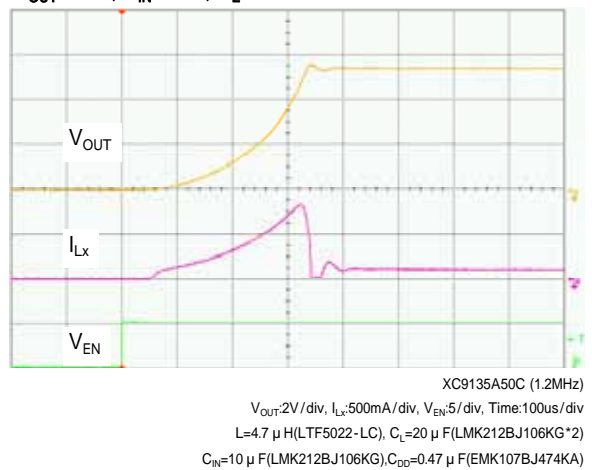

$V_{OUT}=2.0V, V_{IN}=0.9V, R_L=20\ \Omega$, MODE:PWM/PFM

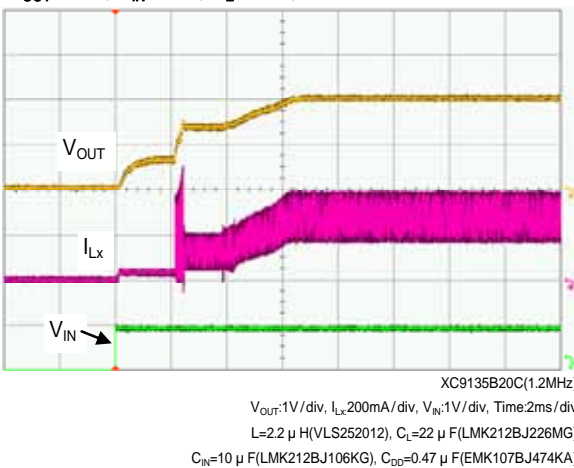

TYPICAL PERFORMANCE CHARACTERISTICS (Continued)

Load Transient Response

$V_{OUT}=1.8V$, $V_{IN}=0.9V$, $I_{OUT}=1mA$ 50mA

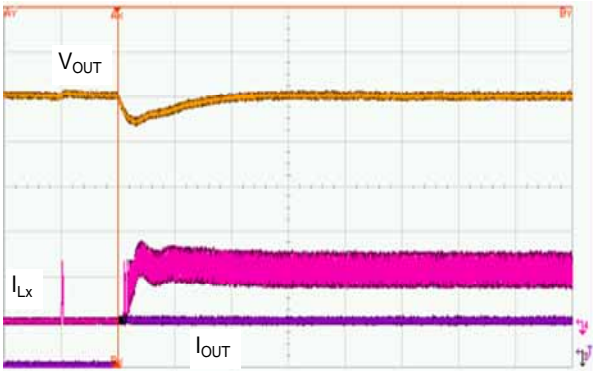

XC9136E18C (1.2MHz, PWM/PFM)
 V_{OUT} :100mV/div, I_{LX} :200mA/div, I_{OUT} :50mA/div, Time:50 μ s/div
 $L=2.2 \mu$ H(LTF5022-LC), $C_L=20 \mu$ F(LMK212BJ106KG*2)
 $C_{IN}=10 \mu$ F(LMK212BJ106KG), $C_{DD}=0.47 \mu$ F(EMK107BJ474KA)

$V_{OUT}=1.8V$, $V_{IN}=0.9V$, $I_{OUT}=50mA$ 1mA

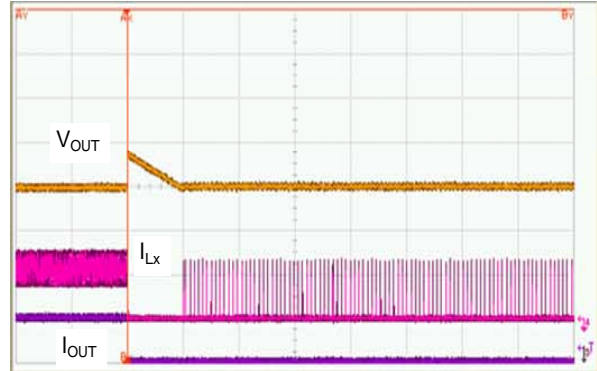

XC9136E18C (1.2MHz, PWM/PFM)
 V_{OUT} :100mV/div, I_{LX} :200mA/div, I_{OUT} :50mA/div, Time:1ms/div
 $L=2.2 \mu$ H(LTF5022-LC), $C_L=20 \mu$ F(LMK212BJ106KG*2)
 $C_{IN}=10 \mu$ F(LMK212BJ106KG), $C_{DD}=0.47 \mu$ F(EMK107BJ474KA)

$V_{OUT}=3.3V$, $V_{IN}=1.8V$, $I_{OUT}=1mA$ 200mA

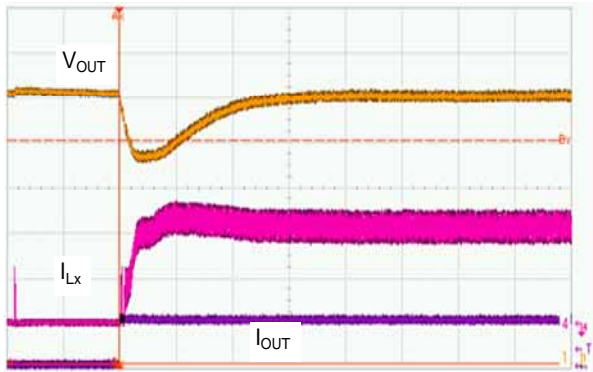

XC9136E33C (1.2MHz, PWM/PFM)
 V_{OUT} :100mV/div, I_{LX} :200mA/div, I_{OUT} :200mA/div, Time:50 μ s/div
 $L=4.7 \mu$ H(LTF5022-LC), $C_L=20 \mu$ F(LMK212BJ106KG*2)
 $C_{IN}=10 \mu$ F(LMK212BJ106KG), $C_{DD}=0.47 \mu$ F(EMK107BJ474KA)

$V_{OUT}=3.3V$, $V_{IN}=1.8V$, $I_{OUT}=200mA$ 1mA

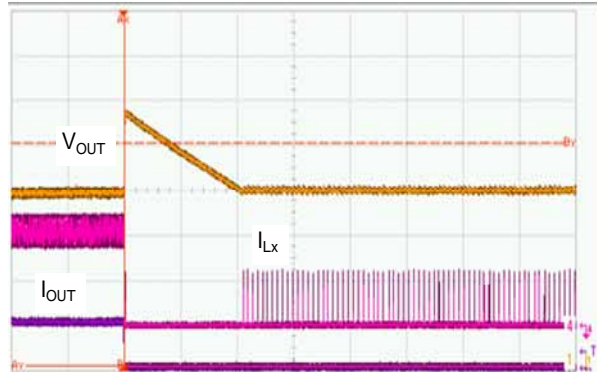

XC9136E33C (1.2MHz, PWM/PFM)
 V_{OUT} :100mV/div, I_{LX} :200mA/div, I_{OUT} :200mA/div, Time:1ms/div
 $L=4.7 \mu$ H(LTF5022-LC), $C_L=20 \mu$ F(LMK212BJ106KG*2)
 $C_{IN}=10 \mu$ F(LMK212BJ106KG), $C_{DD}=0.47 \mu$ F(EMK107BJ474KA)

$V_{OUT}=3.3V$, $V_{IN}=1.8V$, $I_{OUT}=1mA$ 200mA

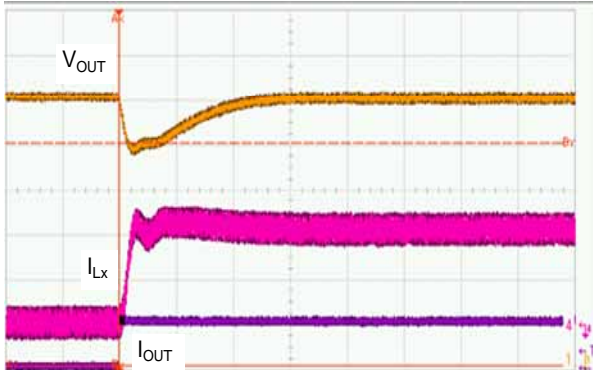

XC9136E33C (1.2MHz, PWM)
 V_{OUT} :100mV/div, I_{LX} :200mA/div, I_{OUT} :200mA/div, Time:50 μ s/div
 $L=4.7 \mu$ H(LTF5022-LC), $C_L=20 \mu$ F(LMK212BJ106KG*2)
 $C_{IN}=10 \mu$ F(LMK212BJ106KG), $C_{DD}=0.47 \mu$ F(EMK107BJ474KA)

$V_{OUT}=3.3V$, $V_{IN}=1.8V$, $I_{OUT}=200mA$ 1mA

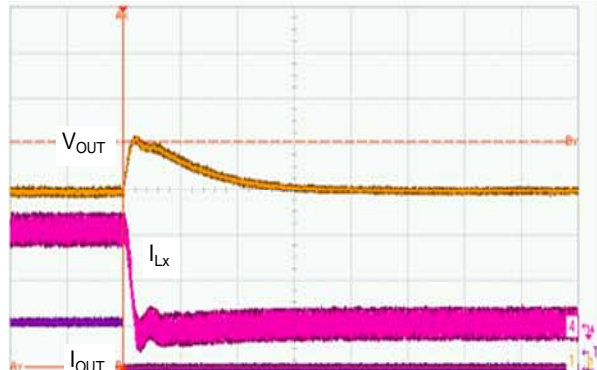

XC9136E33C (1.2MHz, PWM)
 V_{OUT} :100mV/div, I_{LX} :200mA/div, I_{OUT} :200mA/div, Time:50 μ s/div
 $L=4.7 \mu$ H(LTF5022-LC), $C_L=20 \mu$ F(LMK212BJ106KG*2)
 $C_{IN}=10 \mu$ F(LMK212BJ106KG), $C_{DD}=0.47 \mu$ F(EMK107BJ474KA)

TYPICAL PERFORMANCE CHARACTERISTICS (Continued)

Load Transient Response (Continued)

$V_{OUT}=5.0V$, $V_{IN}=3.7V$, $I_{OUT}=1mA$ 250mA

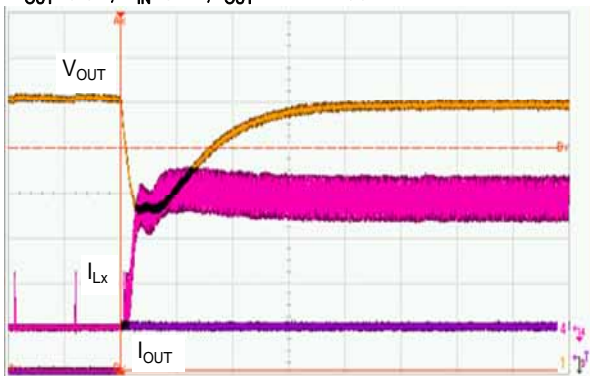

XC9136E50C(1.2MHz,PWM/PFM)
 V_{OUT} :100mV/div, I_{LX} :200mA/div, I_{OUT} :250mA/div, Time:50 μ s/div
 $L=4.7 \mu$ H(LTF5022-LC), $C_L=20 \mu$ F(LMK212BJ106KG*2)
 $C_{IN}=10 \mu$ F(LMK212BJ106KG), $C_{DD}=0.47 \mu$ F(EMK107BJ474KA)

$V_{OUT}=5.0V$, $V_{IN}=3.7V$, $I_{OUT}=250mA$ 1mA

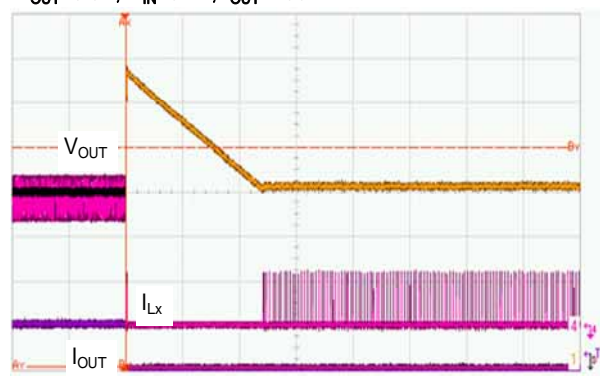

XC9136E50C(1.2MHz,PWM/PFM)
 V_{OUT} :100mV/div, I_{LX} :200mA/div, I_{OUT} :250mA/div, Time:1ms/div
 $L=4.7 \mu$ H(LTF5022-LC), $C_L=20 \mu$ F(LMK212BJ106KG*2)
 $C_{IN}=10 \mu$ F(LMK212BJ106KG), $C_{DD}=0.47 \mu$ F(EMK107BJ474KA)

PACKAGING INFORMATION

USP-10B

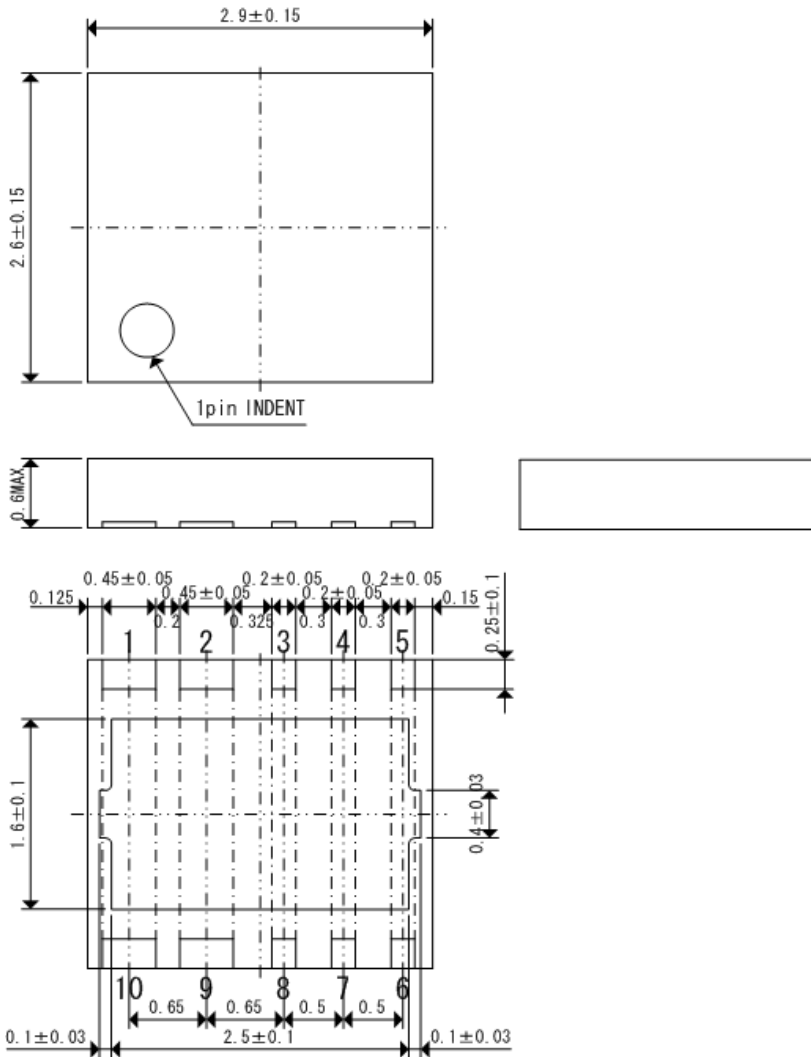

PACKAGING INFORMATION (Continued)

USP-10B Reference Pattern Layout

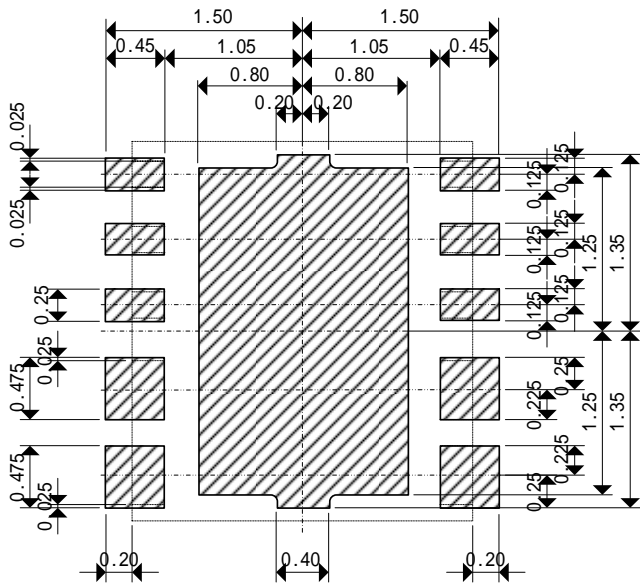

USP-10B Reference Metal Mask Design

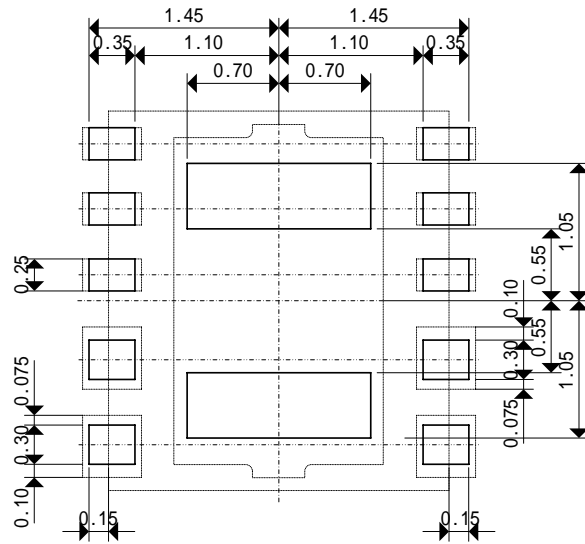

MARKING RULE

USP-10B

represents product series

MARK	PRODUCT SERIES
5	XC9135*****-G
6	XC9136*****-G

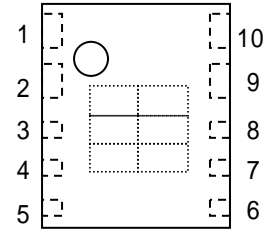

USP-10B
(TOP VIEW)

represents a type of DC/DC converters

MARK	ITEM	DESCRIPTION ⁽²⁾ (...With the functions) x ...Without the functions)					PRODUCT SERIES
		UVLO 0.85V	UVLO 1.6V	UVLO DETECT DELAY	LATCH PROTECTION	C _L AUTO DISCHARGE ⁽³⁾	
A	Output voltage internally set-up(V _{OUT})	x					XC9135A****-G
C	Output voltage internally set-up(V _{OUT})	x				x	XC9135C****-G
B	Output voltage internally set-up(V _{OUT})		x				XC9135B****-G
K	Output voltage internally set-up(V _{OUT})		x			x	XC9135K****-G
E	Output voltage internally set-up(V _{OUT})	x	x	x	x		XC9136E****-G
N	Output voltage internally set-up(V _{OUT})	x	x	x	x	x	XC9136N****-G

represents reference voltage and oscillation frequency

When mark is 5 or 6.

(XC9135A/C/B/K, XC9136E/N): Output Voltage

MARK		OUTPUT VOLTAGE(V)	PRODUCT SERIES
1	8	1.8	XC9135*18***-G XC9136*18***-G
3	3	3.3	XC9135*33***-G XC9136*33***-G

represents production lot number

01 ~ 09, 0A ~ 0Z, 11 ~ 9Z, A1 ~ A9, AA ~ Z9, ZA ~ ZZ in order.

(G, I, J, O, Q, W excluded)

*No character inversion used.

1. The products and product specifications contained herein are subject to change without notice to improve performance characteristics. Consult us, or our representatives before use, to confirm that the information in this datasheet is up to date.
2. We assume no responsibility for any infringement of patents, patent rights, or other rights arising from the use of any information and circuitry in this datasheet.
3. Please ensure suitable shipping controls (including fail-safe designs and aging protection) are in force for equipment employing products listed in this datasheet.
4. The products in this datasheet are not developed, designed, or approved for use with such equipment whose failure or malfunction can be reasonably expected to directly endanger the life of, or cause significant injury to, the user.
(e.g. Atomic energy; aerospace; transport; combustion and associated safety equipment thereof.)
5. Please use the products listed in this datasheet within the specified ranges.
Should you wish to use the products under conditions exceeding the specifications, please consult us or our representatives.
6. We assume no responsibility for damage or loss due to abnormal use.
7. All rights reserved. No part of this datasheet may be copied or reproduced without the prior permission of TOREX SEMICONDUCTOR LTD.

TOREX SEMICONDUCTOR LTD.

单击下面可查看定价，库存，交付和生命周期等信息

[>>Torex Semiconductor\(特瑞仕\)](#)