

Regulated Voltage Step-Up Charge Pump ICs

■ GENERAL DESCRIPTION

The XC9801 series are fixed regulated voltage step-up charge pump ICs which provide stable, highly efficient, positive voltages with the only external components required being 2 capacitors.

Since regulating is done via the control of the charge pump's gate voltage waveform, ripple is minimal. Output voltage is selectable in 100mV steps within a 2.5V ~ 6.0V range.

Control of the XC9802 switches to PFM (pulse skip) during light loads without affecting output impedance or ripple so that the IC is protected against drops in efficiency. Connecting the SENSE pin to the GND pin allows the IC to be used as a voltage doubler.

As well as the ultra small MSOP-8A and USP-8 packages, the small consumption current and high efficiencies of the series make the XC9801 suitable for use with all types of battery operated applications.

■ APPLICATIONS

- Palm top computers, PDAs
- On board local power supplies
- Various battery powered devices

■ FEATURES

Input Voltage Range	: 1.8V ~ 5.5V
Output Voltage Range	: 2.5V ~ 6.0V
Small Input Current	: 80 μ A (no load:XC9802)
Output Current	: 80mA (3.6V→5.0V step-up)
Oscillation Frequency	: 300kHz
Stand-by Current (CE 'L')	: 2.0 μ A (MAX.)
PFM Operation During Light Loads (XC9802)	
CE (Chip Enable) Function	
Can be used as a step-up doubler (sense = 0V)	
Packages	: MSOP-8A, USP-8
Environmentally Friendly	: EU RoHS Compliant, Pb Free

■ TYPICAL APPLICATION CIRCUIT

Regulation Output

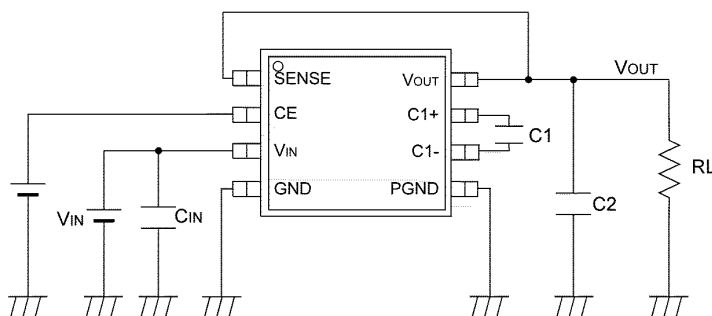

■ TYPICAL PERFORMANCE CHARACTERISTICS

XC9802B503KR(300kHz,5.0V)

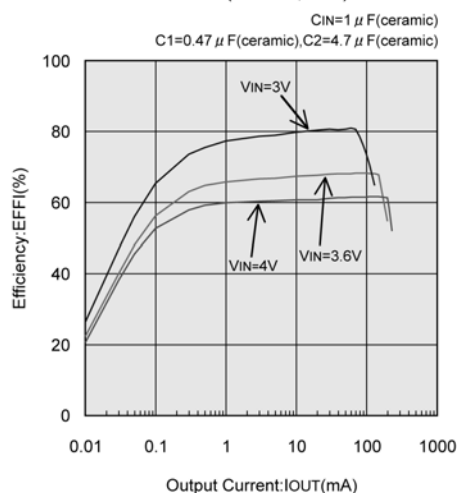

PIN CONFIGURATION

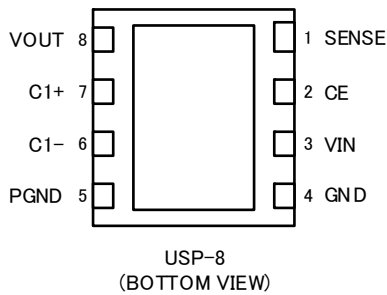
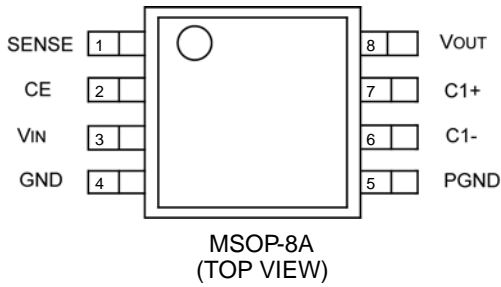

PIN ASSIGNMENT

PIN NUMBER		PIN NAME	FUNCTION
USP-8	MSOP-8A		
1	1	SENSE	Output Voltage Monitor
2	2	CE	Chip Enable (High Active)
3	3	VIN	Input (Power Supply)
4	4	GND	Ground
5	5	PGND	Power Ground
6	6	C1-	External Capacitor - Pin
7	7	C1+	External Capacitor + Pin
8	8	VOUT	Output

PRODUCT CLASSIFICATION

● Selection Guide

SERIES	PULSE SKIP MODE
XC9801	Not Available
XC9802	Available

● Ordering Information

XC9801/XC9802 ①②③④⑤⑥-⑦^(*)

DESIGNATOR	ITEM	SYMBOL	DESCRIPTION
①	True Logic Level at CE Pin	B	Positive
②③	Output Voltage	50	Standard voltage V _{OUT} =5.0V → ②=5, ③=0
		25 ~ 60	Semi-custom voltage e.g. V _{OUT} =2.5V → ②=2, ③=5
④	Oscillation Frequency	3	300kHz
⑤⑥-⑦	Packages (Order Unit)	KR	MSOP-8A (1,000/Reel)
		KR-G	MSOP-8A (1,000/Reel)
		DR	USP-8 (3,000/Reel)
		DR-G	USP-8 (3,000/Reel)

Regulated output voltage function cannot be used by the following input voltage condition:

$$V_{IN} < (V_{OUT}/2), \text{ or } V_{IN} \geq V_{OUT}$$

(*) The "-G" suffix denotes Halogen and Antimony free as well as being fully RoHS compliant.

■ BLOCK DIAGRAM

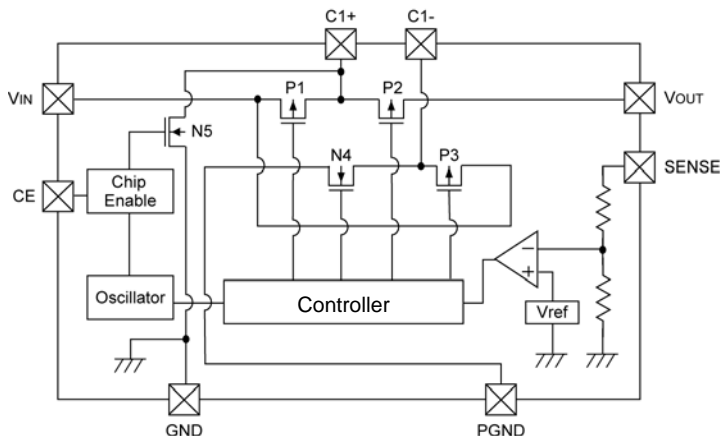

(1) Basic Operations

Using the XC9801/02's clock generated by the internal oscillator, a step-up charge pump operation can be brought about as a result of the alternate switching between operating conditions where P1 & N4 are ON with P2 & P3 OFF (or) P1 & N4 are OFF with P2 & P3 ON. By connecting the SENSE pin to V_{OUT}, output voltage can be feedback and the difference between the feedback voltage and the reference voltage (V_{ref}) are compared by the internal operational amplifier. Output voltage can be stabilized (* 2) by controlling P3's gate voltage waveform via the signal generated by the internal amplifier.

Please note that this stabilizing function will not operate with $V_{IN} < (V_{OUT}/2)$ or $V_{IN} \geq V_{OUT}$.

By connecting SENSE to ground, the output stability function, as described above, can be halted and the IC can be used as a step-up doubler.

* 2 : As a result of P3 gradually reaching an ON state with each clock (signal), rush current is controlled, the ripple decreases and with the combination of the independent phase compensation circuit, output voltage is stabilized

(2) Stand-by

When the voltage at CE (chip enable) is 'low' (0V), P1, P2 & P3 will be OFF with N4 & N5 ON. The external capacitor C1 will discharge and impedance at V_{OUT} will be high.

(3) PFM (Pulse Skip) Operations

Whilst maintaining output voltage, the XC9802 provides the added security of protection against drops in efficiency during light loads as a result of the pulse, generated by the internal oscillator, being skipped and the operating frequency being changed.

■ ABSOLUTE MAXIMUM RATINGS

T_a = 25°C, GND = 0V

PARAMETER	SYMBOL	CONDITIONS	UNITS
V _{IN} pin Voltage	V _{IN}	-0.3~6.0	V
V _{OUT} pin Voltage	V _{OUT}	-0.3~12.0	V
C1 + pin Voltage	C1+	-0.3~V _{OUT} +0.3	V
C1 - pin Voltage	C1-	-0.3~V _{OUT} +0.3	V
CE pin Voltage	V _{Ce}	-0.3~V _{IN} +0.3	V
V _{OUT} Pin Output Current	I _{OUT}	200	mA
Power Dissipation	MSOP-8A	P _d	mW
	USP-8		
Operating Temperature Range	T _{opr}	-40~+85	°C
Storage Temperature Range	T _{stg}	-40~+125	°C

ELECTRICAL CHARACTERISTICS

XC9801B503KR V_{OUT}=5.0V

T_a=25°C

PARAMETER	SYMBOL	CONDITIONS		MIN.	TYP.	MAX.	UNITS
Output Voltage	V _{OUT}	Regulation Output	I _{OUT} =1mA	4.875	5.000	5.125	V
Load Regulation	ΔV _{OUT}	Regulation Output	1mA ≤ I _{OUT} ≤ 80mA	-100	-	100	mV
Operating Voltage Range	V _{IN}	Doubler Output, V _{OUT} > V _{IN} × 2 × 0.95		1.8	-	5.5	V
Supply Current	I _{DD}	V _{IN} =3.6V, External Components=C _{IN} only, SENSE=0V, V _{OUT} =V _{IN}		1	3	6	mA
Stand-by Current	I _{STB}	CE=0V		-	-	2.0	μA
Oscillation Frequency	F _{OSC}	External Component=C _{IN} only, SENSE=0V, V _{OUT} open		255	300	345	kHz
Output Impedance	R _{OUT}	Doubler Output	I _{OUT} =10mA	-	20	40	Ω
Input Current	I _{IN}	Doubler Output		-	5	-	mA
	I _{IN2}	Regulation Output		-	1.5	-	mA
Voltage Converting Efficiency	V _{EFF1}	Doubler Output		95	99	-	%
Power Converting Efficiency	EFF1	Doubler Output	I _{OUT} =10mA	73	78	-	%
	EFFI2	Regulation Output	I _{OUT} =1mA	-	40	-	%
	EFFI3		I _{OUT} =80mA	64	69	-	%
CE / 'H' Level Voltage	V _{CEH}			1.5	-	-	V
CE / 'L' Level Voltage	V _{CEL}			-	-	0.25	V
CE / Input Current	I _{CE}	V _{IN} =5.5V, SENSE=0V, External Components=C _{IN} only		-2.0	-	2.0	μA

Test Conditions: Unless otherwise stated, Typical Application Circuit, V_{IN}=3.6V,
GND=0V, CE=V_{IN}, No Load, SENSE=V_{OUT} (Regulation Output)

XC9802B503KR V_{OUT}=5.0V

T_a=25°C

PARAMETER	SYMBOL	CONDITIONS		MIN.	TYP.	MAX.	UNITS
Output Voltage	V _{OUT}	Regulation Output	I _{OUT} =1mA	4.875	5.000	5.125	V
Load Regulation	ΔV _{OUT}	Regulation Output	1mA ≤ I _{OUT} ≤ 80mA	-100	-	100	mV
Operating Voltage Range	V _{IN}	Doubler Output, V _{OUT} > V _{IN} × 2 × 0.95		1.8	-	5.5	V
Supply Current	I _{DD}	V _{IN} =3.6V, External Components=C _{IN} only, SENSE=0V, V _{OUT} =V _{IN}		1	3	6	mA
Stand-by Current	I _{STB}	CE=0V		-	-	2.0	μA
Oscillation Frequency	F _{OSC}	External Component = C _{IN} only, SENSE=0V, V _{OUT} open		255	300	345	kHz
Switching Pulse Frequency	F _{OSC2}	Regulation Output	I _{OUT} =1mA	-	10	-	kHz
Output Impedance	R _{OUT}	Doubler Output	I _{OUT} =10mA	-	20	40	Ω
Input Current	I _{IN}	Doubler Output		-	5	-	mA
	I _{IN2}	Regulation Output		-	0.08	-	mA
Voltage Converting Efficiency	V _{EFF1}	Doubler Output		98	99	-	%
Power Converting Efficiency	EFF1	Doubler Output	I _{OUT} =10mA	73	78	-	%
	EFFI2	Regulation Output	I _{OUT} =1mA	-	59	-	%
	EFFI3		I _{OUT} =80mA	64	69	-	%
CE / 'H' Level Voltage	V _{CEH}			1.5	-	-	V
CE / 'L' Level Voltage	V _{CEL}			-	-	0.25	V
CE / Input Current	I _{CE}	V _{IN} =5.5V, SENSE=0V, External Components=C _{IN} only		-2.0	-	2.0	μA

Test Conditions: Unless otherwise stated, Typical Application Circuit, V_{IN}=3.6V,
GND=0V, CE=V_{IN}, No Load, SENSE=V_{OUT} (Regulation Output)

■ ELECTRICAL CHARACTERISTICS (Continued)

XC9801B333KR $V_{OUT}=3.3V$

$T_a=25^{\circ}C$

PARAMETER	SYMBOL	CONDITIONS		MIN.	TYP.	MAX.	UNITS
Output Voltage	V_{OUT}	Regulation Output	$I_{OUT}=1mA$	3.218	3.300	3.383	V
Load Regulation	ΔV_{OUT}	Regulation Output	$1mA \leq I_{OUT} \leq 2mA$	-66	-	66	mV
Operating Voltage Range	V_{IN}	Doubler Output, $V_{OUT} > V_{IN} \times 2 \times 0.95$		1.8	-	5.5	V
Supply Current	I_{DD}	$V_{IN}=3.6V$, External components= C_{IN} only, $SENSE=0V$, $V_{OUT}=V_{IN}$		1	3	6	mA
Stand-by Current	I_{STB}	$CE=0V$		-	-	2.0	μA
Oscillation Frequency	FOSC	External component= C_{IN} only, $SENSE=0V$, V_{OUT} open		255	300	345	kHz
Output Impedance	R_{OUT}	Doubler Output	$I_{OUT}=10mA$	-	20	40	Ω
Input Current	I_{IN}	Doubler Output		-	5	-	mA
	I_{IN2}	Regulation Output		-	1.1	-	mA
Voltage Converting Efficiency	V_{EFF1}	Doubler Output		95	99	-	%
Power Converting Efficiency	$EFF1$	Doubler Output	$I_{OUT}=10mA$	73	78	-	%
	$EFFI2$	Regulation Output	$I_{OUT}=1mA$	-	40	-	%
	$EFFI3$		$I_{OUT}=32mA$	64	69	-	%
CE / 'H' Level Voltage	V_{CEH}			1.5	-	-	V
CE / 'L' Level Voltage	V_{CEL}			-	-	0.25	V
CE / Input Current	I_{CE}	$V_{IN}=5.5V$, $SENSE=0V$, External Components= C_{IN} only		-2.0	-	2.0	μA

Test Conditions: Unless otherwise stated, Typical Application Circuit, $V_{IN}=2.376V$,
 $GND=0V$, $CE=V_{IN}$, No Load, $SENSE=V_{OUT}$ (Regulation Output)

XC9802B333KR $V_{OUT}=3.3V$

$T_a=25^{\circ}C$

PARAMETER	SYMBOL	CONDITIONS		MIN.	TYP.	MAX.	UNITS
Output Voltage	V_{OUT}	Regulation Output	$I_{OUT}=1mA$	3.218	3.300	3.383	V
Load Regulation	ΔV_{OUT}	Regulation Output	$1mA \leq I_{OUT} \leq 32mA$	-66	-	66	mV
Operating Voltage Range	V_{IN}	Doubler Output, $V_{OUT} > V_{IN} \times 2 \times 0.95$		1.8	-	5.5	V
Supply Current	I_{DD}	$V_{IN}=3.6V$, External Components= C_{IN} only, $SENSE=0V$, $V_{OUT}=V_{IN}$		1	3	6	mA
Stand-by Current	I_{STB}	$CE=0V$		-	-	2.0	μA
Oscillation Frequency	FOSC	External Component = C_{IN} only, $SENSE=0V$, V_{OUT} open		255	300	345	kHz
Switching Pulse Frequency	FOSC2	Regulation Output	$I_{OUT}=1mA$	-	10	-	kHz
Output Impedance	R_{OUT}	Doubler Output	$I_{OUT}=10mA$	-	20	40	Ω
Input Current	I_{IN}	Doubler Output		-	5	-	mA
	I_{IN2}	Regulation Output		-	0.08	-	mA
Voltage Converting Efficiency	V_{EFF1}	Doubler Output		98	99	-	%
Power Converting Efficiency	$EFF1$	Doubler Output	$I_{OUT}=10mA$	73	78	-	%
	$EFFI2$	Regulation Output	$I_{OUT}=1mA$	-	63	-	%
	$EFFI3$		$I_{OUT}=32mA$	64	69	-	%
CE / 'H' Level Voltage	V_{CEH}			1.5	-	-	V
CE / 'L' Level Voltage	V_{CEL}			-	-	0.25	V
CE / Input Current	I_{CE}	$V_{IN}=5.5V$, $SENSE=0V$, External Components= C_{IN} only		-2.0	-	2.0	μA

Test Conditions: Unless otherwise stated, Typical Application Circuit, $V_{IN}=2.376V$,
 $GND=0V$, $CE=V_{IN}$, No Load, $SENSE=V_{OUT}$ (Regulation Output)

TYPICAL APPLICATION CIRCUITS

① Regulation Output

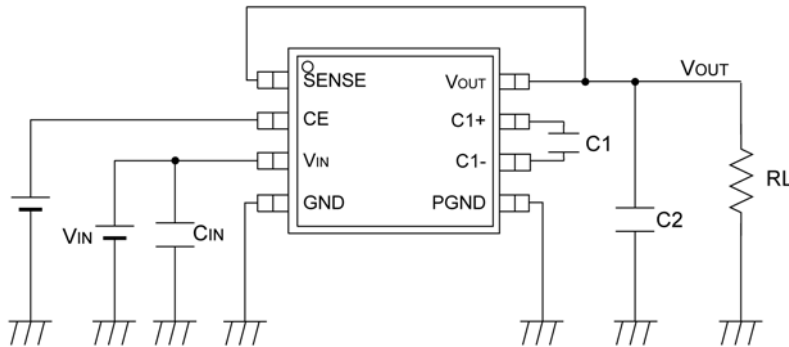

② Doubler Output

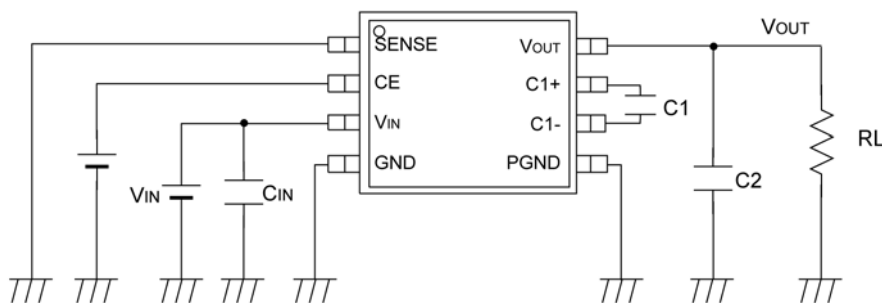

External Components:

$C_{IN}=1\ \mu\text{F}$ (Ceramic Capacitor: TAIYO YUDEN)

$C1=0.47\ \mu\text{F}$ (Ceramic Capacitor: TAIYO YUDEN)

$C2=4.7\ \mu\text{F}$ (Ceramic Capacitor: TAIYO YUDEN)

Note: The XC9801 series are step-up charge pump voltage doublers which provide regulated output voltage.

The application circuit of the doubler output (②) halts the regulated output function and operates as a normal voltage doubler.

The output voltage is stable when connected as in (①) above, except when $V_{IN} < (V_{OUT} / 2)$ and $V_{IN} \geq V_{OUT}$.

TYPICAL PERFORMANCE CHARACTERISTICS

● XC9801B333KR (300kHz, 3.3V)

(1) Output Voltage vs. Output Current

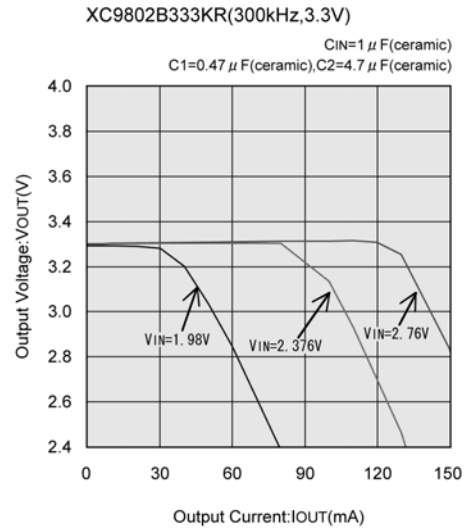
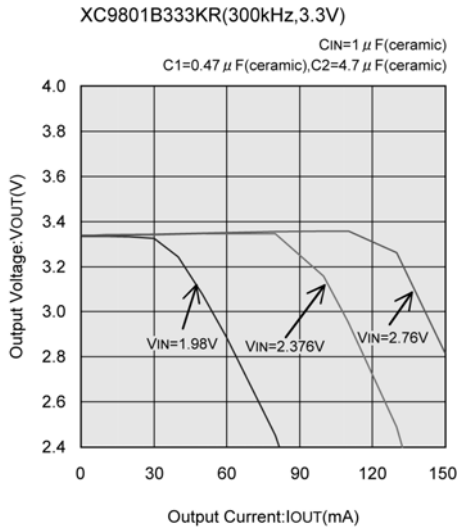

(2) Efficiency vs. Output Current

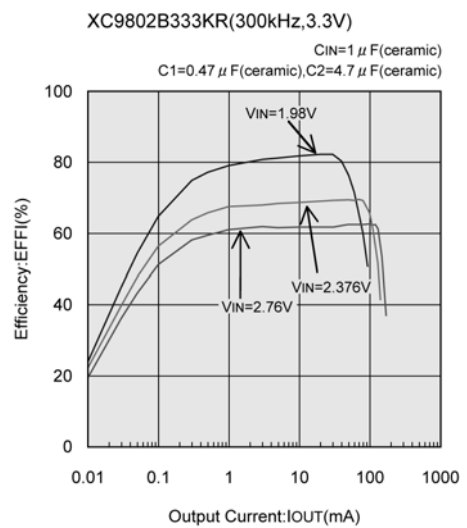
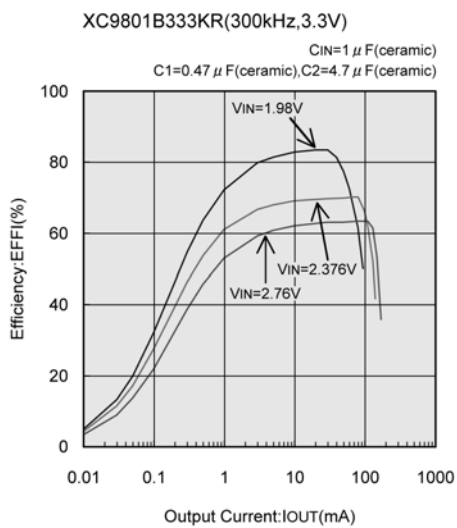

(3) Ripple Voltage vs. Output Current

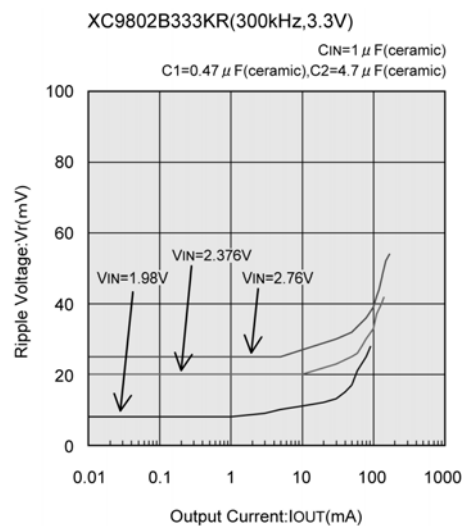
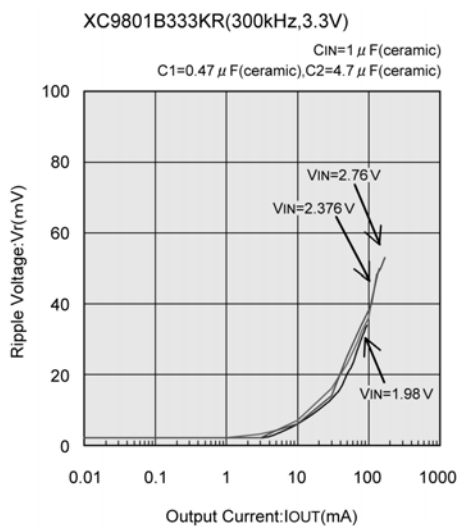

■ TYPICAL PERFORMANCE CHARACTERISTICS (Continued)

● XC9801B503KR (300kHz, 5.0V)

(1) Output Voltage vs. Output Current

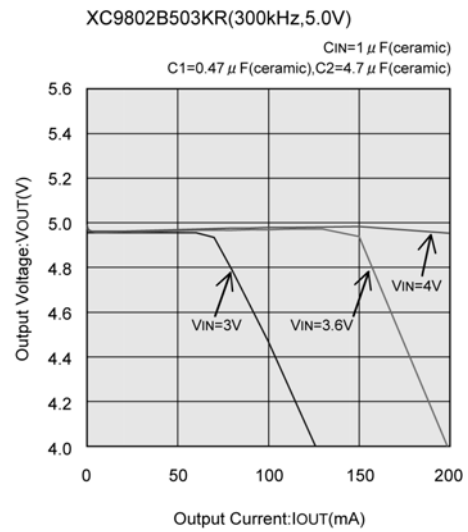
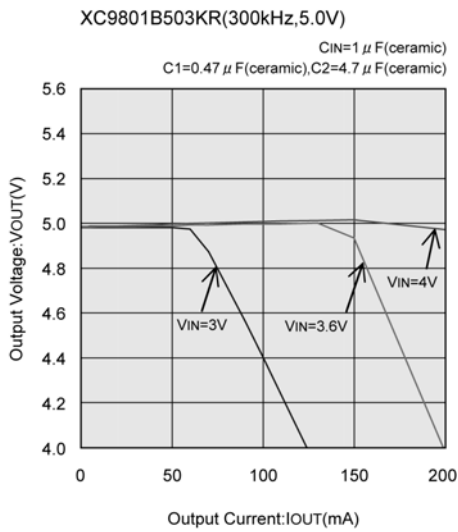

(2) Efficiency vs. Output Current

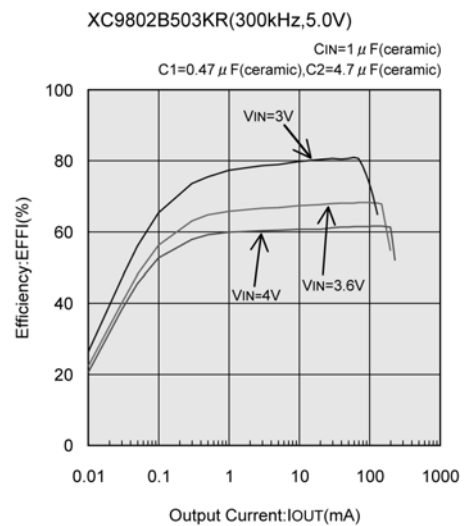
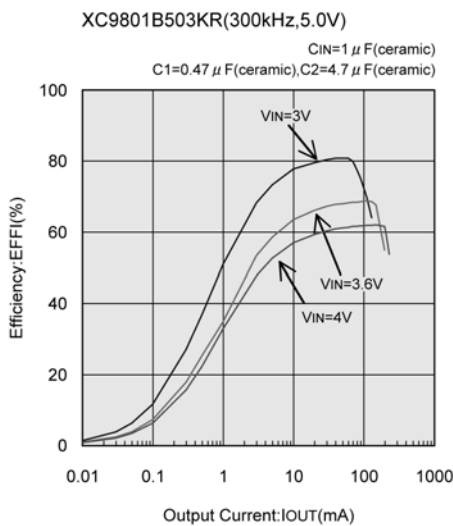

(3) Ripple Voltage vs. Output Current

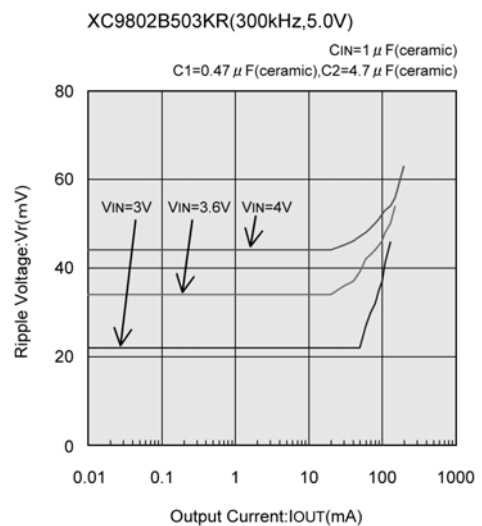
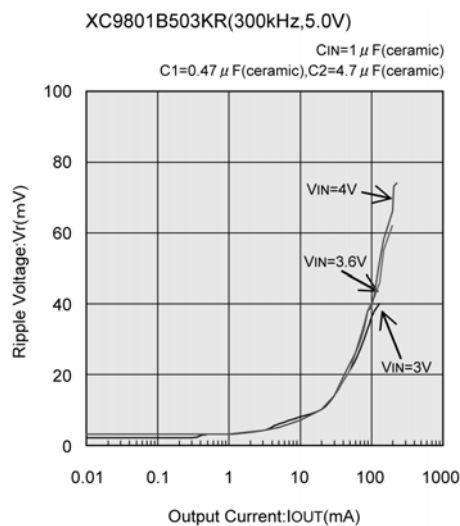

TYPICAL PERFORMANCE CHARACTERISTICS (Continued)

●XC9801B503KR (300kHz, SENSE=0V, Doubler)

(1) Output Voltage vs. Output Current

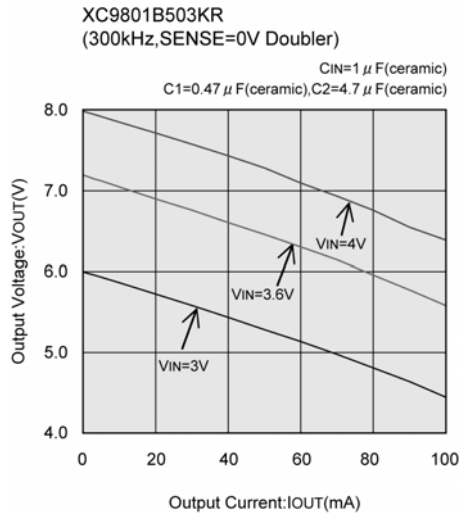

(2) Efficiency vs. Output Current

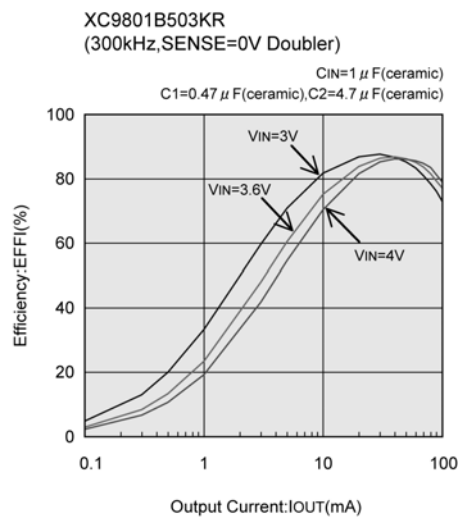

(3) Ripple Voltage vs. Output Current

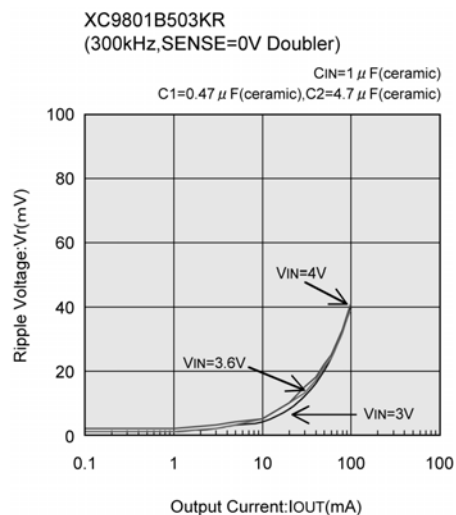

PACKAGING INFORMATION

● MSOP-8A

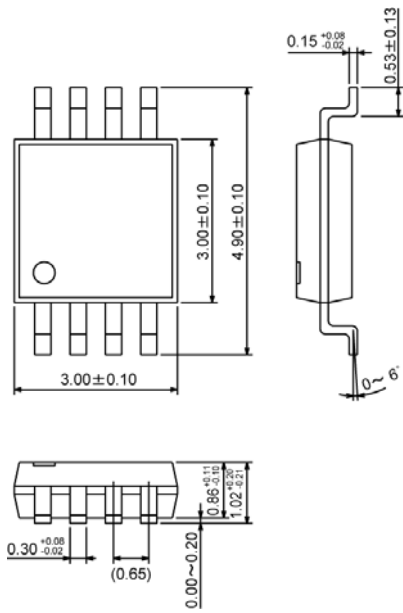

● USP-8

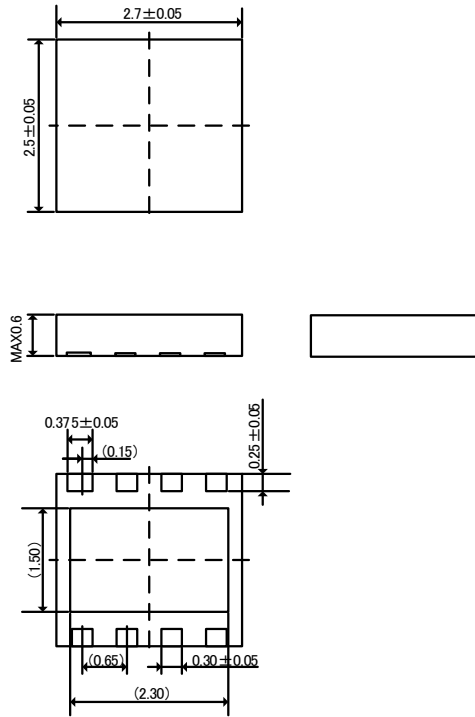

● USP-8 Recommended Pattern Layout

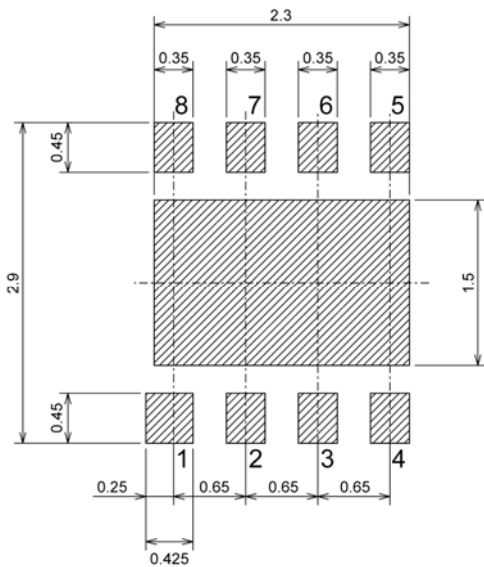

● USP-8 Recommended Metal Mask Design

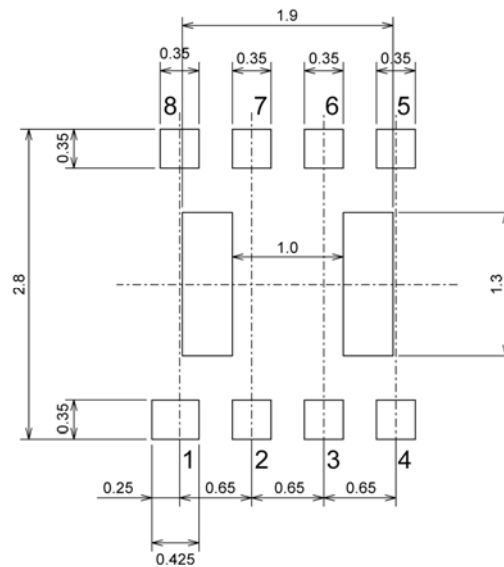

MARKING RULE

MSOP-8A

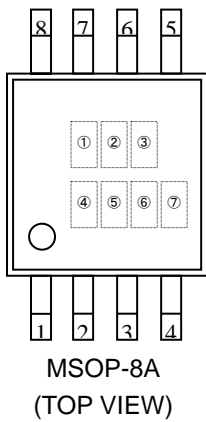

① represents product series

MARK	PRODUCT SERIES
2	XC9801Bxx3xx
3	XC9802Bxx3xx

② represents true logic level at the CE pin

MARK	PRODUCT SERIES
B	XC9801/XC9802Bxx3xx

③④ represents output voltage

MARK		VOLTAGE (V)	PRODUCT SERIES
③	④		
3	3	3.3	XC9801/XC9802B333xx
5	0	5.0	XC9801/XC9802B503xx

USP-8

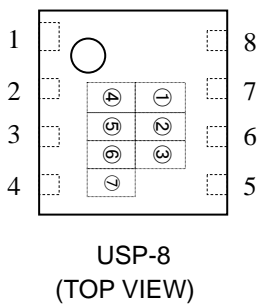

⑤ represents oscillation frequency

MARK	OSCILLATION FREQUENCY (kHz)	PRODUCT SERIES
3	300	XC9801/XC9802Bxx3xx

⑥⑦ represents production lot number

01~09, 0A~0Z, 11~9Z, A1~A9, AA~AZ, B1~ZZ in order.

(G, I, J, O, Q, W excluded)

* No character inversion used.

1. The product and product specifications contained herein are subject to change without notice to improve performance characteristics. Consult us, or our representatives before use, to confirm that the information in this datasheet is up to date.
2. The information in this datasheet is intended to illustrate the operation and characteristics of our products. We neither make warranties or representations with respect to the accuracy or completeness of the information contained in this datasheet nor grant any license to any intellectual property rights of ours or any third party concerning with the information in this datasheet.
3. Applicable export control laws and regulations should be complied and the procedures required by such laws and regulations should also be followed, when the product or any information contained in this datasheet is exported.
4. The product is neither intended nor warranted for use in equipment of systems which require extremely high levels of quality and/or reliability and/or a malfunction or failure which may cause loss of human life, bodily injury, serious property damage including but not limited to devices or equipment used in 1) nuclear facilities, 2) aerospace industry, 3) medical facilities, 4) automobile industry and other transportation industry and 5) safety devices and safety equipment to control combustions and explosions. Do not use the product for the above use unless agreed by us in writing in advance.
5. Although we make continuous efforts to improve the quality and reliability of our products; nevertheless Semiconductors are likely to fail with a certain probability. So in order to prevent personal injury and/or property damage resulting from such failure, customers are required to incorporate adequate safety measures in their designs, such as system fail safes, redundancy and fire prevention features.
6. Our products are not designed to be Radiation-resistant.
7. Please use the product listed in this datasheet within the specified ranges.
8. We assume no responsibility for damage or loss due to abnormal use.
9. All rights reserved. No part of this datasheet may be copied or reproduced unless agreed by Torex Semiconductor Ltd in writing in advance.

TOREX SEMICONDUCTOR LTD.

单击下面可查看定价，库存，交付和生命周期等信息

[>>Torex Semiconductor\(特瑞仕\)](#)