

28V Low Power Consumption 150mA Voltage Regulators (with Stand-by Function)

■ GENERAL DESCRIPTION

XC6216/XE6216 series are positive voltage regulator ICs with 28V of operation voltage. The series consists of a voltage reference, an error amplifier, a current limiter, a thermal shutdown circuit and a phase compensation circuit plus a driver transistor.

The output voltage is selectable in 0.1V increments within the range of 1.8V to 12V using laser trimming technologies. With external resistors, the output voltage range can be expanded from 2.0V to 23V. The output stabilization capacitor (CL) is also compatible with low ESR ceramic capacitors.

The over current protection circuit and the thermal shutdown circuit are built-in. These two protection circuits will operate when the output current reaches current limit level or the junction temperature reaches temperature limit level.

The CE function enables the output to be turned off and the IC becomes a stand-by mode resulting in greatly reduced power consumption.

■ APPLICATIONS

- Car audio, Car navigation systems
- Note PCs / Tablet PCs
- Mobile devices / terminals
- Digital still cameras / Camcorders
- Smart phones / Mobile phones
- Multi-function power supplies

■ FEATURES

| | |
|--------------------------------------|---|
| Max Output Current | : More than 150mA (200mA limit) ($V_{IN}=V_{OUT}+3.0V$) |
| Dropout Voltage | : 300mV@ $I_{OUT}=20mA$ |
| Input Voltage Range | : 2.0V~28.0V |
| Output Voltage Range | : 1.8V~12.0V (0.1V increments) 2.0V~23V with external resistors |
| Fixed Output Accuracy | : $\pm 2\%$ $\pm 1\%$ ($V_{out} \geq 2.00V$) $\pm 20mV$ ($V_{out} \leq 1.9V$) |
| Low Power Consumption | : 5 μA |
| Stand-by Current | : Less than 0.1 μA |
| High Ripple Rejection | : 30dB@1kHz |
| Operating Temperature | : $-40^{\circ}C \sim +85^{\circ}C$ |
| Low ESR Capacitor | : Ceramic Capacitor Compatible |
| Built-in Protection | : Current Limit Circuit Thermal Shutdown Circuit |
| Operating Ambient Temperature | : $-40^{\circ}C \sim +85^{\circ}C$ |
| Packages | : SOT-25, SOT-89, SOT-89-5, USP-6C, SOT-223, TO-252 USP-6B06, SOT-23 |
| Environmentally Friendly | : EU RoHS Compliant, Pb Free |

■ TYPICAL APPLICATION CIRCUIT

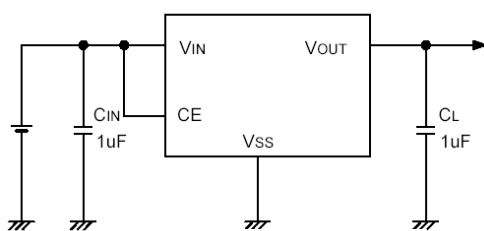

Fixed Output Voltage
XC6216B/XE6216B Series

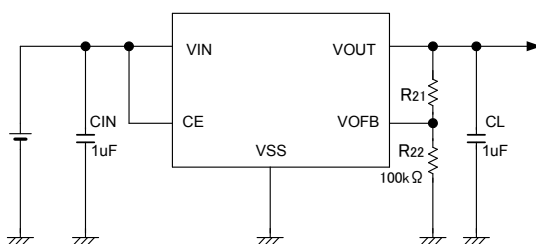

Output Voltage External Setting
XC6216C Series

■ TYPICAL PERFORMANCE CHARACTERISTICS

- Output Voltage vs. Input Voltage

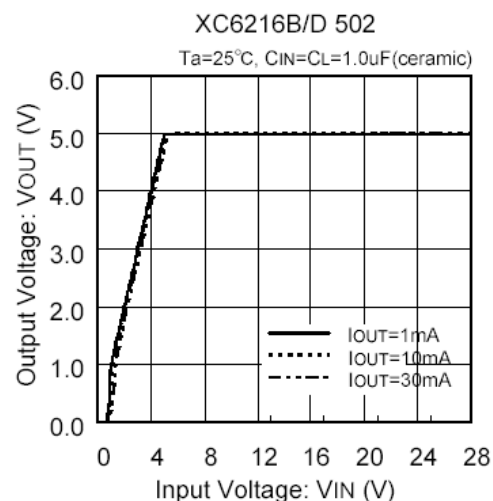

XC6216/XE6216 Series

■ BLOCK DIAGRAMS

● XC6216 Series

● XC6216 Series B Type

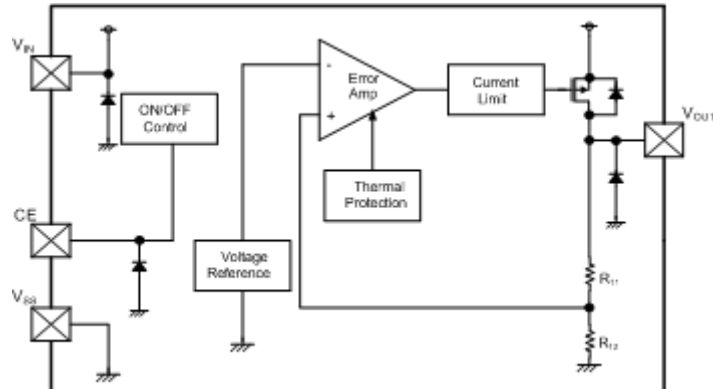

● XC6216 Series C Type

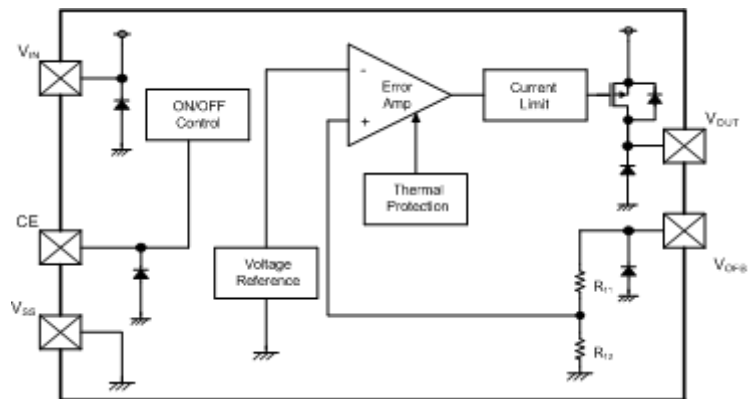

● XC6216 Series D Type

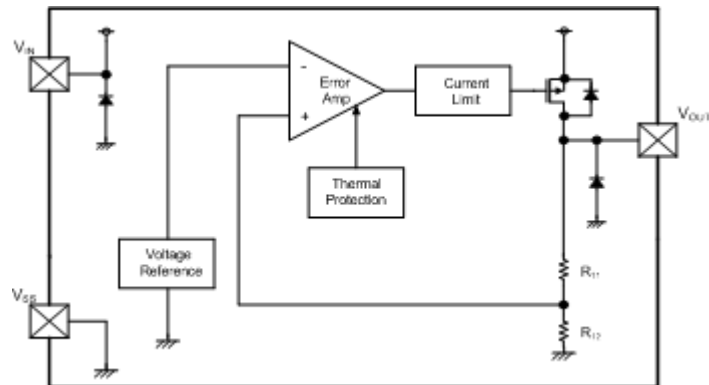

● XE6216 Series

● XE6216 Series B Type

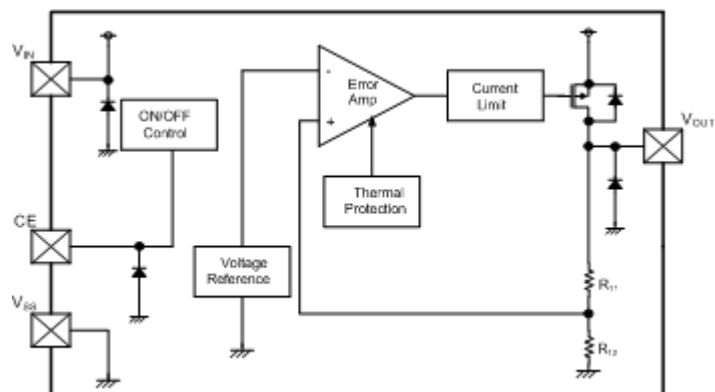

*Diodes inside the circuit are an ESD protection diode and parasitic diodes.

■ PRODUCT CLASSIFICATION

● Ordering Information

XC6216①②③④⑤⑥-⑦^(*): CE function (Active High) Fixed output voltage 1.8V~12.0V(0.1V increments)

| DESIGNATOR | ITEM | SYMBOL | DESCRIPTION |
|---------------------|--|---------|--|
| ① | Type and Options of Regulators | B | Fixed output voltage |
| | | C | Output voltage externally set ($V_{OFB}=2.0V$) ^(*) |
| ②③ | Output Voltage | 18 ~ C0 | For the voltage within 1.8V ~9.9V (0.1V increments); e.g. 2.5V ⇒ 25, 5.0V ⇒ 50 |
| | | | For the voltage within 10.0V~12.0V (0.1V increments); e.g. 10.6V ⇒ A6, 11.2V ⇒ B2, 12.0V ⇒ C0 |
| ④ | Output Voltage Accuracy ^(*) | 2 | ±2% |
| | | 1 | $V_{OUT} \geq 2.00V : \pm 1\%, V_{OUT} \leq 1.9V : \pm 20mV$ ^(*) |
| ⑤⑥-⑦ ^(*) | Packages (Order Unit) | MR | SOT-25 (3,000pcs/Reel) |
| | | MR-G | SOT-25 (3,000pcs/Reel) |
| | | PR | SOT-89-5 (1,000pcs/Reel) |
| | | PR-G | SOT-89-5 (1,000pcs/Reel) |
| | | ER | USP-6C (3,000pcs/Reel) |
| | | ER-G | USP-6C (3,000pcs/Reel) |
| | | 8R-G | USP-6B06 (5,000pcs/Reel) |

^(*) The "-G" suffix denotes Halogen and Antimony free as well as being fully EU RoHS compliant.

^(*) For the Type C, the accuracy is based on V_{OFB} voltage. The actual output voltage accuracy is depended on the external resistances.

^(*) For the Type C and Output Voltage Accuracy±1% (±20mV) do not haveUSP-6B06 package

XC6216D①②③④⑤-⑥^(*): 3 pin regulator (No CE function), Fixed output voltage 1.8V~12.0V(0.1V increments)

| DESIGNATOR | ITEM | SYMBOL | DESCRIPTION |
|---------------------|-------------------------|---------|---|
| ①② | Output Voltage | 20 ~ C0 | For the voltage within 1.8V~9.9V (0.1V increments); e.g. 2.5V ⇒ 25, 5.0V ⇒ 50 |
| | | | For the voltage within10.0V~12.0V (0.1V increments); e.g. 10.6V ⇒ A6, 11.2V ⇒ B2, 12.0V ⇒ C0 |
| ③ | Output Voltage Accuracy | 2 | ±2% |
| | | 1 | $V_{OUT} \geq 2.00V : \pm 1\%, V_{OUT} \leq 1.9V : \pm 20mV$ |
| ④⑤-⑥ ^(*) | Packages (Order Unit) | PR | SOT-89 (1,000pcs/Reel) |
| | | PR-G | SOT-89 (1,000pcs/Reel) |
| | | FR | SOT-223 (1,000pcs/Reel) |
| | | FR-G | SOT-223 (1,000pcs/Reel) |
| | | JR | TO-252 (2,500pcs/Reel) |
| | | JR-G | TO-252 (2,500pcs/Reel) |
| | | MR-G | SOT-23 (3,000pcs/Reel) |

^(*) The "-G" suffix denotes Halogen and Antimony free as well as being fully EU RoHS compliant.

XE6216B①②③④⑤-⑥^(*): CE function (Active High), Fixed output voltage 2.0V~12.0V(0.1V increments)

Characteristics are guaranteed over the temperature range of -40°C to 85°C.

| DESIGNATOR | ITEM | SYMBOL | DESCRIPTION |
|---------------------|-------------------------|--------|--|
| ①② | Output Voltage | 20~C0 | For the voltage within 2.0V ~9.9V (0.1V increments); e.g. 2.5V ⇒ 25, 5.0V ⇒ 50 |
| | | | For the voltage within 10.0V~12.0V (0.1V increments); e.g. 10.6V ⇒ A6, 11.2V ⇒ B2, 12.0V ⇒ C0 |
| ③ | Output Voltage Accuracy | 2 | ±2% |
| ④⑤-⑥ ^(*) | Package (Order Unit) | PR | SOT-89-5 (1,000pcs/Reel) |
| | | PR-G | SOT-89-5 (1,000pcs/Reel) |

^(*) The "-G" suffix denotes Halogen and Antimony free as well as being fully EU RoHS compliant.

PIN CONFIGURATION

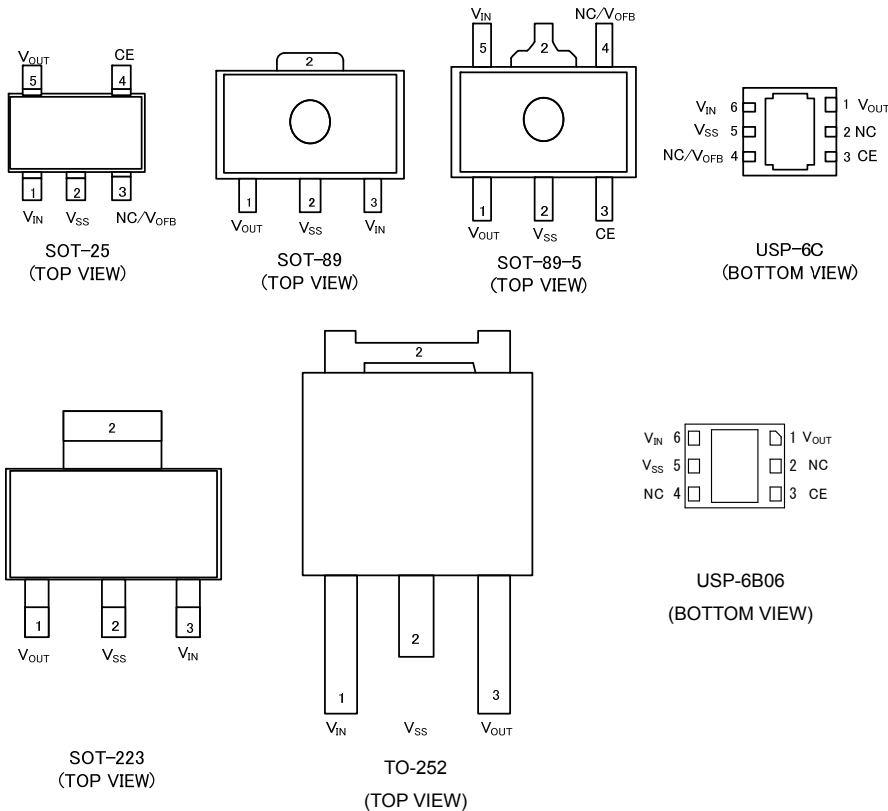

* The dissipation pad for the USP-6C and USP-6B06 packages should be solder-plated in reference mount pattern and metal masking so as to enhance mounting strength and heat release. If the pad needs to be connected to other pins, it should be connected to the V_{SS} (No. 5) pin.

PIN ASSIGNMENT

●XC6216 Series B Type

| PIN NUMBER | | | | PIN NAME | FUNCTIONS |
|------------|----------|--------|----------|------------------|----------------|
| SOT-25 | SOT-89-5 | USP-6C | USP-6B06 | | |
| 1 | 5 | 6 | 6 | V _{IN} | Power Input |
| 2 | 2 | 5 | 5 | V _{SS} | Ground |
| 3 | 4 | 2,4 | 2,4 | NC | No connection |
| 4 | 3 | 3 | 3 | CE | ON/OFF Control |
| 5 | 1 | 1 | 1 | V _{OUT} | Output |

●XC6216 Series C Type

| PIN NUMBER | | | PIN NAME | FUNCTIONS |
|------------|----------|--------|------------------|---------------------------|
| SOT-25 | SOT-89-5 | USP-6C | | |
| 1 | 5 | 6 | V _{IN} | Power Input |
| 2 | 2 | 5 | V _{SS} | Ground |
| 3 | 4 | 4 | V _{OFB} | Output Voltage Adjustment |
| 4 | 3 | 3 | CE | ON/OFF Control |
| 5 | 1 | 1 | V _{OUT} | Output |
| - | - | 2 | NC | No connection |

●XC6216 Series D Type

| PIN NUMBER | | | | PIN NAME | FUNCTIONS |
|------------|---------|--------|--------|------------------|-------------|
| SOT-89 | SOT-223 | TO-252 | SOT-23 | | |
| 3 | 3 | 1 | 2 | V _{IN} | Power Input |
| 2 | 2 | 2 | 3 | V _{SS} | Ground |
| 1 | 1 | 3 | 1 | V _{OUT} | Output |

■ PIN ASSIGNMENT

●XC6216 Series B Type

| PIN NUMBER | PIN NAME | FUNCTIONS |
|------------|------------------|----------------|
| SOT-89-5 | | |
| 1 | V _{OUT} | Output |
| 2 | V _{SS} | Ground |
| 3 | CE | ON/OFF Control |
| 4 | NC | No connection |
| 5 | V _{IN} | Power Input |

■ LOGIC CONDITION FOR THE PIN

| PIN NAME | DESIGNATOR | CONDITIONS | IC OPERATION |
|----------|------------|-------------------------------|-----------------|
| CE | L | $0V \leq V_{CE} \leq 0.35V$ | OFF |
| | H | $1.1V \leq V_{CE} \leq 28.0V$ | ON |
| | OPEN | CE=OPEN | Undefined state |

* Please avoid the state of OPEN, and make CE Pin arbitrary fixed potential.
(XC6216 Series B Type, XE6216 Series B Type, XC6216 Series C Type)

■ PIN FUNCTION ASSIGNMENT

| SERIES | CHIP ENABLE PIN |
|---|-----------------|
| XC6216 Series B Type/XE6216 Series B Type | Available |
| XC6216 Series C Type | Available |
| XC6216 Series D Type | Not Available |

■ ABSOLUTE MAXIMUM RATINGS

●XC6216 Series B Type

| PARAMETER | SYMBOL | RATINGS | UNITS |
|-------------------------------|------------------|--|-----------------|
| Input Voltage | V _{IN} | V _{SS} -0.3~+30 | V |
| Output Current | I _{OUT} | 300 ^{(*)1} | mA |
| Output Voltage | V _{OUT} | V _{SS} -0.3~V _{IN} +0.3 | V |
| CE Input Voltage | V _{CE} | V _{SS} -0.3~30 | V |
| Power Dissipation | Pd | 250 | mW (Ta=25°C) |
| | | 600 (40mm x 40mm Standard board) ^{(*)2} | |
| | | 500 | |
| | | 1300 (40mm x 40mm Standard board) ^{(*)2} | |
| | | 120 | |
| | | 1000 (40mm x 40mm Standard board) ^{(*)2} 1250(JEDEC board) ^{(*)2} | |
| Operating Ambient Temperature | T _{opr} | -40~+85 | °C |
| Storage Temperature | T _{stg} | -55~+125 | °C |

*1: $Pd > (V_{IN} - V_{OUT}) \times I_{OUT}$

*2: The power dissipation figure shown is PCB mounted and is for reference only.
Please see the power dissipation page for the mounting condition.

ABSOLUTE MAXIMUM RATINGS (Continued)

●XC6216 Series C Type

| PARAMETER | | SYMBOL | RATINGS | UNITS |
|-------------------------------|----------|-----------|---|----------------------------------|
| Input Voltage | | V_{IN} | $V_{SS}-0.3\sim+30$ | V |
| Output Current | | I_{OUT} | 300 ^{(*)1} | mA |
| Output Voltage | | V_{OUT} | $V_{SS}-0.3\sim V_{IN}+0.3$ | V |
| CE Input Voltage | | V_{CE} | $V_{SS}-0.3\sim+30$ | V |
| FB Voltage | | V_{OFB} | $V_{SS}-0.3\sim+30$ | V |
| Power Dissipation | SOT-25 | Pd | 250 | mW ($T_a=25^\circ\text{C}$) |
| | | | 600 (40mm x 40mm Standard board) ^{(*)2} | |
| | SOT-89-5 | | 500 | |
| | | | 1300 (40mm x 40mm Standard board) ^{(*)2} | |
| | USP-6C | | 120 | |
| | | | 1000 (40mm x 40mm Standard board) ^{(*)2} | |
| | SOP-8FD | | 1250(JEDEC board) ^{(*)2} | |
| 300 | | | | |
| Operating Ambient Temperature | | T_{opr} | -40~+85 | °C |
| Storage Temperature | | T_{stg} | -55~+125 | °C |

*1: $P_d > (V_{IN}-V_{OUT}) \times I_{OUT}$

*2: The power dissipation figure shown is PCB mounted and is for reference only.

Please see the power dissipation page for the mounting condition.

●XC6216D Series

| PARAMETER | | SYMBOL | RATINGS | UNITS |
|--|---------|-----------|---|----------------------------------|
| Input Voltage | | V_{IN} | $V_{SS}-0.3\sim+30$ | V |
| Output Current | | I_{OUT} | 300 ^{(*)1} | mA |
| Output Voltage | | V_{OUT} | $V_{SS}-0.3\sim V_{IN}+0.3$ | V |
| Power Dissipation | SOT-89 | Pd | 500 | mW ($T_a=25^\circ\text{C}$) |
| | | | 1000 (40mm x 40mm Standard board) ^{(*)2} | |
| | SOT-223 | | 300 | |
| | | | 1500 (40mm x 40mm Standard board) ^{(*)2} | |
| | TO-252 | | 500 | |
| | | | 1800 (40mm x 40mm Standard board) ^{(*)2} | |
| | SOT-23 | | 250 | |
| 500 (40mm x 40mm Standard board) ^{(*)2} | | | | |
| Operating Ambient Temperature | | T_{opr} | -40~+85 | °C |
| Storage Temperature | | T_{stg} | -55~+125 | °C |

*1: $P_d > (V_{IN}-V_{OUT}) \times I_{OUT}$

*2: The power dissipation figure shown is PCB mounted and is for reference only.

Please see the power dissipation page for the mounting condition.

●XE6216 Series B Type

| PARAMETER | | SYMBOL | RATINGS | UNITS |
|-------------------------------|----------|-----------|---|----------------------------------|
| Input Voltage | | V_{IN} | $V_{SS}-0.3\sim+30$ | V |
| Output Current | | I_{OUT} | 300 ^{(*)1} | mA |
| Output Voltage | | V_{OUT} | $V_{SS}-0.3\sim V_{IN}+0.3$ | V |
| CE Input Voltage | | V_{CE} | $V_{SS}-0.3\sim+30$ | V |
| Power Dissipation | SOT-89-5 | Pd | 500 | mW ($T_a=25^\circ\text{C}$) |
| | | | 1300 (40mm x 40mm Standard board) ^{(*)2} | |
| Operating Ambient Temperature | | T_{opr} | -40~+85 | °C |
| Junction Temperature | | T_J | -40~+125 | °C |
| Storage Temperature | | T_{stg} | -55~+125 | °C |

*1: $P_d > (V_{IN}-V_{OUT}) \times I_{OUT}$

*2: The power dissipation figure shown is PCB mounted and is for reference only.

Please see the power dissipation page for the mounting condition.

■ ELECTRICAL CHARACTERISTICS

● XC6216 Series B Type

Ta=25°C

| PARAMETER | SYMBOL | CONDITIONS | MIN. | TYP. | MAX. | UNITS | CIRCUIT |
|---|--|--|------|------|------|--------|---------|
| Output Voltage | V _{OUT(E)} ^(*2) | I _{OUT} =20mA, V _{CE} =V _{IN} | E-0 | | | V | ① |
| Maximum Output Current | I _{OUTMAX} | V _{IN} =V _{OUT(T)} +3.0V, V _{CE} =V _{IN} ^(*1) (V _{OUT(T)} ≥3.0V) | 150 | - | - | mA | ① |
| | | V _{IN} =V _{OUT(T)} +3.0V, V _{CE} =V _{IN} ^(*1) (V _{OUT(T)} <3.0V) | 100 | - | - | mA | ① |
| Load Regulation | ΔV _{OUT} | 1mA≤I _{OUT} ≤50mA, V _{CE} =V _{IN} (1.8V≤V _{OUT(T)} ≤7.0V) | - | 50 | 90 | mV | ① |
| | | 1mA≤I _{OUT} ≤50mA, V _{CE} =V _{IN} (7.0<V _{OUT(T)} ≤12.0V) | - | 110 | 140 | mV | ① |
| Dropout Voltage 1 | V _{dif1} ^(*3) | I _{OUT} =20mA, V _{CE} =V _{IN} | - | E-1 | | mV | ① |
| Dropout Voltage 2 | V _{dif2} ^(*3) | I _{OUT} =100mA, V _{CE} =V _{IN} | - | E-2 | | mV | ① |
| Supply Current | I _{SS} | V _{CE} =V _{IN} | 1 | 5 | 9 | μA | ② |
| Stand-by Current | I _{STB} | V _{CE} =V _{SS} | - | 0.01 | 0.10 | μA | ② |
| Line Regulation 1 | ΔV _{OUT} / (ΔV _{IN} · V _{OUT}) | V _{OUT(T)} +2.0V≤V _{IN} ≤28.0V ^(*1) I _{OUT} =5mA, V _{CE} =V _{IN} | - | 0.05 | 0.10 | %/V | ① |
| Line Regulation 2 | ΔV _{OUT} / (ΔV _{IN} · V _{OUT}) | V _{OUT(T)} +2.0V≤V _{IN} ≤28.0V ^(*1) I _{OUT} =13mA, V _{CE} =V _{IN} | - | 0.15 | 0.30 | %/V | ① |
| Input Voltage | V _{IN} | | 2.0 | - | 28.0 | V | - |
| Output Voltage Temperature Characteristics | ΔV _{OUT} / (ΔT _{opr} · V _{OUT}) | I _{OUT} =20mA, V _{CE} =V _{IN} -40°C≤T _{opr} ≤85°C | - | ±100 | - | ppm/°C | ① |
| Power Supply Rejection Ratio | PSRR | V _{IN} =[V _{OUT(T)} +2.0]V+0.5Vp-pAC ^(*1) I _{OUT} =20mA, f=1kHz, V _{CE} =V _{IN} | - | 30 | - | dB | ③ |
| Short Current | I _{SHORT} | V _{CE} =V _{IN} ^(*1) | - | 30 | - | mA | ① |
| CE "H" Level Voltage | V _{CEH} | - | 1.1 | - | 28.0 | V | ① |
| CE "L" Level Voltage | V _{CEL} | - | 0 | - | 0.35 | V | ① |
| CE "H" Level Current | I _{CEH} | V _{IN} =V _{CE} =28.0V | -0.1 | - | 0.1 | μA | ① |
| CE "L" Level Current | I _{CEL} | V _{IN} =28.0V, V _{CE} =V _{SS} | -0.1 | - | 0.1 | μA | ① |
| Thermal Shutdown Detect Temperature | T _{TSD} | V _{CE} =V _{IN} Junction Temperature | - | 150 | - | °C | ① |
| Thermal Shutdown Release Temperature | T _{TSR} | V _{CE} =V _{IN} Junction Temperature | - | 125 | - | °C | ① |
| Hysteresis Width | T _{TSD} -T _{TSR} | V _{CE} =V _{IN} Junction Temperature | - | 25 | - | °C | - |

Unless otherwise stated, V_{IN}=V_{OUT(T)}+2.0V.

NOTE:

*1: V_{OUT(T)}: Nominal output voltage

*2: V_{OUT(E)}: Effective output voltage

(i.e. the output voltage when "V_{OUT(T)}+2.0V" is provided at the V_{IN} pin while maintaining a certain I_{OUT} value.)

*3: V_{dif}={V_{IN1} - V_{OUT1}}

V_{OUT1}: V_{OUT(T)}<3.0V, A voltage equal to 98% of the output voltage whenever an amply stabilized I_{OUT}{V_{OUT(T)}+3.0V} is input.

V_{OUT(T)}≥3.0V, A voltage equal to 98% of the output voltage whenever an amply stabilized I_{OUT}{V_{OUT(T)}+2.0V} is input.

V_{IN1}: The input voltage when V_{OUT1} appears as input voltage is gradually decreased.

ELECTRICAL CHARACTERISTICS (Continued)

●XC6216 Series C Type

Ta=25°C

| PARAMETER | SYMBOL | CONDITIONS | MIN. | TYP. | MAX. | UNITS | CIRCUIT |
|--|---|---|------|------|------|--------|---------|
| Output Voltage (Accuracy±2%) | $V_{OUT(E)}^{(*2)}$ | $V_{IN}=4.0V, I_{OUT}=20mA, V_{CE}=V_{IN}, V_{OFB}=V_{OUT}$ | 1.96 | 2.00 | 2.04 | V | ① |
| Output Voltage (Accuracy±1%) | $V_{OUT(E)}^{(*2)}$ | $V_{IN}=4.0V, I_{OUT}=20mA, V_{CE}=V_{IN}, V_{OFB}=V_{OUT}$ | 1.98 | 2.00 | 2.02 | | |
| Divided Resistor | R_{FB} | $V_{IN}=V_{OUT}=5.0V, V_{CE}=V_{SS}, V_{OFB}=V_{OUT}$ | 1.70 | 4.10 | 6.30 | MΩ | ④ |
| Maximum Output Current | I_{OUTMAX} | $V_{IN}=5.0V, V_{CE}=V_{IN}, V_{OFB}=V_{OUT}$ | 100 | - | - | mA | ① |
| Load Regulation | ΔV_{OUT} | $V_{IN}=4.0V, 1mA \leq I_{OUT} \leq 50mA, V_{CE}=V_{IN}, V_{OFB}=V_{OUT}$ | - | 50 | 90 | mV | ① |
| Dropout Voltage1 | $V_{dif1}^{(*3)}$ | $I_{OUT}=20mA, V_{CE}=V_{IN}, V_{OFB}=V_{OUT}$ | - | 450 | 600 | mV | ① |
| Dropout Voltage2 | $V_{dif2}^{(*3)}$ | $I_{OUT}=100mA, V_{CE}=V_{IN}, V_{OFB}=V_{OUT}$ | - | 1900 | 2600 | mV | ① |
| Supply Current | I_{SS} | $V_{IN}=4.0V, V_{CE}=V_{IN}, V_{OFB}=V_{OUT}$ | 1 | 5 | 9 | μA | ② |
| Stand-by Current | I_{STB} | $V_{IN}=4.0V, V_{CE}=V_{SS}, V_{OFB}=V_{OUT}$ | - | 0.01 | 0.10 | μA | ② |
| Line Regulation1 | $\frac{\Delta V_{OUT}}{(\Delta V_{IN} \cdot V_{OUT})}$ | $4.0V \leq V_{IN} \leq 28.0V, I_{OUT}=5mA, V_{CE}=V_{IN}, V_{OFB}=V_{OUT}$ | - | 0.05 | 0.10 | %/V | ① |
| Line Regulation2 | $\frac{\Delta V_{OUT}}{(\Delta V_{IN} \cdot V_{OUT})}$ | $4.0V \leq V_{IN} \leq 28.0V, I_{OUT}=13mA, V_{CE}=V_{IN}, V_{OFB}=V_{OUT}$ | - | 0.15 | 0.30 | %/V | ① |
| Input Voltage | V_{IN} | | 2.0 | - | 28.0 | V | - |
| Output Voltage Temperature Characteristics | $\frac{\Delta V_{OUT}}{(\Delta T_{opr} \cdot V_{OUT})}$ | $V_{IN}=4.0V, I_{OUT}=20mA, V_{CE}=V_{IN}, V_{OFB}=V_{OUT}, -40^{\circ}C \leq T_{opr} \leq 85^{\circ}C$ | - | ±100 | - | ppm/°C | ① |
| Power Supply Rejection Ratio | PSRR | $V_{IN}=4.0V+0.5Vp-pAC, I_{OUT}=20mA, f=1kHz, V_{CE}=V_{IN}, V_{OFB}=V_{OUT}$ | - | 30 | - | dB | ③ |
| Short Current | I_{SHORT} | $V_{IN}=4.0V, V_{CE}=V_{IN}, V_{OFB}=V_{OUT}$ | - | 30 | - | mA | ① |
| CE "H" Level Voltage | V_{CEH} | $V_{IN}=4.0V, V_{OFB}=V_{OUT}$ | 1.1 | - | 28.0 | V | ① |
| CE "L" Level Voltage | V_{CEL} | $V_{IN}=4.0V, V_{OFB}=V_{OUT}$ | 0 | - | 0.35 | V | ① |
| CE "H" Level Current | I_{CEH} | $V_{IN}=V_{CE}=28.0V, V_{OFB}=V_{OUT}$ | -0.1 | - | 0.1 | μA | ① |
| CE "L" Level Current | I_{CEL} | $V_{IN}=28.0V, V_{CE}=V_{SS}, V_{OFB}=V_{OUT}$ | -0.1 | - | 0.1 | μA | ① |
| Thermal Shutdown Detect Temperature | T_{TSD} | $V_{IN}=4.0V, V_{CE}=V_{IN}$ Junction Temperature | - | 150 | - | °C | ① |
| Thermal Shutdown Release Temperature | T_{TSR} | $V_{IN}=4.0V, V_{CE}=V_{IN}$ Junction Temperature | - | 125 | - | °C | ① |
| Hysteresis Width | $T_{TSD}-T_{TSR}$ | $V_{IN}=4.0V, V_{CE}=V_{IN}$ Junction Temperature | - | 25 | - | °C | - |

NOTE:

*1: $V_{OUT(T)}$: Nominal output voltage C type is 2.0V.

*2: $V_{OUT(E)}$: Effective output voltage

(i.e. the output voltage when " $V_{OUT(T)}+2.0V$ " is provided at the V_{IN} pin while maintaining a certain I_{OUT} value.)

*3: $V_{dif}=\{V_{IN1} - V_{OUT1}\}$

V_{OUT1} : $V_{OUT(T)} < 3.0V$, A voltage equal to 98% of the output voltage whenever an amply stabilized $I_{OUT}\{V_{OUT(T)}+3.0V\}$ is input.

$V_{OUT(T)} \geq 3.0V$, A voltage equal to 98% of the output voltage whenever an amply stabilized $I_{OUT}\{V_{OUT(T)}+2.0V\}$ is input.

V_{IN1} : The input voltage when V_{OUT1} appears as input voltage is gradually decreased.

■ ELECTRICAL CHARACTERISTICS (Continued)

● XC6216 Series D type

Ta=25°C

| PARAMETER | SYMBOL | CONDITIONS | MIN. | TYP. | MAX. | UNITS | CIRCUIT |
|--|--|--|------|------|------|--------|---------|
| Output Voltage | V _{OUT(E)} ^(*2) | I _{OUT} =20mA | E-0 | | | V | ① |
| Maximum Output Current | I _{OUTMAX} | V _{IN} =V _{OUT(T)} +3.0V ^(*1) (V _{OUT(T)} ≥3.0V) | 150 | - | - | mA | ① |
| | | V _{IN} =V _{OUT(T)} +3.0V ^(*1) (V _{OUT(T)} <3.0V) | 100 | - | - | mA | ① |
| Load Regulation | ΔV _{OUT} | 1mA≤I _{OUT} ≤50mA (1.8V≤V _{OUT(T)} ≤7.0V) | - | 50 | 90 | mV | ① |
| | | 1mA≤I _{OUT} ≤50mA (7.0V<V _{OUT(T)} ≤12.0V) | - | 110 | 140 | mV | ① |
| Dropout Voltage1 | V _{dif1} ^(*3) | I _{OUT} =20mA | - | E-1 | | mV | ① |
| Dropout Voltage2 | V _{dif2} ^(*3) | I _{OUT} =100mA | - | E-2 | | mV | ① |
| Supply Current | I _{SS} | | 1 | 5 | 9 | μA | ② |
| Line Regulation1 | ΔV _{OUT} / (ΔV _{IN} · V _{OUT}) | V _{OUT(T)} +2.0V≤V _{IN} ≤28.0V ^(*1) I _{OUT} =5mA | - | 0.05 | 0.10 | %/V | ① |
| Line Regulation2 | ΔV _{OUT} / (ΔV _{IN} · V _{OUT}) | V _{OUT(T)} +2.0V≤V _{IN} ≤28.0V ^(*1) I _{OUT} =13mA | - | 0.15 | 0.30 | %/V | ① |
| Input Voltage | V _{IN} | | 2.0 | - | 28.0 | V | - |
| Output Voltage Temperature Characteristics | ΔV _{OUT} / (ΔT _{opr} · V _{OUT}) | I _{OUT} =20mA -40°C≤T _{opr} ≤85°C | - | ±100 | - | ppm/°C | ① |
| Power Supply Rejection Ratio | PSRR | V _{IN} =[V _{OUT(T)} +2.0]V+0.5Vp-pAC ^(*1) I _{OUT} =20mA, f=1kHz | - | 30 | - | dB | ③ |
| Short Current | I _{SHORT} | V _{IN} =V _{OUT(T)} +2.0V ^(*1) | - | 30 | - | mA | ① |
| Thermal Shutdown Detect Temperature | T _{TSD} | Junction Temperature | - | 150 | - | °C | ① |
| Thermal Shutdown Release Temperature | T _{TSR} | Junction Temperature | - | 125 | - | °C | ① |
| Hysteresis Width | T _{TSD} -T _{TSR} | Junction Temperature | - | 25 | - | °C | - |

Unless otherwise stated, V_{IN}=V_{OUT(T)}+2.0V.

NOTE:

*1: V_{OUT(T)}: Nominal output voltage

*2: V_{OUT(E)}: Effective output voltage

(i.e. the output voltage when "V_{OUT(T)}+2.0V" is provided at the V_{IN} pin while maintaining a certain I_{OUT} value.)

*3: V_{dif}={V_{IN1} - V_{OUT1}}

V_{OUT1}: V_{OUT(T)}<3.0V, A voltage equal to 98% of the output voltage whenever an amply stabilized I_{OUT}{V_{OUT(T)}+3.0V} is input.

V_{OUT1}: V_{OUT(T)}≥3.0V, A voltage equal to 98% of the output voltage whenever an amply stabilized I_{OUT}{V_{OUT(T)}+2.0V} is input.

V_{IN1}: The input voltage when V_{OUT1} appears as input voltage is gradually decreased.

ELECTRICAL CHARACTERISTICS (Continued)

● Voltage Chart (XC6216 Series)

| PARAMETER | E-0 | | | | E-1 | | E-2 | |
|---------------------------|-----------------------------------|-------|-----------------------------------|-------|--|------|---|------|
| NOMINAL OUTPUT VOLTAGE(V) | OUTPUT VOLTAGE (V) 2% ACCURACY | | OUTPUT VOLTAGE (V) 1% ACCURACY | | DROPOUT VOLTAGE 1 (mV) I _{OUT} =20mA | | DROPOUT VOLTAGE 2 (mV) I _{OUT} =100mA | |
| V _{OUT(T)} | V _{OUT(E)} | | V _{OUT(E)} | | V _{dif1} | | V _{dif2} | |
| | MIN. | MAX. | MIN. | MAX. | TYP. | MAX. | TYP. | MAX. |
| 1.8 | 1.764 | 1.836 | 1.780 | 1.820 | 550 | 710 | 2200 | 2700 |
| 1.9 | 1.862 | 1.938 | 1.880 | 1.920 | 550 | 710 | 2200 | 2700 |
| 2.0 | 1.960 | 2.040 | 1.980 | 2.020 | 450 | 600 | 1900 | 2600 |
| 2.1 | 2.058 | 2.142 | 2.079 | 2.121 | 450 | 600 | 1900 | 2600 |
| 2.2 | 2.156 | 2.244 | 2.178 | 2.222 | 390 | 520 | 1700 | 2200 |
| 2.3 | 2.254 | 2.346 | 2.277 | 2.323 | 390 | 520 | 1700 | 2200 |
| 2.4 | 2.352 | 2.448 | 2.376 | 2.424 | 390 | 520 | 1700 | 2200 |
| 2.5 | 2.450 | 2.550 | 2.475 | 2.525 | 310 | 450 | 1500 | 1900 |
| 2.6 | 2.548 | 2.652 | 2.574 | 2.626 | 310 | 450 | 1500 | 1900 |
| 2.7 | 2.646 | 2.754 | 2.673 | 2.727 | 310 | 450 | 1500 | 1900 |
| 2.8 | 2.744 | 2.856 | 2.772 | 2.828 | 310 | 450 | 1500 | 1900 |
| 2.9 | 2.842 | 2.958 | 2.871 | 2.929 | 310 | 450 | 1500 | 1900 |
| 3.0 | 2.940 | 3.060 | 2.970 | 3.030 | 260 | 360 | 1300 | 1700 |
| 3.1 | 3.038 | 3.162 | 3.069 | 3.131 | 260 | 360 | 1300 | 1700 |
| 3.2 | 3.136 | 3.264 | 3.168 | 3.232 | 260 | 360 | 1300 | 1700 |
| 3.3 | 3.234 | 3.366 | 3.267 | 3.333 | 260 | 360 | 1300 | 1700 |
| 3.4 | 3.332 | 3.468 | 3.366 | 3.434 | 260 | 360 | 1300 | 1700 |
| 3.5 | 3.430 | 3.570 | 3.465 | 3.535 | 260 | 360 | 1300 | 1700 |
| 3.6 | 3.528 | 3.672 | 3.564 | 3.636 | 260 | 360 | 1300 | 1700 |
| 3.7 | 3.626 | 3.774 | 3.663 | 3.737 | 260 | 360 | 1300 | 1700 |
| 3.8 | 3.724 | 3.876 | 3.762 | 3.838 | 260 | 360 | 1300 | 1700 |
| 3.9 | 3.822 | 3.978 | 3.861 | 3.939 | 260 | 360 | 1300 | 1700 |
| 4.0 | 3.920 | 4.080 | 3.960 | 4.040 | 220 | 320 | 1100 | 1500 |
| 4.1 | 4.018 | 4.182 | 4.059 | 4.141 | 220 | 320 | 1100 | 1500 |
| 4.2 | 4.116 | 4.284 | 4.158 | 4.242 | 220 | 320 | 1100 | 1500 |
| 4.3 | 4.214 | 4.386 | 4.257 | 4.343 | 220 | 320 | 1100 | 1500 |
| 4.4 | 4.312 | 4.488 | 4.356 | 4.444 | 220 | 320 | 1100 | 1500 |
| 4.5 | 4.410 | 4.590 | 4.455 | 4.545 | 220 | 320 | 1100 | 1500 |
| 4.6 | 4.508 | 4.692 | 4.554 | 4.646 | 220 | 320 | 1100 | 1500 |
| 4.7 | 4.606 | 4.794 | 4.653 | 4.747 | 220 | 320 | 1100 | 1500 |
| 4.8 | 4.704 | 4.896 | 4.752 | 4.848 | 220 | 320 | 1100 | 1500 |
| 4.9 | 4.802 | 4.998 | 4.851 | 4.949 | 220 | 320 | 1100 | 1500 |

■ ELECTRICAL CHARACTERISTICS (Continued)

● Voltage Chart (XC6216 Series) (Continued)

| PARAMETER | E-0 | | | | E-1 | | E-2 | |
|---------------------------|-----------------------------------|-------|-----------------------------------|-------|--|------|---|------|
| NOMINAL OUTPUT VOLTAGE(V) | OUTPUT VOLTAGE (V) 2% ACCURACY | | OUTPUT VOLTAGE (V) 1% ACCURACY | | DROPOUT VOLTAGE 1 (mV) I _{OUT} =20mA | | DROPOUT VOLTAGE 2 (mV) I _{OUT} =100mA | |
| V _{OUT(T)} | V _{OUT(E)} | | V _{OUT(E)} | | V _{dif1} | | V _{dif2} | |
| | MIN. | MAX. | MIN. | MAX. | TYP. | MAX. | TYP. | MAX. |
| 5.0 | 4.900 | 5.100 | 4.950 | 5.050 | 190 | 280 | 1000 | 1300 |
| 5.1 | 4.998 | 5.202 | 5.049 | 5.151 | 190 | 280 | 1000 | 1300 |
| 5.2 | 5.096 | 5.304 | 5.148 | 5.252 | 190 | 280 | 1000 | 1300 |
| 5.3 | 5.194 | 5.406 | 5.247 | 5.353 | 190 | 280 | 1000 | 1300 |
| 5.4 | 5.292 | 5.508 | 5.346 | 5.454 | 190 | 280 | 1000 | 1300 |
| 5.5 | 5.390 | 5.610 | 5.445 | 5.555 | 190 | 280 | 1000 | 1300 |
| 5.6 | 5.488 | 5.712 | 5.544 | 5.656 | 190 | 280 | 1000 | 1300 |
| 5.7 | 5.586 | 5.814 | 5.643 | 5.757 | 190 | 280 | 1000 | 1300 |
| 5.8 | 5.684 | 5.916 | 5.742 | 5.916 | 190 | 280 | 1000 | 1300 |
| 5.9 | 5.782 | 6.018 | 5.841 | 5.959 | 190 | 280 | 1000 | 1300 |
| 6.0 | 5.880 | 6.120 | 5.940 | 6.060 | 190 | 280 | 1000 | 1300 |
| 6.1 | 5.978 | 6.222 | 6.039 | 6.161 | 190 | 280 | 1000 | 1300 |
| 6.2 | 6.076 | 6.324 | 6.138 | 6.262 | 190 | 280 | 1000 | 1300 |
| 6.3 | 6.174 | 6.426 | 6.237 | 6.363 | 190 | 280 | 1000 | 1300 |
| 6.4 | 6.272 | 6.528 | 6.336 | 6.464 | 190 | 280 | 1000 | 1300 |
| 6.5 | 6.370 | 6.630 | 6.435 | 6.565 | 170 | 230 | 800 | 1150 |
| 6.6 | 6.468 | 6.732 | 6.534 | 6.666 | 170 | 230 | 800 | 1150 |
| 6.7 | 6.566 | 6.834 | 6.633 | 6.767 | 170 | 230 | 800 | 1150 |
| 6.8 | 6.664 | 6.936 | 6.732 | 6.868 | 170 | 230 | 800 | 1150 |
| 6.9 | 6.762 | 7.038 | 6.831 | 6.969 | 170 | 230 | 800 | 1150 |
| 7.0 | 6.860 | 7.140 | 6.930 | 7.070 | 170 | 230 | 800 | 1150 |
| 7.1 | 6.958 | 7.242 | 7.029 | 7.171 | 170 | 230 | 800 | 1150 |
| 7.2 | 7.056 | 7.344 | 7.128 | 7.272 | 170 | 230 | 800 | 1150 |
| 7.3 | 7.154 | 7.446 | 7.227 | 7.373 | 170 | 230 | 800 | 1150 |
| 7.4 | 7.252 | 7.548 | 7.326 | 7.474 | 170 | 230 | 800 | 1150 |
| 7.5 | 7.350 | 7.650 | 7.425 | 7.575 | 170 | 230 | 800 | 1150 |
| 7.6 | 7.448 | 7.752 | 7.524 | 7.676 | 170 | 230 | 800 | 1150 |
| 7.7 | 7.546 | 7.854 | 7.623 | 7.777 | 170 | 230 | 800 | 1150 |
| 7.8 | 7.644 | 7.956 | 7.722 | 7.878 | 170 | 230 | 800 | 1150 |
| 7.9 | 7.742 | 8.058 | 7.821 | 7.979 | 170 | 230 | 800 | 1150 |
| 8.0 | 7.840 | 8.160 | 7.920 | 8.080 | 170 | 230 | 800 | 1150 |

ELECTRICAL CHARACTERISTICS (Continued)

● Voltage Chart (XC6216 Series) (Continued)

| PARAMETER | E-0 | | | | E-1 | | E-2 | |
|---------------------------|-----------------------------------|--------|-----------------------------------|--------|--|------|---|------|
| NOMINAL OUTPUT VOLTAGE(V) | OUTPUT VOLTAGE (V) 2% ACCURACY | | OUTPUT VOLTAGE (V) 1% ACCURACY | | DROPOUT VOLTAGE 1 (mV) I _{OUT} =20mA | | DROPOUT VOLTAGE 2 (mV) I _{OUT} =100mA | |
| V _{OUT(T)} | V _{OUT(E)} | | V _{OUT(E)} | | V _{dif1} | | V _{dif2} | |
| | MIN. | MAX. | MIN. | MAX. | TYP. | MAX. | TYP. | MAX. |
| 8.1 | 7.938 | 8.262 | 8.019 | 8.181 | 130 | 190 | 700 | 950 |
| 8.2 | 8.036 | 8.364 | 8.118 | 8.282 | 130 | 190 | 700 | 950 |
| 8.3 | 8.134 | 8.466 | 8.217 | 8.383 | 130 | 190 | 700 | 950 |
| 8.4 | 8.232 | 8.568 | 8.316 | 8.484 | 130 | 190 | 700 | 950 |
| 8.5 | 8.330 | 8.670 | 8.415 | 8.585 | 130 | 190 | 700 | 950 |
| 8.6 | 8.428 | 8.772 | 8.514 | 8.686 | 130 | 190 | 700 | 950 |
| 8.7 | 8.526 | 8.874 | 8.613 | 8.787 | 130 | 190 | 700 | 950 |
| 8.8 | 8.624 | 8.976 | 8.712 | 8.888 | 130 | 190 | 700 | 950 |
| 8.9 | 8.722 | 9.078 | 8.811 | 8.989 | 130 | 190 | 700 | 950 |
| 9.0 | 8.820 | 9.180 | 8.910 | 9.090 | 130 | 190 | 700 | 950 |
| 9.1 | 8.918 | 9.282 | 9.009 | 9.191 | 130 | 190 | 700 | 950 |
| 9.2 | 9.016 | 9.384 | 9.108 | 9.292 | 130 | 190 | 700 | 950 |
| 9.3 | 9.114 | 9.486 | 9.207 | 9.393 | 130 | 190 | 700 | 950 |
| 9.4 | 9.212 | 9.588 | 9.306 | 9.494 | 130 | 190 | 700 | 950 |
| 9.5 | 9.310 | 9.690 | 9.405 | 9.595 | 130 | 190 | 700 | 950 |
| 9.6 | 9.408 | 9.792 | 9.504 | 9.696 | 130 | 190 | 700 | 950 |
| 9.7 | 9.506 | 9.894 | 9.603 | 9.797 | 130 | 190 | 700 | 950 |
| 9.8 | 9.604 | 9.996 | 9.702 | 9.898 | 130 | 190 | 700 | 950 |
| 9.9 | 9.702 | 10.098 | 9.801 | 9.999 | 130 | 190 | 700 | 950 |
| 10.0 | 9.800 | 10.200 | 9.900 | 10.100 | 130 | 190 | 700 | 950 |
| 10.1 | 9.898 | 10.302 | 9.999 | 10.201 | 120 | 160 | 650 | 850 |
| 10.2 | 9.996 | 10.404 | 10.098 | 10.302 | 120 | 160 | 650 | 850 |
| 10.3 | 10.094 | 10.506 | 10.197 | 10.403 | 120 | 160 | 650 | 850 |
| 10.4 | 10.192 | 10.608 | 10.296 | 10.504 | 120 | 160 | 650 | 850 |
| 10.5 | 10.290 | 10.710 | 10.395 | 10.605 | 120 | 160 | 650 | 850 |
| 10.6 | 10.388 | 10.812 | 10.494 | 10.706 | 120 | 160 | 650 | 850 |
| 10.7 | 10.486 | 10.914 | 10.593 | 10.807 | 120 | 160 | 650 | 850 |
| 10.8 | 10.584 | 11.016 | 10.692 | 10.908 | 120 | 160 | 650 | 850 |
| 10.9 | 10.682 | 11.118 | 10.791 | 11.009 | 120 | 160 | 650 | 850 |
| 11.0 | 10.780 | 11.220 | 10.890 | 11.110 | 120 | 160 | 650 | 850 |
| 11.1 | 10.878 | 11.322 | 10.989 | 11.211 | 120 | 160 | 650 | 850 |
| 11.2 | 10.976 | 11.424 | 11.088 | 11.312 | 120 | 160 | 650 | 850 |
| 11.3 | 11.074 | 11.526 | 11.187 | 11.413 | 120 | 160 | 650 | 850 |
| 11.4 | 11.172 | 11.628 | 11.286 | 11.514 | 120 | 160 | 650 | 850 |
| 11.5 | 11.270 | 11.730 | 11.385 | 11.615 | 120 | 160 | 650 | 850 |
| 11.6 | 11.368 | 11.832 | 11.484 | 11.716 | 120 | 160 | 650 | 850 |
| 11.7 | 11.466 | 11.934 | 11.583 | 11.817 | 120 | 160 | 650 | 850 |
| 11.8 | 11.564 | 12.036 | 11.682 | 11.918 | 120 | 160 | 650 | 850 |
| 11.9 | 11.662 | 12.138 | 11.781 | 12.019 | 120 | 160 | 650 | 850 |
| 12.0 | 11.760 | 12.240 | 11.880 | 12.120 | 120 | 160 | 650 | 850 |

■ ELECTRICAL CHARACTERISTICS (Continued)

● XE6216 Series B Type

| PARAMETER | SYMBOL | CONDITIONS | Ta=25°C | | | Ta=-40°C~85°C | | | UNITS | CIRCUIT |
|--|---|---|---------|-----------|-----------|---------------|-------|------|------------------|---------|
| | | | MIN. | TYP. | MAX. | MIN. | TYP. | MAX. | | |
| Output Voltage | $V_{OUT(E)}^{(*)2}$ | $I_{OUT}=20mA, V_{CE}=V_{IN}$ | E-0-1 | | | E-0-2 | | | V | ① |
| Maximum Output Current ^(*) | I_{OUTMAX} | $V_{IN}=V_{OUT(T)}+3.0V, V_{CE}=V_{IN}^{(*)1}$ ($V_{OUT(T)} \geq 3.0V$) | - | - | - | 150 | - | - | mA | ① |
| | | $V_{IN}=V_{OUT(T)}+3.0V, V_{CE}=V_{IN}^{(*)1}$ ($V_{OUT(T)} < 3.0V$) | - | - | - | 100 | - | - | mA | ① |
| Load Regulation ^(*) | ΔV_{OUT} | $V_{CE}=V_{IN}, 1mA \leq I_{OUT} \leq 50mA$ | - | E-1-1 | | - | E-1-2 | | mV | ① |
| Dropout Voltage1 | $V_{dif1}^{(*)3}$ | $I_{OUT}=20mA, V_{CE}=V_{IN}$ | - | E-2-1 | | - | E-2-2 | | mV | ① |
| Dropout Voltage2 ^(*) | $V_{dif2}^{(*)3}$ | $I_{OUT}=100mA, V_{CE}=V_{IN}$ | - | E-3-1 | | - | E-3-2 | | mV | ① |
| Supply Current | I_{SS} | $V_{CE}=V_{IN}$ | 1 | 5 | 9 | 0.5 | 5 | 10 | μA | ② |
| Stand-by Current | I_{STB} | $V_{CE}=V_{SS}$ | - | 0.01 | 0.1 | - | 0.01 | 4 | μA | ② |
| Line Regulation1 ^(*) | $\frac{\Delta V_{OUT}}{(\Delta V_{IN} \cdot V_{OUT})}$ | $V_{OUT(T)}+2.0V \leq V_{IN} \leq 28.0V^{(*)1}$ $I_{OUT}=5mA, V_{CE}=V_{IN}$ | - | 0.05 | 0.10 | - | 0.05 | 0.12 | %/V | ① |
| Line Regulation2 ^(*) | $\frac{\Delta V_{OUT}}{(\Delta V_{IN} \cdot V_{OUT})}$ | $V_{OUT(T)}+2.0V \leq V_{IN} \leq 28.0V^{(*)1}$ $I_{OUT}=13mA, V_{CE}=V_{IN}$ | - | 0.15 | 0.30 | - | 0.15 | 0.32 | %/V | ① |
| Input Voltage | V_{IN} | | 2.0 | | 28.0 | 2.0 | | 28.0 | V | |
| Output Voltage Temperature Characteristics | $\frac{\Delta V_{OUT}}{(\Delta T_{opr} \cdot V_{OUT})}$ | $I_{OUT}=20mA, V_{CE}=V_{IN}$ $-40^{\circ}C \leq T_{opr} \leq 85^{\circ}C$ | - | ± 100 | ± 350 | - | - | - | ppm/ $^{\circ}C$ | ① |
| Power Supply Rejection Ratio | PSRR | $V_{IN}=[V_{OUT(T)}+2.0]V+0.5V_{p-pAC}^{(*)1}$ $I_{OUT}=20mA, f=1kHz, V_{CE}=V_{IN}$ | - | 30 | - | - | 30 | - | dB | ③ |
| Short Current | I_{SHORT} | $V_{CE}=V_{IN}$ | - | 30 | - | - | 30 | - | mA | ① |
| CE "H" Level Voltage | V_{CEH} | - | - | - | - | 1.1 | - | 28.0 | V | ① |
| CE "L" Level Voltage | V_{CEL} | - | - | - | - | 0 | - | 0.35 | V | ① |
| CE "H" Level Current | I_{CEH} | $V_{IN}=V_{CE}=28.0V$ | -0.1 | - | 0.1 | -0.1 | - | 0.7 | μA | ② |
| CE "L" Level Current | I_{CEL} | $V_{IN}=28.0V, V_{CE}=V_{SS}$ | -0.1 | - | 0.1 | -0.2 | - | -0.2 | μA | ② |
| Thermal Shutdown Detect Temperature | T_{TSD} | $V_{CE}=V_{IN}$, Junction Temperature | - | 150 | - | - | 150 | - | $^{\circ}C$ | ① |
| Thermal Shutdown Release Temperature | T_{TSR} | $V_{CE}=V_{IN}$, Junction Temperature | - | 125 | - | - | 125 | - | $^{\circ}C$ | ① |
| Hysteresis Width | $T_{TSD} - T_{TSR}$ | $V_{CE}=V_{IN}$, Junction Temperature | - | 25 | - | - | 25 | - | $^{\circ}C$ | - |

Unless otherwise stated, $V_{IN}=V_{OUT(T)}+2.0V$.

NOTE:

*1: $V_{OUT(T)}$: Nominal output voltage

*2: $V_{OUT(E)}$: Effective output voltage

(i.e. the output voltage when " $V_{OUT(T)}+2.0V$ " is provided at the V_{IN} pin while maintaining a certain I_{OUT} value.)

*3: $V_{dif}=\{V_{IN1} - V_{OUT1}\}$

V_{OUT1} : $V_{OUT(T)} < 3.0V$, A voltage equal to 98% of the output voltage whenever an amply stabilized $I_{OUT}\{V_{OUT(T)}+3.0V\}$ is input.

$V_{OUT(T)} \geq 3.0V$, A voltage equal to 98% of the output voltage whenever an amply stabilized $I_{OUT}\{V_{OUT(T)}+2.0V\}$ is input.

V_{IN1} : The input voltage when V_{OUT1} appears as input voltage is gradually decreased.

(*) Junction temperature range is $T_J=-40 \sim 125^{\circ}C$ for this table.

■ ELECTRICAL CHARACTERISTICS (Continued)

● Voltage Chart 1 (XE6216 Series)

| MBOL | E-0-1 | | E-0-2 | |
|---------------------------|------------------------------------|-------|--|-------|
| Temperature / Ta | 25°C | | -40~85°C | |
| PARAMETER | OUTPUT VOLTAGE (V) Accuracy ±2% | | OUTPUT VOLTAGE (V) Accuracy +3% , -3.5% | |
| NOMINAL OUTPUT VOLTAGE(V) | V _{OUT(E)} | | V _{OUT(E)} | |
| V _{OUT(T)} | MIN. | MAX. | MIN. | MAX. |
| 2.0 | 1.960 | 2.040 | 1.930 | 2.060 |
| 2.1 | 2.058 | 2.142 | 2.027 | 2.163 |
| 2.2 | 2.156 | 2.244 | 2.123 | 2.266 |
| 2.3 | 2.254 | 2.346 | 2.220 | 2.369 |
| 2.4 | 2.352 | 2.448 | 2.316 | 2.472 |
| 2.5 | 2.450 | 2.550 | 2.413 | 2.575 |
| 2.6 | 2.548 | 2.652 | 2.509 | 2.678 |
| 2.7 | 2.646 | 2.754 | 2.606 | 2.781 |
| 2.8 | 2.744 | 2.856 | 2.702 | 2.884 |
| 2.9 | 2.842 | 2.958 | 2.799 | 2.987 |
| 3.0 | 2.940 | 3.060 | 2.895 | 3.090 |
| 3.1 | 3.038 | 3.162 | 2.992 | 3.193 |
| 3.2 | 3.136 | 3.264 | 3.088 | 3.296 |
| 3.3 | 3.234 | 3.366 | 3.185 | 3.399 |
| 3.4 | 3.332 | 3.468 | 3.281 | 3.502 |
| 3.5 | 3.430 | 3.570 | 3.378 | 3.605 |
| 3.6 | 3.528 | 3.672 | 3.474 | 3.708 |
| 3.7 | 3.626 | 3.774 | 3.571 | 3.811 |
| 3.8 | 3.724 | 3.876 | 3.667 | 3.914 |
| 3.9 | 3.822 | 3.978 | 3.764 | 4.017 |
| 4.0 | 3.920 | 4.080 | 3.860 | 4.120 |
| 4.1 | 4.018 | 4.182 | 3.957 | 4.223 |
| 4.2 | 4.116 | 4.284 | 4.053 | 4.326 |
| 4.3 | 4.214 | 4.386 | 4.150 | 4.429 |
| 4.4 | 4.312 | 4.488 | 4.246 | 4.532 |
| 4.5 | 4.410 | 4.590 | 4.342 | 4.635 |
| 4.6 | 4.508 | 4.692 | 4.439 | 4.738 |
| 4.7 | 4.606 | 4.794 | 4.535 | 4.841 |
| 4.8 | 4.704 | 4.896 | 4.632 | 4.944 |
| 4.9 | 4.802 | 4.998 | 4.728 | 5.047 |

| SYMBOL | E-0-1 | | E-0-2 | |
|---------------------------|------------------------------------|-------|--|-------|
| Temperature / Ta | 25°C | | -40~85°C | |
| PARAMETER | OUTPUT VOLTAGE (V) Accuracy ±2% | | OUTPUT VOLTAGE (V) Accuracy +3% , -3.5% | |
| NOMINAL OUTPUT VOLTAGE(V) | V _{OUT(E)} | | V _{OUT(E)} | |
| V _{OUT(T)} | MIN. | MAX. | MIN. | MAX. |
| 5.0 | 4.900 | 5.100 | 4.825 | 5.150 |
| 5.1 | 4.998 | 5.202 | 4.921 | 5.253 |
| 5.2 | 5.096 | 5.304 | 5.018 | 5.356 |
| 5.3 | 5.194 | 5.406 | 5.114 | 5.459 |
| 5.4 | 5.292 | 5.508 | 5.211 | 5.562 |
| 5.5 | 5.390 | 5.610 | 5.307 | 5.665 |
| 5.6 | 5.488 | 5.712 | 5.404 | 5.768 |
| 5.7 | 5.586 | 5.814 | 5.500 | 5.871 |
| 5.8 | 5.684 | 5.916 | 5.597 | 5.974 |
| 5.9 | 5.782 | 6.018 | 5.693 | 6.077 |
| 6.0 | 5.880 | 6.120 | 5.790 | 6.180 |
| 6.1 | 5.978 | 6.222 | 5.886 | 6.283 |
| 6.2 | 6.076 | 6.324 | 5.983 | 6.386 |
| 6.3 | 6.174 | 6.426 | 6.079 | 6.489 |
| 6.4 | 6.272 | 6.528 | 6.176 | 6.592 |
| 6.5 | 6.370 | 6.630 | 6.272 | 6.695 |
| 6.6 | 6.468 | 6.732 | 6.369 | 6.798 |
| 6.7 | 6.566 | 6.834 | 6.465 | 6.901 |
| 6.8 | 6.664 | 6.936 | 6.562 | 7.004 |
| 6.9 | 6.762 | 7.038 | 6.658 | 7.107 |
| 7.0 | 6.860 | 7.140 | 6.755 | 7.210 |
| 7.1 | 6.958 | 7.242 | 6.851 | 7.313 |
| 7.2 | 7.056 | 7.344 | 6.948 | 7.416 |
| 7.3 | 7.154 | 7.446 | 7.044 | 7.519 |
| 7.4 | 7.252 | 7.548 | 7.141 | 7.622 |
| 7.5 | 7.350 | 7.650 | 7.237 | 7.725 |
| 7.6 | 7.448 | 7.752 | 7.334 | 7.828 |
| 7.7 | 7.546 | 7.854 | 7.430 | 7.931 |
| 7.8 | 7.644 | 7.956 | 7.527 | 8.034 |
| 7.9 | 7.742 | 8.058 | 7.623 | 8.137 |

■ ELECTRICAL CHARACTERISTICS (Continued)

● Voltage Chart 2 (XE6216 Series)

| SYMBOL | E-0-1 | | E-0-2 | |
|---------------------------|--|--------|--|--------|
| Temperature /Ta | 25°C | | -40~85°C | |
| PARAMETER | OUTPUT VOLTAGE (V) Accuracy $\pm 2\%$ | | OUTPUT VOLTAGE (V) Accuracy +3% , -3.5% | |
| NOMINAL OUTPUT VOLTAGE(V) | V _{OUT(E)} | | V _{OUT(E)} | |
| V _{OUT(T)} | MIN. | MAX. | MIN. | MAX. |
| 8.0 | 7.840 | 8.160 | 7.720 | 8.240 |
| 8.1 | 7.938 | 8.262 | 7.816 | 8.343 |
| 8.2 | 8.036 | 8.364 | 7.913 | 8.446 |
| 8.3 | 8.134 | 8.466 | 8.009 | 8.549 |
| 8.4 | 8.232 | 8.568 | 8.106 | 8.652 |
| 8.5 | 8.330 | 8.670 | 8.202 | 8.755 |
| 8.6 | 8.428 | 8.772 | 8.299 | 8.858 |
| 8.7 | 8.526 | 8.874 | 8.395 | 8.961 |
| 8.8 | 8.624 | 8.976 | 8.492 | 9.064 |
| 8.9 | 8.722 | 9.078 | 8.588 | 9.167 |
| 9.0 | 8.820 | 9.180 | 8.685 | 9.270 |
| 9.1 | 8.918 | 9.282 | 8.781 | 9.373 |
| 9.2 | 9.016 | 9.384 | 8.878 | 9.476 |
| 9.3 | 9.114 | 9.486 | 8.974 | 9.579 |
| 9.4 | 9.212 | 9.588 | 9.071 | 9.682 |
| 9.5 | 9.310 | 9.690 | 9.167 | 9.785 |
| 9.6 | 9.408 | 9.792 | 9.264 | 9.888 |
| 9.7 | 9.506 | 9.894 | 9.360 | 9.991 |
| 9.8 | 9.604 | 9.996 | 9.457 | 10.094 |
| 9.9 | 9.702 | 10.098 | 9.553 | 10.197 |
| 10.0 | 9.800 | 10.200 | 9.650 | 10.300 |
| 10.1 | 9.898 | 10.302 | 9.747 | 10.403 |
| 10.2 | 9.996 | 10.404 | 9.843 | 10.506 |
| 10.3 | 10.094 | 10.506 | 9.940 | 10.609 |
| 10.4 | 10.192 | 10.608 | 10.036 | 10.712 |
| 10.5 | 10.290 | 10.710 | 10.133 | 10.815 |
| 10.6 | 10.388 | 10.812 | 10.229 | 10.918 |
| 10.7 | 10.486 | 10.914 | 10.326 | 11.021 |
| 10.8 | 10.584 | 11.016 | 10.422 | 11.124 |
| 10.9 | 10.682 | 11.118 | 10.519 | 11.227 |
| 11.0 | 10.780 | 11.220 | 10.615 | 11.330 |
| 11.1 | 10.878 | 11.322 | 10.712 | 11.433 |
| 11.2 | 10.976 | 11.424 | 10.808 | 11.536 |
| 11.3 | 11.074 | 11.526 | 10.905 | 11.639 |
| 11.4 | 11.172 | 11.628 | 11.001 | 11.742 |
| 11.5 | 11.270 | 11.730 | 11.098 | 11.845 |
| 11.6 | 11.368 | 11.832 | 11.194 | 11.948 |
| 11.7 | 11.466 | 11.934 | 11.291 | 12.051 |
| 11.8 | 11.564 | 12.036 | 11.387 | 12.154 |
| 11.9 | 11.662 | 12.138 | 11.484 | 12.257 |
| 12.0 | 11.760 | 12.240 | 11.580 | 12.360 |

■ ELECTRICAL CHARACTERISTICS (Continued)

● Voltage Chart 3 (XE6216 Series)

| SYMBOL | E-1-1 | | E-1-2 | | E-2-1 | | E-2-2 | | E-3-1 | | E-3-2 | |
|---------------------------|----------------------|------|----------------------|------|--|------|--|------|---|------|---|------|
| Temperature /Ta | 25°C | | -40~85°C | | 25°C | | -40~85°C | | 25°C | | -40~85°C | |
| PARAMETER | LOAD REGULATION (mV) | | LOAD REGULATION (mV) | | DROPOUT VOLTAGE 1 (mV) I _{OUT} =20mA | | DROPOUT VOLTAGE 1 (mV) I _{OUT} =20mA | | DROPOUT VOLTAGE 2 (mV) I _{OUT} =100mA | | DROPOUT VOLTAGE 2 (mV) I _{OUT} =100mA | |
| NOMINAL OUTPUT VOLTAGE(V) | ΔV _{OUT} | | ΔV _{OUT} | | Vdif1 | | Vdif1 | | Vdif2 | | Vdif2 | |
| V _{OUT(T)} (V) | TYP. | MAX. | TYP. | MAX. | TYP. | MAX. | TYP. | MAX. | TYP. | MAX. | TYP. | MAX. |
| 2.0 | 50 | 90 | 50 | 103 | 450 | 600 | 450 | 735 | 1900 | 2600 | 1900 | 3060 |
| 2.1 | | | | | 390 | 520 | 390 | 675 | 1700 | 2200 | 1700 | 2760 |
| 2.2 | | | | | 260 | 360 | 260 | 520 | 1300 | 1700 | 1300 | 2370 |
| 2.3 | | | | | | | | | | | | |
| 2.4 | | | | | | | | | | | | |
| 2.5 | | | | | | | | | | | | |
| 2.6 | | | | | | | | | | | | |
| 2.7 | | | | | | | | | | | | |
| 2.8 | | | | | | | | | | | | |
| 2.9 | | | | | | | | | | | | |
| 3.0 | | | | | | | | | | | | |
| 3.1 | | | | | | | | | | | | |
| 3.2 | | | | | | | | | | | | |
| 3.3 | | | | | | | | | | | | |
| 3.4 | | | | | | | | | | | | |
| 3.5 | | | | | | | | | | | | |
| 3.6 | | | | | | | | | | | | |
| 3.7 | | | | | | | | | | | | |
| 3.8 | | | | | | | | | | | | |
| 3.9 | | | | | | | | | | | | |
| 4.0 | 220 | 320 | 220 | 410 | 1100 | 1500 | 1100 | 2045 | | | | |
| 4.1 | | | | | | | | | | | | |
| 4.2 | | | | | | | | | | | | |
| 4.3 | | | | | | | | | | | | |
| 4.4 | | | | | | | | | | | | |
| 4.5 | | | | | | | | | | | | |
| 4.6 | | | | | | | | | | | | |
| 4.7 | | | | | | | | | | | | |
| 4.8 | | | | | | | | | | | | |
| 4.9 | | | | | | | | | | | | |

■ ELECTRICAL CHARACTERISTICS (Continued)

● Voltage Chart 4 (XE6216 Series)

| SYMBOL | E-1-1 | | E-1-2 | | E-2-1 | | E-2-2 | | E-3-1 | | E-3-2 | |
|---------------------------|----------------------|------|----------------------|------|--|------|--|------|---|------|---|------|
| Temperature / Ta | 25°C | | -40~85°C | | 25°C | | -40~85°C | | 25°C | | -40~85°C | |
| PARAMETER | LOAD REGULATION (mV) | | LOAD REGULATION (mV) | | DROPOUT VOLTAGE 1 (mV) I _{OUT} =20mA | | DROPOUT VOLTAGE 1 (mV) I _{OUT} =20mA | | DROPOUT VOLTAGE 2 (mV) I _{OUT} =100mA | | DROPOUT VOLTAGE 2 (mV) I _{OUT} =100mA | |
| NOMINAL OUTPUT VOLTAGE(V) | ΔV _{OUT} | | ΔV _{OUT} | | V _{dif1} | | V _{dif1} | | V _{dif2} | | V _{dif2} | |
| V _{OUT(T)} (V) | TYP. | MAX. | TYP. | MAX. | TYP. | MAX. | TYP. | MAX. | TYP. | MAX. | TYP. | MAX. |
| 5.0 | | | | | | | | | | | | |
| 5.1 | | | | | | | | | | | | |
| 5.2 | | | | | | | | | | | | |
| 5.3 | | | | | | | | | | | | |
| 5.4 | | | | | | | | | | | | |
| 5.5 | | | | | | | | | | | | |
| 5.6 | | | | | | | | | | | | |
| 5.7 | | | | | 190 | 280 | 190 | 380 | 1000 | 1300 | 1000 | 1730 |
| 5.8 | | | | | | | | | | | | |
| 5.9 | | | | | | | | | | | | |
| 6.0 | 50 | 90 | 50 | 103 | | | | | | | | |
| 6.1 | | | | | | | | | | | | |
| 6.2 | | | | | | | | | | | | |
| 6.3 | | | | | | | | | | | | |
| 6.4 | | | | | | | | | | | | |
| 6.5 | | | | | | | | | | | | |
| 6.6 | | | | | | | | | | | | |
| 6.7 | | | | | | | | | | | | |
| 6.8 | | | | | | | | | | | | |
| 6.9 | | | | | | | | | | | | |
| 7.0 | | | | | | | | | | | | |
| 7.1 | | | | | | | | | | | | |
| 7.2 | | | | | 170 | 230 | 170 | 340 | 800 | 1150 | 800 | 1580 |
| 7.3 | | | | | | | | | | | | |
| 7.4 | | | | | | | | | | | | |
| 7.5 | 110 | 140 | 110 | 150 | | | | | | | | |
| 7.6 | | | | | | | | | | | | |
| 7.7 | | | | | | | | | | | | |
| 7.8 | | | | | | | | | | | | |
| 7.9 | | | | | | | | | | | | |
| 8.0 | | | | | | | | | | | | |

ELECTRICAL CHARACTERISTICS (Continued)

● Voltage Chart 5 (XE6216 Series)

| SYMBOL | E-1-1 | | E-1-2 | | E-2-1 | | E-2-2 | | E-3-1 | | E-3-2 | |
|---------------------------|----------------------|------|----------------------|------|--|------|--|------|---|------|---|------|
| Temperature / Ta | 25°C | | -40~85°C | | 25°C | | -40~85°C | | 25°C | | -40~85°C | |
| PARAMETER | LOAD REGULATION (mV) | | LOAD REGULATION (mV) | | DROPOUT VOLTAGE 1 (mV) I _{OUT} =20mA | | DROPOUT VOLTAGE 1 (mV) I _{OUT} =20mA | | DROPOUT VOLTAGE 2 (mV) I _{OUT} =100mA | | DROPOUT VOLTAGE 2 (mV) I _{OUT} =100mA | |
| NOMINAL OUTPUT VOLTAGE(V) | | | | | | | | | | | | |
| V _{OUT(T)} (V) | ΔV _{OUT} | | ΔV _{OUT} | | V _{dif1} | | V _{dif1} | | V _{dif2} | | V _{dif2} | |
| | TYP. | MAX. | TYP. | MAX. | TYP. | MAX. | TYP. | MAX. | TYP. | MAX. | TYP. | MAX. |
| 8.1 | | | | | | | | | | | | |
| 8.2 | | | | | | | | | | | | |
| 8.3 | | | | | | | | | | | | |
| 8.4 | | | | | | | | | | | | |
| 8.5 | | | | | | | | | | | | |
| 8.6 | | | | | | | | | | | | |
| 8.7 | | | | | | | | | | | | |
| 8.8 | | | | | | | | | | | | |
| 8.9 | | | | | | | | | | | | |
| 9.0 | | | | | 130 | 190 | 130 | 320 | 700 | 950 | 700 | 1460 |
| 9.1 | | | | | | | | | | | | |
| 9.2 | | | | | | | | | | | | |
| 9.3 | | | | | | | | | | | | |
| 9.4 | | | | | | | | | | | | |
| 9.5 | | | | | | | | | | | | |
| 9.6 | | | | | | | | | | | | |
| 9.7 | | | | | | | | | | | | |
| 9.8 | | | | | | | | | | | | |
| 9.9 | | | | | | | | | | | | |
| 10.0 | 110 | 140 | 110 | 150 | | | | | | | | |
| 10.1 | | | | | | | | | | | | |
| 10.2 | | | | | | | | | | | | |
| 10.3 | | | | | | | | | | | | |
| 10.4 | | | | | | | | | | | | |
| 10.5 | | | | | | | | | | | | |
| 10.6 | | | | | | | | | | | | |
| 10.7 | | | | | | | | | | | | |
| 10.8 | | | | | | | | | | | | |
| 10.9 | | | | | | | | | | | | |
| 11.0 | | | | | 120 | 160 | 120 | 285 | 650 | 850 | 650 | 1160 |
| 11.1 | | | | | | | | | | | | |
| 11.2 | | | | | | | | | | | | |
| 11.3 | | | | | | | | | | | | |
| 11.4 | | | | | | | | | | | | |
| 11.5 | | | | | | | | | | | | |
| 11.6 | | | | | | | | | | | | |
| 11.7 | | | | | | | | | | | | |
| 11.8 | | | | | | | | | | | | |
| 11.9 | | | | | | | | | | | | |
| 12.0 | | | | | | | | | | | | |

TEST CIRCUITS

Circuit ①

●XC6216B/XE6216B Type

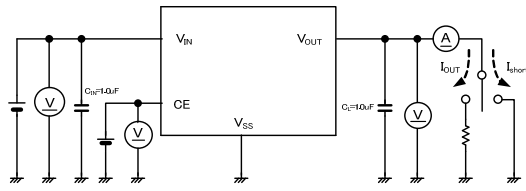

●XC6216C Type

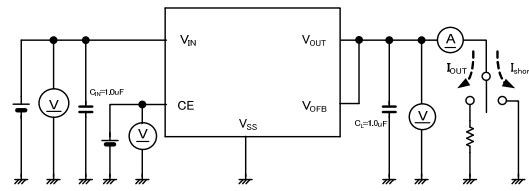

●XC6216D Type

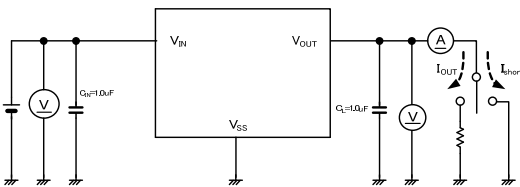

Circuit ②

●XC6216B/XE6216B Type

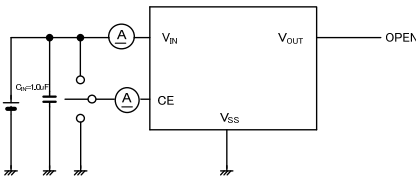

●XC6216C Type

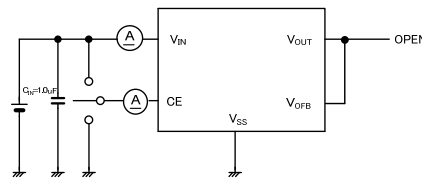

●XC6216D Type

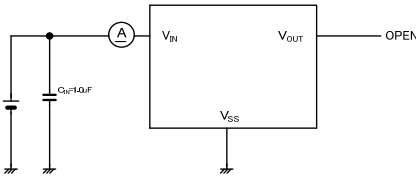

Circuit ③

●XC6216B/XE6216B Type

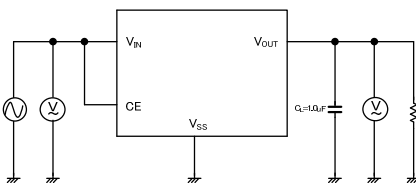

●XC6216C Type

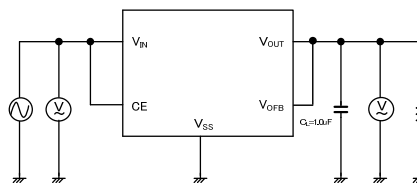

●XC6216D Type

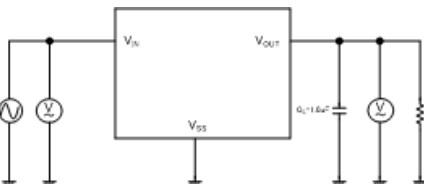

Circuit ④

●XC6216C Type

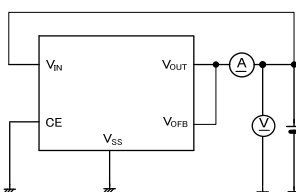

OPERATIONAL EXPLANATION

<Output Voltage Control>

The voltage divided by resistors R11 & R12 is compared with the internal reference voltage by the error amplifier. The P-channel MOSFET which is connected to the V_{OUT} pin is then driven by the subsequent controlled signal. The output voltage at the V_{OUT} pin is controlled and stabilized by a system of negative feedback. The current limit circuit and short protect circuit operate in relation to the level of output current and heat dissipation. Further, the IC's internal circuitry can be shutdown via the CE pin's signal.

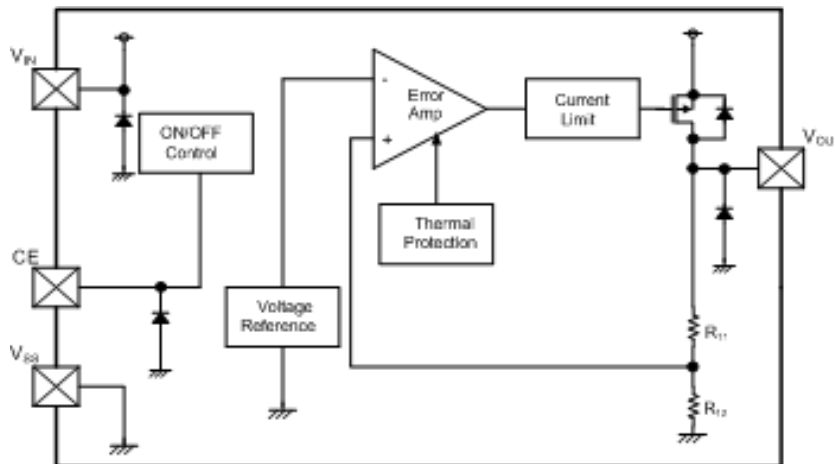

<Short-Circuit Protection>

The XC6216/XE6216 series includes a current fold-back circuit as a short circuit protection. When the load current reaches the current limit level, the current fold-back circuit operates and output voltage drops. The output voltage drops further and output current decreases. When the output pin is shorted, a current of about 30mA flows.

<CE Pin>

The IC's internal circuitry can be shutdown via the signal from the CE pin with the XC6216/XE6216 series. In shutdown mode, output at the V_{OUT} pin will be pulled down by R₁₁ and R₁₂ to the V_{SS} level. Note that as the XC6216/XE6216 series has no pull down resistor so that it will become unstable with the CE pin open. We suggest that you use this IC with either a V_{IN} voltage or a V_{SS} voltage input at the CE pin. If this IC is used with the correct specifications for the CE pin, the operational logic is fixed and the IC will operate normally. However, supply current may increase as a result of through current in the IC's internal circuitry if a medium voltage is applied.

<Thermal Protection>

When the junction temperature of the built-in driver transistor reaches the temperature limit, the thermal shutdown circuit operates and the driver transistor will be set to OFF. The IC resumes its operation when the thermal shutdown function is released and the IC's operation is automatically restored because the junction temperature drops to the level of the thermal shutdown release voltage.

<Minimum Operating Voltage>

For the stable operation of the IC, over 2.0V of input voltage is necessary. The output voltage may not be generated normally if the input voltage is less than 2.0V.

NOTES ON USE

1. Please use this IC within the stated absolute maximum ratings. The IC is liable to malfunction should the ratings be exceeded.
2. Where wiring impedance is high, operations may become unstable due to the noise and/or phase lag depending on output current. Please strengthen V_{IN} and V_{SS} wiring in particular.
3. Phase compensation inside the IC is performed in the XC6216/XE6216 series. Therefore, an abnormal oscillation does not occur even if there is no output capacitor C_L. An input capacitor C_{IN} around 0.1 μ F~1.0 μ F between the power input pin (V_{IN}) and the ground pin (V_{SS}) is required for input stability. Also, the output voltage fluctuation such as under shoot or over shoot, which occurs because of the load change can be controlled by placing the output capacitor C_L around 0.1 μ F~1.0 μ F between the V_{OUT} pin and V_{SS} pin. The input capacitor (C_{IN}) and the output capacitor (C_L) should be placed to the IC as close as possible with a shorter wiring.

NOTES ON USE

4. Notes on setting output voltage externally (C type) Ta=25°C

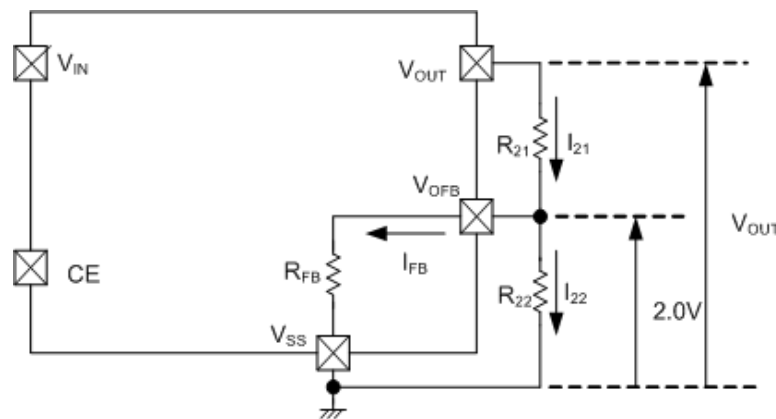

The output voltage can be set externally by the following equation:

$$I_{21} = I_{FB} + I_{22} \quad \dots \dots \dots (1)$$

$$I_{22} = 2.0V / R_{22} \quad \dots \dots \dots (2)$$

$$I_{21} = I_{FB} + 2.0V / R_{22} \quad \dots \dots \dots (3)$$

If the equation (3) is assigned to the equation (2), the equation becomes as below:

$$V_{OUT} = 2.0V + R_{21} \cdot I_{21} \quad \dots \dots \dots (3)$$

For this, the following equation can be used for setting output voltage externally:

$$V_{OUT} = 2.0V + R_{21} \cdot I_{21} \quad \dots \dots \dots (4)$$

And the equation (4) will be;

$$\begin{aligned} V_{OUT} &= 2.0V + R_{21} \cdot (I_{FB} + 2.0V / R_{22}) \quad \dots \dots \dots (5) \\ &= 2.0V \cdot (R_{21} + R_{22}) / R_{22} + R_{21} \cdot I_{FB} \end{aligned}$$

The second term of the equation (6), $R_{21} \cdot I_{FB}$, is the cause of the output accuracy error.

The I_{FB} can be calculated by the following equation:

$$I_{FB} = 2.0V / R_{FB} \quad \dots \dots \dots (6)$$

The cause of the output accuracy error, $R_{21} \cdot I_{FB}$ can be calculated by the equation below;

$$\begin{aligned} R_{21} \cdot I_{FB} &= R_{21} \cdot 2.0V / R_{FB} \quad \dots \dots \dots (7) \\ &= 2.0V \cdot R_{21} / R_{FB} \end{aligned}$$

Accordingly, if $R_{21} \ll R_{FB}$, the output voltage error becomes minute.

● Setting Resistance-Dependant of XC6216 Series C type's Output Voltage

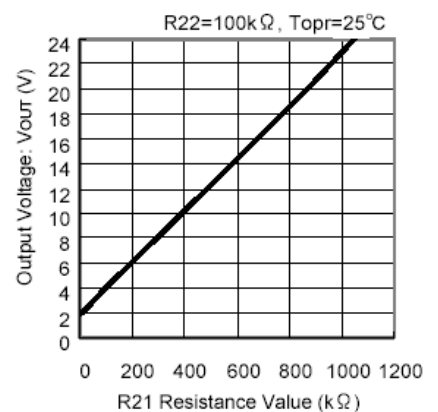
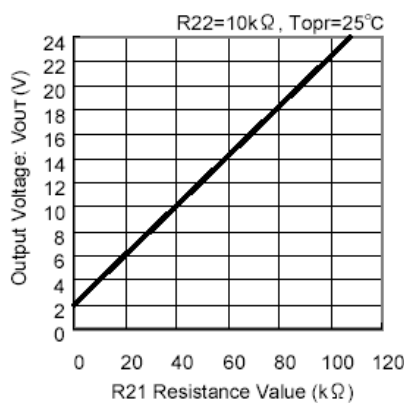
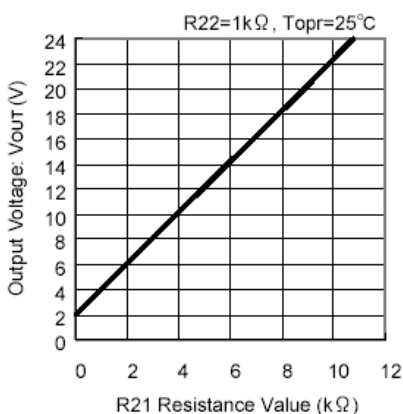

5. Torex places an importance on improving our products and its reliability.

However, by any possibility, we would request user fail-safe design and post-aging treatment on system or equipment.

TYPICAL PERFORMANCE CHARACTERISTICS

(1) Output Voltage vs. Output Current

XC6216B/C/D 202

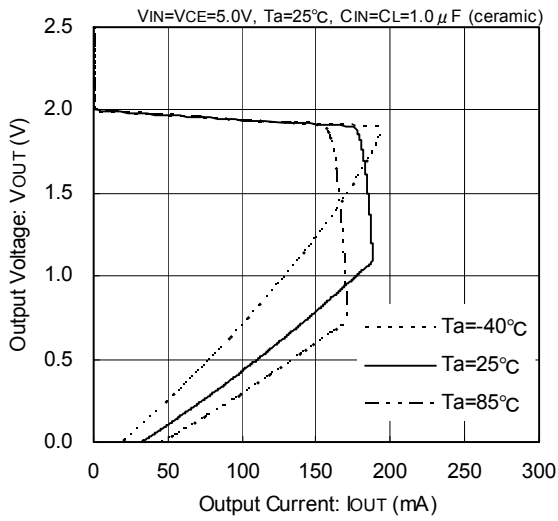

XC6216B/C/D 202

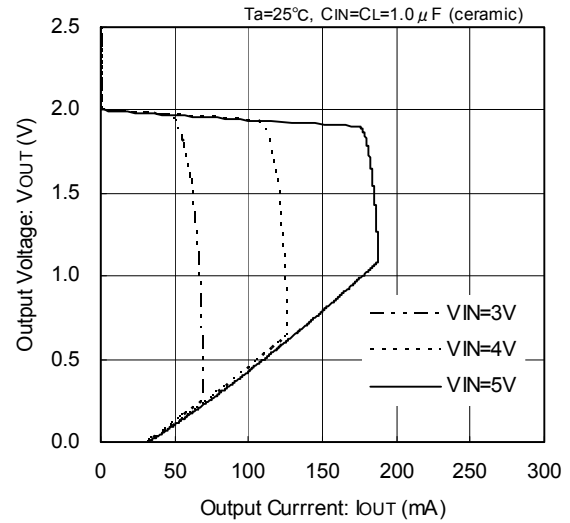

XC6216B/D 332

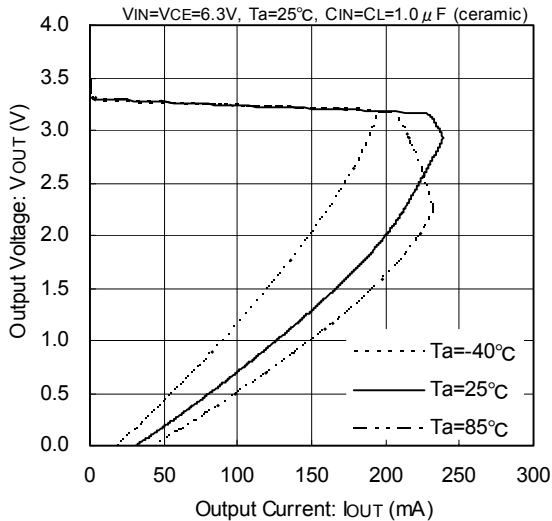

XC6216B/D 332

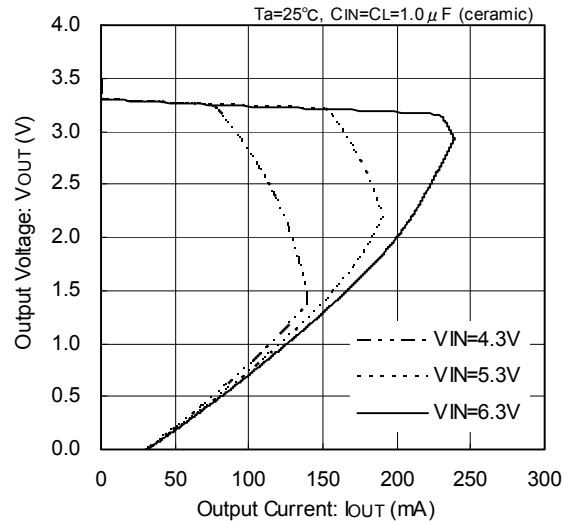

XC6216B/D 502

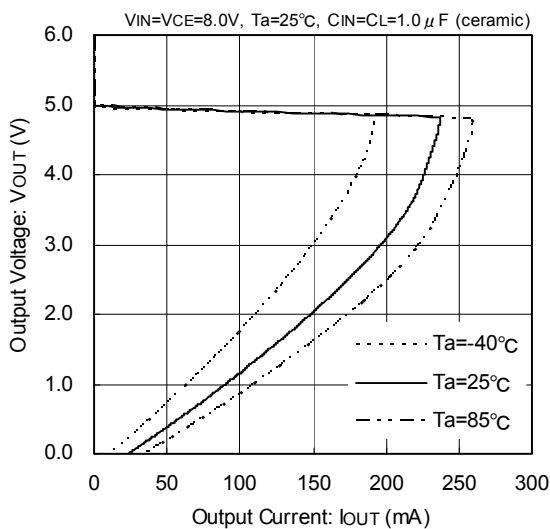

XC6216B/D 502

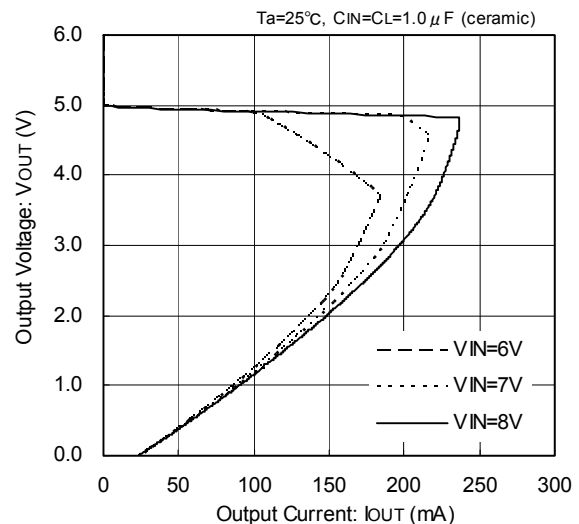

■ TYPICAL PERFORMANCE CHARACTERISTICS (Continued)

(1) Output Voltage vs. Output Current (Continued)

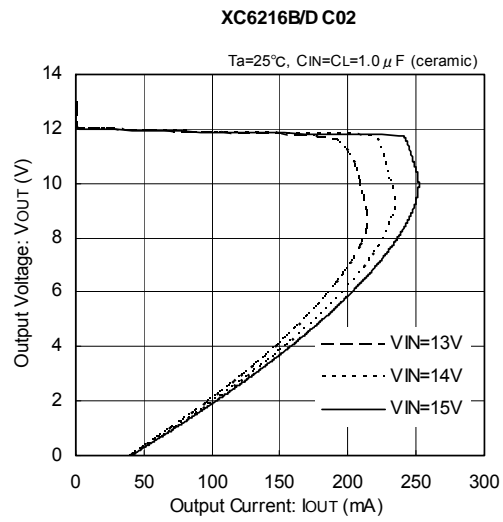
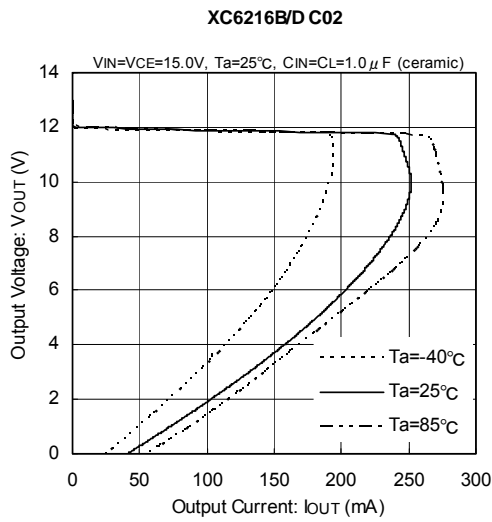

(2) Output Voltage vs. Input Voltage

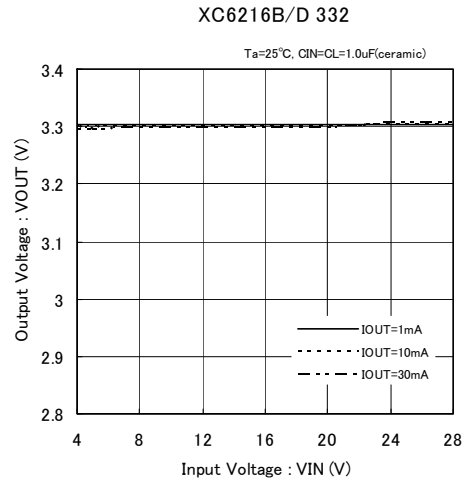
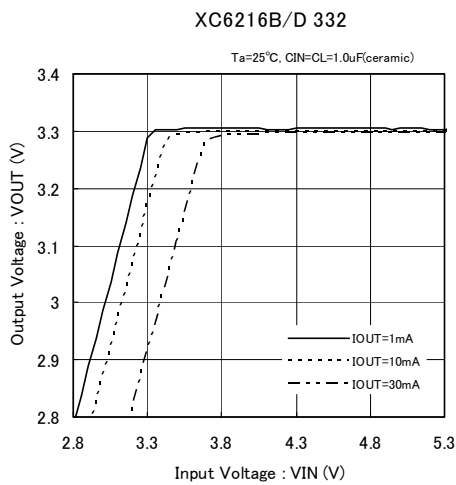
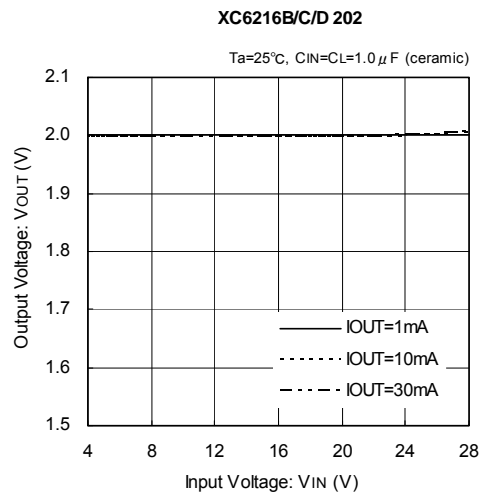
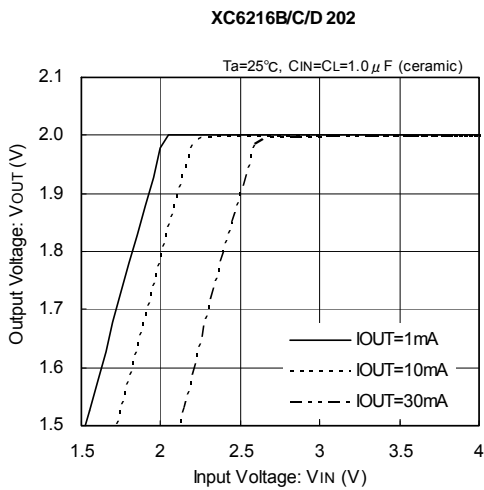

TYPICAL PERFORMANCE CHARACTERISTICS (Continued)

(2) Output Voltage vs. Input Voltage (Continued)

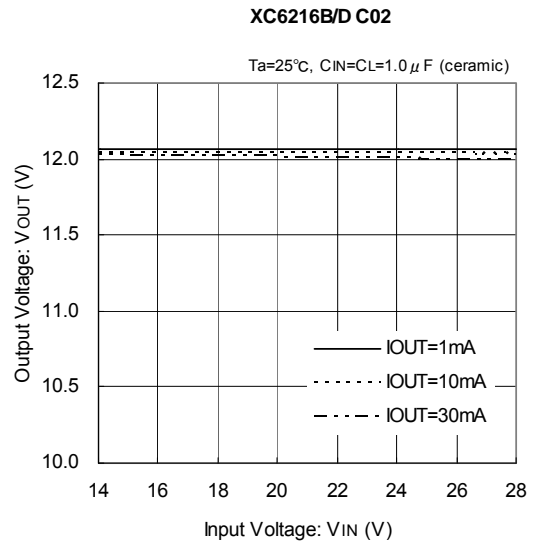
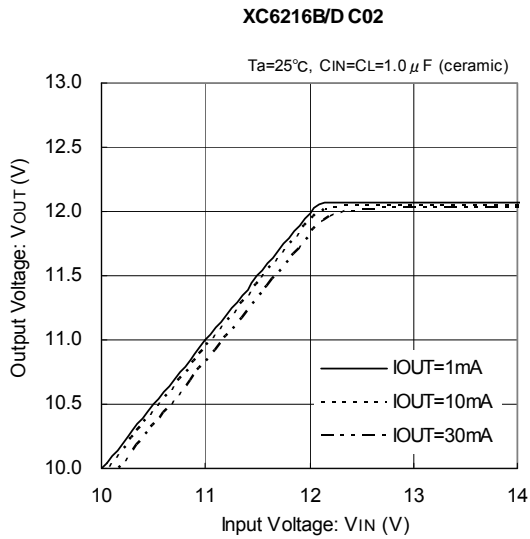
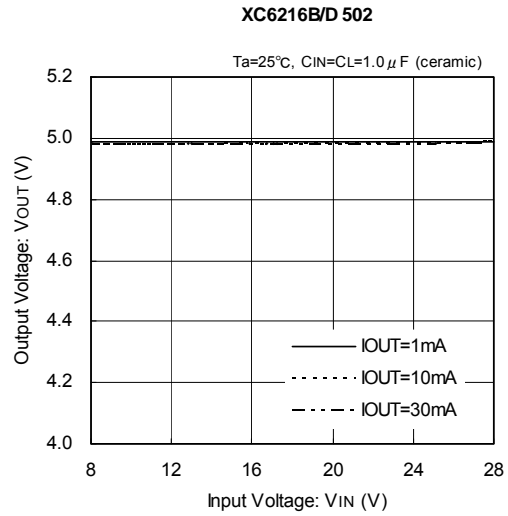
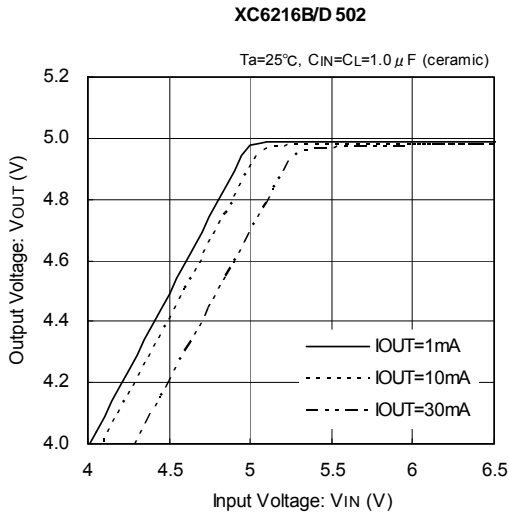

(3) Dropout Voltage vs. Output Current

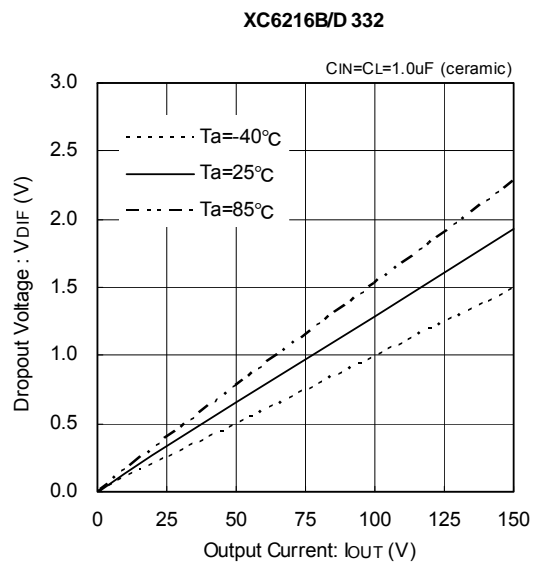
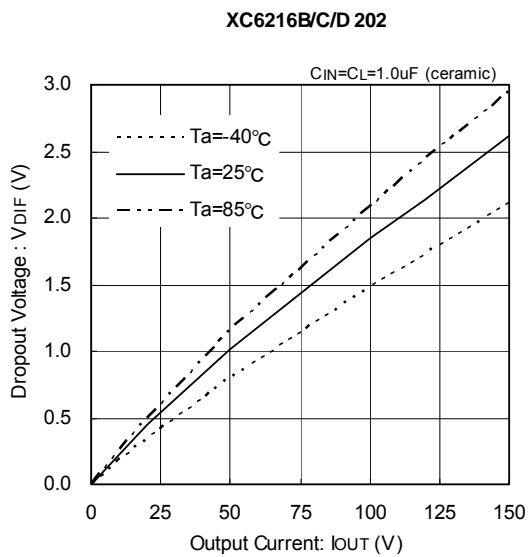

■ TYPICAL PERFORMANCE CHARACTERISTICS (Continued)

(3) Dropout Voltage vs. Output Current

XC6216B/D 502

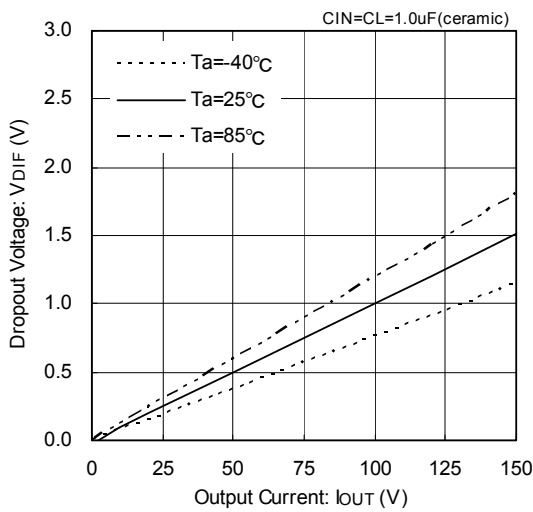

XC6216B/D C02

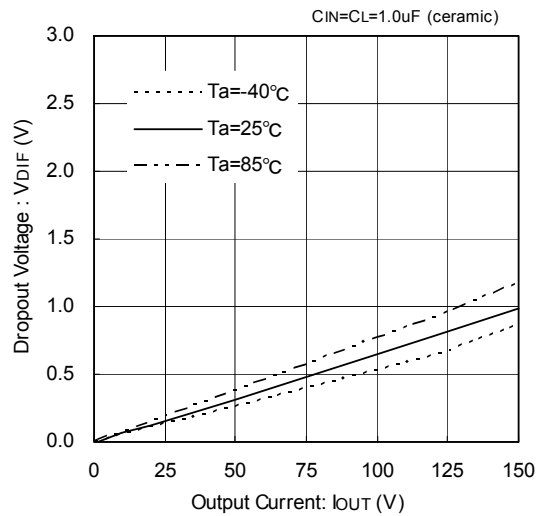

(4) Supply Current vs. Input Voltage

XC6216B/C/D 202

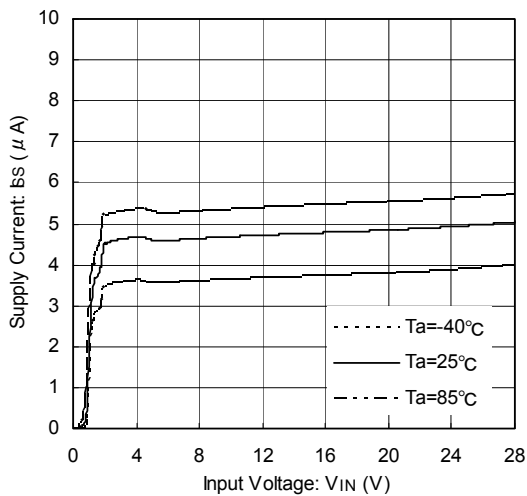

XC6216B/C/D 202

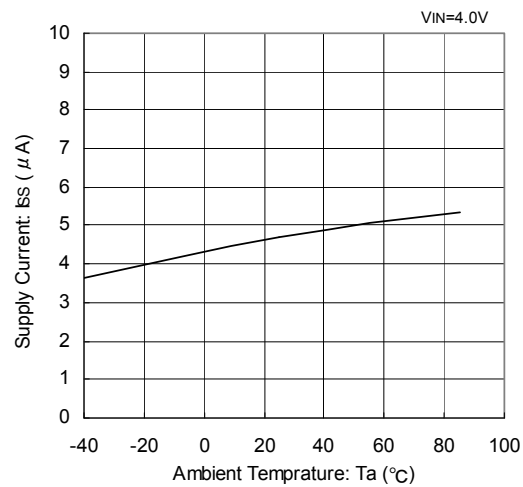

XC6216B/D 332

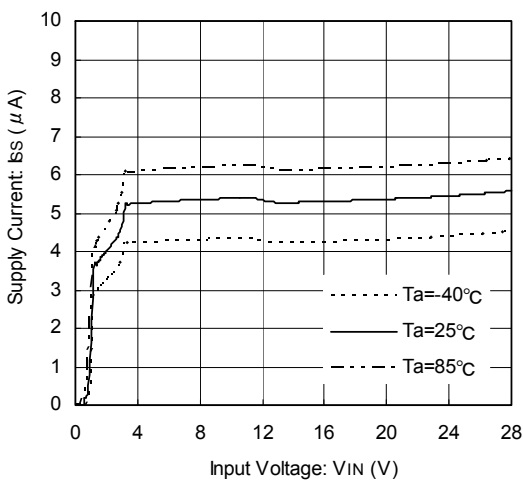

XC6216B/D 332

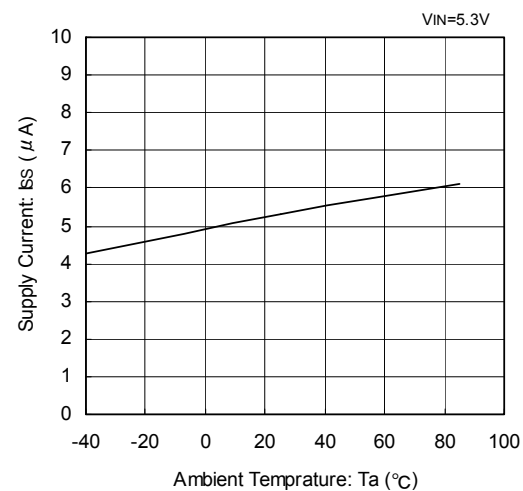

TYPICAL PERFORMANCE CHARACTERISTICS (Continued)

(4) Supply Current vs. Input Voltage (Continued)

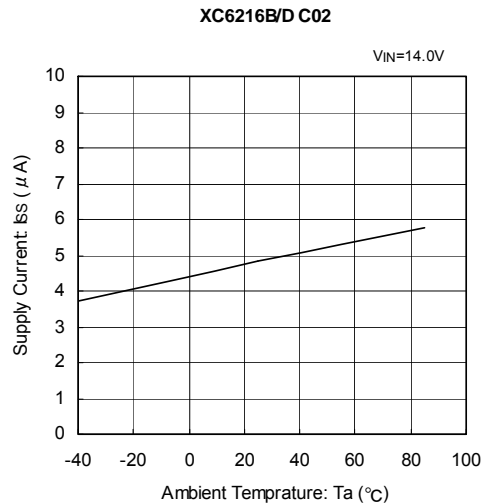
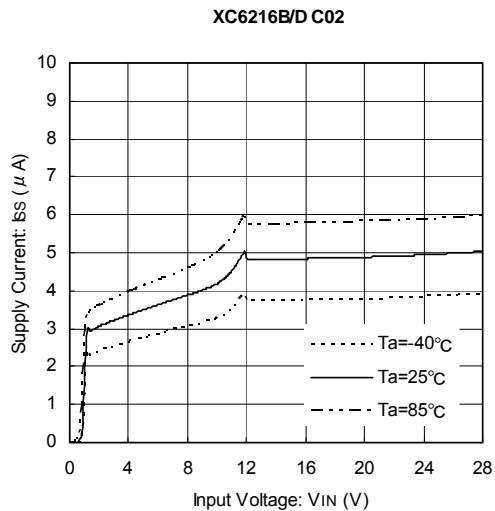
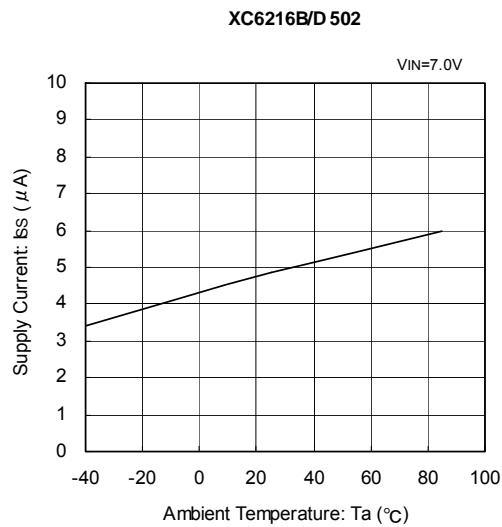
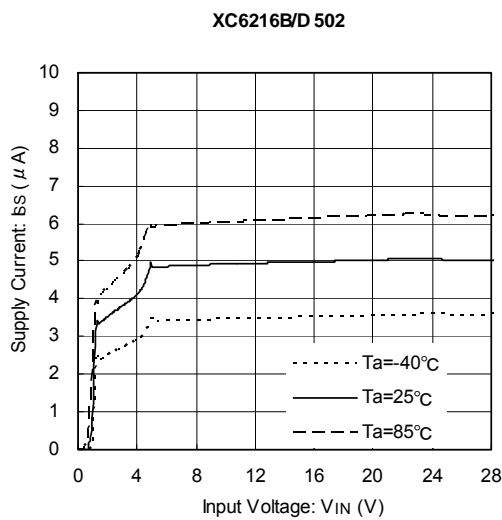

(5) Output Voltage vs. Ambient Temperature

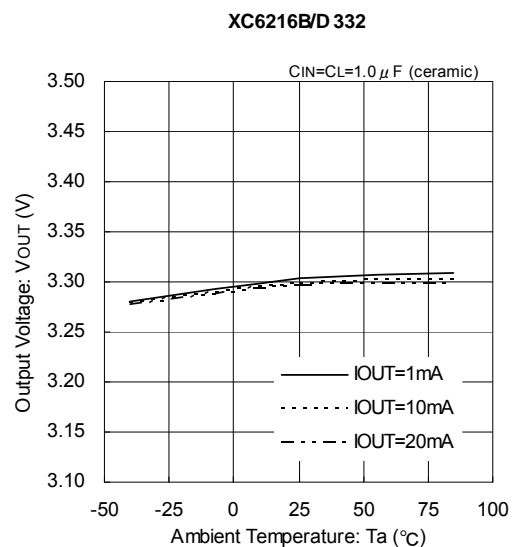
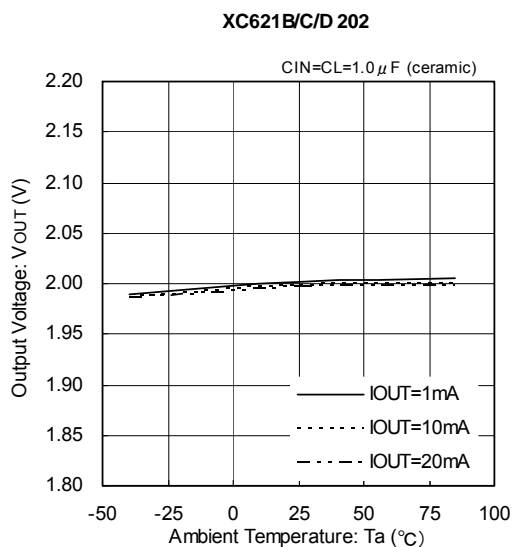

■ TYPICAL PERFORMANCE CHARACTERISTICS (Continued)

(5) Output Voltage vs. Ambient Temperature

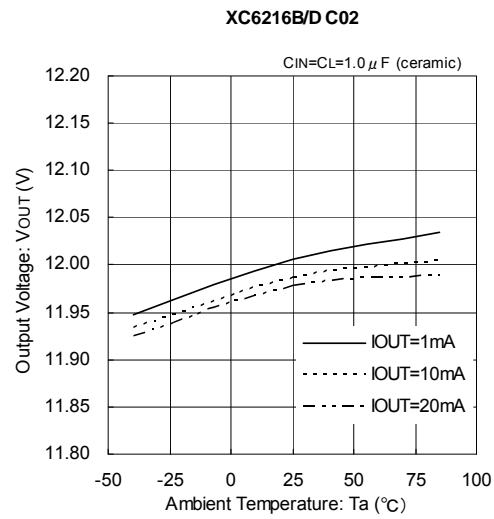
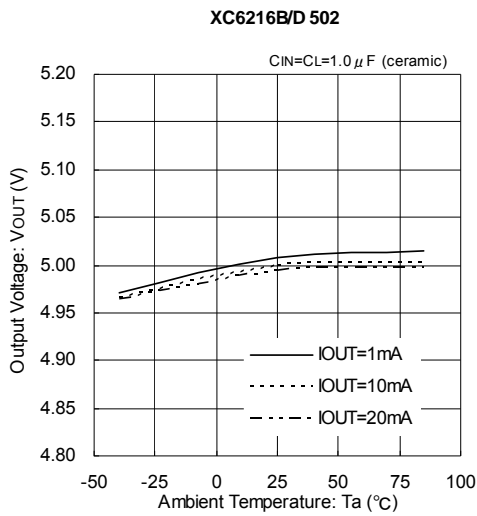

(6) Line Transient Response

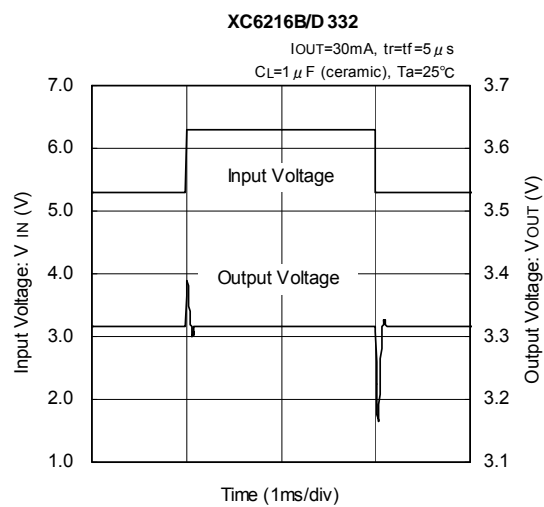
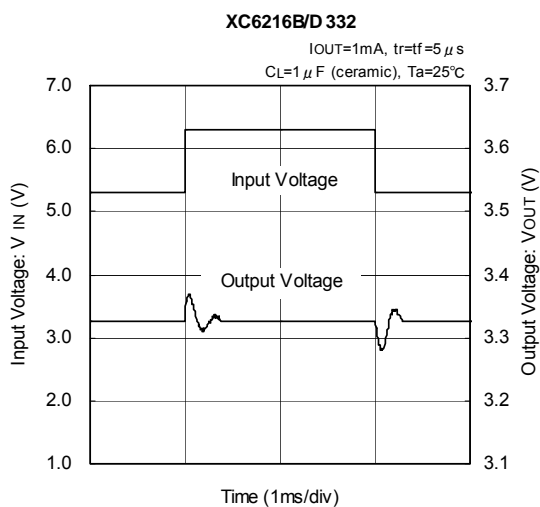
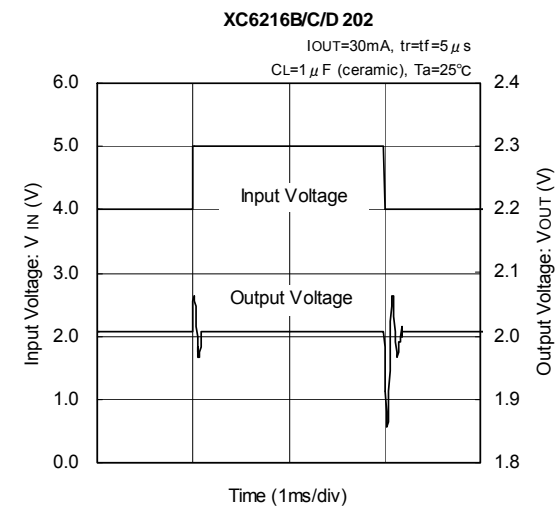
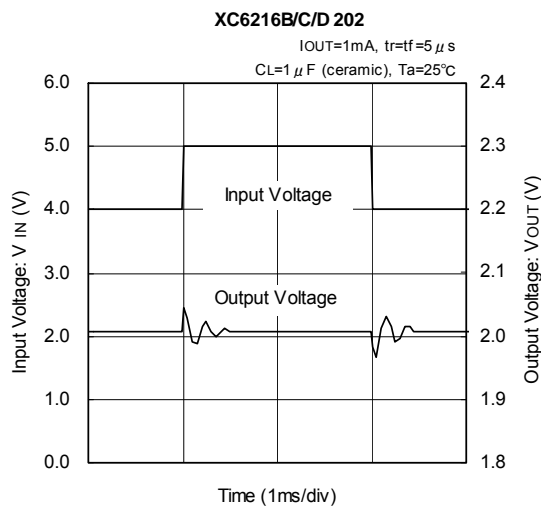

TYPICAL PERFORMANCE CHARACTERISTICS (Continued)

(6) Line Transient Response (Continued)

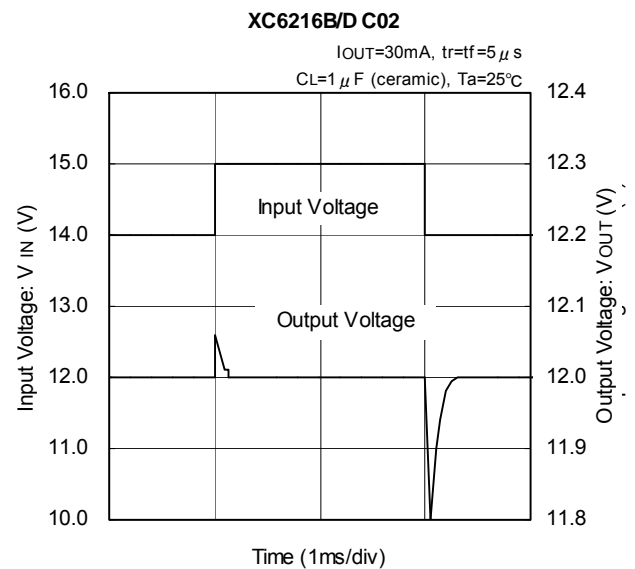
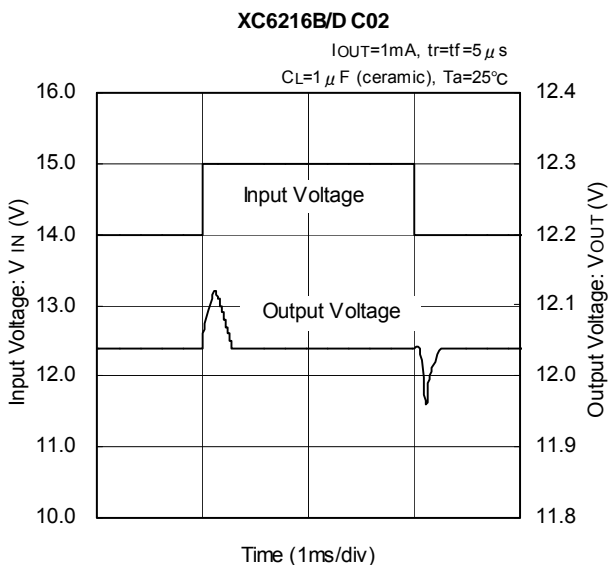
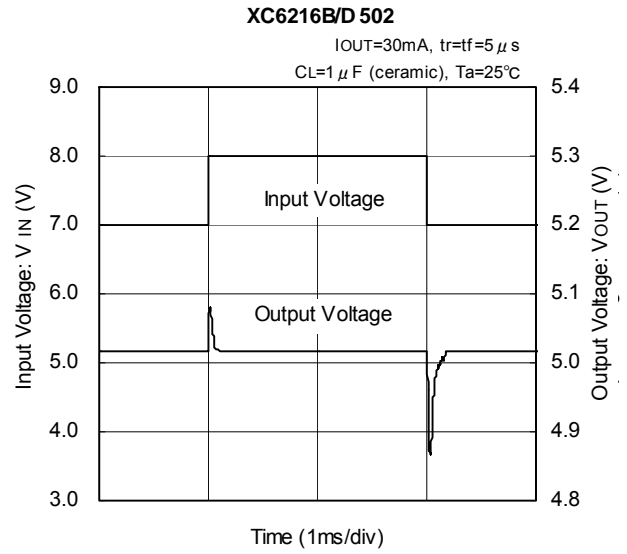
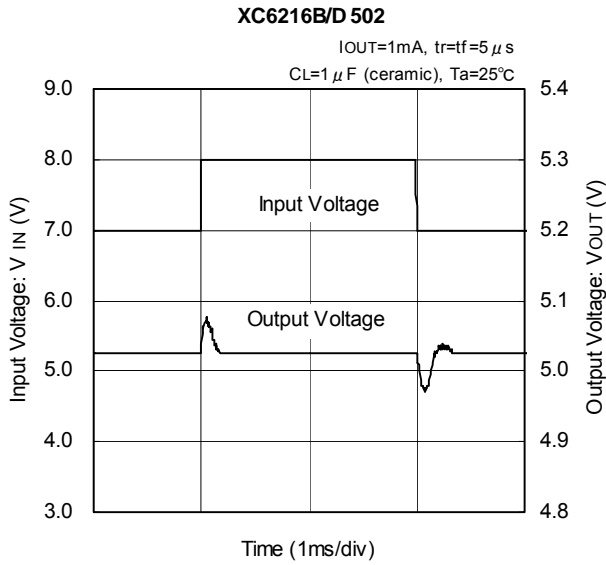

(7) Load Transient Response

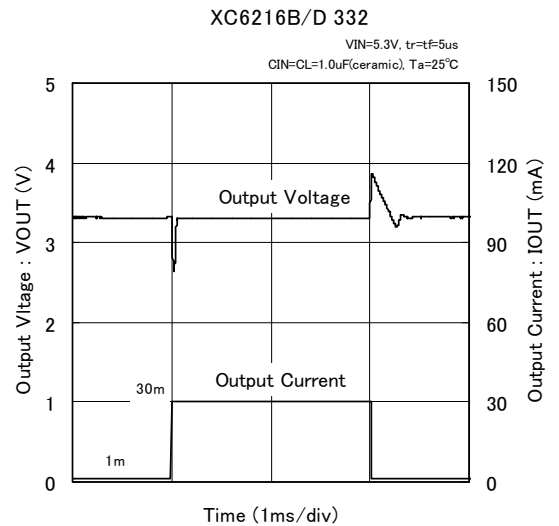
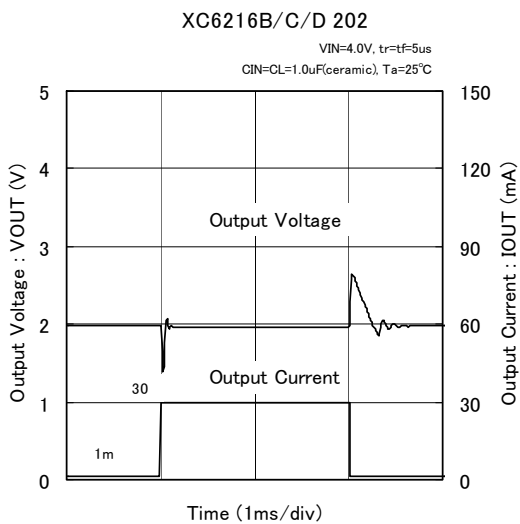

■ TYPICAL PERFORMANCE CHARACTERISTICS (Continued)

(7) Load Transient Response (Continued)

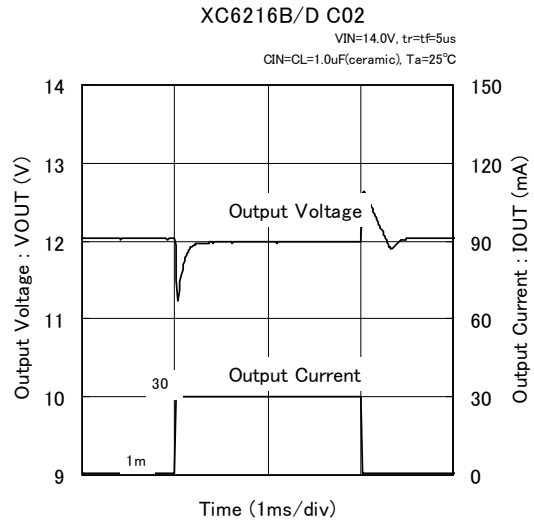
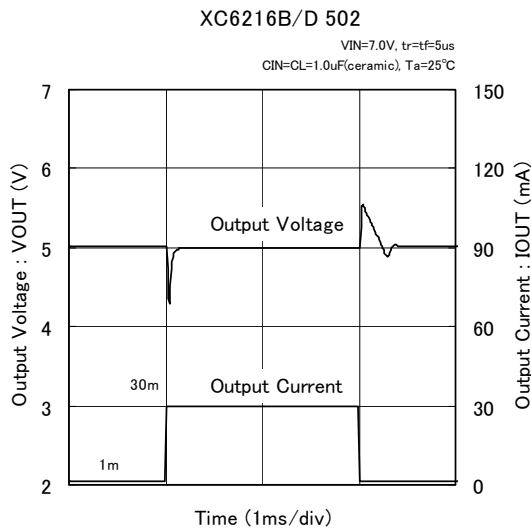

(8) Input Rise Time

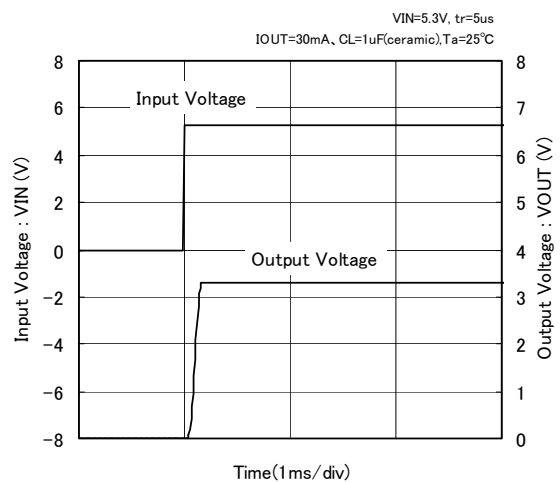
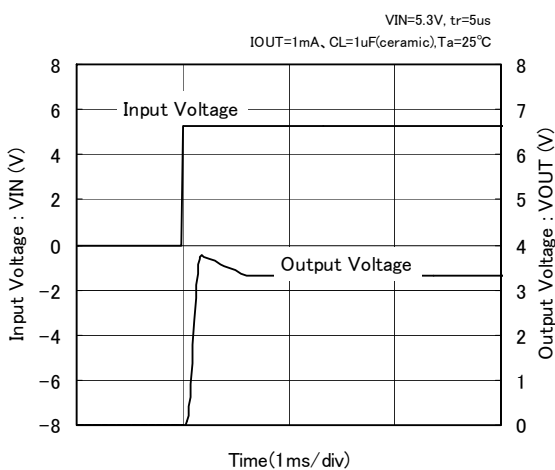
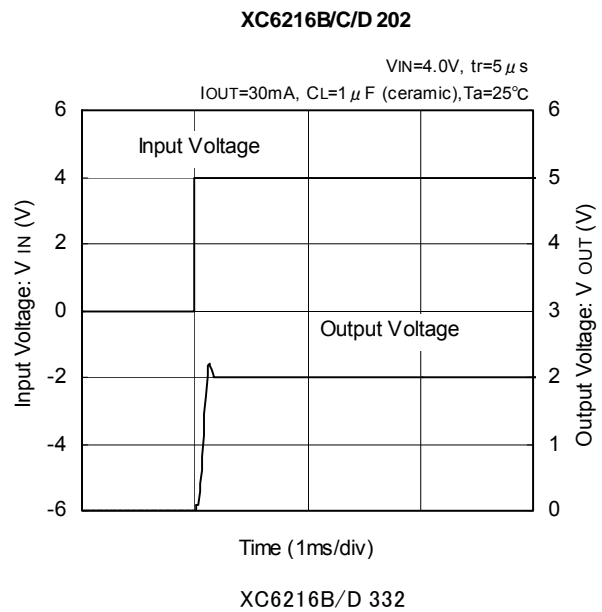
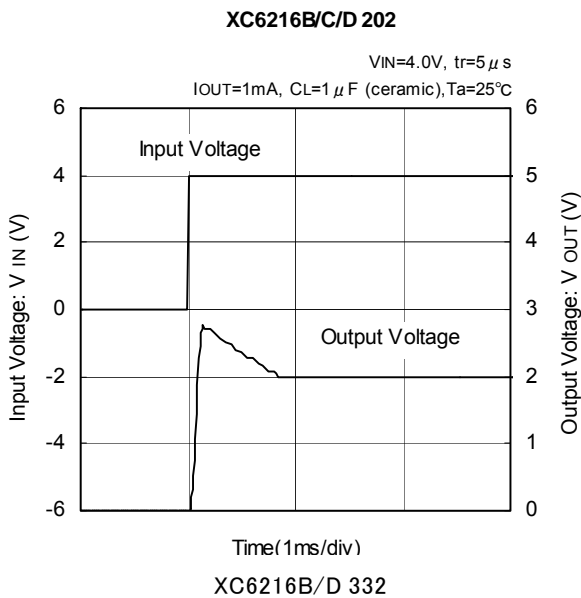

TYPICAL PERFORMANCE CHARACTERISTICS (Continued)

(8) Input Rise Time (Continued)

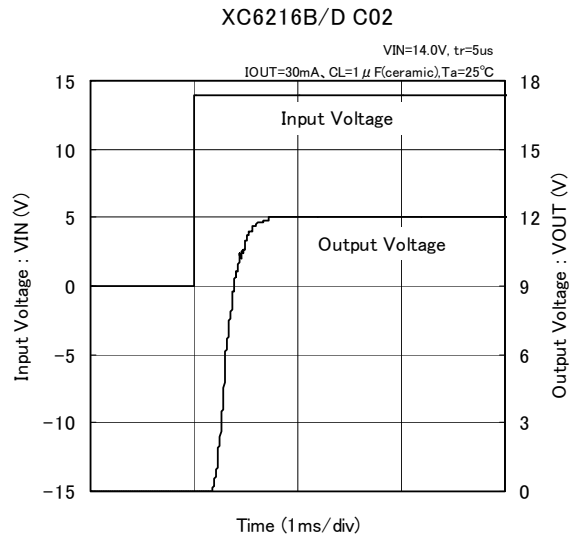
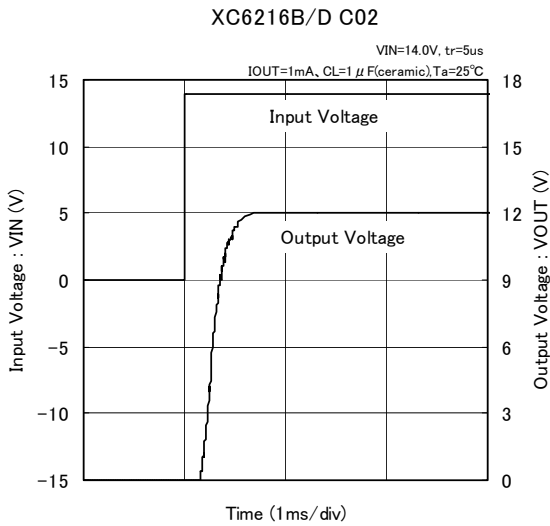
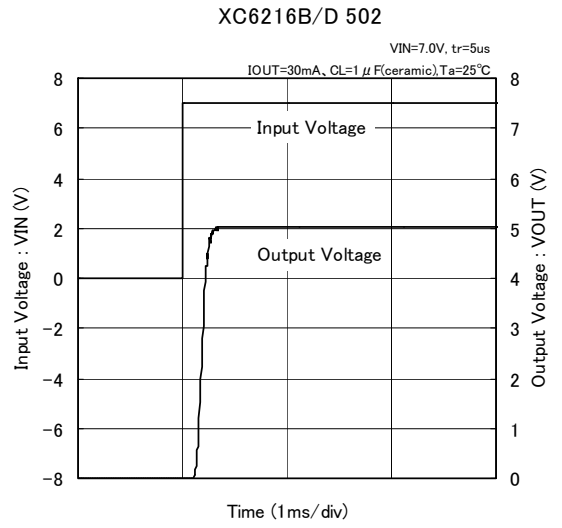
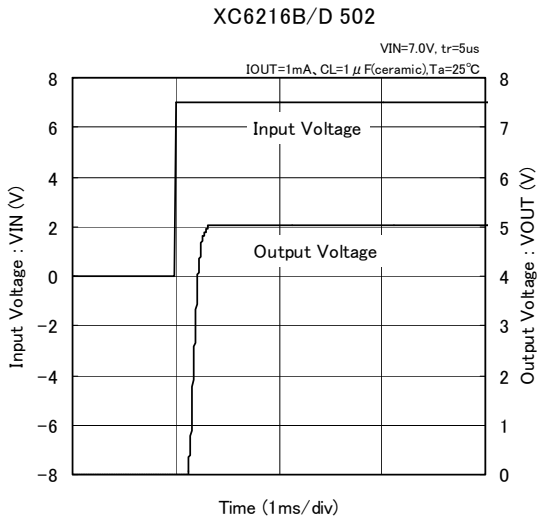

(9) CE Rise Time

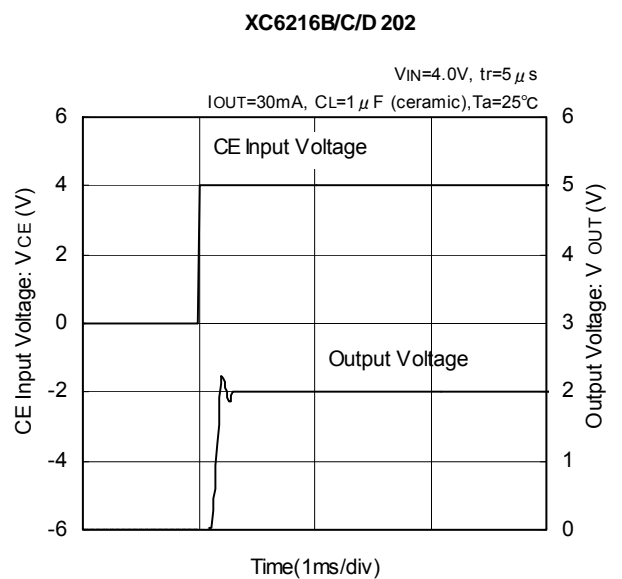
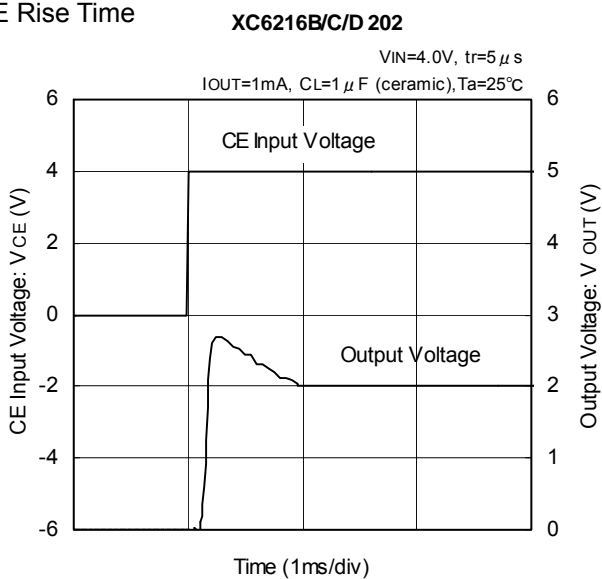

■ **TYPICAL PERFORMANCE CHARACTERISTICS (Continued)**

(9) CE Rise Time (Continued)

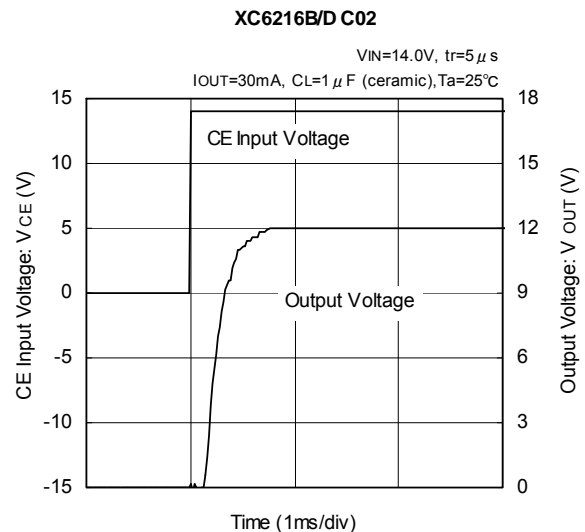
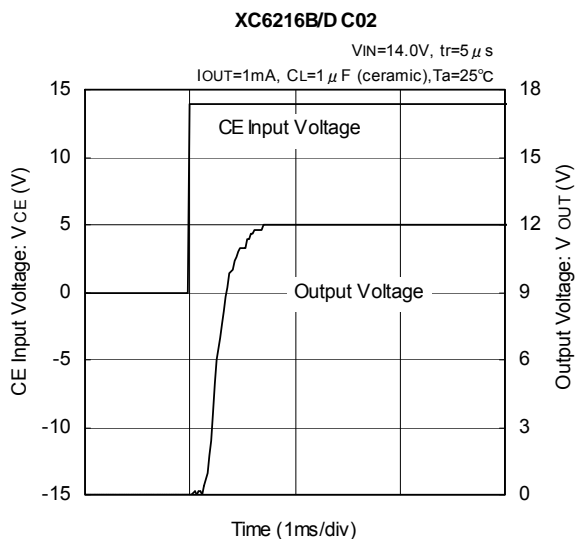
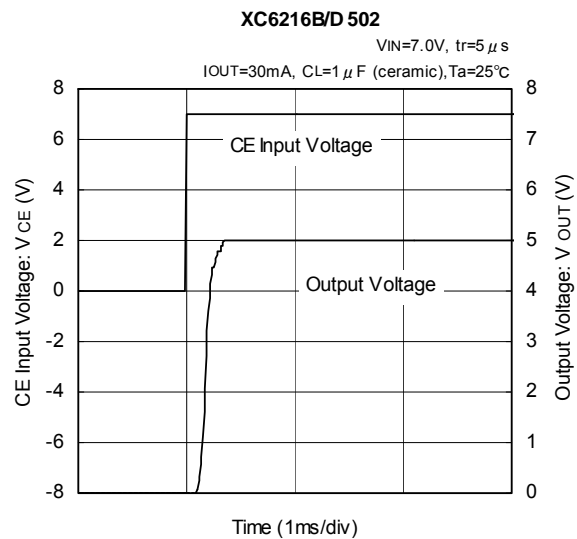
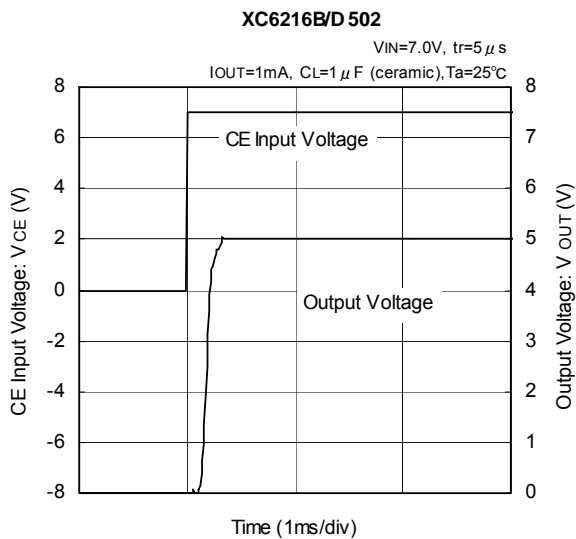
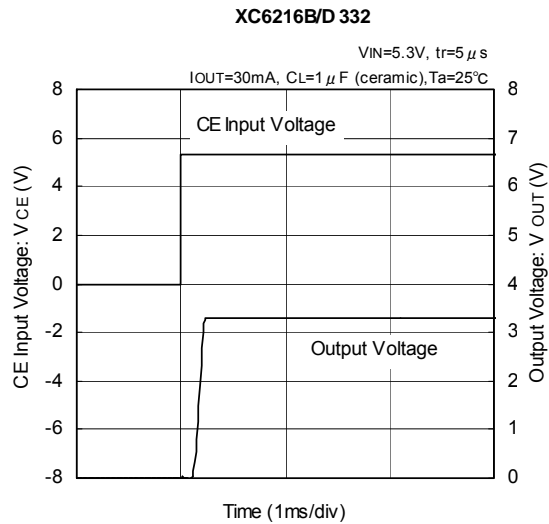
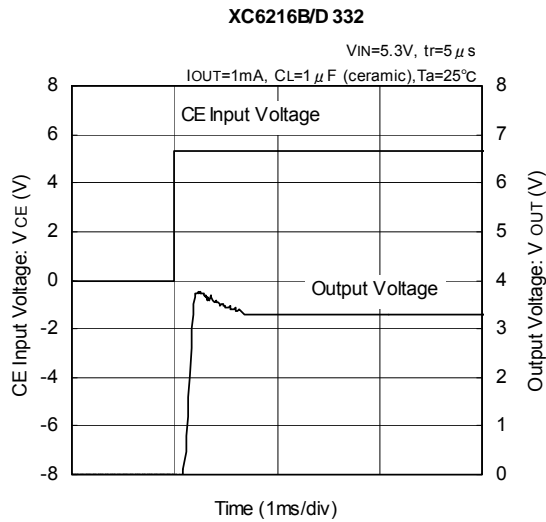

TYPICAL PERFORMANCE CHARACTERISTICS (Continued)

(10) Ripple Rejection Rate

XC6216B/C/D 202

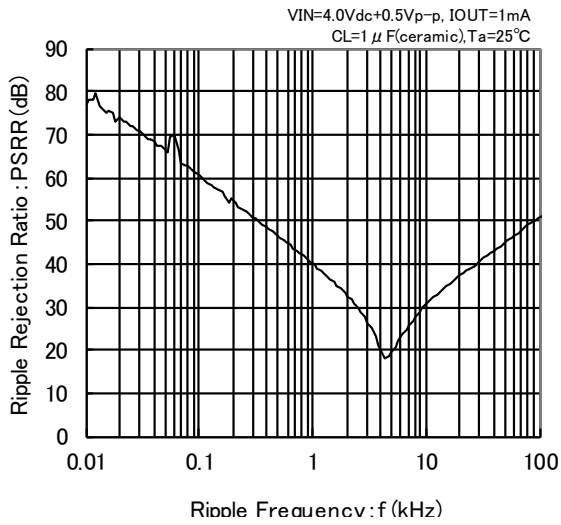

XC6216B/C/D 202

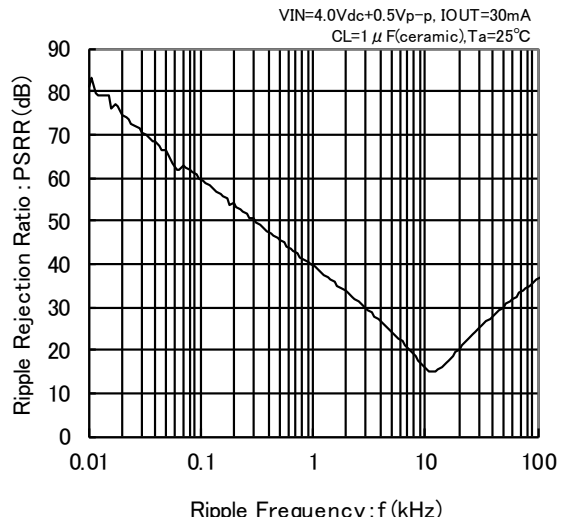

XC6216B/D 332

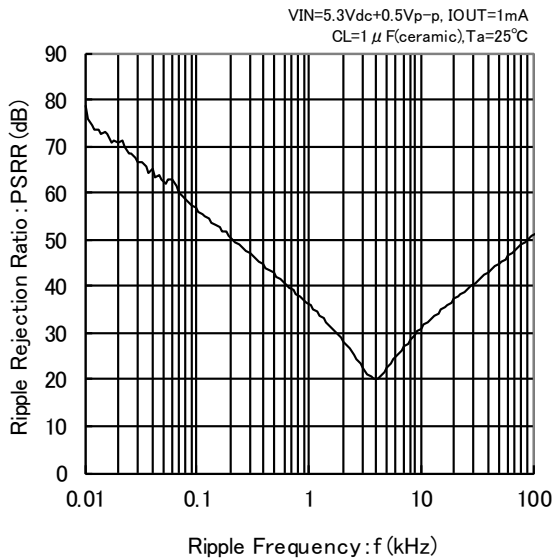

XC6216B/D 332

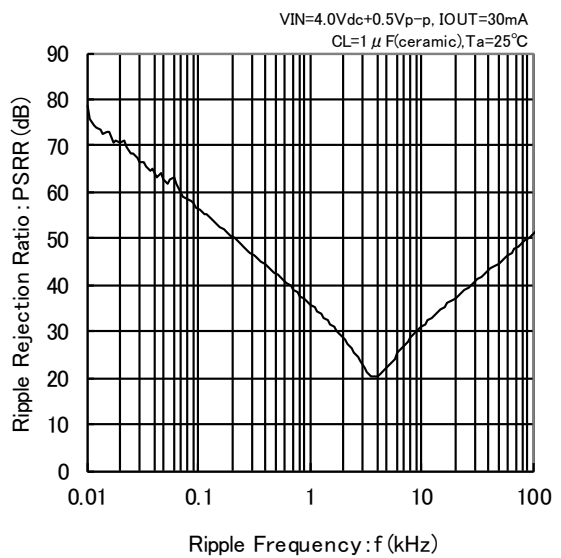

XC6216B/D 502

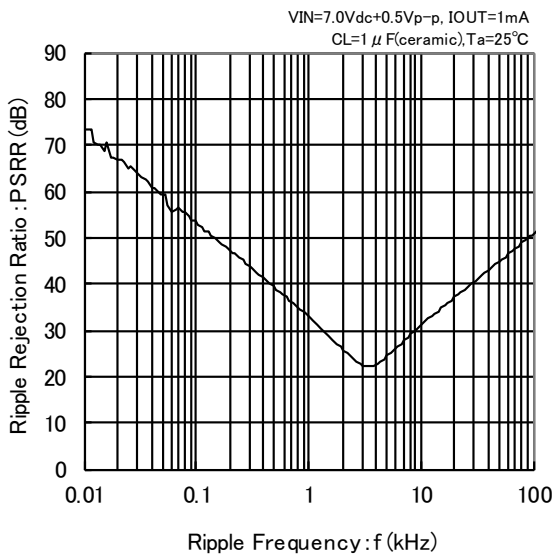

■ TYPICAL PERFORMANCE CHARACTERISTICS (Continued)

(10) Ripple Rejection Time (Continued)

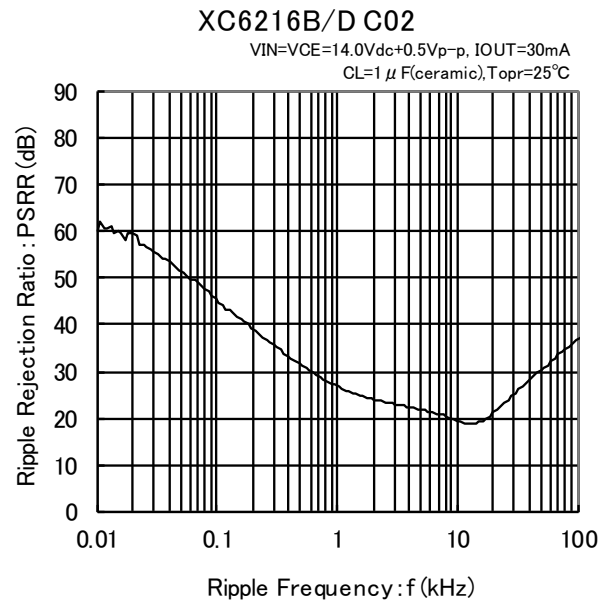
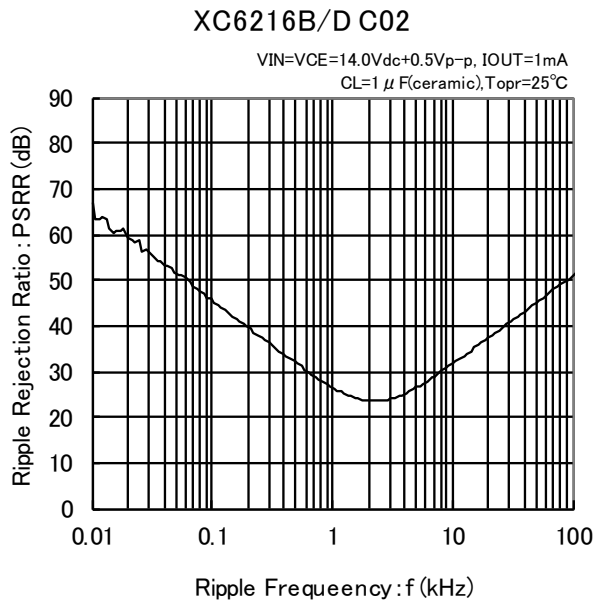

PACKAGING INFORMATION

● SOT-25

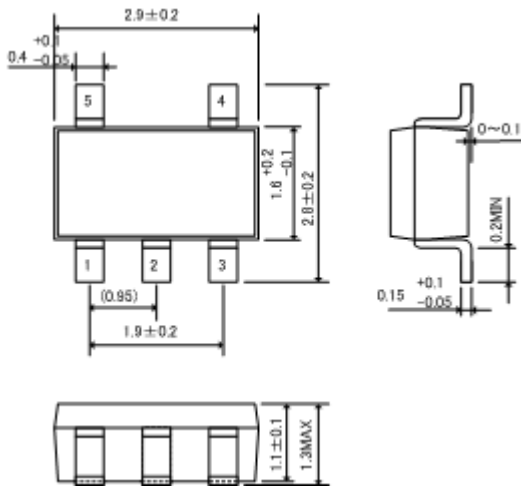

● SOT-25 Reference Pattern Layout

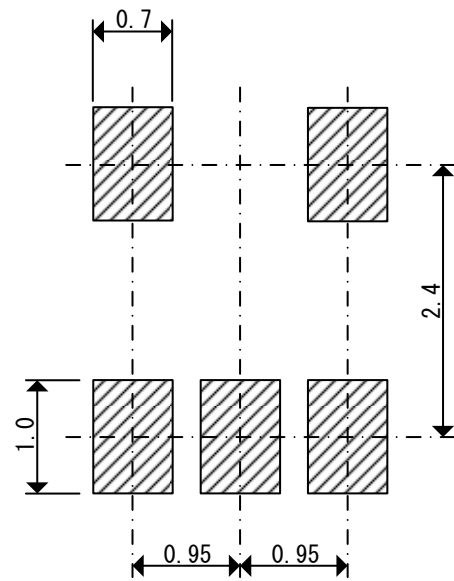

● SOT-23

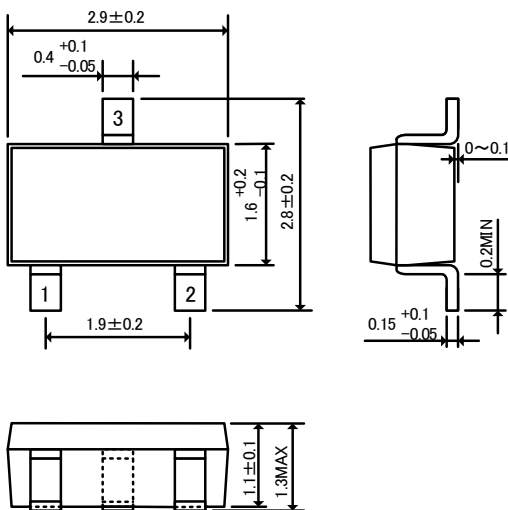

■ PACKAGING INFORMATION (Continued)

● SOT-89

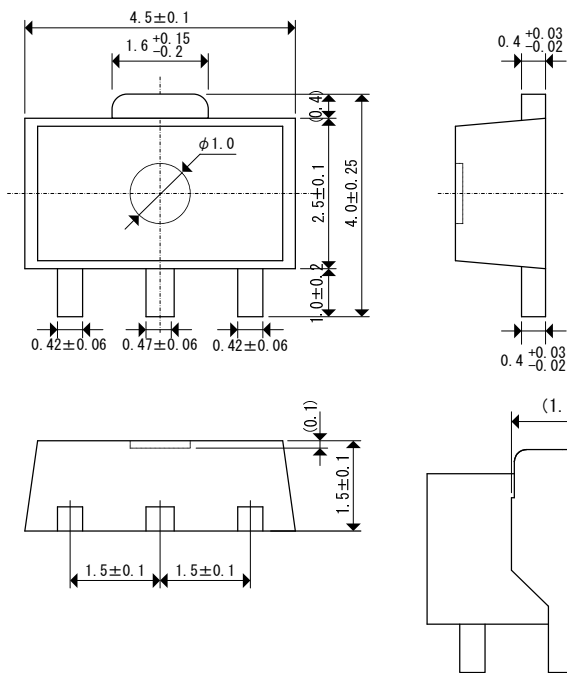

● SOT-89 Reference Pattern Layout

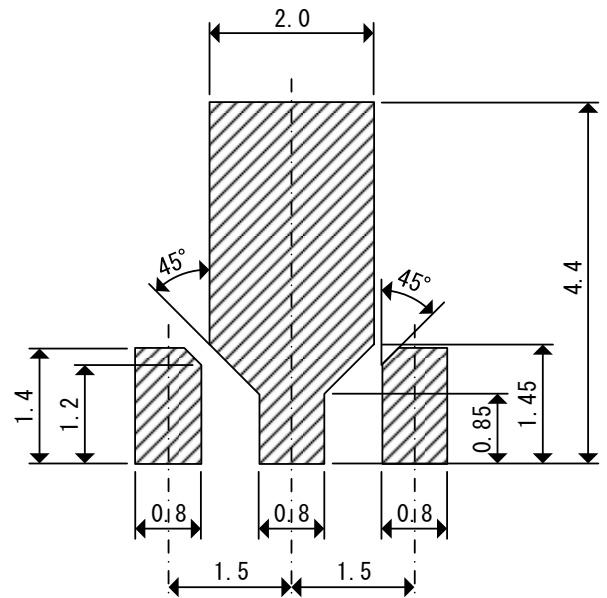

● SOT-89-5

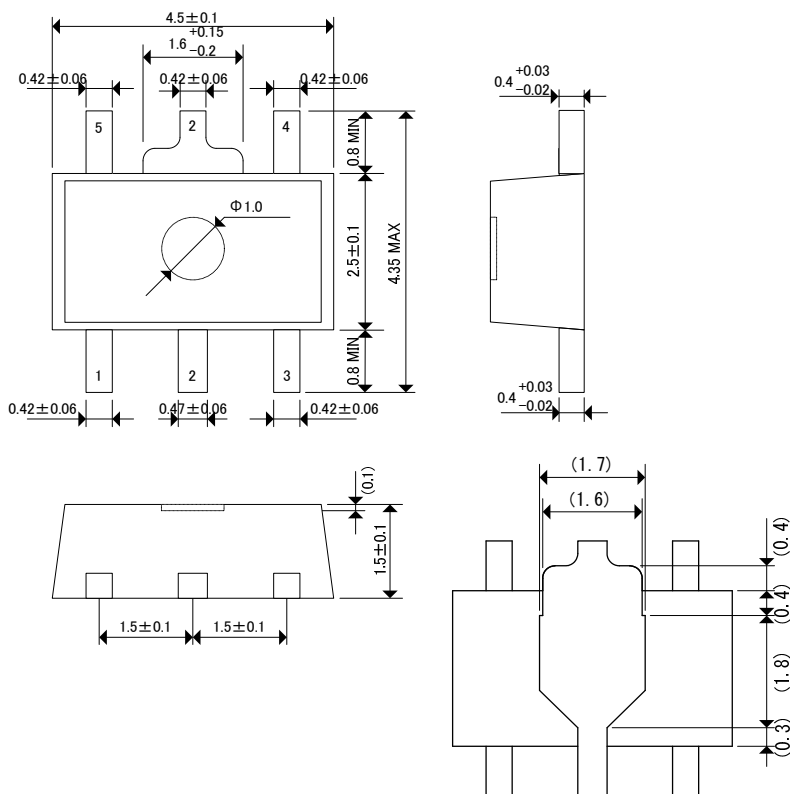

● SOT-89-5 Reference Pattern Layout

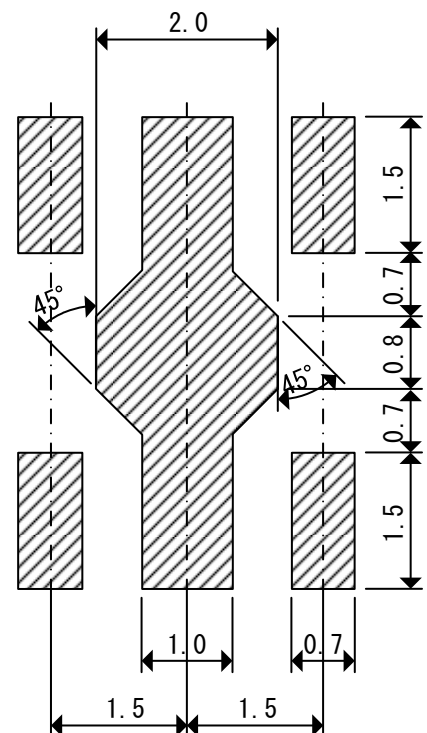

PACKAGING INFORMATION (Continued)

● SOT-223

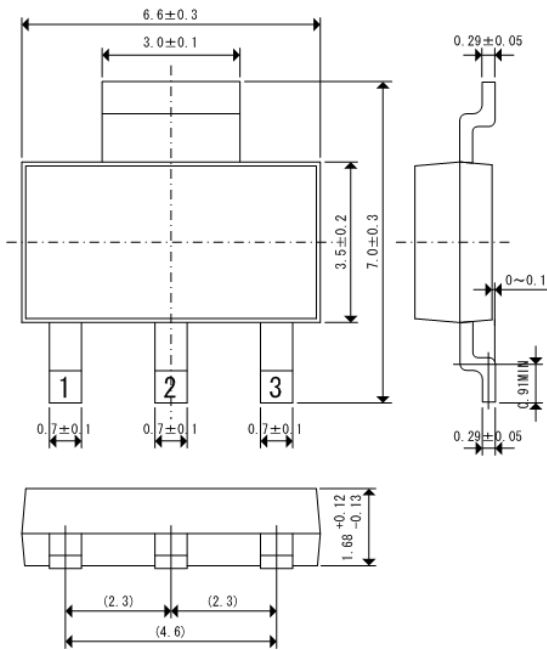

● TO-252

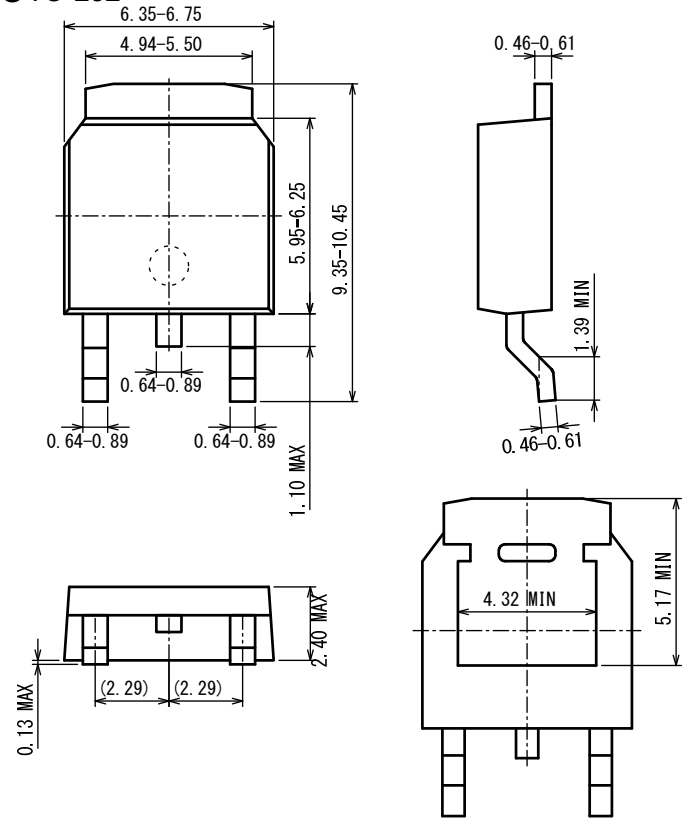

● USP-6C

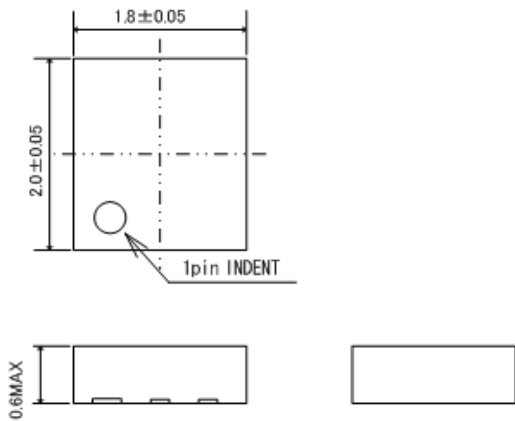

● USP-6C Reference Pattern Layout

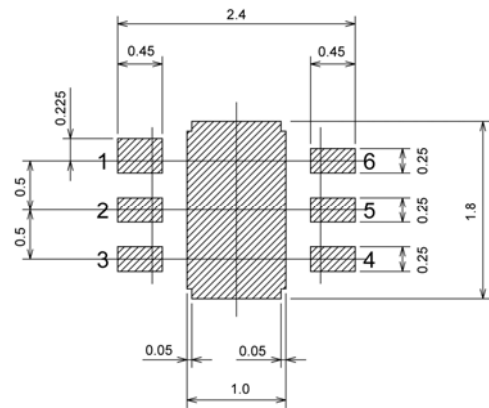

● USP-6C Reference Metal Mask Design

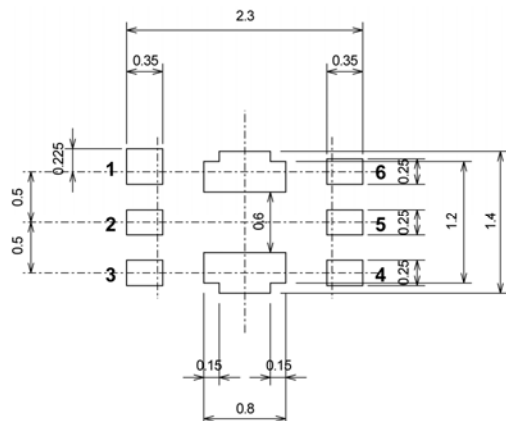
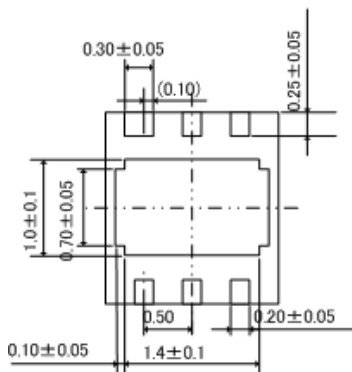

■ PACKAGING INFORMATION (Continued)

● USP-6B06

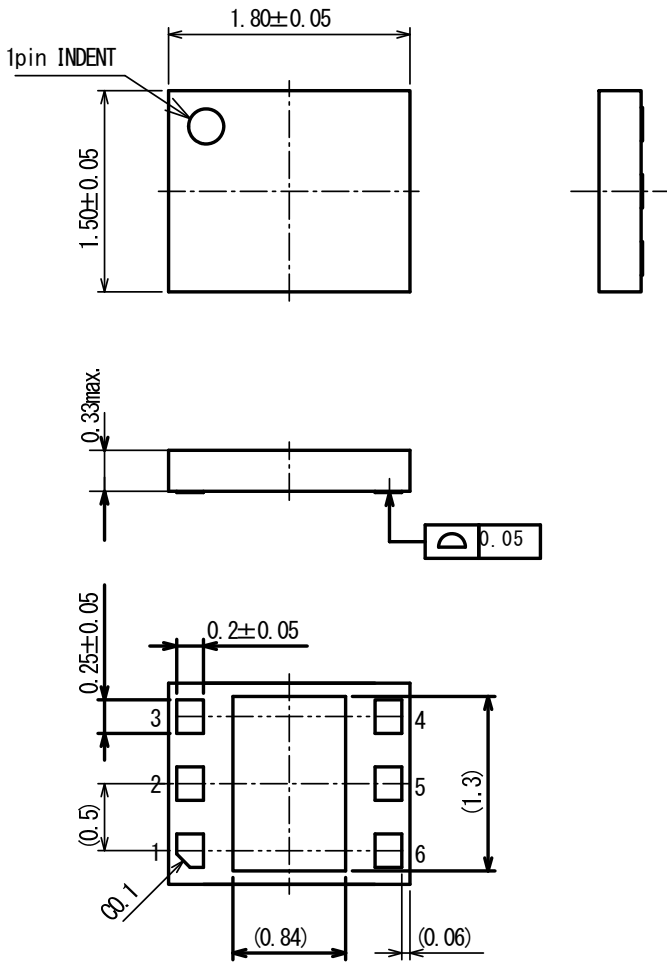

● USP-6B06 Reference Pattern Layout

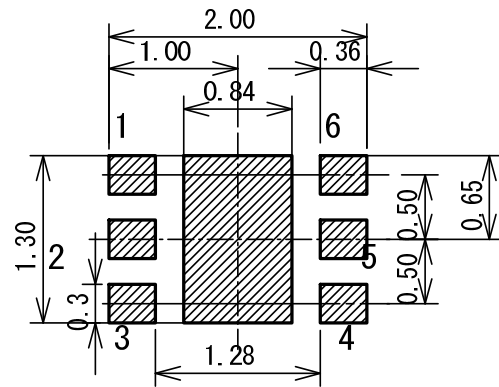

● USP-6B06 Reference Metal Mask Design

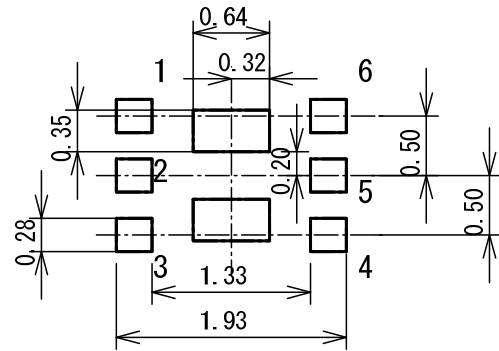

■ PACKAGING INFORMATION (Continued)

● SOT-25 Power Dissipation (40mm x 40mm Standard board)

Power dissipation data for the SOT-25 is shown in this page.

The value of power dissipation varies with the mount board conditions.

Please use this data as the reference data taken in the following condition.

1. Measurement Condition

Condition: Mount on a board

Ambient: Natural convection

Soldering: Lead (Pb) free

Board: Dimensions 40 x 40 mm

(1600 mm² in one side)

Copper (Cu) traces occupy 50% of the board

area in top and back faces

Package heat-sink is tied to the copper traces

(Board of SOT-26 is used.)

Material: Glass Epoxy (FR-4)

Thickness: 1.6mm

Through-hole: 4 x 0.8 Diameter

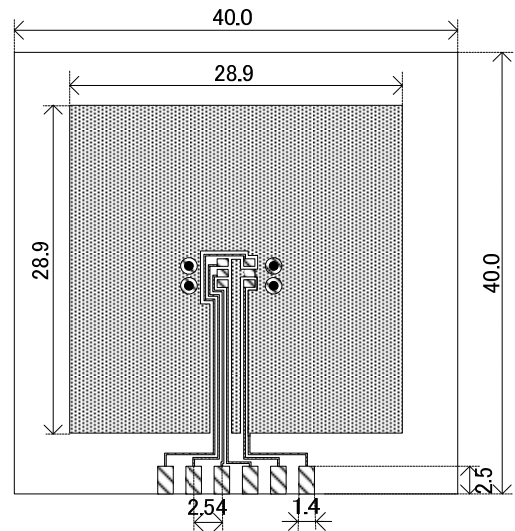

Evaluation Board (Unit: mm)

2. Power Dissipation vs. Ambient Temperature

Board Mount (T_j max = 125°C)

| Ambient Temperature (°C) | Power Dissipation Pd (mW) | Thermal Resistance (°C/W) |
|--------------------------|---------------------------|---------------------------|
| 25 | 600 | 166.67 |
| 85 | 240 | |

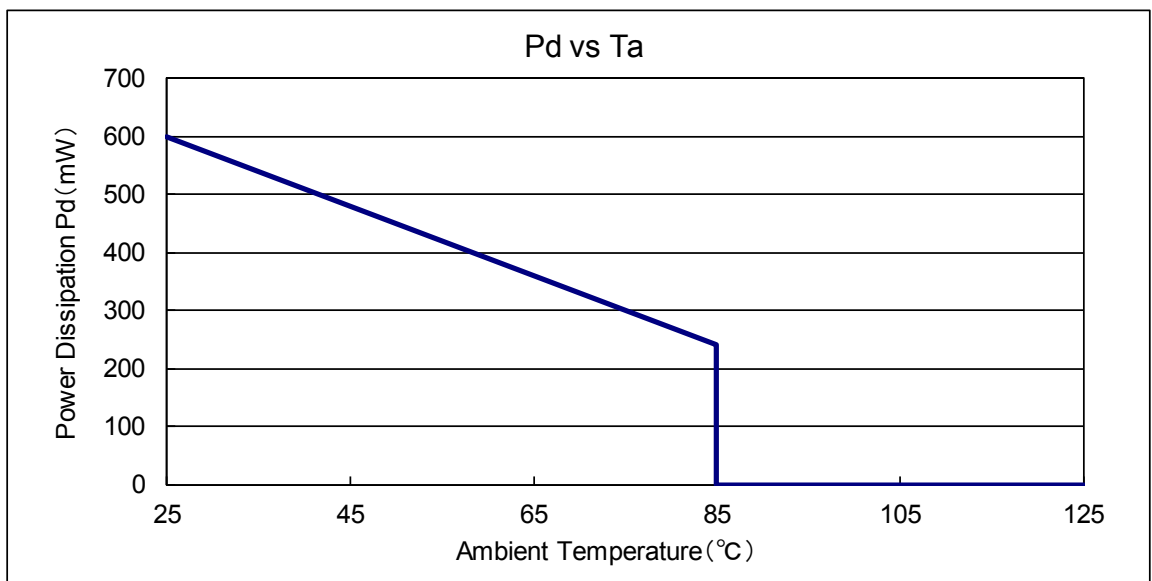

■ PACKAGING INFORMATION (Continued)

● SOT-89-5 Power Dissipation (40mm x 40mm Standard board)

Power dissipation data for the SOT-89-5 is shown in this page.
The value of power dissipation varies with the mount board conditions.
Please use this data as the reference data taken in the following condition.

1. Measurement Condition

- Condition: Mount on a board
- Ambient: Natural convection
- Soldering: Lead (Pb) free
- Board: Dimensions 40 x 40 mm
(1600 mm² in one side)
- Copper (Cu) traces occupy 50% of the board area in top and back faces
- Package heat-sink is tied to the copper traces
- Material: Glass Epoxy (FR-4)
- Thickness: 1.6mm
- Through-hole: 5 x 0.8 Diameter

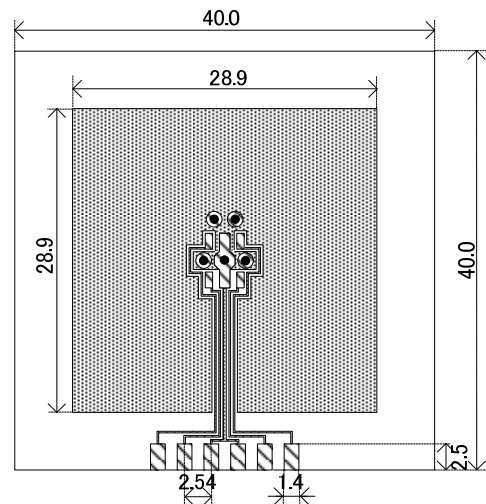

Evaluation Board (Unit: mm)

2. Power Dissipation vs. Ambient Temperature

Board Mount ($T_J \text{ max} = 125^\circ\text{C}$)

| Ambient Temperature ($^\circ\text{C}$) | Power Dissipation P_d (mW) | Thermal Resistance ($^\circ\text{C}/\text{W}$) |
|--|------------------------------|--|
| 25 | 1300 | 76.92 |
| 85 | 520 | |

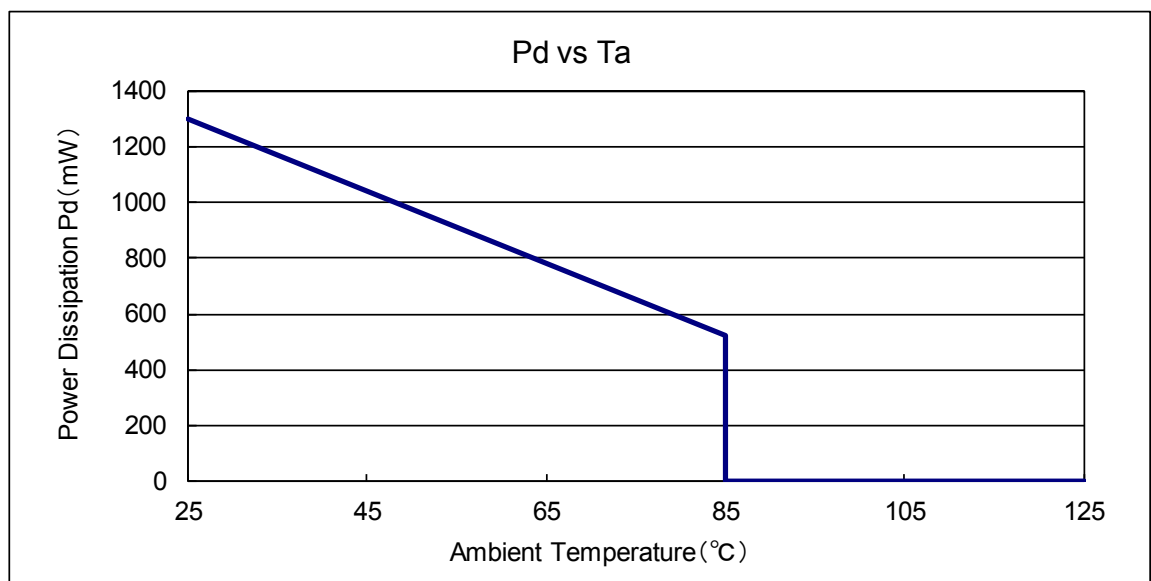

PACKAGING INFORMATION (Continued)

● USP-6C Power Dissipation (40mm x 40mm Standard board)

Power dissipation data for the USP-6C is shown in this page.

The value of power dissipation varies with the mount board conditions.

Please use this data as the reference data taken in the following condition.

1. Measurement Condition

Condition : Mount on a board

Ambient : Natural convection

Soldering : Lead (Pb) free

Board : Dimensions 40 x 40 mm
(1600 mm² in one side)

Copper (Cu) traces occupy 50% of the board
area in top and back faces

Package heat-sink is tied to the copper traces

Material : Glass Epoxy (FR-4)

Thickness : 1.6mm

Through-hole : 4 x 0.8 Diameter

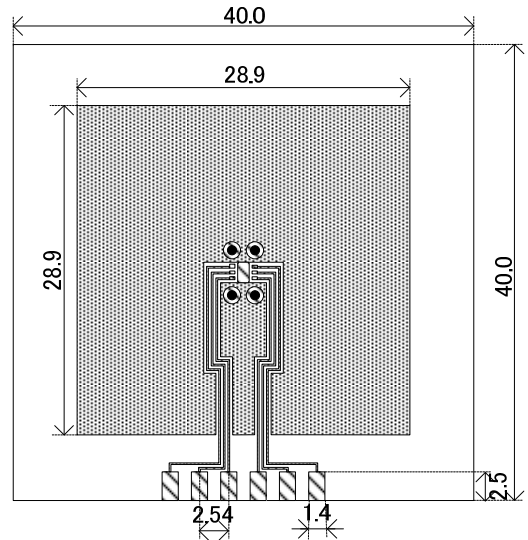

Evaluation Board (Unit: mm)

2. Power Dissipation vs. Ambient Temperature

Board Mount (T_j max = 125°C)

| Ambient Temperature (°C) | Power Dissipation Pd (mW) | Thermal Resistance (°C/W) |
|--------------------------|---------------------------|---------------------------|
| 25 | 1000 | 100.00 |
| 85 | 400 | |

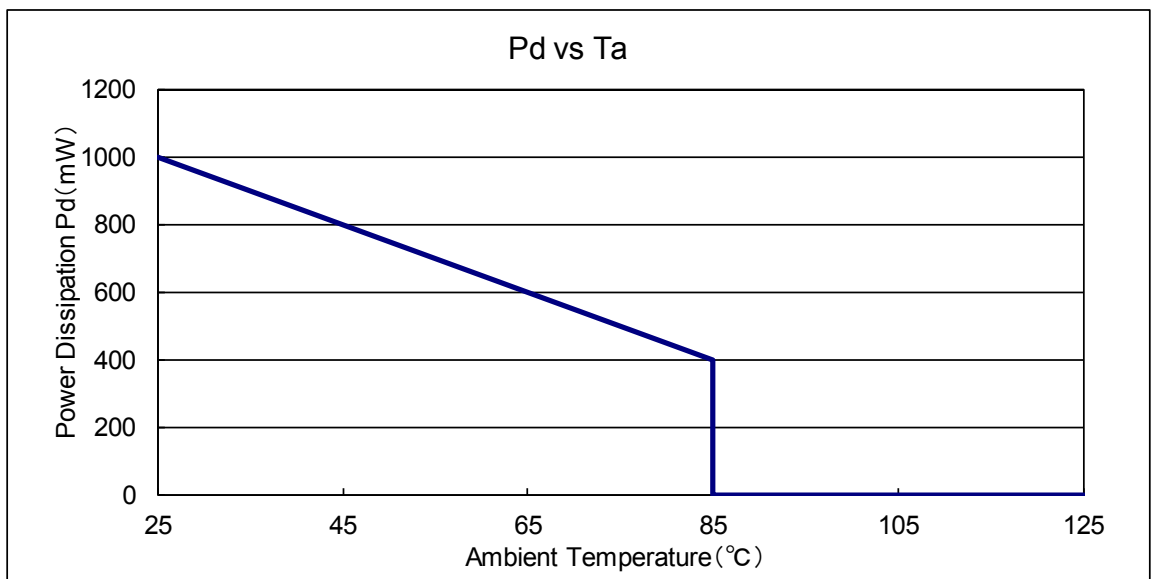

■ PACKAGING INFORMATION (Continued)

● SOT-223 Power Dissipation (40mm x 40mm Standard board)

Power dissipation data for the SOT-223 is shown in this page.

The value of power dissipation varies with the mount board conditions.

Please use this data as the reference data taken in the following condition.

1.1. Measurement Condition

Condition: Mount on a board

Ambient: Natural convection

Soldering: Lead (Pb) free

Board: Dimensions 40 x 40 mm
(1600 mm² in one side)

Copper (Cu) traces occupy 50% of the board
area in top and back faces

Package heat-sink is tied to the copper
traces

Material: Glass Epoxy (FR-4)

Thickness: 1.6mm

Through-hole: 4 x 0.8 Diameter

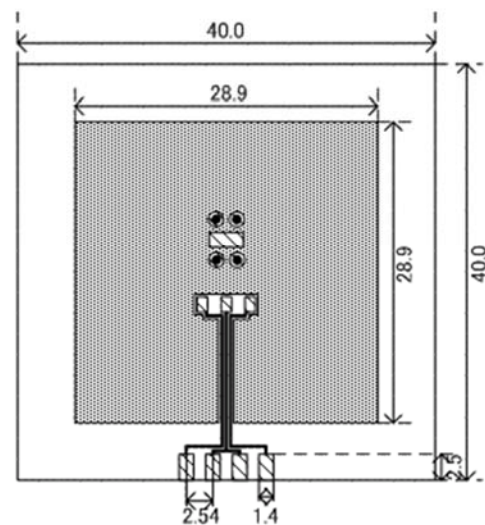

Evaluation Board (Unit: mm)

2. Power Dissipation vs. Ambient Temperature

Board Mount ($T_J \text{ max} = 125^\circ\text{C}$)

| Ambient Temperature ($^\circ\text{C}$) | Power Dissipation P_d (mW) | Thermal Resistance ($^\circ\text{C}/\text{W}$) |
|--|------------------------------|--|
| 25 | 1500 | 66.67 |
| 85 | 600 | |

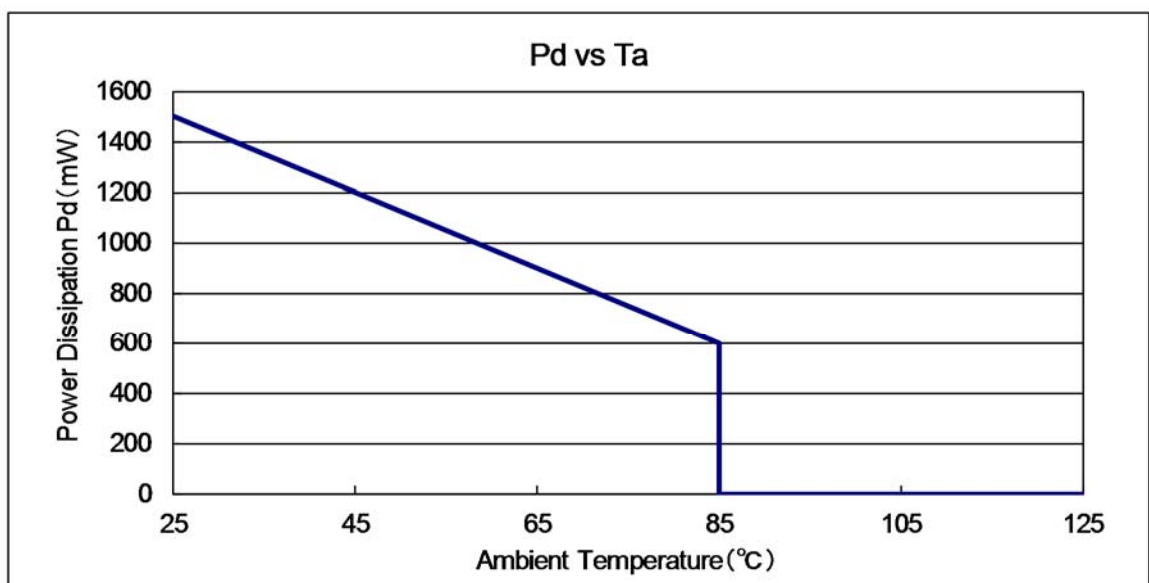

PACKAGING INFORMATION (Continued)

TO-252 Power Dissipation (40mm x 40mm Standard board)

Power dissipation data for the TO-252 is shown in this page.
The value of power dissipation varies with the mount board conditions.
Please use this data as the reference data taken in the following condition.

1. Measurement Condition

- Condition : Mount on a board
- Ambient : Natural convection
- Soldering : Lead (Pb) free
- Board : Dimensions 40 x 40 mm
(1600 mm² in one side)
Copper (Cu) traces occupy 50% of the board area in top and back faces
Package heat-sink is tied to the copper traces
- Material : Glass Epoxy (FR-4)
- Thickness : 1.6mm
- Through-hole : 4 x 0.8 Diameter

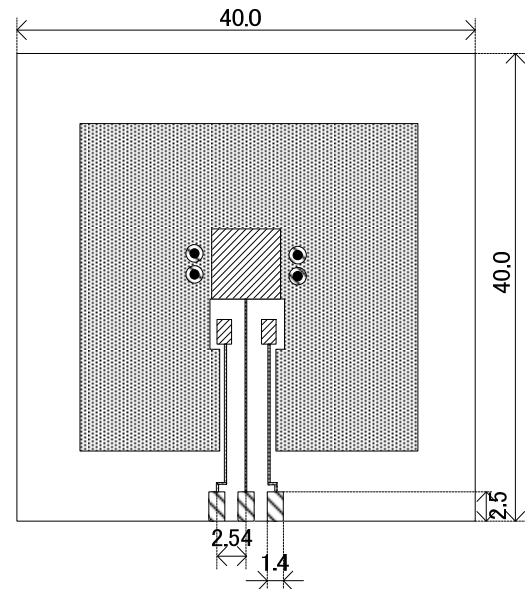

Evaluation Board (Unit: mm)

2. Power Dissipation vs. Ambient Temperature

Board Mount ($T_j \text{ max} = 125^\circ\text{C}$)

| Ambient Temperature ($^\circ\text{C}$) | Power Dissipation P_d (mW) | Thermal Resistance ($^\circ\text{C}/\text{W}$) |
|--|------------------------------|--|
| 25 | 1800 | 55.56 |
| 85 | 720 | |

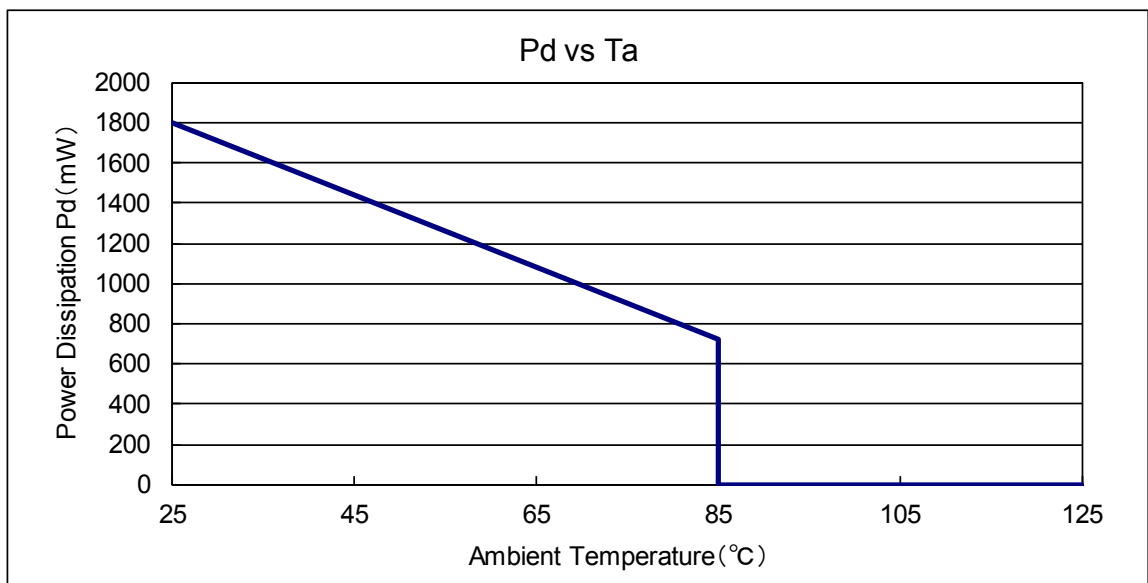

■ PACKAGING INFORMATION (Continued)

● SOT-89 Power Dissipation (40mm x 40mm Standard board)

Power dissipation data for the SOT-89 is shown in this page.

The value of power dissipation varies with the mount board conditions.

Please use this data as the reference data taken in the following condition.

1. Measurement Condition

Condition: Mount on a board

Ambient: Natural convection

Soldering: Lead (Pb) free

Board: Dimensions 40 x 40 mm
(1600 mm² in one side)

Copper (Cu) traces occupy 50% of the board
area in top and back faces

Package heat-sink is tied to the copper traces

Material: Glass Epoxy (FR-4)

Thickness: 1.6mm

Through-hole: 5 x 0.8 Diameter

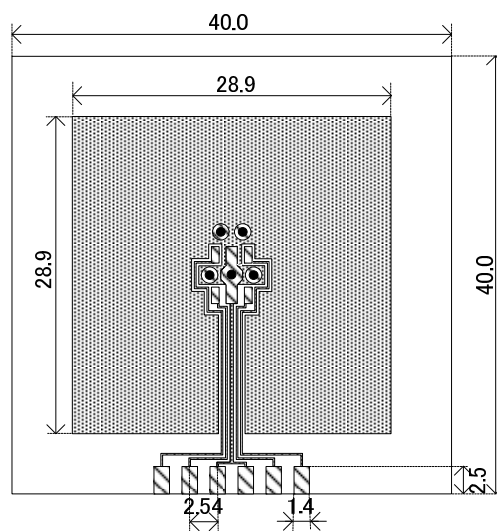

Evaluation Board (Unit: mm)

2. Power Dissipation vs. Ambient Temperature

Board Mount ($T_j \text{ max} = 125^\circ\text{C}$)

| Ambient Temperature ($^\circ\text{C}$) | Power Dissipation Pd (mW) | Thermal Resistance ($^\circ\text{C}/\text{W}$) |
|--|---------------------------|--|
| 25 | 1000 | 100.00 |
| 85 | 400 | |

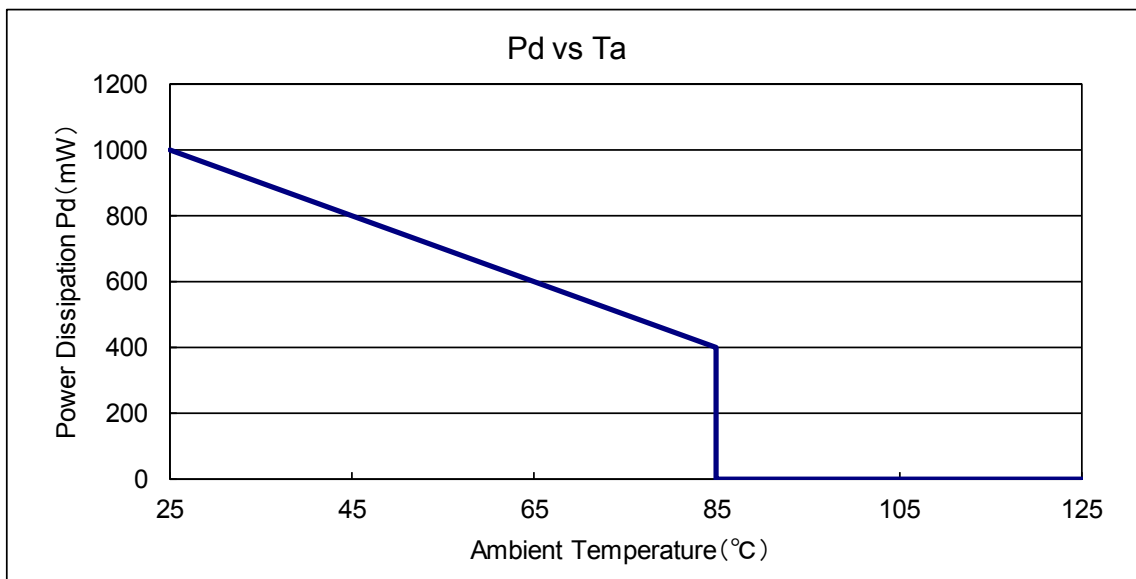

■ PACKAGING INFORMATION (Continued)

● USP-6B06 Power Dissipation (40mm x 40mm Standard board)

Power dissipation data for the USP-6B06 is shown in this page.

The value of power dissipation varies with the mount board conditions.

Please use this data as the reference data taken in the following condition.

1. Measurement Condition

Condition: Mount on a board

Ambient: Natural convection

Soldering: Lead (Pb) free

Board: Dimensions 40 x 40 mm

(1600 mm² in one side)

Copper (Cu) traces occupy 50% of the board

area in top and back faces

Package heat-sink is tied to the copper traces

Material: Glass Epoxy (FR-4)

Thickness: 1.6mm

Through-hole: 4 x 0.8 Diameter

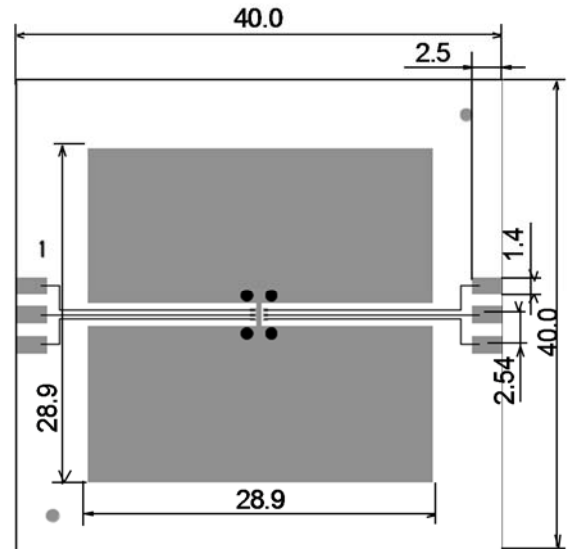

Evaluation Board (Unit: mm)

2. Power Dissipation vs. Ambient Temperature

Board Mount (T_j max = 125°C)

| Ambient Temperature (°C) | Power Dissipation Pd (mW) | Thermal Resistance (°C/W) |
|--------------------------|---------------------------|---------------------------|
| 25 | 900 | 111.11 |
| 85 | 360 | |

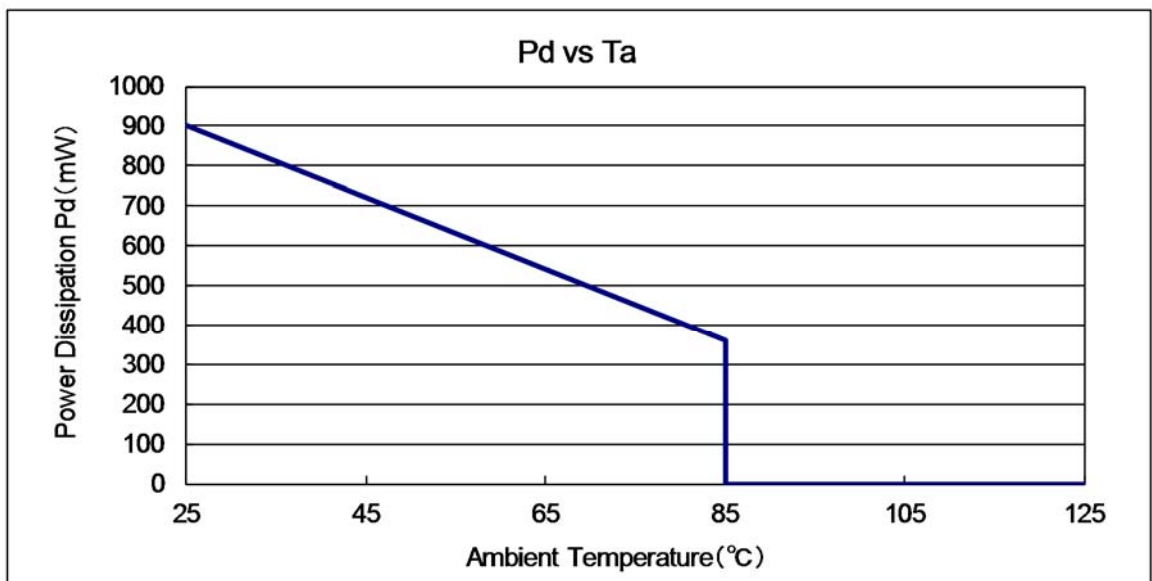

■ PACKAGING INFORMATION (Continued)

● USP-6C Power Dissipation (JEDEC board)

Power dissipation data for the USP-6C is shown in this page.

The value of power dissipation varies with the mount board conditions.

Please use this data as one of reference data taken in the described condition.

1. Measurement Condition (Reference data)

Condition : Mount on a board

Ambient : Natural convection

Soldering : Lead (Pb) free

Board : The board using 4 copper layer.

(76.2mm×114.3mm···Area: about 8700mm²)

1st layer : No copper foil (Signal layer)

2nd layer : 70mm×70mm_Connected to heat-sink.

3rd layer : 70mm×70mm_Connected to heat-sink.

4th layer : No copper foil (Signal layer)

Material : Glass Epoxy (FR-4)

Thickness : 1.6mm

Through-hole : φ0.2mm x 60pcs

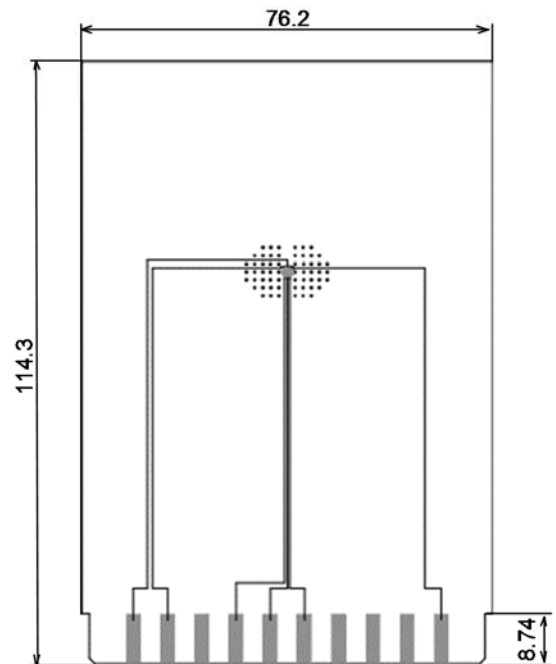

Evaluation Board (Unit: mm)

2. Power Dissipation vs. Ambient Temperature

Board Mount (T_j max = 125°C)

| Ambient Temperature (°C) | Power Dissipation Pd (mW) | Thermal Resistance (°C/W) |
|--------------------------|---------------------------|---------------------------|
| 25 | 1250 | 80.00 |
| 85 | 500 | |

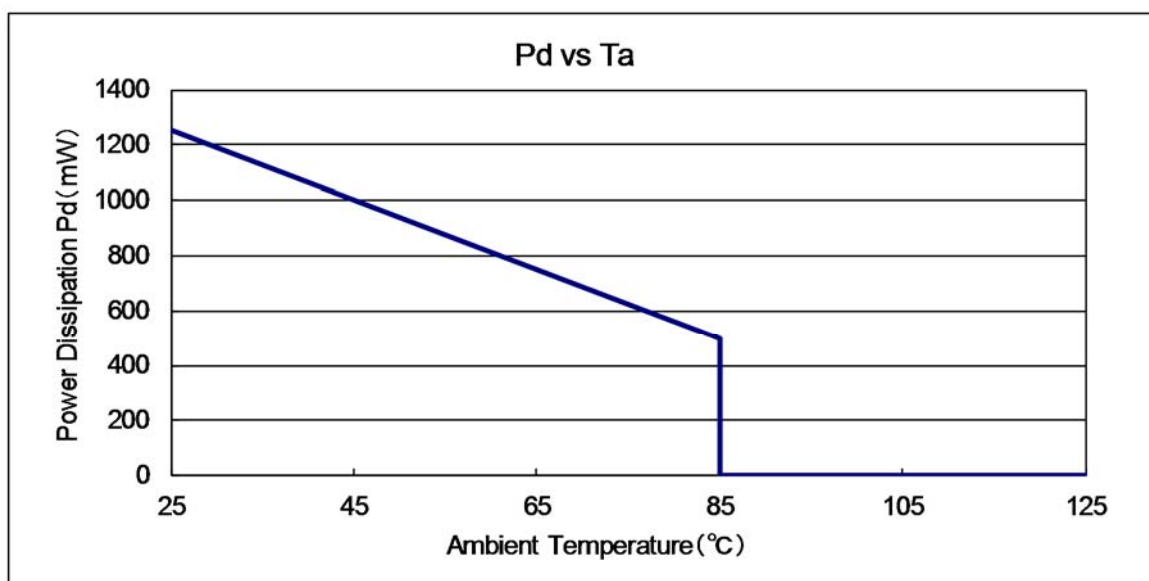

MARKING RULE (XC6216 Series)

● SOT-25, SOT-89, SOT-89-5, USP-6C, SOT-223, TO-252, USP-6B06, SOT-23

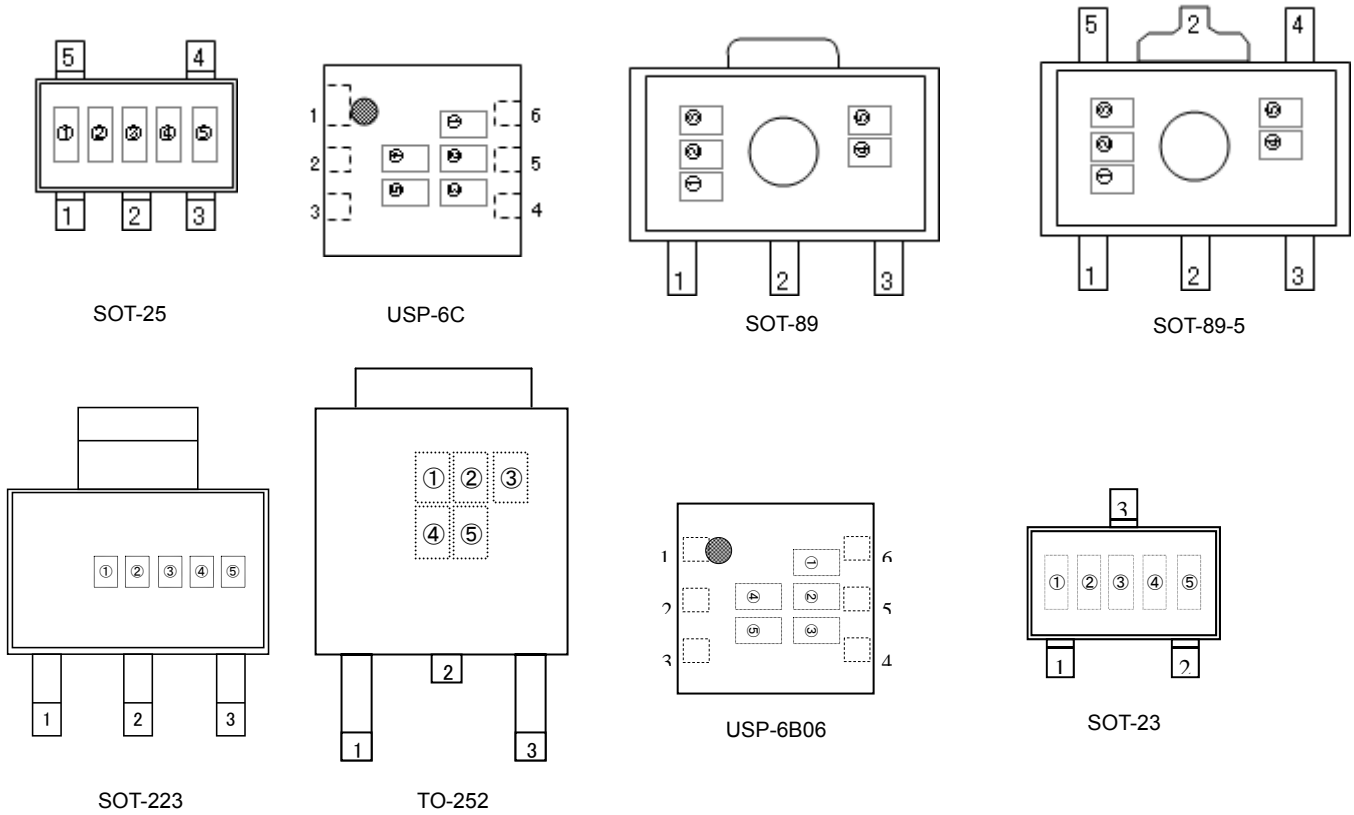

(mark header : ①~③) *Mark header does not change with a lot.

① represents the product series

| MARK | PRODUCT SERIES |
|------|----------------|
| 2 | XC6216xxxxxx |

② represents the output voltage range

| MARK | VOLTAGE (V) | PRODUCT SERIES |
|------|-------------|----------------|
| 0 | 1.8~3.0 | XC6216Bxxxxx |
| 1 | 3.1~6.0 | |
| 2 | 6.1~9.0 | |
| 3 | 9.1~12.0 | |
| 4 | 1.8~3.0 | XC6216Dxxxxx |
| 5 | 3.1~6.0 | |
| 6 | 6.1~9.0 | |
| 7 | 9.1~12.0 | |
| 8 | 2.0 | XC6216Cxxxxx |

■ **MARKING RULE (XC6216 Series) (Continued)**

③ represents the output voltage

| MARK | VOLTAGE(V) | | | | MARK | VOLTAGE(V) | | | |
|------|------------|-----|-----|------|------|------------|-----|-----|------|
| 0 | - | 3.1 | 6.1 | 9.1 | F | - | 4.6 | 7.6 | 10.6 |
| 1 | - | 3.2 | 6.2 | 9.2 | H | - | 4.7 | 7.7 | 10.7 |
| 2 | - | 3.3 | 6.3 | 9.3 | K | 1.8 | 4.8 | 7.8 | 10.8 |
| 3 | - | 3.4 | 6.4 | 9.4 | L | 1.9 | 4.9 | 7.9 | 10.9 |
| 4 | - | 3.5 | 6.5 | 9.5 | M | 2.0 | 5.0 | 8.0 | 11.0 |
| 5 | - | 3.6 | 6.6 | 9.6 | N | 2.1 | 5.1 | 8.1 | 11.1 |
| 6 | - | 3.7 | 6.7 | 9.7 | P | 2.2 | 5.2 | 8.2 | 11.2 |
| 7 | - | 3.8 | 6.8 | 9.8 | R | 2.3 | 5.3 | 8.3 | 11.3 |
| 8 | - | 3.9 | 6.9 | 9.9 | S | 2.4 | 5.4 | 8.4 | 11.4 |
| 9 | - | 4.0 | 7.0 | 10.0 | T | 2.5 | 5.5 | 8.5 | 11.5 |
| A | - | 4.1 | 7.1 | 10.1 | U | 2.6 | 5.6 | 8.6 | 11.6 |
| B | - | 4.2 | 7.2 | 10.2 | V | 2.7 | 5.7 | 8.7 | 11.7 |
| C | - | 4.3 | 7.3 | 10.3 | X | 2.8 | 5.8 | 8.8 | 11.8 |
| D | - | 4.4 | 7.4 | 10.4 | Y | 2.9 | 5.9 | 8.9 | 11.9 |
| E | - | 4.5 | 7.5 | 10.5 | Z | 3.0 | 6.0 | 9.0 | 12.0 |

④⑤ represents assembly lot number

01 to 09, 0A to 0Z, 11 to 9Z, A1 to A9, AA to AZ, B1 to ZZ repeated (G, I, J, O, Q, W excluded)

Note: No character inversion used.

MARKING RULE (XE6216 Series)

● SOT-89-5

① represents the product series

| MARK | PRODUCT SERIES |
|------|----------------|
| 2 | XE6216xxxxxx |

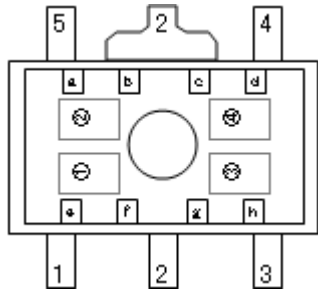

SOT-89-5

② represents the output voltage range

| MARK | VOLTAGE (V) | PRODUCT SERIES |
|------|-------------|----------------|
| 0 | 2.0~3.0 | XE6216Bxxxxx |
| 1 | 3.1~6.0 | |
| 2 | 6.1~9.0 | |
| 3 | 9.1~12.0 | |

| MARK | VOLTAGE(V) | | | MARK | VOLTAGE(V) | | | | |
|------|------------|-----|-----|------|------------|-----|-----|-----|------|
| 0 | - | 3.1 | 6.1 | 9.1 | F | - | 4.6 | 7.6 | 10.6 |
| 1 | - | 3.2 | 6.2 | 9.2 | H | - | 4.7 | 7.7 | 10.7 |
| 2 | - | 3.3 | 6.3 | 9.3 | K | - | 4.8 | 7.8 | 10.8 |
| 3 | - | 3.4 | 6.4 | 9.4 | L | - | 4.9 | 7.9 | 10.9 |
| 4 | - | 3.5 | 6.5 | 9.5 | M | 2.0 | 5.0 | 8.0 | 11.0 |
| 5 | - | 3.6 | 6.6 | 9.6 | N | 2.1 | 5.1 | 8.1 | 11.1 |
| 6 | - | 3.7 | 6.7 | 9.7 | P | 2.2 | 5.2 | 8.2 | 11.2 |
| 7 | - | 3.8 | 6.8 | 9.8 | R | 2.3 | 5.3 | 8.3 | 11.3 |
| 8 | - | 3.9 | 6.9 | 9.9 | S | 2.4 | 5.4 | 8.4 | 11.4 |
| 9 | - | 4.0 | 7.0 | 10.0 | T | 2.5 | 5.5 | 8.5 | 11.5 |
| A | - | 4.1 | 7.1 | 10.1 | U | 2.6 | 5.6 | 8.6 | 11.6 |
| B | - | 4.2 | 7.2 | 10.2 | V | 2.7 | 5.7 | 8.7 | 11.7 |
| C | - | 4.3 | 7.3 | 10.3 | X | 2.8 | 5.8 | 8.8 | 11.8 |
| D | - | 4.4 | 7.4 | 10.4 | Y | 2.9 | 5.9 | 8.9 | 11.9 |
| E | - | 4.5 | 7.5 | 10.5 | Z | 3.0 | 6.0 | 9.0 | 12.0 |

④ represents assembly lot number

0, ..., 9, A, B, ..., Z, □, ..., □, A, B, ..., □, 0, ... repeated (G, I, J, O, Q, W excluded)

Bar marking of a-b-c-d combination represents production year.

Bar marking of e-f-g-h combination represents production month.

| Production Year | a | b | c | d |
|-----------------|---|---|---|---|
| xxx0 | □ | - | - | - |
| xxx1 | - | □ | - | - |
| xxx2 | - | - | □ | - |
| xxx3 | - | - | - | □ |
| xxx4 | □ | □ | - | - |
| xxx5 | □ | - | □ | - |
| xxx6 | □ | - | - | □ |
| xxx7 | - | □ | □ | - |
| xxx8 | - | □ | - | □ |
| xxx9 | - | - | □ | □ |

| Production Month | e | f | g | h |
|------------------|---|---|---|---|
| January | □ | - | - | - |
| February | - | □ | - | - |
| March | - | - | □ | - |
| April | - | - | - | □ |
| May | □ | □ | - | - |
| June | □ | - | □ | - |
| July | □ | - | - | □ |
| August | - | □ | □ | - |
| September | - | □ | - | □ |
| October | - | - | □ | □ |
| November | □ | □ | □ | - |
| December | □ | □ | - | □ |

1. The product and product specifications contained herein are subject to change without notice to improve performance characteristics. Consult us, or our representatives before use, to confirm that the information in this datasheet is up to date.
2. The information in this datasheet is intended to illustrate the operation and characteristics of our products. We neither make warranties or representations with respect to the accuracy or completeness of the information contained in this datasheet nor grant any license to any intellectual property rights of ours or any third party concerning with the information in this datasheet.
3. Applicable export control laws and regulations should be complied and the procedures required by such laws and regulations should also be followed, when the product or any information contained in this datasheet is exported.
4. The product is neither intended nor warranted for use in equipment of systems which require extremely high levels of quality and/or reliability and/or a malfunction or failure which may cause loss of human life, bodily injury, serious property damage including but not limited to devices or equipment used in 1) nuclear facilities, 2) aerospace industry, 3) medical facilities, 4) automobile industry and other transportation industry and 5) safety devices and safety equipment to control combustions and explosions. Do not use the product for the above use unless agreed by us in writing in advance.
5. Although we make continuous efforts to improve the quality and reliability of our products; nevertheless Semiconductors are likely to fail with a certain probability. So in order to prevent personal injury and/or property damage resulting from such failure, customers are required to incorporate adequate safety measures in their designs, such as system fail safes, redundancy and fire prevention features.
6. Our products are not designed to be Radiation-resistant.
7. Please use the product listed in this datasheet within the specified ranges.
8. We assume no responsibility for damage or loss due to abnormal use.
9. All rights reserved. No part of this datasheet may be copied or reproduced unless agreed by Torex Semiconductor Ltd in writing in advance.

TOREX SEMICONDUCTOR LTD.

单击下面可查看定价，库存，交付和生命周期等信息

[>>Torex Semiconductor\(特瑞仕\)](#)