

Aximax, 400, Conformally Coated, X7R Dielectric, 25 – 250 VDC (Commercial Grade)

Overview

KEMET's Aximax conformally coated axial leaded ceramic capacitors in X7R dielectric feature a 125°C maximum operating temperature. The Electronics Industries Alliance (EIA) characterizes X7R dielectric as a Class II "temperature stable" material. Components of this classification are fixed, ceramic dielectric capacitors suited for bypass and decoupling applications or for frequency discriminating circuits where Q and stability of capacitance characteristics are not critical. X7R

exhibits a predictable change in capacitance with respect to time and voltage and boasts a minimal change in capacitance with reference to ambient temperature. Capacitance change is limited to $\pm 15\%$ from -55°C to $+125^\circ\text{C}$.

These devices meets the flame test requirements outlined in UL Standard 94V-0.

Benefits

- Axial leaded form factor
- Conformally coated
- Encapsulation meets flammability standard UL 94V-0
- Operating temperature range of -55°C to $+125^\circ\text{C}$
- Lead (Pb)-free, RoHS and REACH compliant
- X7R Temperature stable dielectric
- DC voltage ratings of 25 V, 50 V, 100 V, 200 V, and 250 V
- Capacitance offerings ranging from 10 pF to 10 μF
- Available capacitance tolerances of $\pm 5\%$, $\pm 10\%$ and $\pm 20\%$
- Non-polar device, minimizing installation concerns
- 100% pure matte tin-plated lead finish allowing for excellent solderability
- SnPb-plated lead finish option available upon request (Sn60/Pb40)

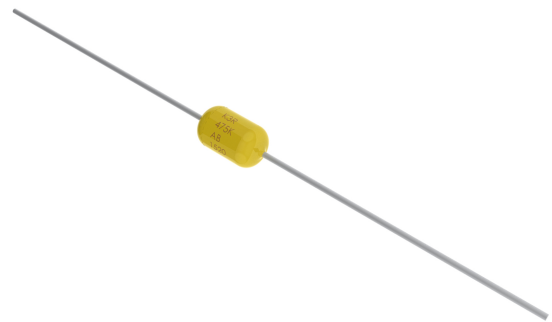

Ordering Information

C	410	C	105	K	3	R	5	T	A	7200
Ceramic	Style/Size	Specification/ Series	Capacitance Code (pF)	Capacitance Tolerance ¹	Rated Voltage (VDC)	Dielectric	Design	Lead Finish ²	Failure Rate	Packaging (C-Spec)
	410 412 420 430 440	C = Standard	First two digits represent significant figures. Third digit specifies number of zeros.	J = $\pm 5\%$ K = $\pm 10\%$ M = $\pm 20\%$	3 = 25 5 = 50 1 = 100 2 = 200 A = 250	R = X7R	5 = Multilayer	T = 100% Matte Sn H = SnPb (60/40)	A = N/A	Blank = Bulk 7200 = 12" Reel 7293 = Ammo Pack

¹ Additional capacitance tolerance offerings may be available. Contact KEMET for details.

² Lead materials:

Standard: 100% matte tin (Sn) with nickel (Ni) underplate and steel core ("T" designation).

Alternative 1: 60% tin (Sn)/40% lead (Pb) finish with copper-clad steel core ("H" designation).

Alternative 2: 60% tin (Sn)/40% lead (Pb) finish with 100% copper core (available with "H" designation code with C-Spec).

Contact KEMET for C-Spec details.

Applications

Typical applications include decoupling, bypass, filtering and transient voltage suppression.

Application Notes

These devices are not recommended for use in overmold applications and/or processes.

Dimensions – Inches (Millimeters)

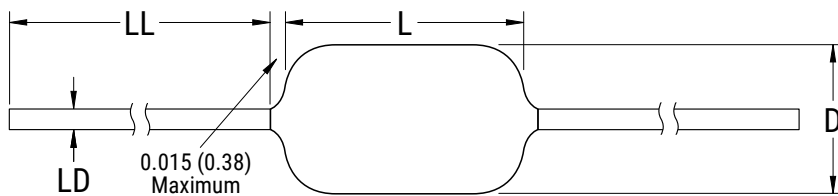

Series	Style/ Size	L Length Maximum	D Diameter Maximum	LD Lead Diameter	LL Lead Length Minimum
C41X	410	0.170 (4.32)	0.095 (2.41)	0.020+0.001/-0.003 (0.51+0.025/-0.076)	1.0 (25.4)
	412	0.170 (4.32)	0.120 (3.05)		
C42X	420	0.200 (5.08)	0.100 (2.54)		
C43X	430	0.240 (6.10)	0.150 (3.81)		
C44X	440	0.260 (6.60)	0.150 (3.81)		

Qualification/Certification

Commercial Grade products are subject to internal qualification. Details regarding test methods and conditions are referenced in Table 2, Performance & Reliability.

Environmental Compliance

Lead (Pb)-free, REACH and RoHS compliant without exemptions when ordered with a 100% tin (Sn) wire lead finish. Product ordered with tin/ lead (Sn60/Pb40) wire lead finish do not meet RoHS criteria.

Series	Termination Finish (Wire Lead)	RoHS Compliant	RoHS Exemption Code	REACH Compliant ¹	Halogen Free
400 (C4XX)	100% Matte Sn	Yes	n/a	Yes	Yes
	Sn60/Pb40	No	n/a	Yes	Yes

¹ REACH compliance indicates product does not contain Substance/s of Very High Concern (SVHC)

Electrical Parameters/Characteristics

Item	Parameters/Characteristics
Operating Temperature Range	-55°C to +125°C
Capacitance Change with Reference to +25°C and 0 VDC Applied (TCC)	±15%
Aging Rate (Maximum % Cap Loss/Decade Hour)	3.0%
Dielectric Withstanding Voltage	250% of rated voltage (5±1 second and charge/discharge not exceeding 50 mA at 25°C)
Dissipation Factor (DF) Maximum Limit at 25°C	See Dissipation Factor Limit Table
Insulation Resistance (IR) Limit at 25°C	See Insulation Resistance Limit Table (Rated voltage applied for 120±5 seconds at 25°C)

Regarding aging rate: Capacitance measurements (including tolerance) are indexed to a referee time of 1,000 hours.

To obtain IR limit, divide $M\Omega \cdot \mu F$ value by the capacitance and compare to $G\Omega$ limit. Select the lower of the two limits.

Capacitance and dissipation factor (DF) measured under the following conditions:

1 kHz ±50 Hz and $1.0 \pm 0.2 V_{rms}$ if capacitance ≤ 10 μF

120 Hz ±10 Hz and $0.5 \pm 0.1 V_{rms}$ if capacitance > 10 μF

Note: When measuring capacitance it is important to ensure the set voltage level is held constant. The HP4284 and Agilent E4980 have a feature known as Automatic Level Control (ALC). The ALC feature should be switched to "ON."

Insulation Resistance Limit Table

Style/Size	1,000 megohm microfarads or 100GΩ	500 megohm microfarads or 10GΩ
410	< 0.15μF	≥ 0.15μF
412	< 0.15μF	≥ 0.15μF
420	< 0.47μF	≥ 0.47μF
430	< 0.47μF	≥ 0.47μF
440	< 0.47μF	≥ 0.47μF

Post Environmental Limits

High Temperature Life, Biased Humidity and Storage Life					
Style/Size	Rated DC Voltage	Capacitance Value	Dissipation Factor (Maximum %)	Capacitance Shift	Insulation Resistance
C410	>25	< 1.0μF	3.0	± 20%	10% of Initial Limit
		≥ 1.0 μF	20.0		
	25	< 2.2 μF	5.0		
		≥ 2.2 μF	20.0		
C412, C420, C440	>25	All	3.0		
	25		5.0		
C430	>25	All	3.0		
	25	< 10.0μF	5.0		
		≥ 10.0 μF	20.0		

Dissipation Factor (DF) Limit Table

Style/Size	Rated DC Voltage	Rated Capacitance	Dissipation Factor (Maximum %)
C410	25	< 2.2 μF	3.5
		≥ 2.2 μF	10.0
	> 25	< 1.0 μF	2.5
		≥ 1.0 μF	10.0
C412, C420, C440	25	All	3.5
	> 25		2.5
C430	25	< 10.0 μF	3.5
		≥ 10.0 μF	10.0
	> 25	All	2.5

Table 1A – C410 Style/Size, Capacitance Range Waterfall

C410 Style/Size (0.095" Diameter x 0.170" Length)						
Rated Voltage (VDC)		25	50	100	200	250
Voltage Code		3	5	1	2	A
Capacitance	Capacitance Tolerance	Capacitance Code (Available Capacitance)				
10pF	J = ±5% K = ±10% M = ±20%	100	100	100	100	100
12pF		120	120	120	120	120
15pF		150	150	150	150	150
18pF		180	180	180	180	180
22pF		220	220	220	220	220
27pF		270	270	270	270	270
33pF		330	330	330	330	330
39pF		390	390	390	390	390
47pF		470	470	470	470	470
56pF		560	560	560	560	560
68pF		680	680	680	680	680
82pF		820	820	820	820	820
100pF		101	101	101	101	101
120pF		121	121	121	121	121
150pF		151	151	151	151	151
180pF		181	181	181	181	181
220pF		221	221	221	221	221
270pF		271	271	271	271	271
330pF		331	331	331	331	331
390pF		391	391	391	391	391
470pF		471	471	471	471	471
560pF		561	561	561	561	561
680pF		681	681	681	681	681
820pF		821	821	821	821	821
1000pF		102	102	102	102	102
1200pF		122	122	122	122	122
1500pF		152	152	152	152	152
1800pF		182	182	182	182	182
2200pF		222	222	222	222	222
2700pF		272	272	272	272	272
3300pF		332	332	332	332	332
3900pF		392	392	392	392	392
4700pF		472	472	472	472	472
5600pF		562	562	562	562	562
6800pF		682	682	682	682	682
8200pF		822	822	822	822	822
0.01µF		103	103	103	103	103
0.012µF		123	123	123	123	123
0.015µF		153	153	153	153	153
0.018µF		183	183	183	183	183
0.022µF		223	223	223	223	223
0.027µF		273	273	273	273	273
0.033µF		333	333	333	333	333
0.039µF		393	393	393	393	393
0.047µF		473	473	473	473	473
0.056µF	563	563	563	563	563	
0.068µF	683	683	683	683	683	
0.082µF	823	823	823	823	823	
0.1µF	104	104	104	104	104	
0.12µF	124	124	124	124	124	
0.15µF	154	154	154	154	154	
0.18µF	184	184	184	184	184	
0.22µF	224	224	224	224	224	
0.27µF	274	274	274	274	274	
0.33µF	334	334	334	334	334	
0.39µF	394	394	394	394	394	
0.47µF	474	474	474	474	474	
0.56µF	564	564	564	564	564	
Rated Voltage (VDC)		25	50	100	200	250
Voltage Code		3	5	1	2	A

Table 1A – C410 Style/Size, Capacitance Range Waterfall cont'd

C410 Style/Size (0.095" Diameter x 0.170" Length)						
Rated Voltage (VDC)		25	50	100	200	250
Voltage Code		3	5	1	2	A
Capacitance	Capacitance Tolerance	Capacitance Code (Available Capacitance)				
0.68µF	J = ±5% K = ±10% M = ±20%	684	684			
0.82µF		824				
1.0µF		105	105			
2.2µF		225				
Rated Voltage (VDC)		25	50	100	200	250
Voltage Code		3	5	1	2	A

Table 1B – C412 Style/Size, Capacitance Range Waterfall

C412 Style/Size (0.120" Diameter x 0.170" Length)						
Rated Voltage (VDC)		25	50	100	200	250
Voltage Code		3	5	1	2	A
Capacitance	Capacitance Tolerance	Capacitance Code (Available Capacitance)				
470pF	J = ±5% K = ±10% M = ±20%	471	471	471	471	471
560pF		561	561	561	561	561
680pF		681	681	681	681	681
820pF		821	821	821	821	821
1000pF		102	102	102	102	102
1200pF		122	122	122	122	122
1500pF		152	152	152	152	152
1800pF		182	182	182	182	182
2200pF		222	222	222	222	222
2700pF		272	272	272	272	272
3300pF		332	332	332	332	332
3900pF		392	392	392	392	392
4700pF		472	472	472	472	472
5600pF		562	562	562	562	562
6800pF		682	682	682	682	682
8200pF		822	822	822	822	822
0.01µF		103	103	103	103	103
0.012µF		123	123	123	123	123
0.015µF		153	153	153	153	153
0.018µF		183	183	183	183	183
0.022µF		223	223	223	223	223
0.027µF		273	273	273	273	273
0.033µF		333	333	333		
0.039µF		393	393	393		
0.047µF		473	473	473		
0.056µF		563	563	563		
0.068µF		683	683	683		
0.082µF		823	823	823		
0.1µF		104	104	104		
0.12µF		124	124	124		
0.15µF		154	154	154		
0.18µF		184	184	184		
0.22µF		224	224	224		
0.27µF		274	274			
0.33µF		334	334			
0.39µF		394	394			
0.47µF		474	474			
0.56µF		564	564			
0.68µF		684	684			
0.82µF		824				
1.0µF	105					
Rated Voltage (VDC)		25	50	100	200	250
Voltage Code		3	5	1	2	A

Table 1C – C420 Style/Size, Capacitance Range Waterfall

C420 Style/Size (0.100" Diameter x 0.200" Length)						
Rated Voltage (VDC)		25	50	100	200	250
Voltage Code		3	5	1	2	A
Capacitance	Capacitance Tolerance	Capacitance Code (Available Capacitance)				
470pF	J = ±5% K = ±10% M = ±20%	471	471	471	471	471
560pF		561	561	561	561	561
680pF		681	681	681	681	681
820pF		821	821	821	821	821
1000pF		102	102	102	102	102
1200pF		122	122	122	122	122
1500pF		152	152	152	152	152
1800pF		182	182	182	182	182
2200pF		222	222	222	222	222
2700pF		272	272	272	272	272
3300pF		332	332	332	332	332
3900pF		392	392	392	392	392
4700pF		472	472	472	472	472
5600pF		562	562	562	562	562
6800pF		682	682	682	682	682
8200pF		822	822	822	822	822
0.01μF		103	103	103	103	103
0.012μF		123	123	123	123	123
0.015μF		153	153	153	153	153
0.018μF		183	183	183	183	183
0.022μF		223	223	223	223	223
0.027μF		273	273	273	273	273
0.033μF		333	333	333	333	333
0.039μF		393	393	393	393	393
0.047μF		473	473	473	473	473
0.056μF		563	563	563	563	563
0.068μF		683	683	683	683	683
0.082μF		823	823	823	823	823
0.1μF		104	104	104	104	104
0.12μF		124	124	124		
0.15μF		154	154	154		
0.18μF		184	184	184		
0.22μF		224	224	224		
0.27μF		274	274	274		
0.33μF		334	334	334		
0.39μF		394	394	394		
0.47μF		474	474	474		
0.56μF		564	564			
0.68μF		684	684			
0.82μF		824	824			
1.0μF	105	105				
Rated Voltage (VDC)		25	50	100	200	250
Voltage Code		3	5	1	2	A

Table 1D – C430 Style/Size, Capacitance Range Waterfall

C430 Style/Size (0.150" Diameter x 0.240" Length)						
Rated Voltage (VDC)		25	50	100	200	250
Voltage Code		3	5	1	2	A
Capacitance	Capacitance Tolerance	Capacitance Code (Available Capacitance)				
0.022µF	J = ±5% K = ±10% M = ±20%	223	223	223	223	223
0.027µF		273	273	273	273	273
0.033µF		333	333	333	333	333
0.039µF		393	393	393	393	393
0.047µF		473	473	473	473	473
0.056µF		563	563	563	563	563
0.068µF		683	683	683	683	683
0.082µF		823	823	823	823	823
0.1µF		104	104	104	104	104
0.12µF		124	124	124	124	124
0.15µF		154	154	154	154	154
0.18µF		184	184	184		
0.22µF		224	224	224		
0.27µF		274	274	274		
0.33µF		334	334	334		
0.39µF		394	394	394		
0.47µF		474	474	474		
0.56µF		564	564			
0.68µF		684	684			
0.82µF		824	824			
1.0µF		105	105			
1.2µF		125	125			
1.5µF		155	155			
1.8µF		185	185			
2.0µF		205	205			
2.2µF		225	225			
2.7µF		275				
3.3µF		335				
3.9µF	395					
4.7µF	475					
10µF	106*					
Rated Voltage (VDC)		25	50	100	200	250
Voltage Code		3	5	1	2	A

* Only available on K and M tolerances.

Table 1E – C440 Style/Size, Capacitance Range Waterfall

C440 Style/Size (0.150" Diameter x 0.260" Length)						
Rated Voltage (VDC)		25	50	100	200	250
Voltage Code		3	5	1	2	A
Capacitance	Capacitance Tolerance	Capacitance Code (Available Capacitance)				
0.033μF	J = ±5% K = ±10% M = ±20%	333	333	333	333	333
0.039μF		393	393	393	393	393
0.047μF		473	473	473	473	473
0.056μF		563	563	563	563	563
0.068μF		683	683	683	683	683
0.082μF		823	823	823	823	823
0.1μF		104	104	104	104	104
0.12μF		124	124	124	124	124
0.15μF		154	154	154		
0.18μF		184	184	184		
0.22μF		224	224	224		
0.27μF		274	274	274		
0.33μF		334	334	334		
0.39μF		394	394	394		
0.47μF		474	474	474		
0.56μF		564	564			
0.68μF		684	684			
0.82μF		824	824			
1.0μF		105	105			
1.2μF		125	125			
1.5μF		155	155			
1.8μF		185	185			
2.0μF		205	205			
2.2μF		225	225			
2.7μF		275				
3.3μF	335					
3.9μF	395					
4.7μF	475					
Rated Voltage (VDC)		25	50	100	200	250
Voltage Code		3	5	1	2	A

Soldering Process

Recommended Soldering Methods:

- Solder Wave
- Hand Soldering (Manual)

Recommended Soldering Profile:

- Optimum Wave Solder Profile

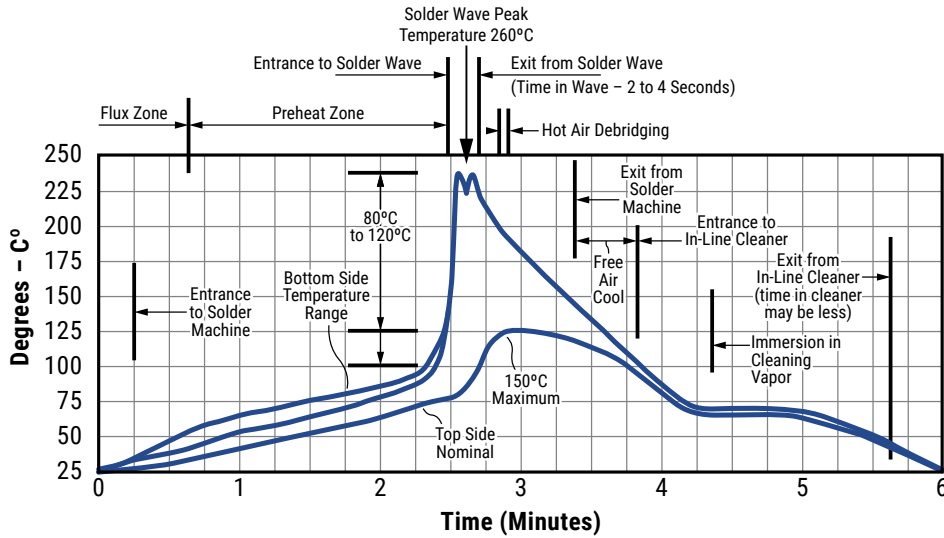

Mounting

All encased capacitors will pass the Resistance to Soldering Heat of MIL-STD-202, Method 210, Condition C. This test simulates wave solder topside board mount product. This demonstration of resistance to solder heat is in accordance with what is believed to be the industry standard. More severe treatment must be considered reflective of an improper soldering process.

The above figure is a recommended solder wave profile for both axial and radial leaded ceramic capacitors.

- Hand Soldering (Manual)

Manual Solder Profile with Pre-heating

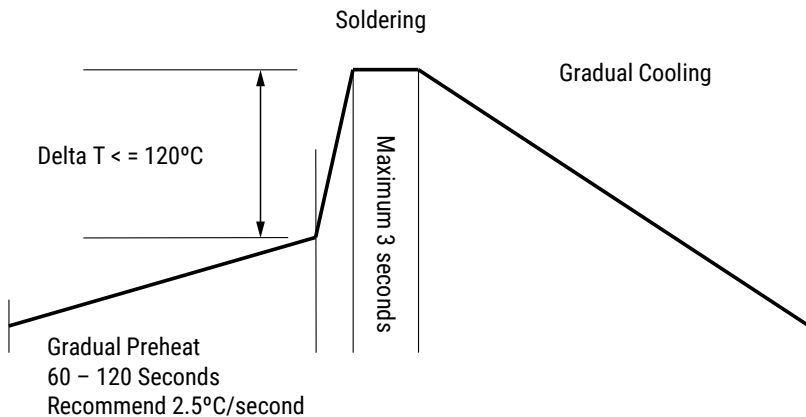

Table 2 – Performance & Reliability: Test Methods and Conditions

Stress	Reference	Test or Inspection Method
Solderability	J-STD-002	Magnification 50X. Conditions: a) Method A, at 235°C, Category 3
Temperature Cycling	JESD22 Method JA-104	5 cycles (-55°C to +125°C), measurement at 24 hours +/-4 hours after test conclusion.
Biased Humidity	MIL-STD-202 Method 103	Load humidity, 1,000 hours 85°C/85%RH and rated voltage. Add 100 K ohm resistor. Measurement at 24 hours +/-4 hours after test conclusion.
		Low volt humidity, 1,000 hours 85°C/85%RH and 1.5 V. Add 100 K ohm resistor. Measurement at 24 hours +/-4 hours after test conclusion.
Moisture Resistance	MIL-STD-202 Method 106	t = 24 hours/cycle. Steps 7a & 7b not required. Unpowered. Measurement at 24 hours +/-4 hours after test conclusion.
Thermal Shock	MIL-STD-202 Method 107	-55°C to +125°C. Note: Number of cycles required = 300. Maximum transfer time = 20 seconds. Dwell time -15 minutes. Air – Air.
High Temperature Life	MIL-STD-202 Method 108 / EIA -198	1,000 hours at 125°C (85°C for Z5U) with 1 X rated voltage applied.
Storage Life	MIL-STD-202 Method 108	125°C, 0 VDC for 1,000 hours.
Vibration	MIL-STD-202 Method 204	5 g for 20 minutes, 12 cycles each of 3 orientations. Note: Use 8"X5" PCB .031" thick 7 secure points on one long side and 2 secure points at corners of opposite sides. Parts mounted within 2" from any secure point. Test from 10-2000 Hz.
Resistance to Soldering Heat	MIL-STD-202 Method 210	Condition B. No preheat of samples. Note: single wave solder – procedure 2.
Terminal Strength	MIL-STD-202 Method 211	Conditions A (454g), Condition C (227g)
Mechanical Shock	MIL-STD-202 Method 213	Figure 1 of Method 213, Condition C.
Resistance to Solvents	MIL-STD-202 Method 215	Add aqueous wash chemical – OKEM Clean or equivalent.

Storage & Handling

The un-mounted storage life of a leaded ceramic capacitor is dependent upon storage and atmospheric conditions as well as packaging materials. While the ceramic chips enveloped under the epoxy coating themselves are quite robust in most environments, solderability of the wire lead on the final epoxy-coated product will be degraded by exposure to high temperatures, high humidity, corrosive atmospheres, and long term storage. In addition, packaging materials will be degraded by high temperature and exposure to direct sunlight—reels may soften or warp, and tape peel force may increase.

KEMET recommends storing the un-mounted capacitors in their original packaging, in a location away from direct sunlight, and where the temperature and relative humidity do not exceed 40 degrees centigrade and 70% respectively. For optimum solderability, capacitor stock should be used promptly, preferably within 18 months of receipt. For applications requiring pre-tinning of components, storage life may be extended if solderability is verified. Before cleaning, bonding or molding these devices, it is important to verify that your process does not affect product quality and performance. KEMET recommends testing and evaluating the performance of a cleaned, bonded or molded product prior to implementing and/or qualifying any of these processes.

Construction

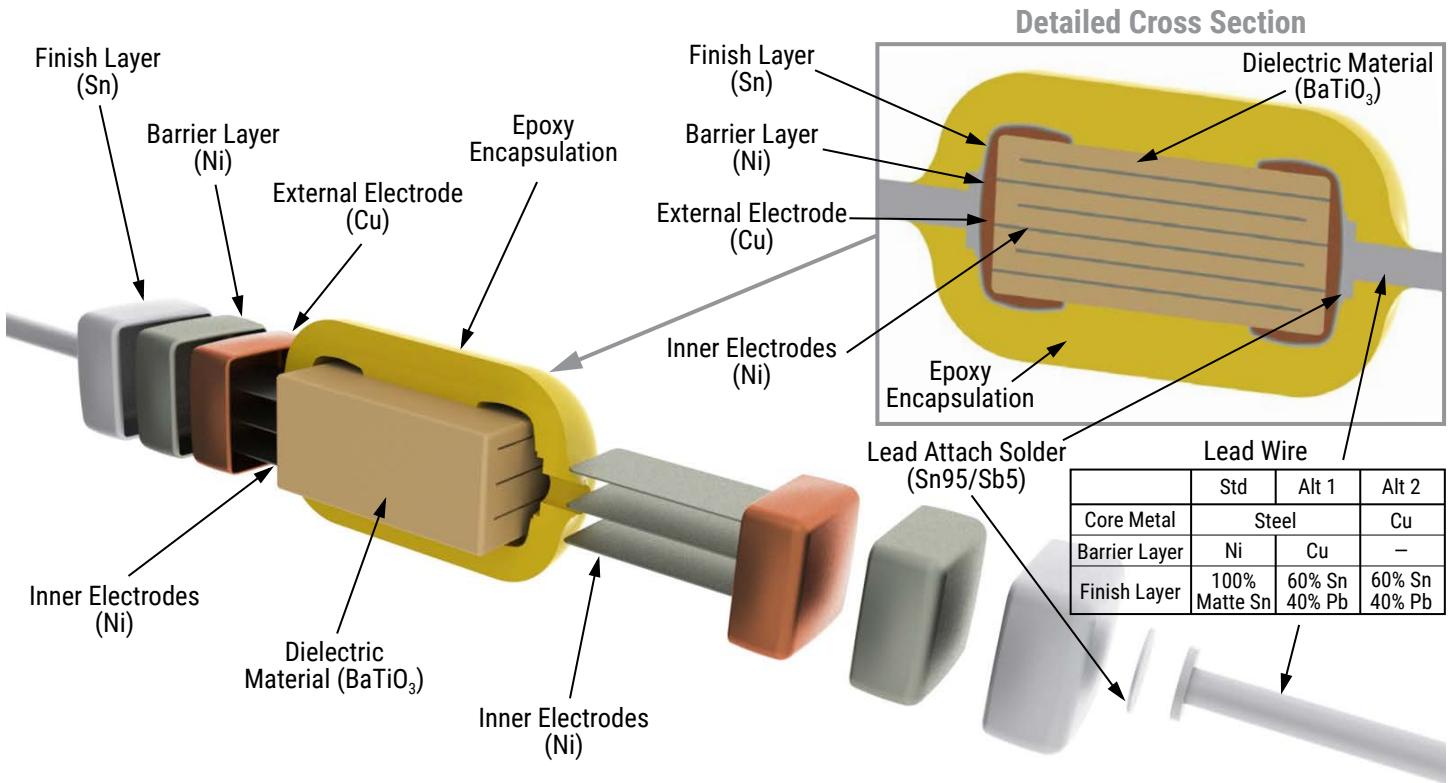

Marking

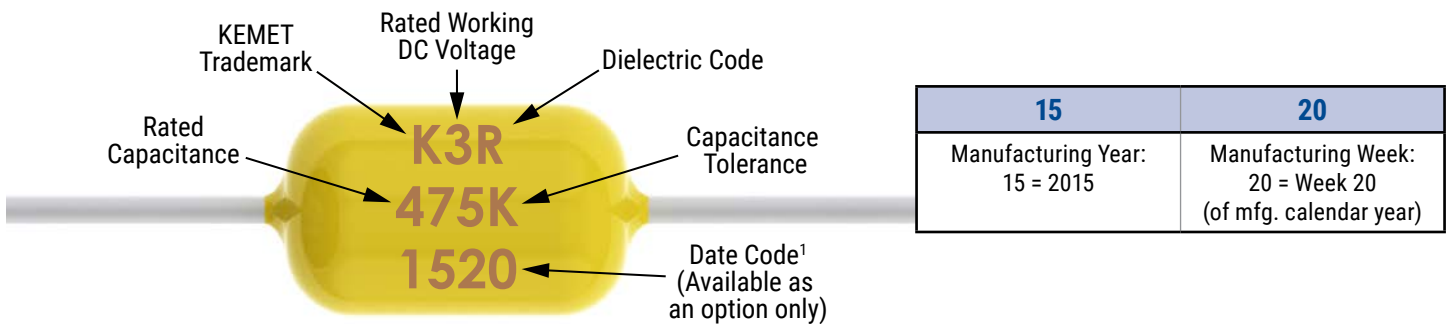

¹ To properly request the inclusion of the date code in the marking, ordering code please contact your KEMET representative.

Packaging Quantities

Style/Size	Standard Bulk Quantity	Ammo Pack Quantity Maximum	Reel Quantity Maximum (12" Reel)
410	300/Box	4000	5000
412	200/Box		
420	300/Box		
430	200/Box	2000	2500
440	200/Box		

Tape & Reel Packaging Information

KEMET offers standard reeling of molded and conformally coated axial leaded ceramic capacitors for automatic insertion or lead forming machines in accordance with EIA standard 296. KEMET's internal specification four-digit suffix, 7200, is placed at the end of the part number to designate tape and reel packaging, e.g., C410C104Z5U5CA7200.

Paper (50 lb.) test minimum is inserted between the layers of capacitors wound on reels for component pitch $\leq 0.400"$. Capacitor lead length may extend only a maximum of $.0625"$ (1.59 mm) beyond the tapes' edges. Capacitors are centered in a row between the two tapes and will deviate only $\pm 0.031"$ (0.79 mm) from the row center. A minimum of 36" (91.5 cm) leader tape is provided at each finished length of taped components. Universal splicing clips are used to connect the tape.

Figure 1

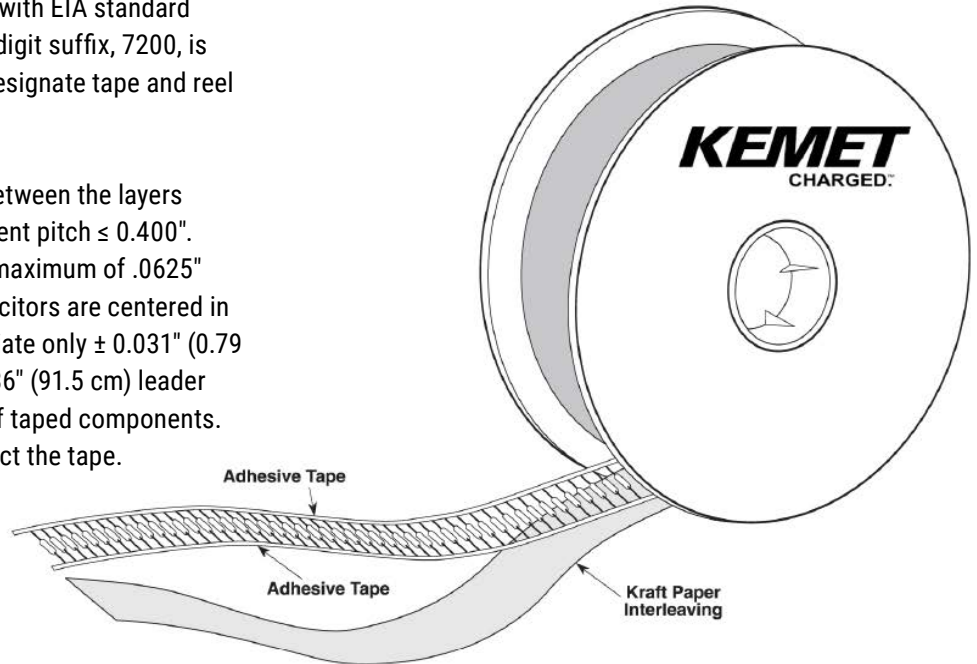

Figure 2

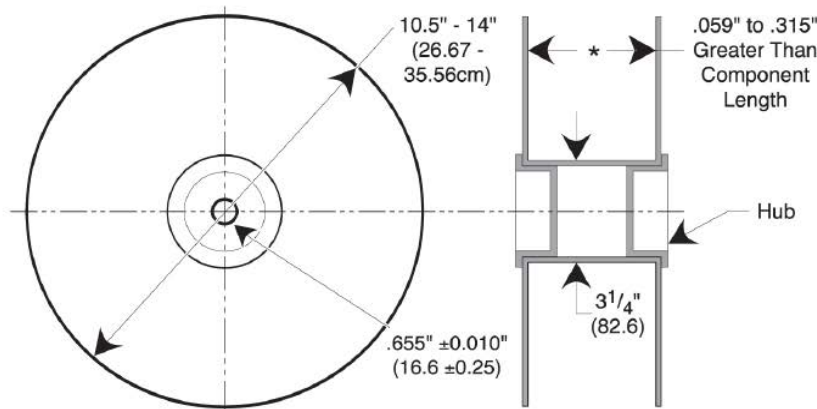

Figure 3

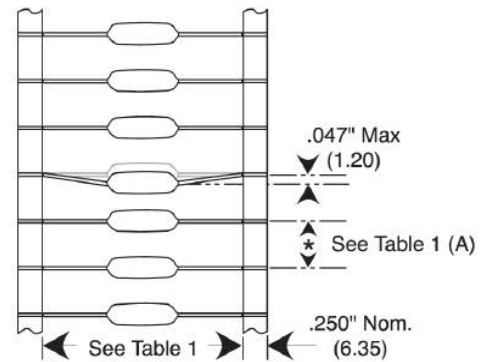

Table 3 – Ceramic Axial Tape and Reel Dimensions

Metric will govern

Dimensions – Millimeters (Inches)		
Axial Capacitor Body Diameter	A	B
	± 0.5 (0.020)	± 1.5 (0.059)*
0.0 to 5.0 (0.0 to 0.197)	5.0 (0.197)	52.4 (2.062)

Symbol Reference Table	
A	Component Pitch
B	Inside Tape Spacing

* Inside tape spacing dimension (B) is determined by the body diameter of the capacitor.

KEMET Electronics Corporation Sales Offices

For a complete list of our global sales offices, please visit www.kemet.com/sales.

Disclaimer

All product specifications, statements, information and data (collectively, the "Information") in this datasheet are subject to change. The customer is responsible for checking and verifying the extent to which the Information contained in this publication is applicable to an order at the time the order is placed.

All Information given herein is believed to be accurate and reliable, but it is presented without guarantee, warranty, or responsibility of any kind, expressed or implied.

Statements of suitability for certain applications are based on KEMET Electronics Corporation's ("KEMET") knowledge of typical operating conditions for such applications, but are not intended to constitute – and KEMET specifically disclaims – any warranty concerning suitability for a specific customer application or use. The Information is intended for use only by customers who have the requisite experience and capability to determine the correct products for their application. Any technical advice inferred from this Information or otherwise provided by KEMET with reference to the use of KEMET's products is given gratis, and KEMET assumes no obligation or liability for the advice given or results obtained.

Although KEMET designs and manufactures its products to the most stringent quality and safety standards, given the current state of the art, isolated component failures may still occur. Accordingly, customer applications which require a high degree of reliability or safety should employ suitable designs or other safeguards (such as installation of protective circuitry or redundancies) in order to ensure that the failure of an electrical component does not result in a risk of personal injury or property damage.

Although all product-related warnings, cautions and notes must be observed, the customer should not assume that all safety measures are indicated or that other measures may not be required.

KEMET is a registered trademark of KEMET Electronics Corporation.

单击下面可查看定价，库存，交付和生命周期等信息

[>>KEMET Electronics\(基美\)](#)