

# EMI Suppression Filters (for DC)/ Chip Inductors for Automotive



## Explanation of category in this catalog

### Infotainment

Info-tainment

The product for entertainment equipment like car navigations, car audios, and body control equipment like wipers, power windows.

### Powertrain, Safety

Power-train

The product for high reliability applications like powertrain and safety, in addition to infotainment applications.

### EU RoHS Compliant

- All the products in this catalog comply with EU RoHS.
- EU RoHS is "the European Directive 2011/65/EU on the Restriction of the Use of Certain Hazardous Substances in Electrical and Electronic Equipment."
- For more details, please refer to our web page, "Murata's Approach for EU RoHS" (<https://www.murata.com/en-eu/support/compliance/rohs>).

Because of the difference of measurement condition, electrical characteristics plots on this catalog may have some difference to official specification value.

# Contents

Product specifications are as of November 2017.

Application Examples ..... p2

## EMI Suppression Filters (for DC)

Contents ..... p7

EMI Suppression Filters (for DC) Product Guide ..... p8

 **Chip Ferrite Bead** ..... p11

 **Chip EMIFIL<sup>®</sup>** ..... p116

 **Chip Common Mode Choke Coil** ..... p140

 **Block Type EMIFIL<sup>®</sup>** ..... p176

 **EMI Suppression Filters (Lead Type)** · p182

 **Microchip Transformer (Balun)** ..... p202

## Chip Inductors

Contents ..... p209

Chip Inductors Product Guide ..... p210

 **Inductors for Power Lines** ..... p212

 **Inductors for General Circuits** ..... p317

 **RF Inductors** ..... p337

Part Number Quick Reference ..... p392

Please check the MURATA website (<https://www.murata.com/>) if you cannot find a part number in this catalog.

# Application Examples

## Car Navigation System

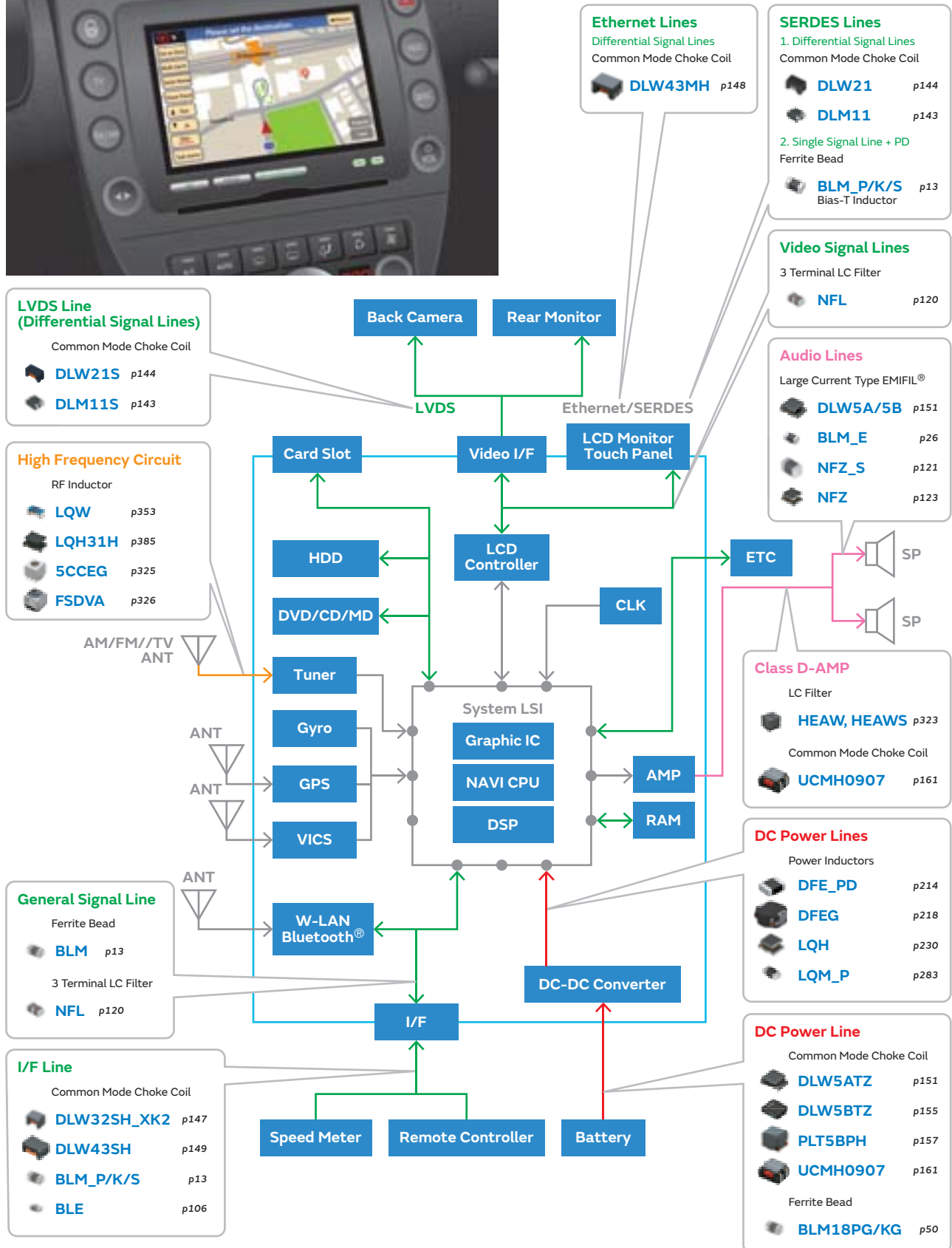

# Application Examples

## Car Camera System

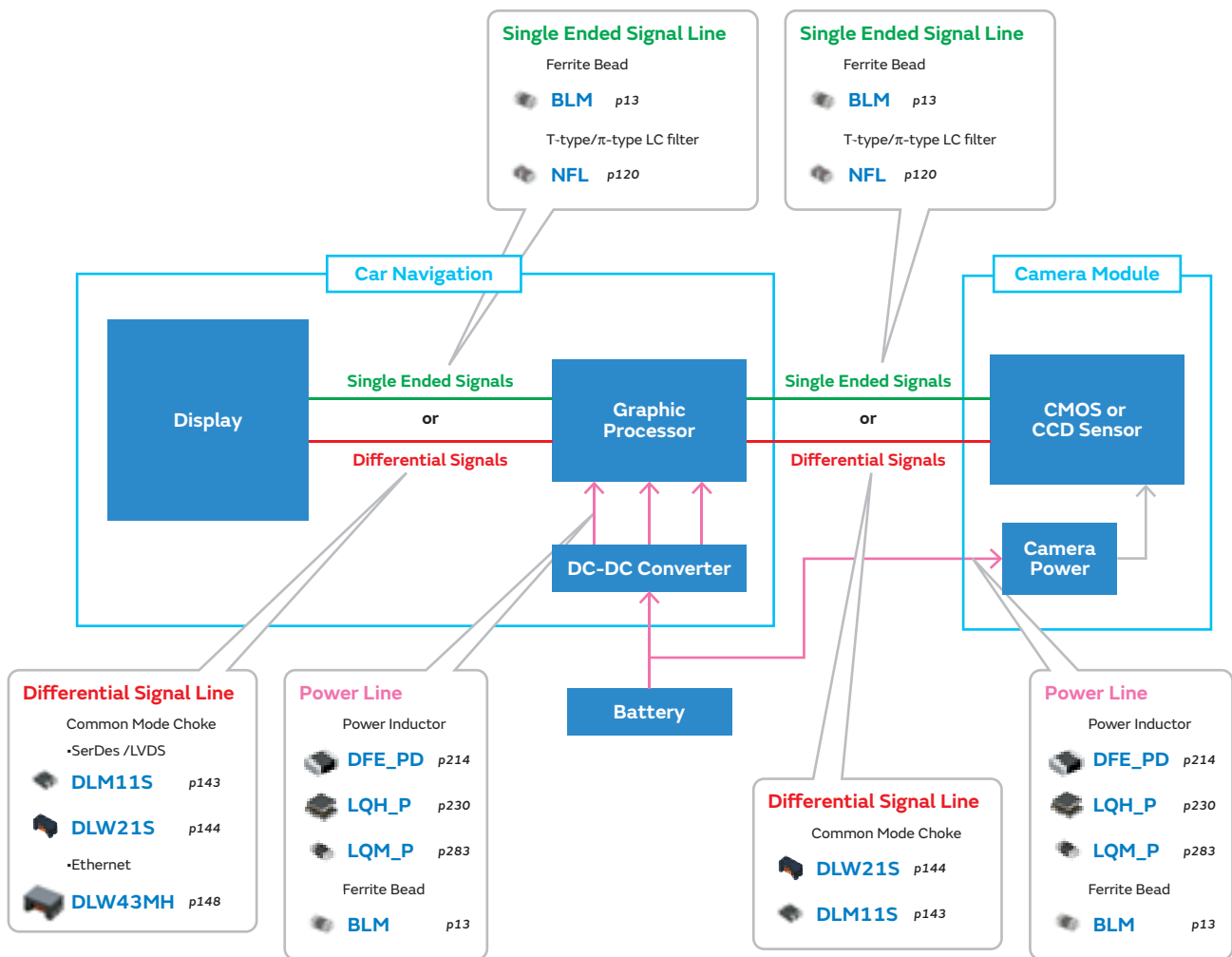

# Application Examples

## Electronic Control Unit

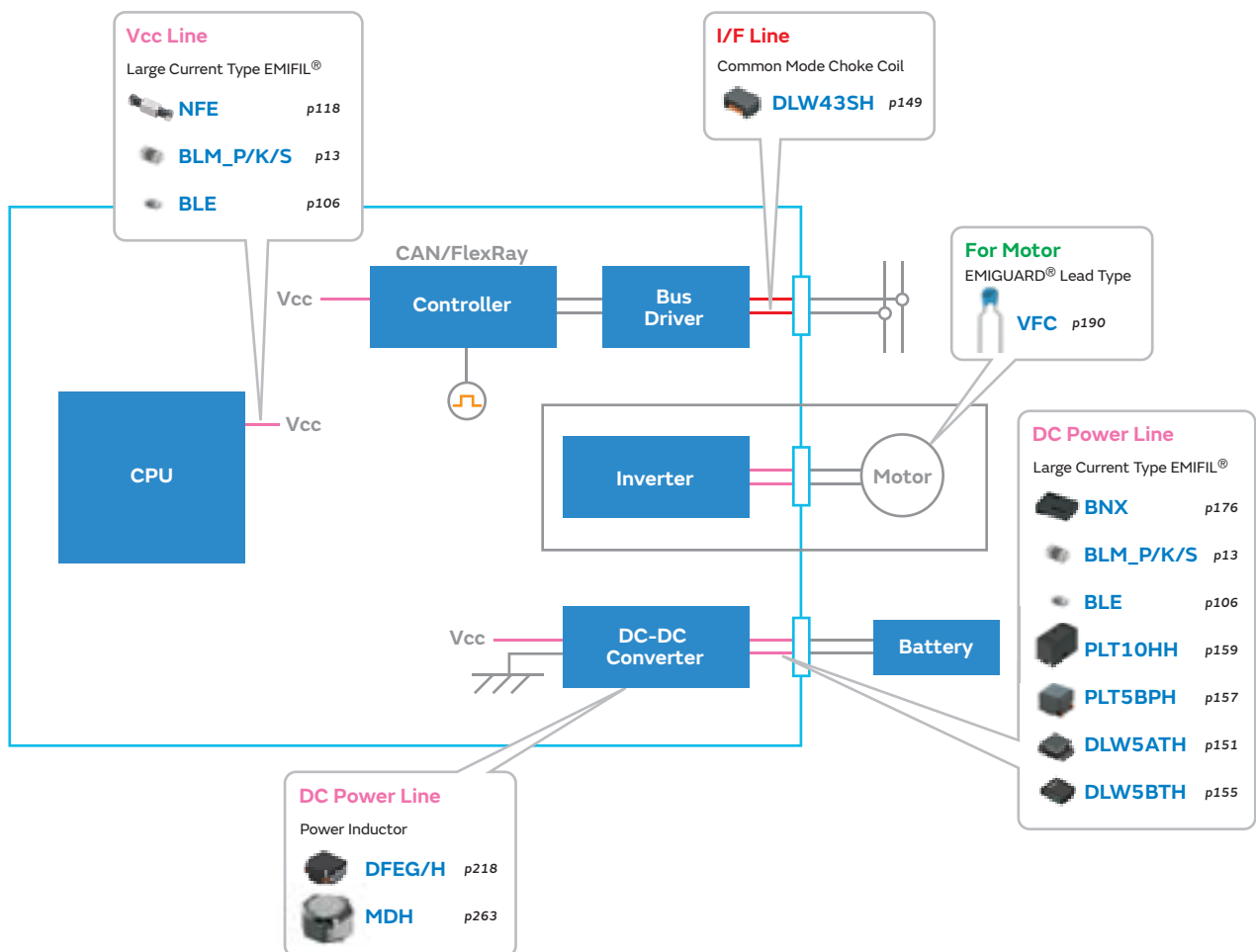

# Application Examples

## Smart Keyless Entry

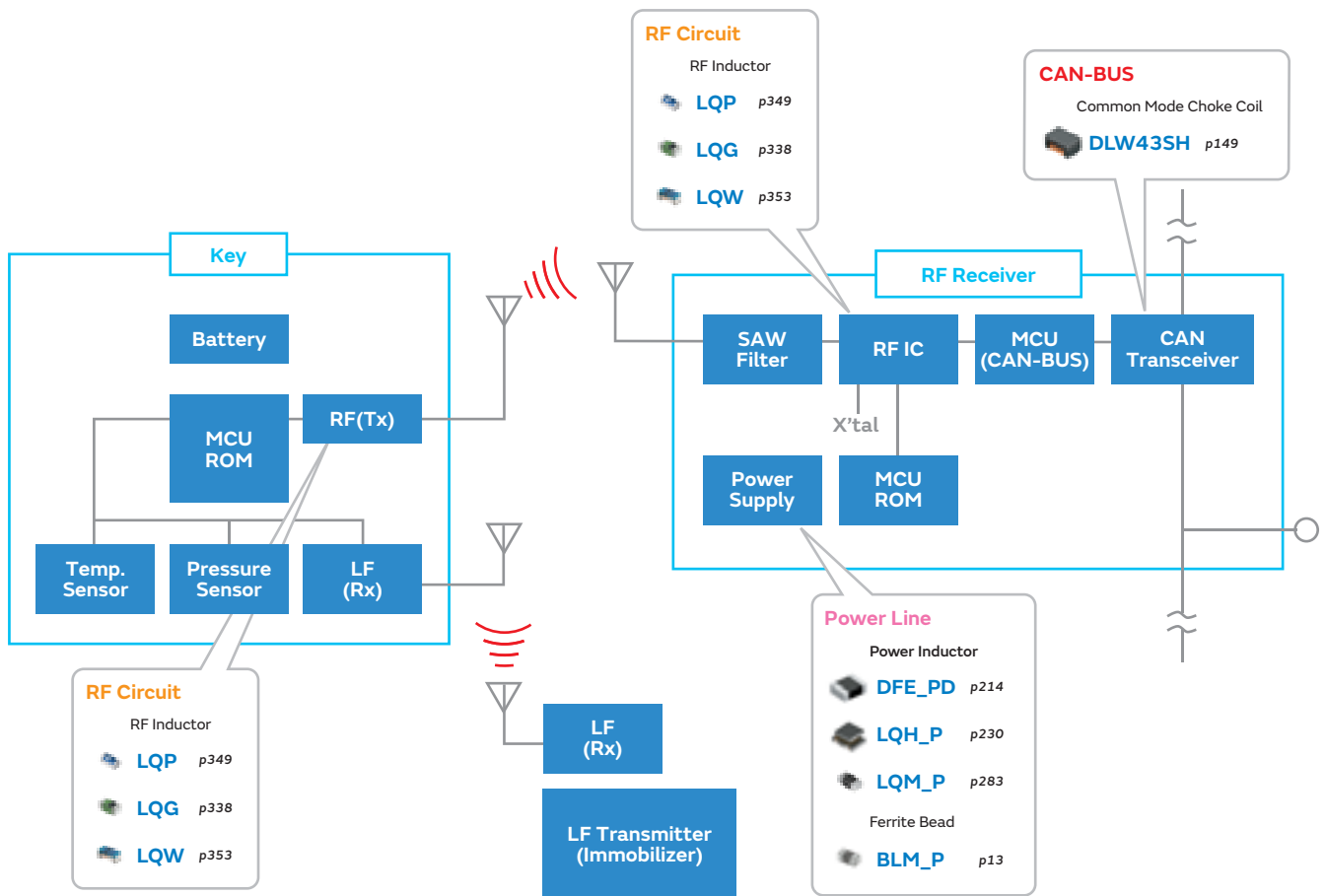

# Application Examples

## Telematics Circuit

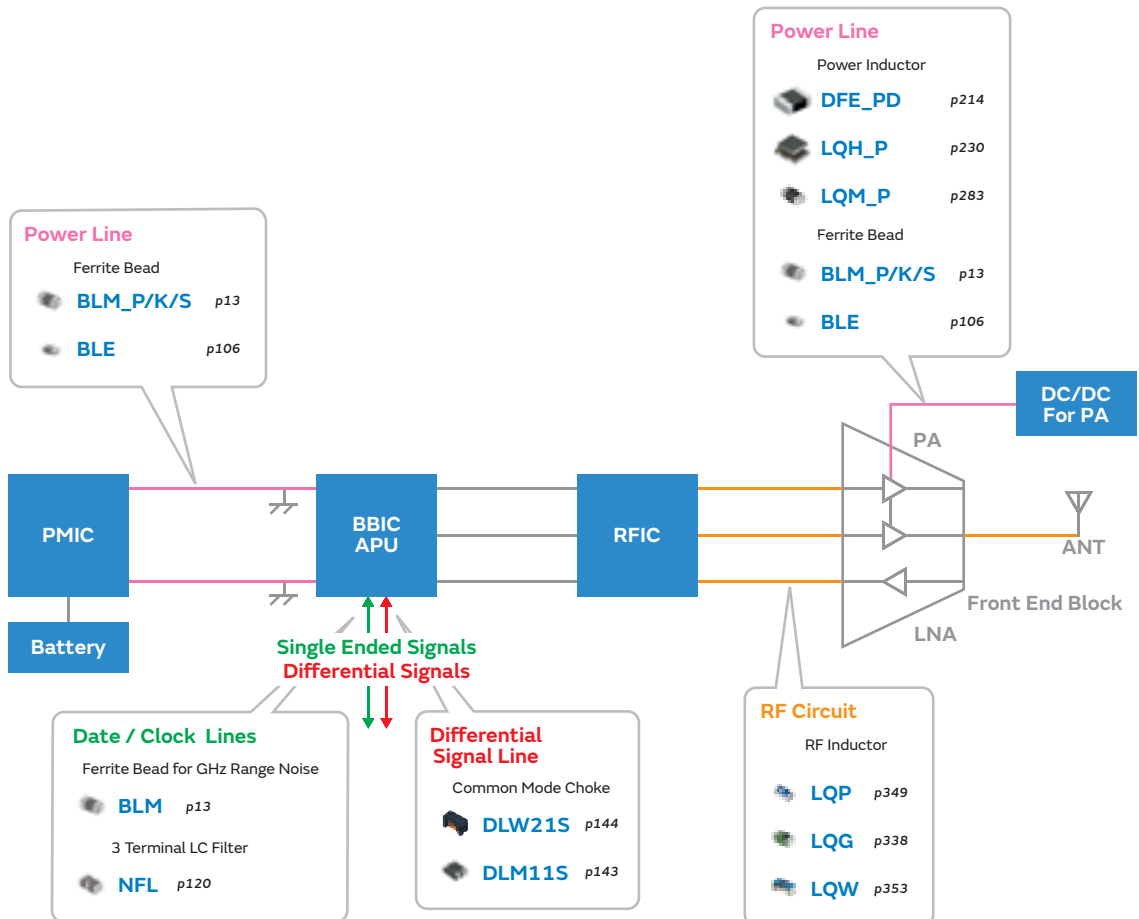



Product Guide ..... p8

**Chip Ferrite Bead**

Part Numbering ..... p11  
 Product Detail ..... p13  
 ⚠️Caution/Notice ..... p109  
 Soldering and Mounting ..... p111  
 Packaging ..... p115

**Chip EMIFIL®**

Part Numbering ..... p116  
 Product Detail ..... p118  
 ⚠️Caution/Notice ..... p132  
 Soldering and Mounting ..... p134  
 Packaging ..... p139

**Chip Common Mode Choke Coil**

Part Numbering ..... p140  
 Product Detail ..... p143  
 ⚠️Caution/Notice ..... p162  
 Soldering and Mounting ..... p166  
 Packaging ..... p173

**Block Type EMIFIL®**

Product Detail ..... p176  
 ⚠️Caution/Notice ..... p178  
 Soldering and Mounting ..... p179  
 Packaging ..... p181

**EMI Suppression Filters (Lead Type)**

Part Numbering ..... p182  
 Product Detail ..... p185  
 ⚠️Caution/Notice ..... p193  
 Soldering and Mounting ..... p196  
 Packaging ..... p200

**Microchip Transformer (Balun)**

Part Numbering ..... p202  
 Product Detail ..... p203  
 ⚠️Caution/Notice ..... p204  
 Soldering and Mounting ..... p205  
 Packaging ..... p207

SMD Type  
 Chip Ferrite Bead

SMD Type  
 Chip EMIFIL®

SMD Type  
 Chip Common Mode Choke Coil

SMD Type  
 Block Type EMIFIL®

Lead Type  
 EMI Suppression Filters

SMD Type  
 Microchip Transformer (Balun)

# Product Guide

## BL Inductor Type

		Series	Applications	Size Code in inch (in mm)	Impedance at 100MHz		
For General Band Noise	Universal Type [ Power Lines / Signal Lines ]	BLM03AX	p16	0201 (0603)	10Ω to 1000Ω		
		BLM15AX	p32	0402 (1005)	10Ω to 1000Ω		
	Signal Lines Type	For General Signal Lines	BLM03AG	p18	0201 (0603)	10Ω to 1000Ω	
			BLM15AG	p34	0402 (1005)	10Ω to 1000Ω	
			BLM18AG	p61	0603 (1608)	120Ω to 1000Ω	
			BLM18AG* (150°C available)	p65	0603 (1608)	120Ω to 1000Ω	
			BLM18AG* (Conductive glue)	p63	0603 (1608)	470Ω to 1000Ω	
		BLM21AG	p88	0805 (2012)	120Ω to 1000Ω		
		BLM21AG* (150°C available)	p90	0805 (2012)	120Ω to 1000Ω		
		BLM31AJ	p103	1206 (3216)	600Ω		
		For High Speed Signal Lines	BLM03B	p20	0201 (0603)	10Ω to 600Ω	
			BLM15B	p36	0402 (1005)	5Ω to 1800Ω	
	BLM18B		p67	0603 (1608)	5Ω to 2500Ω		
	BLM18B* (150°C available)		p72	0603 (1608)	47Ω to 2500Ω		
	BLM21B		p92	0805 (2012)	5Ω to 2700Ω		
	Power Lines Type	BLM03PX*	p13	0201 (0603)	22Ω to 80Ω		
		BLM03PG	p15	0201 (0603)	22Ω to 33Ω		
		BLM15PX*	p28	0402 (1005)	33Ω to 600Ω		
		BLM15PG/PD*	p30	0402 (1005)	10Ω to 120Ω		
		BLM18PG*	p50	0603 (1608)	30Ω to 470Ω		
		BLM21PG*	p83	0805 (2012)	22Ω to 330Ω		
		BLM21PG* (150°C available)	p85	0805 (2012)	22Ω to 330Ω		
		BLM31PG*	p96	1206 (3216)	33Ω to 600Ω		
		BLM41PG*	p104	1806 (4516)	60Ω to 1000Ω		
		BLM18KG* (Low DC Resistance Type)	p55	0603 (1608)	26Ω to 1000Ω		
		BLM18KG* (150°C available)	p58	0603 (1608)	26Ω to 1000Ω		
		BLM31KN*	p98	1206 (3216)	120Ω to 1000Ω		
		BLM31KN* (150°C available)	p100	1206 (3216)	120Ω to 1000Ω		
		BLM18SG* (Low DC Resistance Type)	p52	0603 (1608)	26Ω to 330Ω		
		BLM18SN*	p54	0603 (1608)	22Ω		
		BLM21SN*	p87	0805 (2012)	30Ω		
		BLM31SN*	p102	1206 (3216)	50Ω		
		BLE18PS*	p106	0603 (1608)	8.5Ω		
BLE32PN		p107	1210 (3225)	26Ω to 30Ω			
For GHz Band Noise		Universal Type [ Power Lines / Signal Lines ]	BLM03EB*	p26	0201 (0603)	25Ω to 50Ω	
	BLM15EG*		p47	0402 (1005)	120Ω to 220Ω		
	BLM18EG*		p79	0603 (1608)	100Ω to 600Ω		
	BLM18HE*		p75	0603 (1608)	600Ω to 1500Ω		
	Signal Lines Type	BLM03HG	p23	0201 (0603)	600Ω to 1200Ω		
		BLM03HD	p23	0201 (0603)	330Ω to 1800Ω		
		BLM03HB	p23	0201 (0603)	190Ω to 400Ω		
		BLM15HG	p42	0402 (1005)	600Ω to 1000Ω		
		BLM15HG* (150°C available)	p45	0402 (1005)	600Ω to 1000Ω		
		BLM15HD	p42	0402 (1005)	600Ω to 1800Ω		
		BLM15HB	p42	0402 (1005)	120Ω to 220Ω		
		BLM18HG	p75	0603 (1608)	470Ω to 1000Ω		
		BLM18HD	p75	0603 (1608)	470Ω to 1000Ω		
		BLM18HB	p75	0603 (1608)	120Ω to 330Ω		
		For High-GHz Band Noise	Signal Lines Type	BLM15GG	p49	0402 (1005)	220Ω to 470Ω
				BLM15GA	p49	0402 (1005)	75Ω
				BLM18GG	p82	0603 (1608)	470Ω

\* The derating of rated current is required for some items according to the operating temperature on each product page.

## NF □

Combined Type

	Series	Applications	Size Code in inch (in mm)	Cut-off Frequency
Signal Lines Type	<b>NFL18ZT</b> <small>p120</small>		0603 (1608)	50MHz to 500MHz

Combined Type

	Series	Applications	Size Code in inch (in mm)	Capacitance
Universal Type [ Power Lines / Signal Lines ]	<b>NFE31ZT</b> <small>p118</small>		1206 (3216)	22pF to 2200pF
	<b>NFE61HT</b> <small>p119</small>		2706 (6816)	33pF to 3300pF

Inductor Type

	Series	Applications	Size Code in inch (in mm)	Impedance at 1MHz
For LED Lines	<b>NFZ32BW*</b> <small>p123</small>		1210 (3225)	3.3Ω to 880Ω
	<b>NFZ5BBW*</b> <small>p129</small>		2020 (5050)	2.9Ω to 140Ω

\* The derating of rated current is required for some items according to the operating temperature on each product page.

Inductor Type

	Series	Applications	Size Code in inch (in mm)	Impedance at 100MHz
For Audio Lines	<b>NFZ18SM*</b> <small>p121</small>		0603 (1608)	120Ω to 700Ω

\* The derating of rated current is required for some items according to the operating temperature on each product page.

## DL □

Common Mode Choke Coils

		Series	Applications	Size Code in inch (in mm)	Common Mode Impedance at 100MHz
Signal Lines Type	For Differential Signal Lines	<b>DLM11S</b> <small>p143</small>		0504 (1210)	45Ω to 90Ω
		<b>DLW21S</b> <small>p144</small>		0805 (2012)	67Ω to 490Ω
		<b>DLW31S</b> <small>p146</small>		1206 (3216)	2200Ω
Universal Type [ Power Lines / Signal Lines ]		<b>DLW5BS</b> <small>p154</small>		2020 (5050)	500Ω to 800Ω
		<b>DLW5AT*/DLW5BT*</b> <small>p151</small>		2014 (5036)/2020 (5050)	45Ω to 1400Ω
Power Lines Type		<b>UCMH0907</b> <small>p161</small>		3527 (9070)	700Ω

\* The derating of rated current is required for some items according to the operating temperature on each product page.

Common Mode Choke Coils

	Series	Applications	Size Code in inch (in mm)	Common Mode Inductance at 0.1MHz
For CAN/CAN FD/FlexRay	<b>DLW32SH</b> <small>p147</small>		1210 (3225)	11μH to 100μH
	<b>DLW43MH</b> <small>p148</small>		1812 (4532)	200μH

Common Mode Choke Coils

	Series	Applications	Size Code in inch (in mm)	Common Mode Inductance at 0.1MHz	
Signal Lines Type	For Differential Signal Lines	<b>DLW43S</b> <small>p149</small>		1812 (4532)	11μH to 100μH

Common Mode Choke Coils

	Series	Applications	Size Code in inch (in mm)	Common Mode Inductance at 1MHz	
Signal Lines Type	For Differential Signal Lines	<b>DLW43S</b> <small>p149</small>		1812 (4532)	51μH to 100μH

## PL□

Large Current Common Mode  
 Choke Coil for Automotive Available

	Series	Applications	Size Code in inch (in mm)	Common Mode Impedance at 10MHz
Power Lines Type	<b>PLT10H*</b> p159		-	45Ω to 1000Ω
	<b>PLT5BP*</b> p157		2020 (5050)	100Ω to 500Ω

\* The derating of rated current is required for some items according to the operating temperature on each product page.

## BNX

Block EMIFIL®

		Series	Applications	Height (mm)	Rated Voltage (Vdc)	Rated Current (A)
Power Lines Type	SMD Type	<b>BNX024H01*</b> p176		3.5	50	20
		<b>BNX025H01*</b> p176		3.5	25	20
		<b>BNX026H01*</b> p176		3.5	50	20
		<b>BNX027H01*</b> p176		3.5	16	20
	Lead Type	<b>BNX012H01*</b> p191		8.5 max.	50	15

\* The derating of rated current is required for some items according to the operating temperature on each product page.

## BLL

Leaded Multilayer Ferrite Beads

	Series	Applications	Height (mm)	Impedance at 100MHz
Signal Lines Type	<b>BLL18AG</b> p185		4.0 max.	120Ω to 1000Ω

## DS□

3-Terminal Capacitor Lead Type

	Series	Applications	Height (mm)	Capacitance
Universal Type [ Power Lines / Signal Lines ]	<b>DSS1</b> p187		7.5 max.	22pF to 100nF

## VF□

Lead Type Capacitor  
 with Varistor Function

	Series	Applications	Height (mm)	Capacitance	Varistor Voltage
Power Lines Type	<b>VFC2</b> p190		6.0 max.	1.0μF	27V

## ● Part Numbering

### Chip Ferrite Bead for Automotive

(Part Number) 

BL	M	18	AG	102	S	Z	1	D
①	②	③	④	⑤	⑥	⑦	⑧	⑨

#### ① Product ID

Product ID	
BL	Chip Ferrite Beads

#### ② Type

Code	Type
E	DC Bias Characteristics Improved Type
M	Ferrite Bead Single Type

#### ③ Dimensions (LxW)

Code	Dimensions (LxW)	Size Code (inch)
03	0.6x0.3mm	0201
15	1.0x0.5mm	0402
18	1.6x0.8mm	0603
21	2.0x1.25mm	0805
31	3.2x1.6mm	1206
32	3.2x2.5mm	1210
41	4.5x1.6mm	1806

#### ④ Characteristics/Applications

Code *1	Characteristics/Applications	Series	
AG	For General Use	BLM03/15/18/21	
AJ		BLM31	
AX		BLM03/15	
BA	For High-speed Signal Lines	BLM15/18	
BB		BLM03/15/18/21	
BC		BLM03/15	
BD		BLM03/15/18/21	
BX		BLM15	
KG		BLM18	
KN		BLM31	
PD	For Power Lines	BLM15	
PG		BLM03/15/18/21/31/41	
PN		BLE32	
PS		BLE18	
PX		BLM03/15	
SG		BLM18	
SN		BLM18/21/31	
HG		For GHz Band General Use	BLM03/15/18
EB		For GHz Band High-speed Signal Lines (Low Direct Current Type)	BLM03
EG		For GHz Band General Use (Low DC Resistance Type)	BLM15/18
HB		For GHz Band High-speed Signal Lines	BLM03/15/18
HD	BLM03/15/18		
HE	BLM18		
GA	For High-GHz Band High-speed Signal Lines	BLM15	
GG	For High-GHz Band General Use	BLM15/18	

\*1 Frequency characteristics vary with each code.

Continued on the following page. ↗

#### ⑤ Impedance

Expressed by three figures. The unit is in ohm ( $\Omega$ ) at 100MHz. The first and second figures are significant digits, and the third figure expresses the number of zeros that follow the two figures.

#### ⑥ Electrode

Expressed by a letter.

Ex.)

Code	Electrode
S/F/T/B/J	Sn Plating
A	Au Plating
W	Ag/Pd

#### ⑦ Category

Code	Category	
Z	For Automotive	Infotainment
H		Powertrain, Safety

#### ⑧ Number of Circuits

Code	Number of Circuits
1	1 Circuit

Continued from the preceding page. ↘

⑨Packaging

Code	Packaging	Series
<b>K</b>	Embossed Taping (ø330mm Reel)	<b>BLE32, BLM21<sup>*1</sup>/31A/31K/31P/41</b>
<b>L</b>	Embossed Taping (ø180mm Reel)	<b>BLE32, BLM21<sup>*1</sup>/31/41</b>
<b>B</b>	Bulk	All Series
<b>J</b>	Paper Taping (ø330mm Reel)	<b>BLE18, BLM03/15/18<sup>*2</sup>/21<sup>*3</sup></b>
<b>D</b>	Paper Taping (ø180mm Reel)	<b>BLE18, BLM03/15/18/21<sup>*3</sup></b>

\*1 BLM21BD222S□1/BLM21BD272S□1 only.

\*2 Except for BLM18KG\_JH1/\_BH1/BLM18BD\_BH1/BLM18AG\_BH1

\*3 Except for BLM21BD222S□1/BLM21BD272S□1

Chip Ferrite Bead SMD Type  
 Chip EMIFIL® SMD Type  
 Chip Common Mode Choke Coil SMD Type  
 Block Type EMIFIL® SMD Type  
 EMI Suppression Filters Lead Type  
 Microchip Transformer (Balun) SMD Type

# Chip Ferrite Bead SMD Type

## BLM03PX Series 0201/0603(inch/mm)

### Appearance/Dimensions

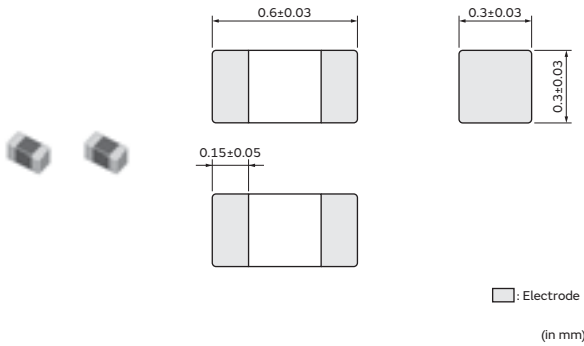

### Packaging

Code	Packaging	Minimum Quantity
D	ø180mm Paper Tape	15000
J	ø330mm Paper Tape	50000
B	Bulk(Bag)	1000

### Equivalent Circuit



(Resistance element becomes dominant at high frequencies.)

### Rated Value (□: packaging code)

Part Number		Impedance at 100MHz	Rated Current at 85°C	Rated Current at 125°C	DC Resistance (Max.)
Infotainment	Powertrain/Safety				
BLM03PX220SZ1□	—	22Ω±25%	1.8A	1.45A	0.04Ω
BLM03PX330SZ1□	—	33Ω±25%	1.5A	1.2A	0.055Ω
BLM03PX800SZ1□	—	80Ω±25%	1A	800mA	0.13Ω

Operating Temp. Range: -55°C to 125°C

### Z-f characteristics: BLM03PX\_SZ1 series

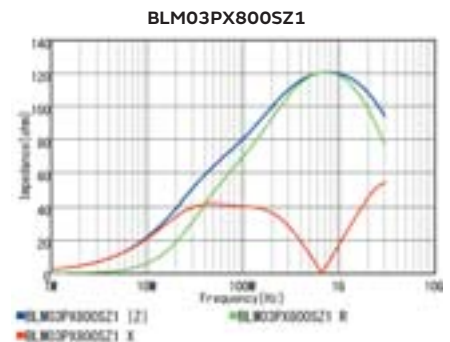
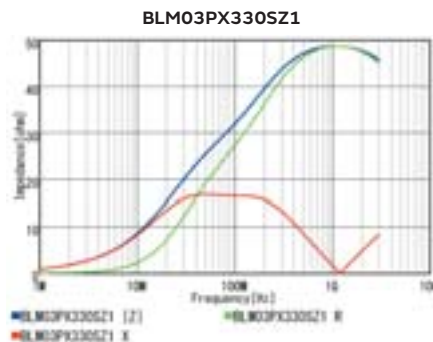
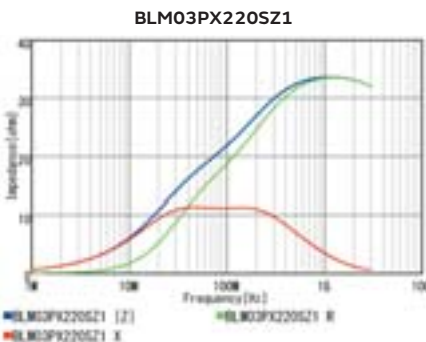
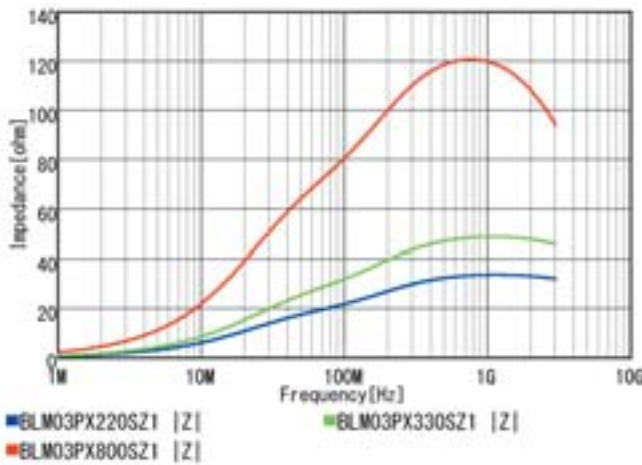

Continued on the following page. ↗

SMD Type  
 Chip Ferrite Bead

SMD Type  
 Chip EMIFIL®

SMD Type  
 Chip Common Mode Choke Coil

SMD Type  
 Block Type EMIFIL®

Lead Type  
 EMI Suppression Filters

SMD Type  
 Microchip Transformer (Balun)

Continued from the preceding page. ↘

## Derating of Rated Current

In operating temperature exceeding +85°C, derating of current is necessary for BLM03PX\_S□1 series. Please apply the derating curve shown in chart according to the operating temperature.

Derating of Rated Current

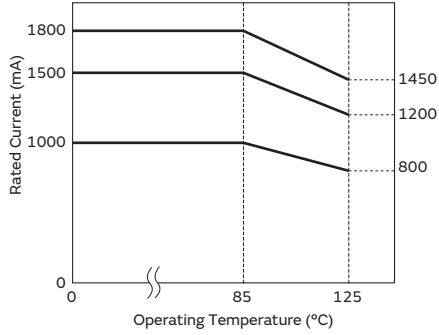

Chip Ferrite Bead  
SMD Type

Chip EMIFIL®  
SMD Type

Chip Common Mode Choke Coil  
SMD Type

Block Type EMIFIL®  
SMD Type

EMI Suppression Filters  
Lead Type

Microchip Transformer (Balun)  
SMD Type



# Chip Ferrite Bead SMD Type

## BLM03PG Series 0201/0603(inch/mm)

### Appearance/Dimensions

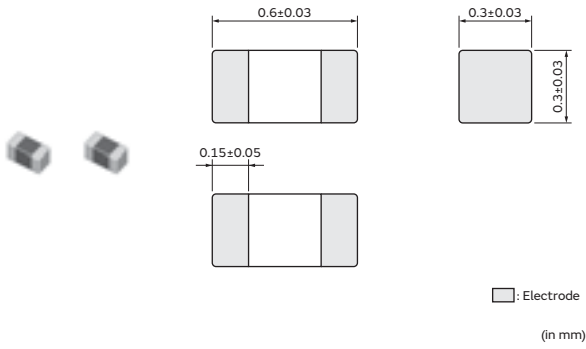

### Packaging

Code	Packaging	Minimum Quantity
D	ø180mm Paper Tape	15000
J	ø330mm Paper Tape	50000
B	Bulk(Bag)	1000

### Equivalent Circuit



(Resistance element becomes dominant at high frequencies.)

### Rated Value (□: packaging code)

Part Number		Impedance at 100MHz	Rated Current at 85°C	Rated Current at 125°C	DC Resistance (Max.)
Infotainment	Powertrain/Safety				
BLM03PG220SZ1□	—	22Ω±25%	900mA	900mA	0.065Ω
BLM03PG330SZ1□	—	33Ω±25%	750mA	750mA	0.09Ω

Operating Temp. Range: -55°C to 125°C

### Z-f characteristics: BLM03PG\_SZ1 series

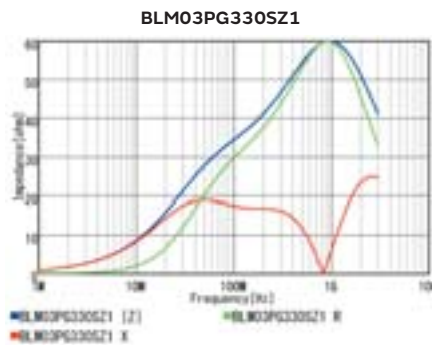
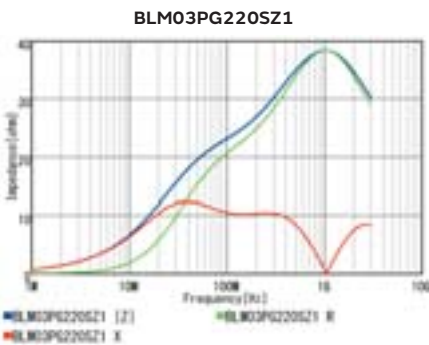
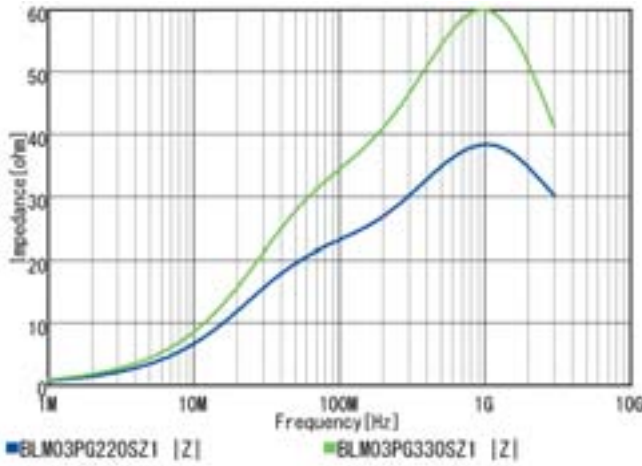

SMD Type  
 Chip Ferrite Bead

SMD Type  
 Chip EMIFIL®

SMD Type  
 Chip Common Mode Choke Coil

SMD Type  
 Block Type EMIFIL®

Lead Type  
 EMI Suppression Filters

SMD Type  
 Microchip Transformer (Balun)

# Chip Ferrite Bead SMD Type

## BLM03AX Series 0201/0603(inch/mm)

### Appearance/Dimensions

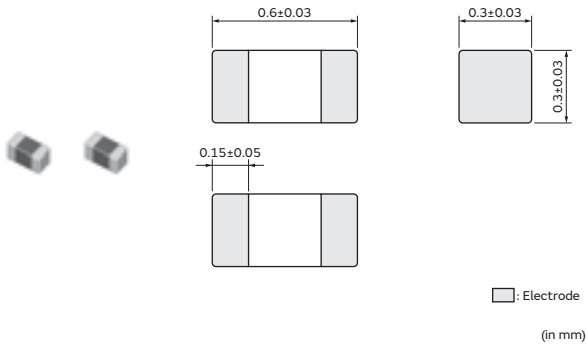

### Packaging

Code	Packaging	Minimum Quantity
D	ø180mm Paper Tape	15000
J	ø330mm Paper Tape	50000
B	Bulk(Bag)	1000

### Equivalent Circuit

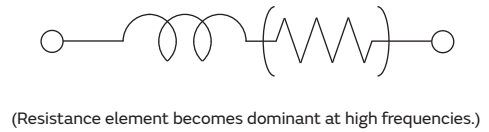

### Rated Value (□: packaging code)

Part Number		Impedance at 100MHz	Rated Current at 85°C	Rated Current at 125°C	DC Resistance (Max.)
Infotainment	Powertrain/Safety				
BLM03AX100SZ1□	—	10Ω(Typ.)	1A	1A	0.05Ω
BLM03AX800SZ1□	—	80Ω±25%	500mA	500mA	0.18Ω
BLM03AX121SZ1□	—	120Ω±25%	450mA	450mA	0.23Ω
BLM03AX241SZ1□	—	240Ω±25%	350mA	350mA	0.38Ω
BLM03AX601SZ1□	—	600Ω±25%	250mA	250mA	0.85Ω
BLM03AX102SZ1□	—	1000Ω±25%	200mA	200mA	1.25Ω

Operating Temp. Range: -55°C to 125°C

### Z-f characteristics: BLM03AX\_SZ1 series

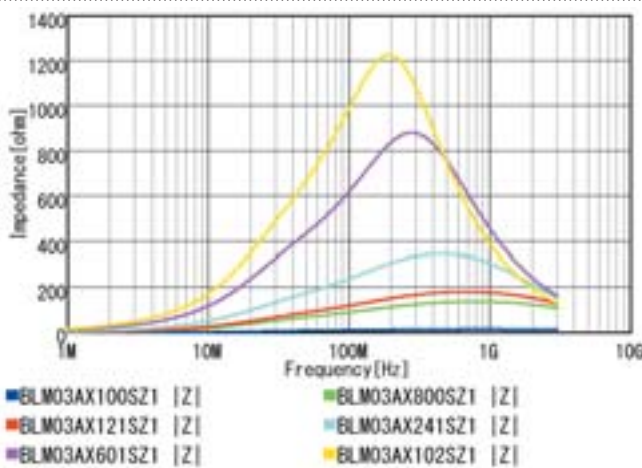

Continued on the following page. ↗

Chip Ferrite Bead SMD Type  
 Chip EMIFIL® SMD Type  
 Chip Common Mode Choke Coil SMD Type  
 Block Type EMIFIL® SMD Type  
 EMI Suppression Filters Lead Type  
 Microchip Transformer (Balun) SMD Type

Continued from the preceding page. ↘

### Z-f characteristics

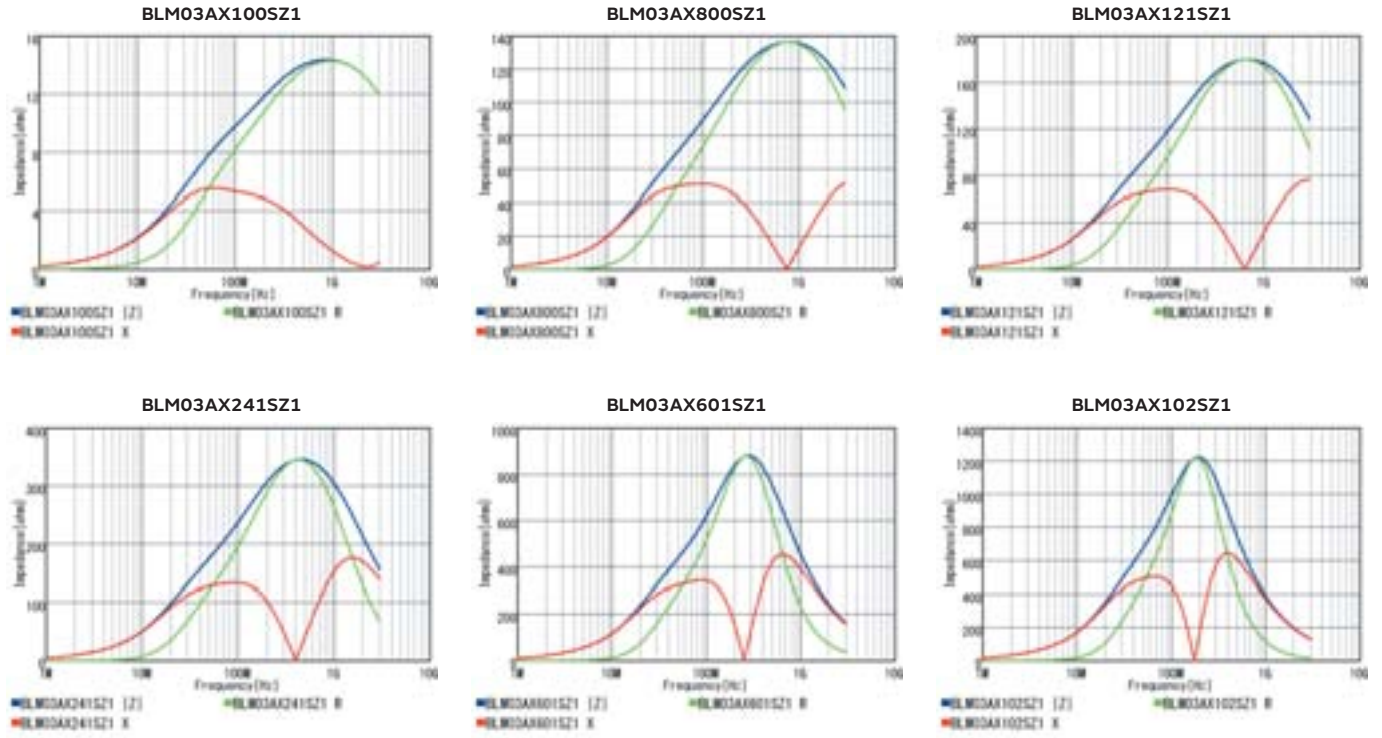

SMD Type  
 Chip Ferrite Bead

SMD Type  
 Chip EMI FIL®

SMD Type  
 Chip Common Mode Choke Coil

SMD Type  
 Block Type EMI FIL®

Lead Type  
 EMI Suppression Filters

SMD Type  
 Microchip Transformer (Balun)

# Chip Ferrite Bead SMD Type

## BLM03AG Series 0201/0603(inch/mm)

### Appearance/Dimensions

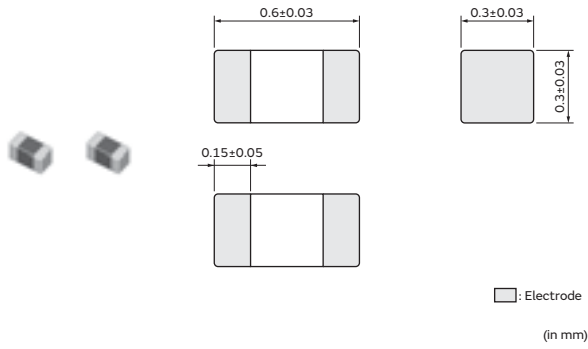

### Packaging

Code	Packaging	Minimum Quantity
D	ø180mm Paper Tape	15000
J	ø330mm Paper Tape	50000
B	Bulk(Bag)	1000

### Equivalent Circuit

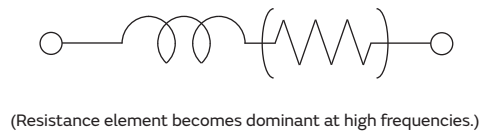

### Rated Value (□: packaging code)

Part Number		Impedance at 100MHz	Rated Current at 85°C	Rated Current at 125°C	DC Resistance (Max.)
Infotainment	Powertrain/Safety				
BLM03AG100SZ1□	—	10Ω(Typ.)	500mA	500mA	0.1Ω
BLM03AG700SZ1□	—	70Ω(Typ.)	200mA	200mA	0.4Ω
BLM03AG800SZ1□	—	80Ω±25%	200mA	200mA	0.4Ω
BLM03AG121SZ1□	—	120Ω±25%	200mA	200mA	0.5Ω
BLM03AG241SZ1□	—	240Ω±25%	200mA	200mA	0.8Ω
BLM03AG601SZ1□	—	600Ω±25%	100mA	100mA	1.5Ω
BLM03AG102SZ1□	—	1000Ω±25%	100mA	100mA	2.5Ω

Operating Temp. Range: -55°C to 125°C

### Z-f characteristics: BLM03AG\_SZ1 series

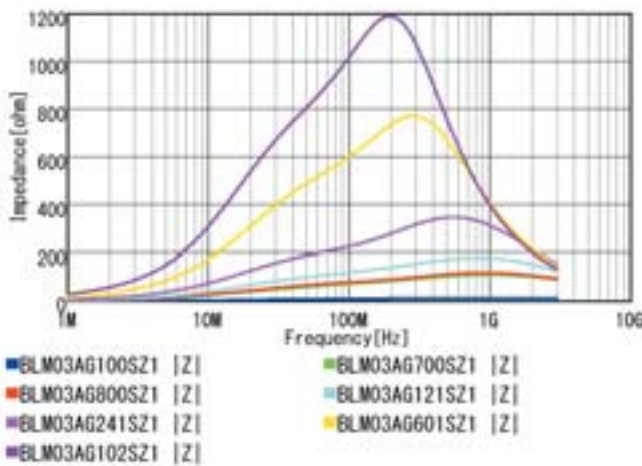

Continued on the following page. ↗

Continued from the preceding page. ↘

**Z-f characteristics**

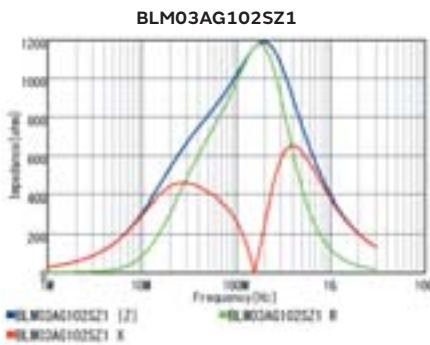
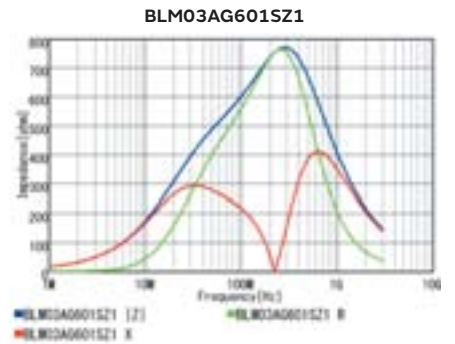
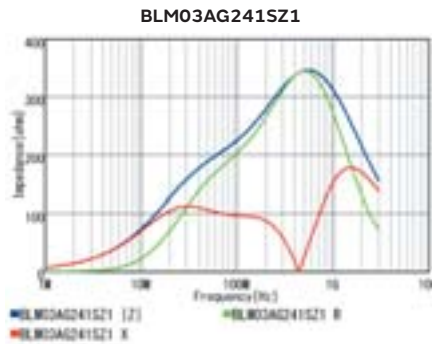
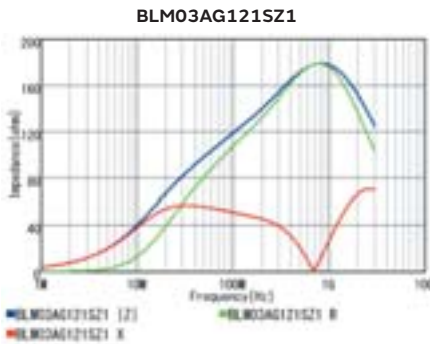
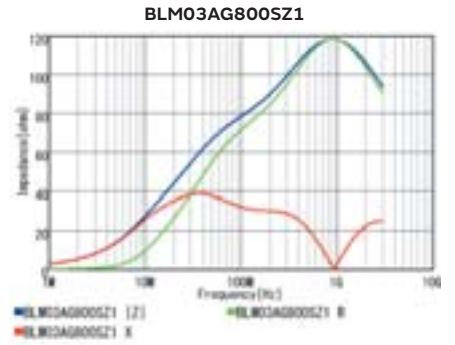
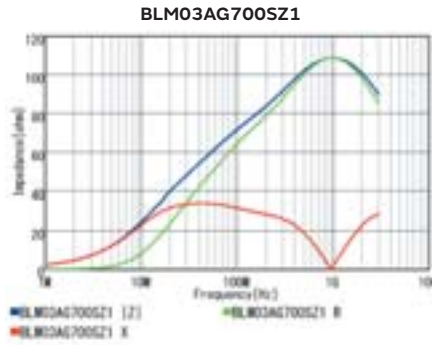
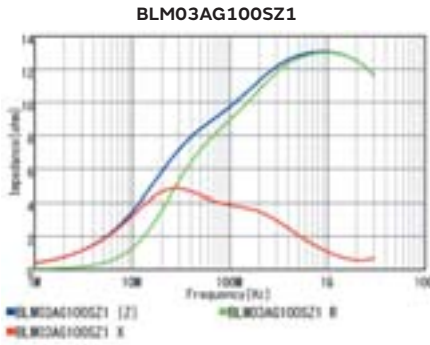

SMD Type  
 Chip Ferrite Bead

SMD Type  
 Chip EMIFIL®

SMD Type  
 Chip Common Mode Choke Coil

SMD Type  
 Block Type EMIFIL®

Lead Type  
 EMI Suppression Filters

SMD Type  
 Microchip Transformer (Balun)

# Chip Ferrite Bead SMD Type

## BLM03BB/BC/BD Series 0201/0603(inch/mm)

### Appearance/Dimensions

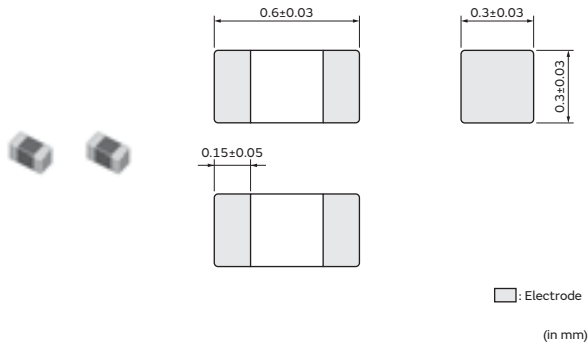

### Packaging

Code	Packaging	Minimum Quantity
D	ø180mm Paper Tape	15000
J	ø330mm Paper Tape	50000
B	Bulk(Bag)	1000

### Equivalent Circuit



(Resistance element becomes dominant at high frequencies.)

### Rated Value (□: packaging code)

Part Number		Impedance at 100MHz	Rated Current at 85°C	Rated Current at 125°C	DC Resistance (Max.)
Infotainment	Powertrain/Safety				
BLM03BB100SZ1□	—	10Ω±25%	300mA	300mA	0.4Ω
BLM03BB220SZ1□	—	22Ω±25%	200mA	200mA	0.5Ω
BLM03BB470SZ1□	—	47Ω±25%	200mA	200mA	0.7Ω
BLM03BB750SZ1□	—	75Ω±25%	200mA	200mA	1Ω
BLM03BB121SZ1□	—	120Ω±25%	100mA	100mA	1.5Ω
BLM03BC330SZ1□	—	33Ω±25%	150mA	150mA	0.85Ω
BLM03BC560SZ1□	—	56Ω±25%	100mA	100mA	1.05Ω
BLM03BC800SZ1□	—	80Ω±25%	100mA	100mA	1.4Ω
BLM03BD750SZ1□	—	75Ω±25%	300mA	300mA	0.4Ω
BLM03BD121SZ1□	—	120Ω±25%	250mA	250mA	0.5Ω
BLM03BD241SZ1□	—	240Ω±25%	200mA	200mA	0.8Ω
BLM03BD471SZ1□	—	470Ω±25%	215mA	215mA	1.5Ω
BLM03BD601SZ1□	—	600Ω±25%	200mA	200mA	1.7Ω

Operating Temp. Range: -55°C to 125°C

### Z-f characteristics: BLM03BB\_SZ1 series

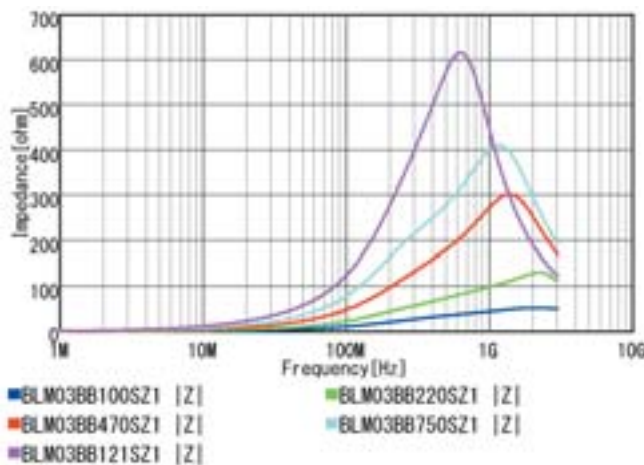

### Z-f characteristics: BLM03BC\_SZ1 series

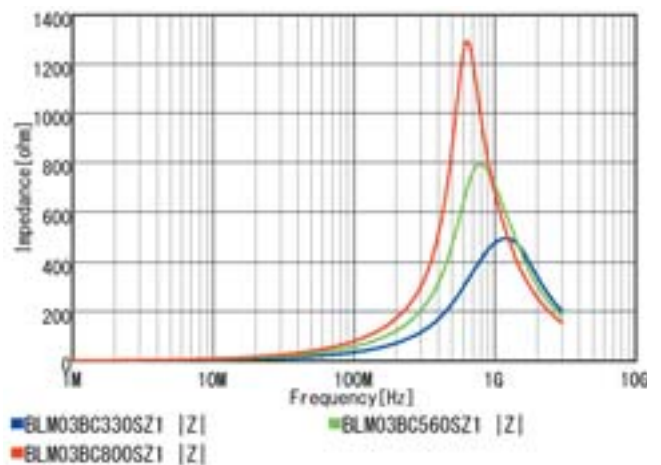

Continued on the following page. ↗

Continued from the preceding page. ↘

**Z-f characteristics: BLM03BD\_SZ1 series**

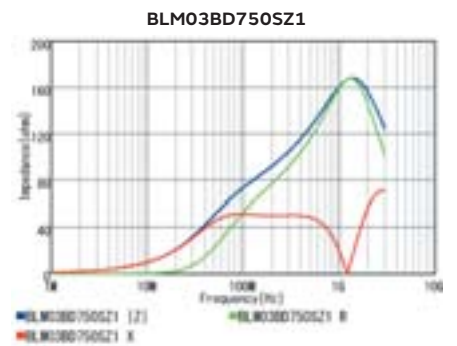
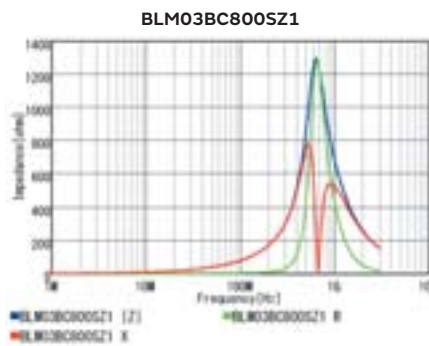
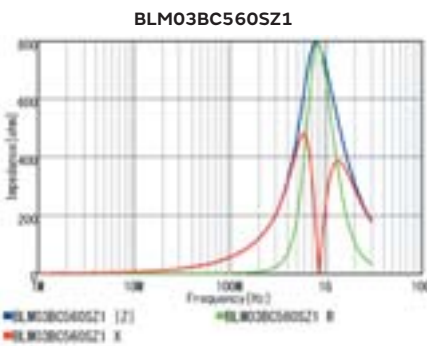
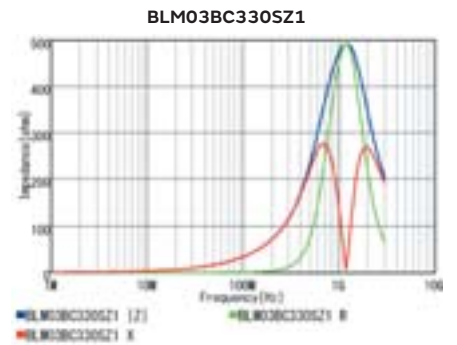
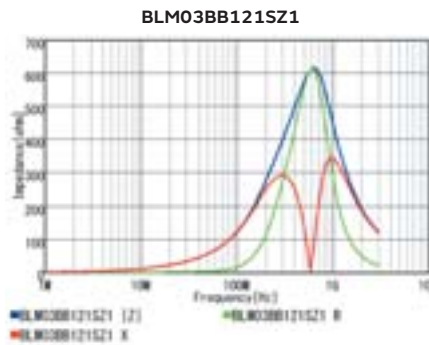
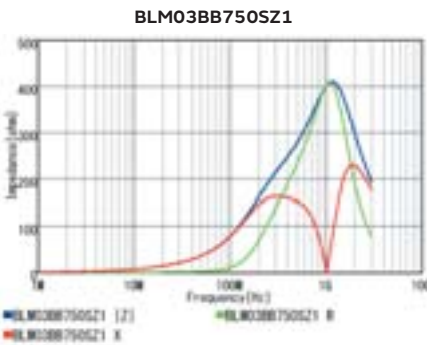
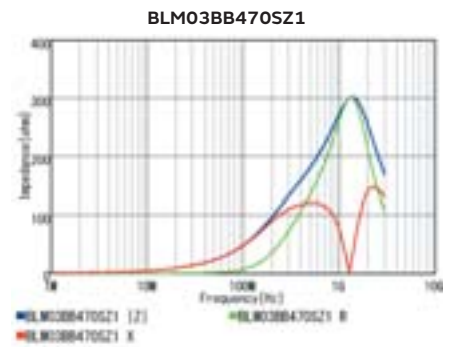
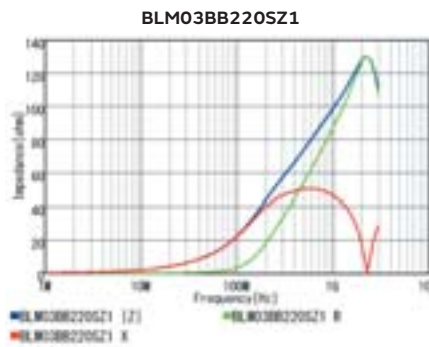
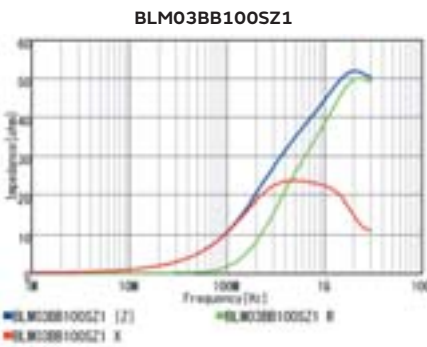
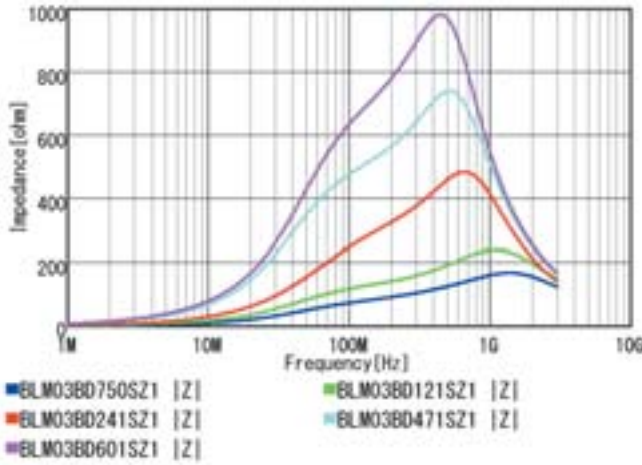

Continued on the following page. ↗

SMD Type  
 Chip Ferrite Bead  
 SMD Type  
 Chip EMIFIL®  
 SMD Type  
 Chip Common Mode Choke Coil  
 SMD Type  
 Block Type EMIFIL®  
 Lead Type  
 EMI Suppression Filters  
 SMD Type  
 Microchip Transformer (Balun)

Continued from the preceding page. ↘

**Z-f characteristics**

**BLM03BD121SZ1**

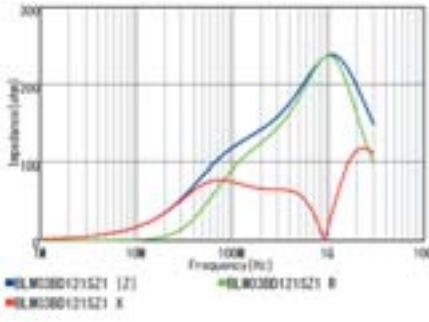

**BLM03BD241SZ1**

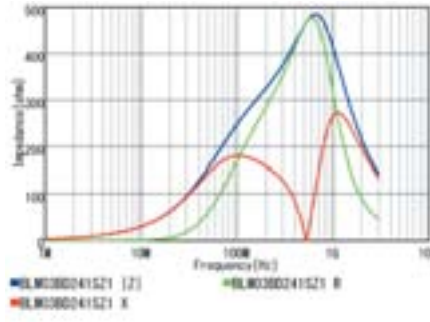

**BLM03BD471SZ1**

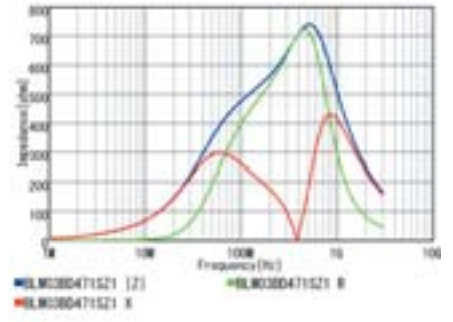

**BLM03BD601SZ1**

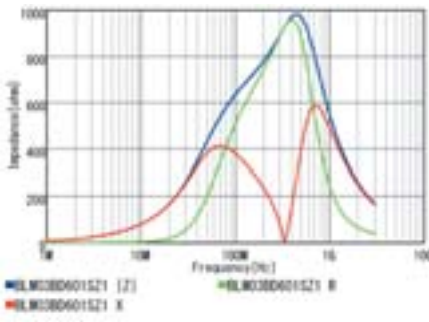

Chip Ferrite Bead  
 SMD Type

Chip EMIFIL®  
 SMD Type

Chip Common Mode Choke Coil  
 SMD Type

Block Type EMIFIL®  
 SMD Type

EMI Suppression Filters  
 Lead Type

Microchip Transformer (Balun)  
 SMD Type



# Chip Ferrite Bead SMD Type

## BLM03HB/HD/HG Series 0201/0603(inch/mm)

### Appearance/Dimensions

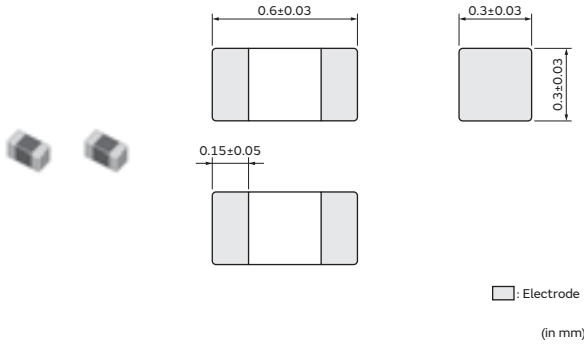

### Packaging

Code	Packaging	Minimum Quantity
D	ø180mm Paper Tape	15000
J	ø330mm Paper Tape	50000
B	Bulk(Bag)	1000

### Equivalent Circuit



(Resistance element becomes dominant at high frequencies.)

### Rated Value (□: packaging code)

Part Number		Impedance at 100MHz	Impedance at 1GHz	Rated Current at 85°C	Rated Current at 125°C	DC Resistance (Max.)
Infotainment	Powertrain/Safety					
BLM03HB191SZ1□	—	190Ω±25%	1150Ω±40%	150mA	150mA	2Ω
BLM03HB401SZ1□	—	400Ω±25%	1850Ω±40%	125mA	125mA	2.8Ω
BLM03HD331SZ1□	—	330Ω±25%	750Ω±40%	200mA	200mA	1Ω
BLM03HD471SZ1□	—	470Ω±25%	1000Ω±40%	175mA	175mA	1.3Ω
BLM03HD601SZ1□	—	600Ω±25%	1500Ω±40%	150mA	150mA	1.7Ω
BLM03HD102FZ1□	—	1000Ω±25%	2300Ω±40%	135mA	135mA	2.4Ω
BLM03HD102SZ1□	—	1000Ω±25%	2300Ω±40%	120mA	120mA	2.9Ω
BLM03HD152FZ1□	—	1500Ω±25%	2700Ω±40%	120mA	120mA	3.1Ω
BLM03HD182FZ1□	—	1800Ω±25%	3000Ω±40%	100mA	100mA	3.8Ω
BLM03HG601SZ1□	BLM03HG601SH1□	600Ω±25%	1000Ω±40%	150mA	150mA	1.6Ω
BLM03HG102SZ1□	BLM03HG102SH1□	1000Ω±25%	1800Ω±40%	125mA	125mA	2.6Ω
BLM03HG122SZ1□	BLM03HG122SH1□	1200Ω±25%	2000Ω±40%	100mA	100mA	3.5Ω

Operating Temp. Range: -55°C to 125°C

### Z-f characteristics: BLM03HB\_SZ1 series

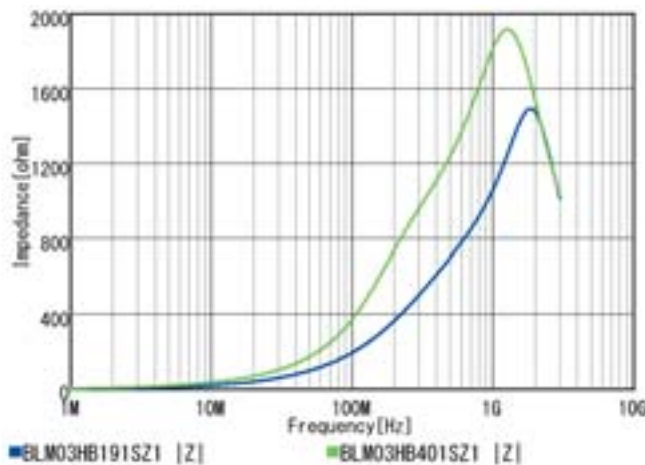

### Z-f characteristics: BLM03HD\_SZ1 series

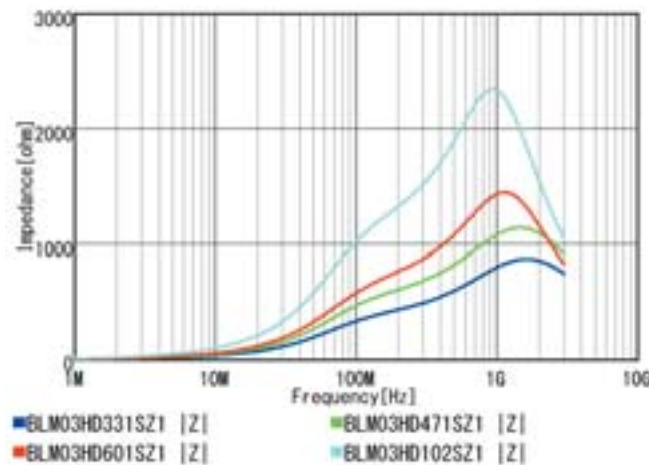

Continued on the following page. ↗

Continued from the preceding page. ↘

**Z-f characteristics: BLM03HD\_FZ1 series**

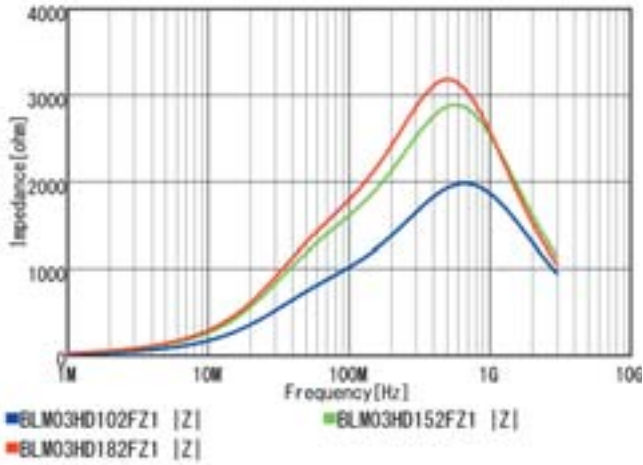

**Z-f characteristics: BLM03HG\_SZ1 series**

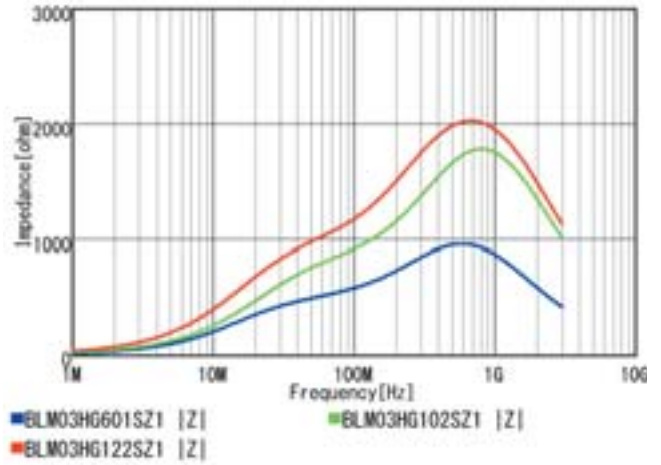

**Z-f characteristics: BLM03HG\_SH1 series**

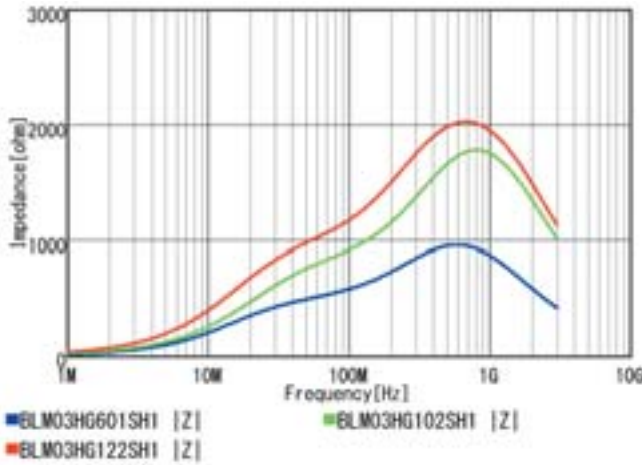

**BLM03HB191SZ1**

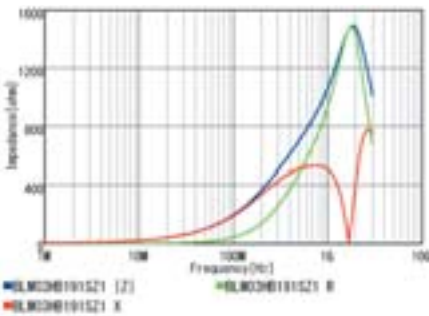

**BLM03HB401SZ1**

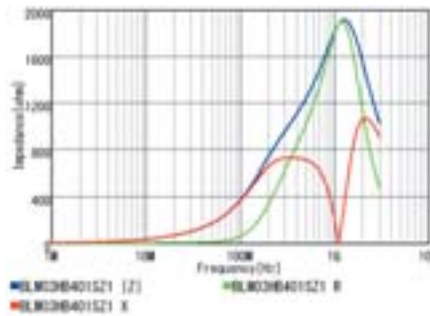

**BLM03HD331SZ1**

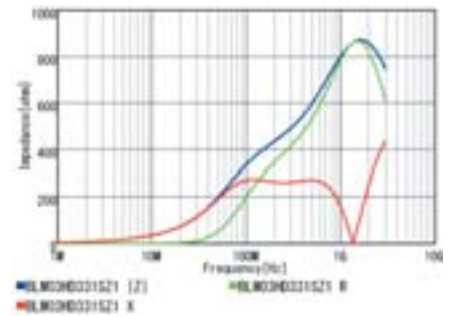

**BLM03HD471SZ1**

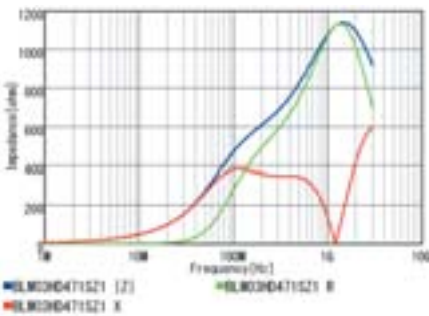

**BLM03HD601SZ1**

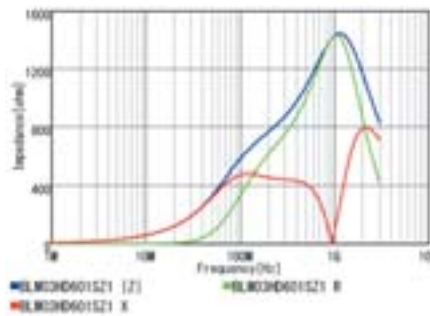

**BLM03HD102FZ1**

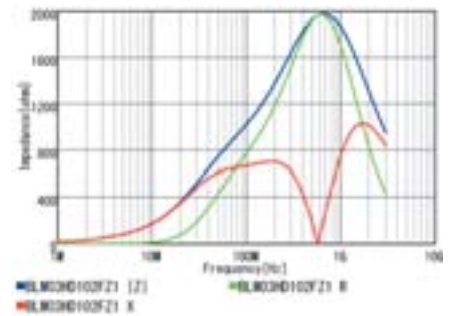

Continued on the following page. ↗

Chip Ferrite Bead SMD Type  
 Chip Common Mode Choke Coil SMD Type  
 Block Type EMIFIL® SMD Type  
 EMI Suppression Filters Lead Type  
 Microchip Transformer (Balun) SMD Type

Continued from the preceding page. ↘

### Z-f characteristics

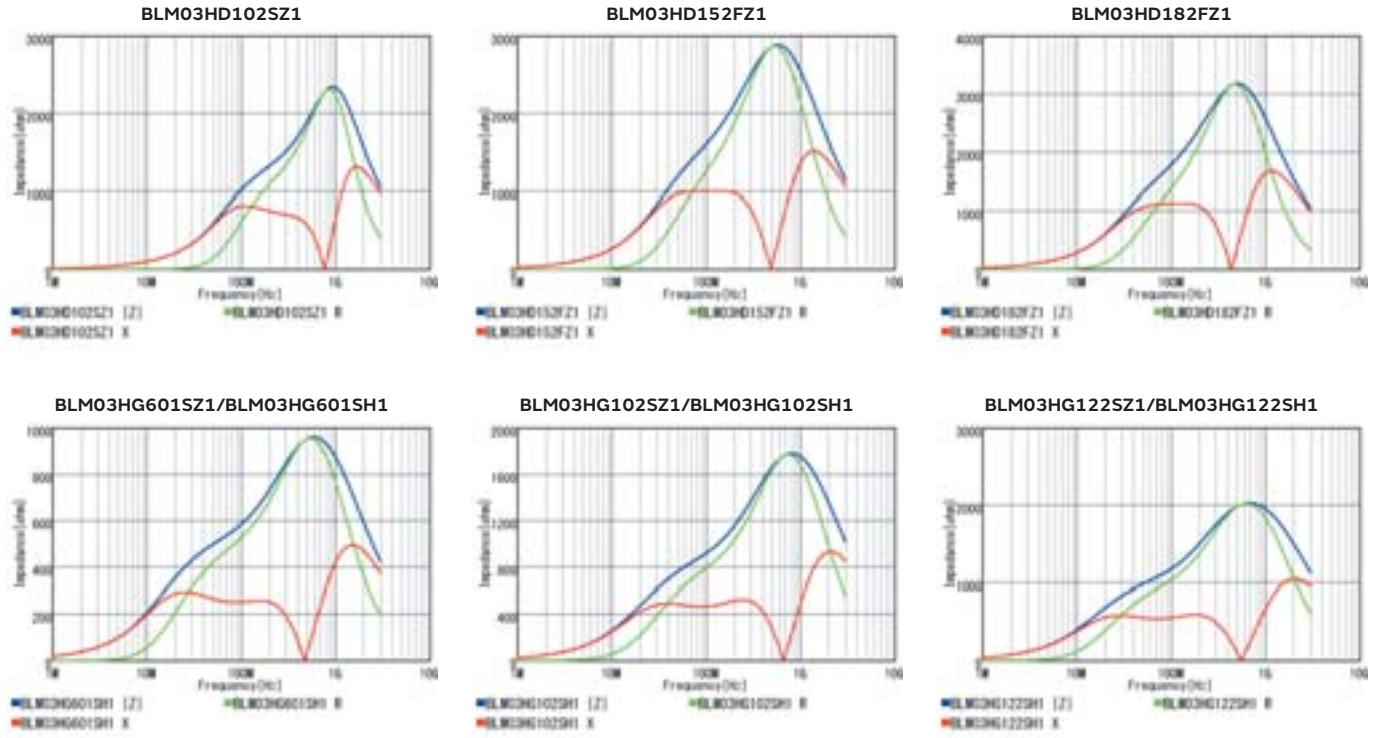

SMD Type  
 Chip Ferrite Bead

SMD Type  
 Chip EMIFIL®

SMD Type  
 Chip Common Mode Choke Coil

SMD Type  
 Block Type EMIFIL®

Lead Type  
 EMI Suppression Filters

SMD Type  
 Microchip Transformer (Balun)

# Chip Ferrite Bead SMD Type

## BLM03EB Series 0201/0603(inch/mm)

### Appearance/Dimensions

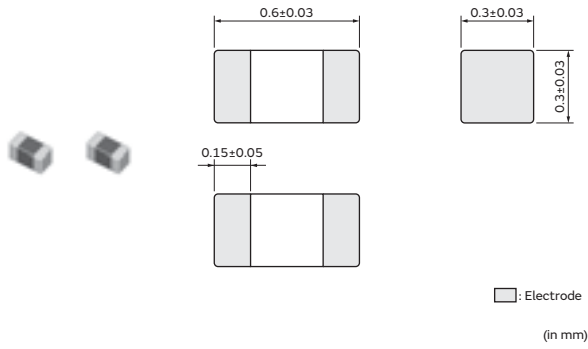

### Packaging

Code	Packaging	Minimum Quantity
D	ø180mm Paper Tape	15000
J	ø330mm Paper Tape	50000
B	Bulk(Bag)	1000

### Equivalent Circuit



(Resistance element becomes dominant at high frequencies.)

### Rated Value (□: packaging code)

Part Number		Impedance at 100MHz	Impedance at 1GHz	Rated Current at 85°C	Rated Current at 125°C	DC Resistance (Max.)
Infotainment	Powertrain/Safety					
BLM03EB250SZ1□	—	25Ω±25%	105Ω±40%	600mA	450mA	0.26Ω
BLM03EB500SZ1□	—	50Ω±25%	255Ω±40%	400mA	300mA	0.58Ω

Operating Temp. Range: -55°C to 125°C

### Z-f characteristics: BLM03EB\_SZ1 series

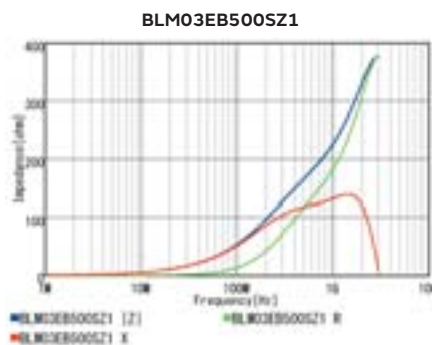
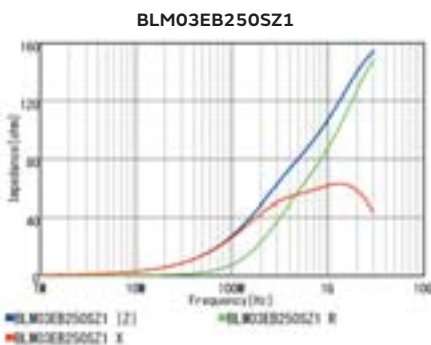
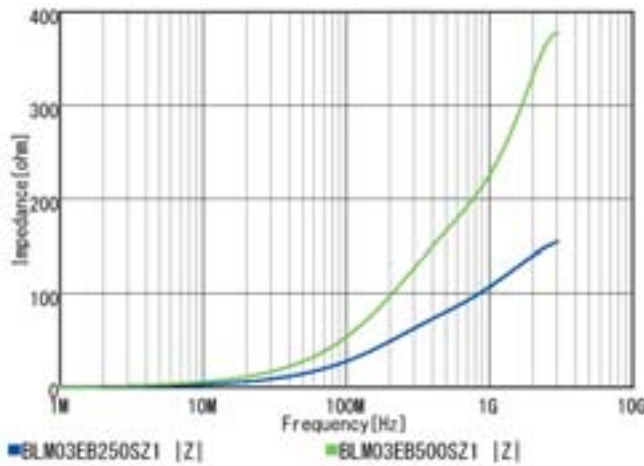

Continued on the following page. ↗

Continued from the preceding page. ↘

## Derating of Rated Current

In operating temperature exceeding +85°C, derating of current is necessary for BLM03E series.  
Please apply the derating curve shown in chart according to the operating temperature.

Derating of Rated Current

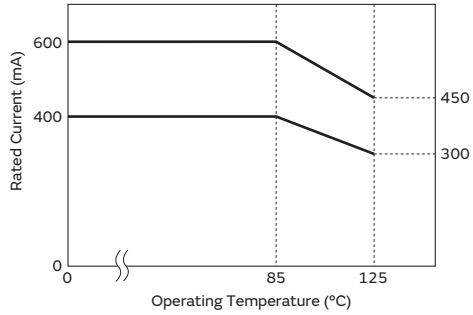

# Chip Ferrite Bead SMD Type

## BLM15PX Series 0402/1005(inch/mm)

### Appearance/Dimensions

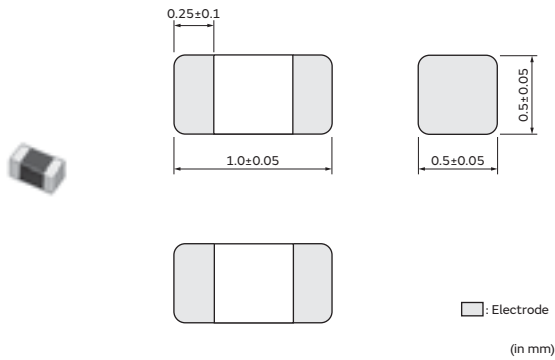

### Packaging

Code	Packaging	Minimum Quantity
D	ø180mm Paper Tape	10000
J	ø330mm Paper Tape	50000
B	Bulk(Bag)	1000

### Equivalent Circuit

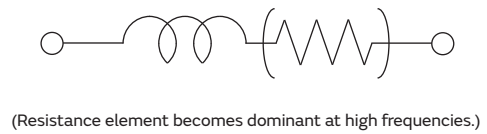

### Rated Value (□: packaging code)

Part Number		Impedance at 100MHz	Rated Current at 85°C	Rated Current at 125°C	DC Resistance (Max.)
Infotainment	Powertrain/Safety				
BLM15PX330SZ1□	—	33Ω±25%	3A	1.7A	0.022Ω
BLM15PX600SZ1□	—	60Ω±25%	2.5A	1.4A	0.032Ω
BLM15PX800SZ1□	—	80Ω±25%	2.3A	1.3A	0.038Ω
BLM15PX121SZ1□	—	120Ω±25%	2A	1.1A	0.055Ω
BLM15PX181SZ1□	—	180Ω±25%	1.5A	800mA	0.09Ω
BLM15PX221SZ1□	—	220Ω±25%	1.4A	800mA	0.1Ω
BLM15PX331SZ1□	—	330Ω±25%	1.2A	700mA	0.15Ω
BLM15PX471SZ1□	—	470Ω±25%	1A	600mA	0.2Ω
BLM15PX601SZ1□	—	600Ω±25%	900mA	500mA	0.23Ω

Operating Temp. Range: -55°C to 125°C

### Z-f characteristics: BLM15PX\_SZ1 series

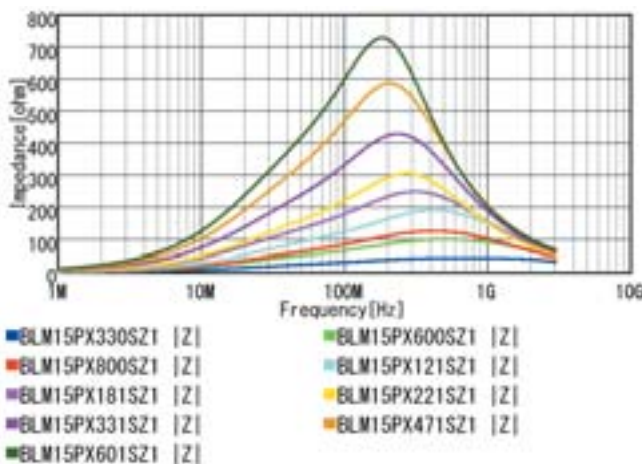

Continued on the following page. ↗

Continued from the preceding page. ↘

## Z-f characteristics

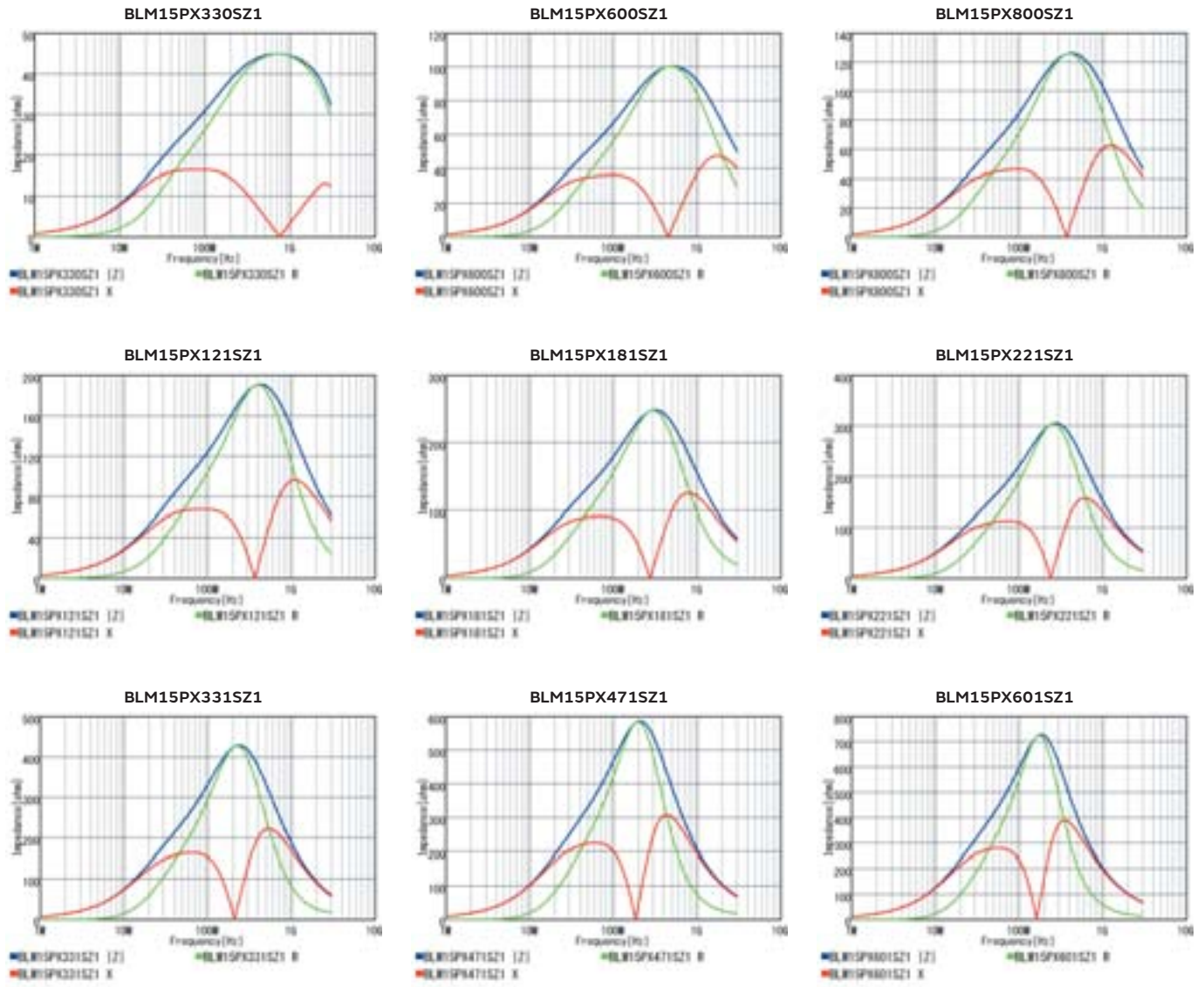

## Derating of Rated Current

In operating temperature exceeding +85°C, derating of current is necessary for BLM15PX series. Please apply the derating curve shown in chart according to the operating temperature.

Derating of Rated Current

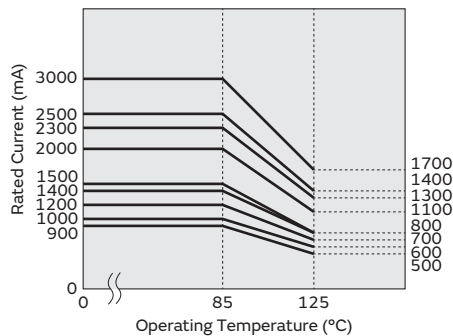

SMD Type  
 Chip Ferrite Bead

SMD Type  
 Chip EMIFIL®

SMD Type  
 Chip Common Mode Choke Coil

SMD Type  
 Block Type EMIFIL®

Lead Type  
 EMI Suppression Filters

SMD Type  
 Microchip Transformer (Balun)

# Chip Ferrite Bead SMD Type

## BLM15PG/PD Series 0402/1005(inch/mm)

### Appearance/Dimensions

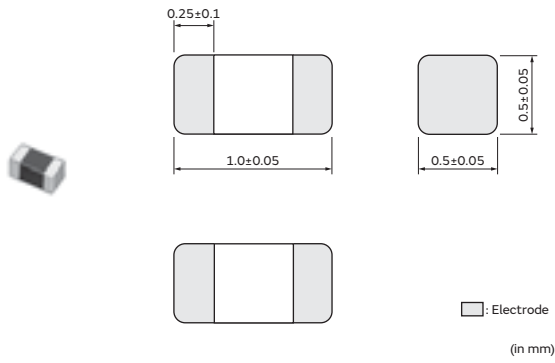

### Packaging

Code	Packaging	Minimum Quantity
D	ø180mm Paper Tape	10000
J	ø330mm Paper Tape	50000
B	Bulk(Bag)	1000

### Equivalent Circuit

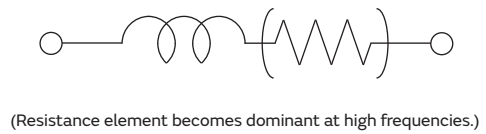

### Rated Value (□: packaging code)

Part Number		Impedance at 100MHz	Rated Current at 85°C	Rated Current at 125°C	DC Resistance (Max.)
Infotainment	Powertrain/Safety				
BLM15PG100SZ1□	—	10Ω(Typ.)	1A	1A	0.025Ω
BLM15PD300SZ1□	—	30Ω±25%	2.2A	1.4A	0.035Ω
BLM15PD600SZ1□	—	60Ω±25%	1.7A	1.1A	0.06Ω
BLM15PD800SZ1□	—	80Ω±25%	1.5A	1A	0.07Ω
BLM15PD121SZ1□	—	120Ω±25%	1.3A	900mA	0.09Ω

Operating Temp. Range: -55°C to 125°C

### Z-f characteristics: BLM15PG/PD\_SZ1 series

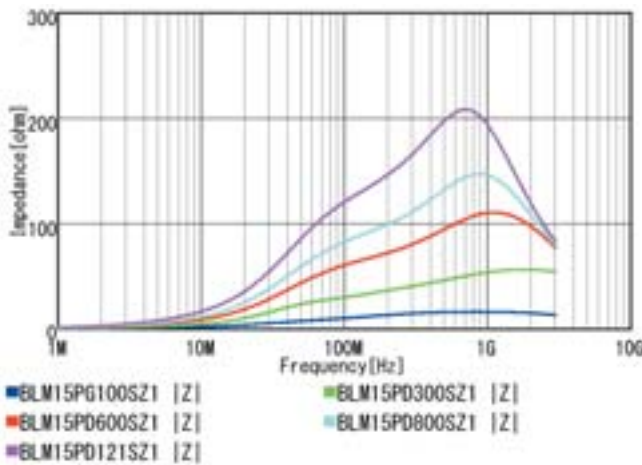

Continued on the following page. ↗



Continued from the preceding page. ↘

### Z-f characteristics

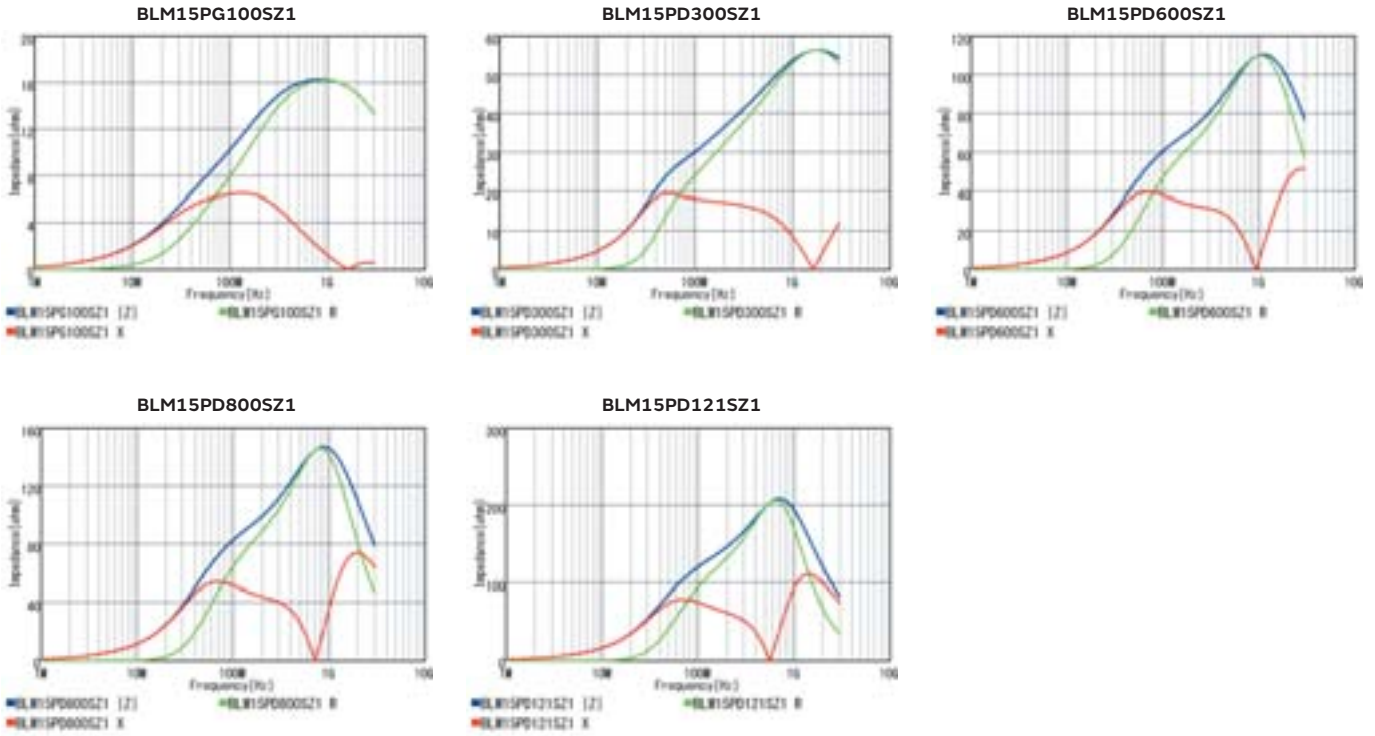

### Derating of Rated Current

In operating temperature exceeding +85°C, derating of current is necessary for BLM15PD series. Please apply the derating curve shown in chart according to the operating temperature.

Derating of Rated Current

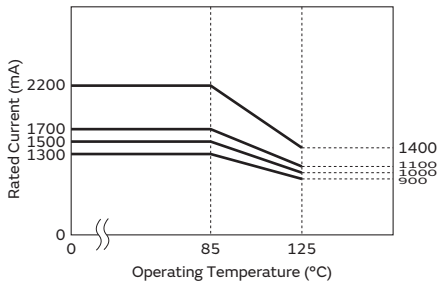

# Chip Ferrite Bead SMD Type

## BLM15AX Series 0402/1005(inch/mm)

### Appearance/Dimensions

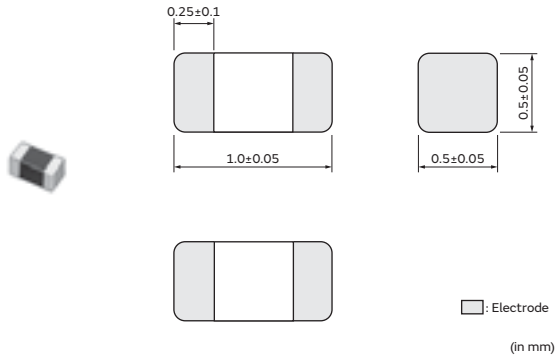

### Packaging

Code	Packaging	Minimum Quantity
D	ø180mm Paper Tape	10000
J	ø330mm Paper Tape	50000
B	Bulk(Bag)	1000

### Equivalent Circuit

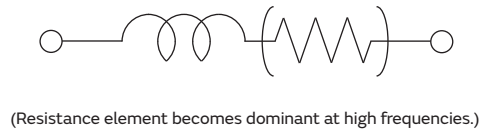

### Rated Value (□: packaging code)

Part Number		Impedance at 100MHz	Rated Current at 85°C	Rated Current at 125°C	DC Resistance (Max.)
Infotainment	Powertrain/Safety				
BLM15AX100SZ1□	—	10Ω±5Ω	1.74A	1.74A	0.015Ω
BLM15AX300SZ1□	—	30Ω±25%	1.1A	1.1A	0.06Ω
BLM15AX700SZ1□	—	70Ω±25%	780mA	780mA	0.1Ω
BLM15AX121SZ1□	—	120Ω±25%	700mA	700mA	0.13Ω
BLM15AX221SZ1□	—	220Ω±25%	600mA	600mA	0.18Ω
BLM15AX601SZ1□	—	600Ω±25%	500mA	500mA	0.34Ω
BLM15AX102SZ1□	—	1000Ω±25%	350mA	350mA	0.49Ω

Operating Temp. Range: -55°C to 125°C

### Z-f characteristics: BLM15AX\_SZ1 series

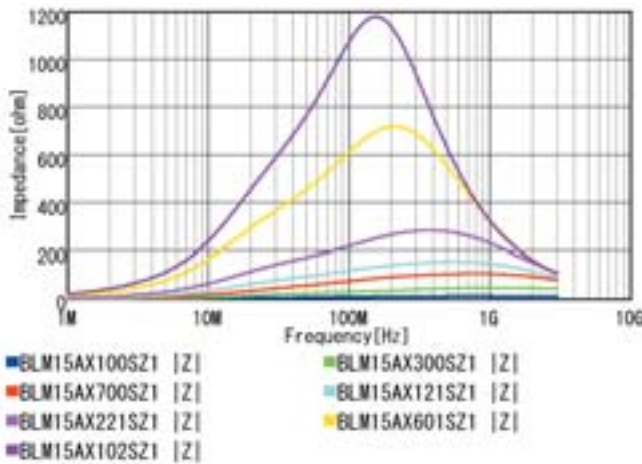

Continued on the following page. ↗

Continued from the preceding page. ↘

### Z-f characteristics

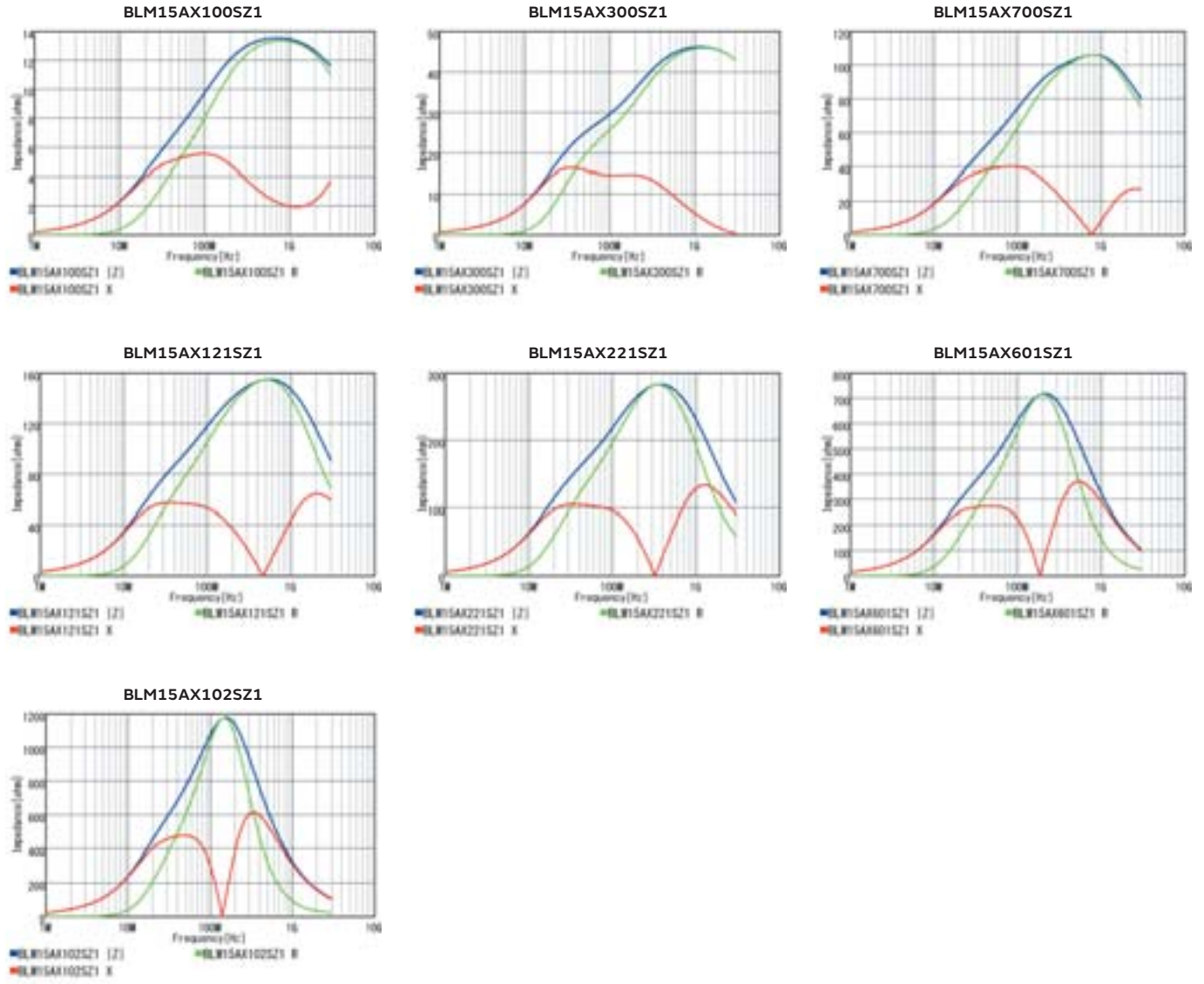

SMD Type  
 Chip Ferrite Bead

SMD Type  
 Chip EMIFIL®

SMD Type  
 Chip Common Mode Choke Coil

SMD Type  
 Block Type EMIFIL®

Lead Type  
 EMI Suppression Filters

SMD Type  
 Microchip Transformer (Balun)

# Chip Ferrite Bead SMD Type

## BLM15AG Series 0402/1005(inch/mm)

### Appearance/Dimensions

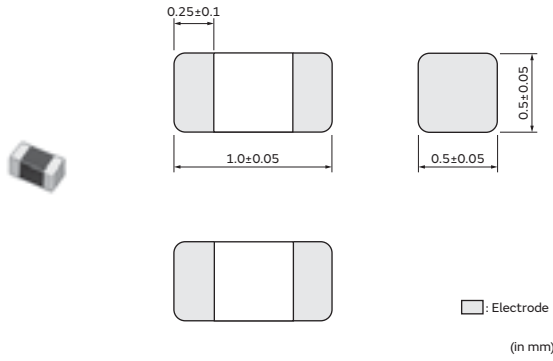

### Packaging

Code	Packaging	Minimum Quantity
D	ø180mm Paper Tape	10000
J	ø330mm Paper Tape	50000
B	Bulk(Bag)	1000

### Equivalent Circuit



(Resistance element becomes dominant at high frequencies.)

### Rated Value (□: packaging code)

Part Number		Impedance at 100MHz	Rated Current at 85°C	Rated Current at 125°C	DC Resistance (Max.)
Infotainment	Powertrain/Safety				
BLM15AG100SZ1□	BLM15AG100SH1□	10Ω(Typ.)	1A	1A	0.025Ω/0.05Ω
BLM15AG700SZ1□	BLM15AG700SH1□	70Ω(Typ.)	600mA/500mA	600mA/500mA	0.15Ω
BLM15AG121SZ1□	BLM15AG121SH1□	120Ω±25%	550mA/500mA	550mA/500mA	0.19Ω/0.25Ω
BLM15AG221SZ1□	BLM15AG221SH1□	220Ω±25%	450mA/300mA	450mA/300mA	0.29Ω/0.35Ω
BLM15AG601SZ1□	BLM15AG601SH1□	600Ω±25%	300mA	300mA	0.52Ω/0.6Ω
BLM15AG102SZ1□	BLM15AG102SH1□	1000Ω±25%	300mA/200mA	300mA/200mA	0.65Ω/1Ω

Operating Temp. Range: -55°C to 125°C

### Z-f characteristics: BLM15AG\_SZ1 series

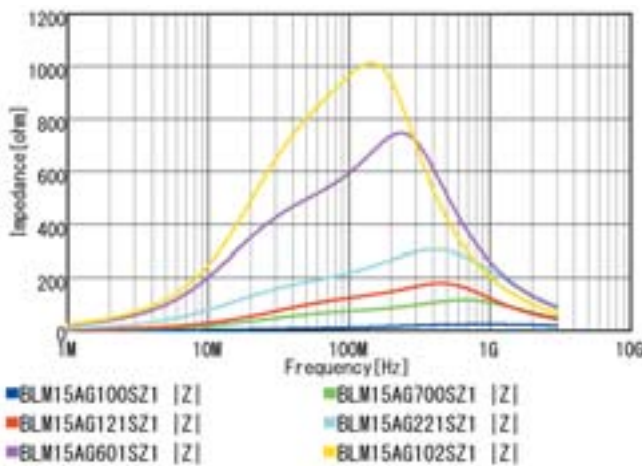

### Z-f characteristics: BLM15AG\_SH1 series

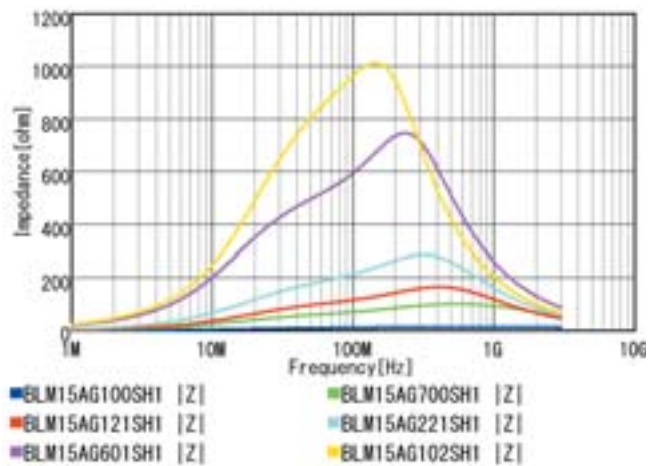

Continued on the following page. ↗

Continued from the preceding page. ↘

### Z-f characteristics

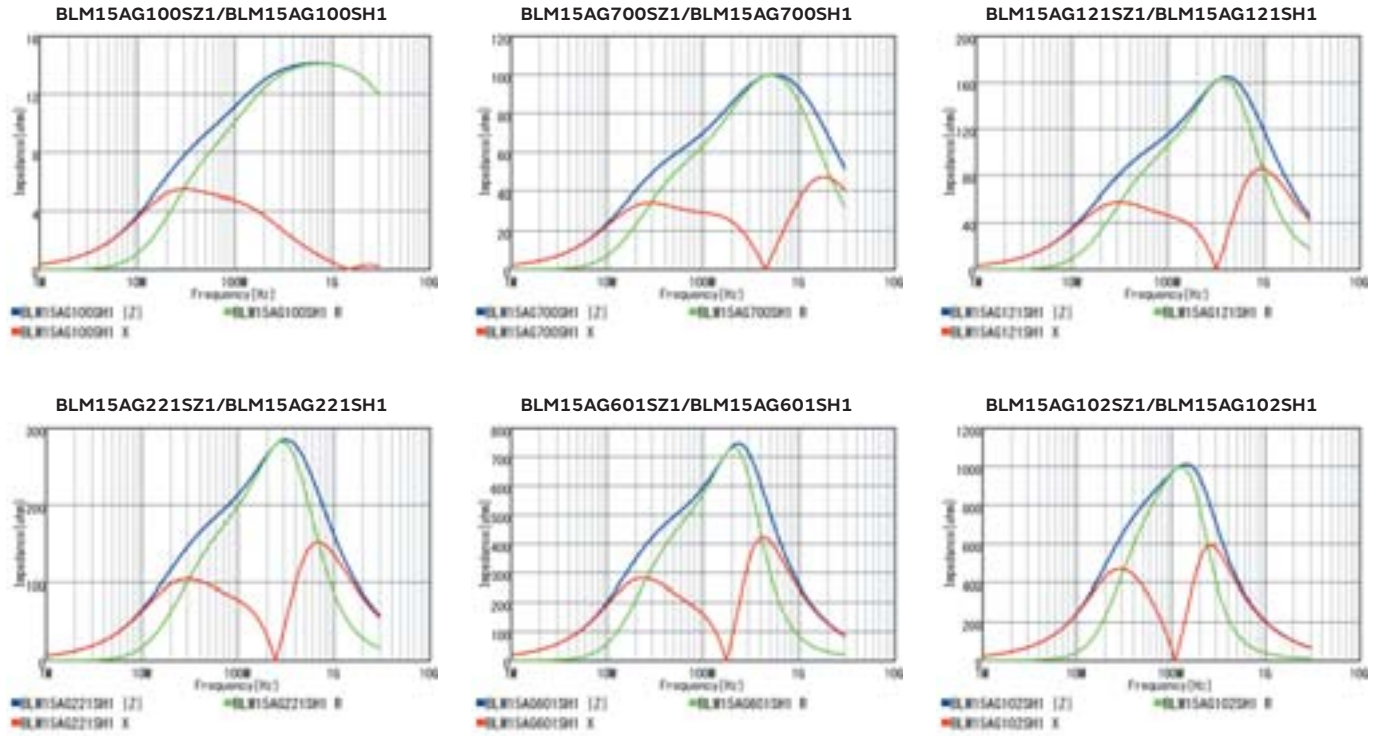

SMD Type  
 Chip Ferrite Bead

SMD Type  
 Chip EMIFIL®

SMD Type  
 Chip Common Mode Choke Coil

SMD Type  
 Block Type EMIFIL®

Lead Type  
 EMI Suppression Filters

SMD Type  
 Microchip Transformer (Balun)

# Chip Ferrite Bead SMD Type

## BLM15BX Series 0402/1005(inch/mm)

### Appearance/Dimensions

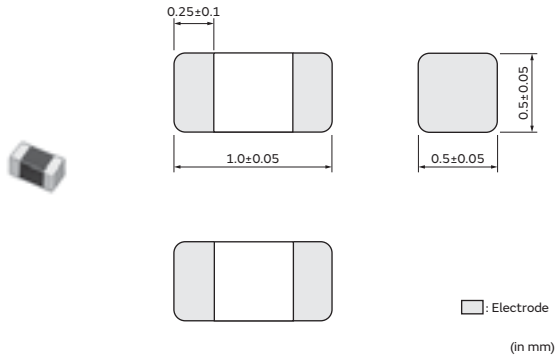

### Packaging

Code	Packaging	Minimum Quantity
D	ø180mm Paper Tape	10000
J	ø330mm Paper Tape	50000
B	Bulk(Bag)	1000

### Equivalent Circuit

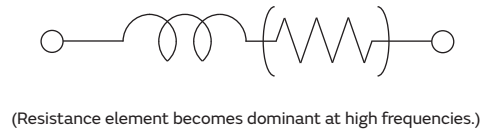

### Rated Value (□: packaging code)

Part Number		Impedance at 100MHz	Rated Current at 85°C	Rated Current at 125°C	DC Resistance (Max.)
Infotainment	Powertrain/Safety				
BLM15BX750SZ1□	—	75Ω±25%	600mA	600mA	0.15Ω
BLM15BX121SZ1□	—	120Ω±25%	600mA	600mA	0.17Ω
BLM15BX221SZ1□	—	220Ω±25%	450mA	450mA	0.27Ω
BLM15BX471SZ1□	—	470Ω±25%	350mA	350mA	0.41Ω
BLM15BX601SZ1□	—	600Ω±25%	350mA	350mA	0.46Ω
BLM15BX102SZ1□	—	1000Ω±25%	300mA	300mA	0.65Ω
BLM15BX182SZ1□	—	1800Ω±25%	250mA	250mA	0.9Ω

Operating Temp. Range: -55°C to 125°C

### Z-f characteristics: BLM15BX\_SZ1 series

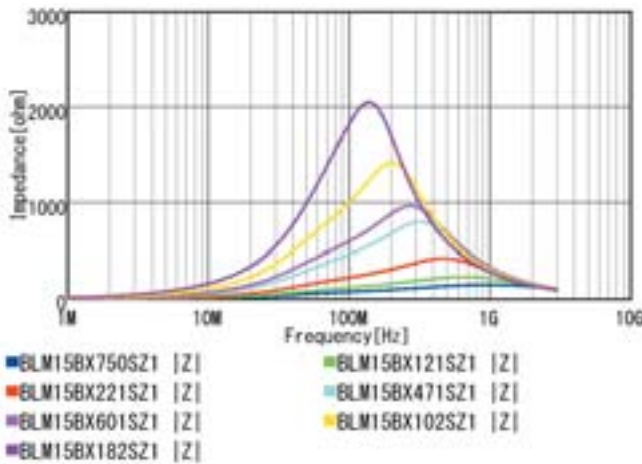

Continued on the following page. ↗

Continued from the preceding page. ↘

**Z-f characteristics**

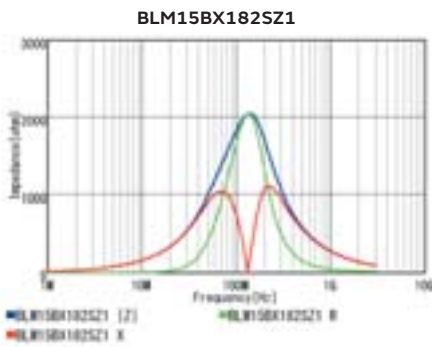
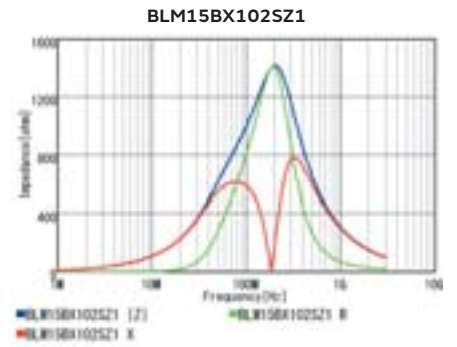
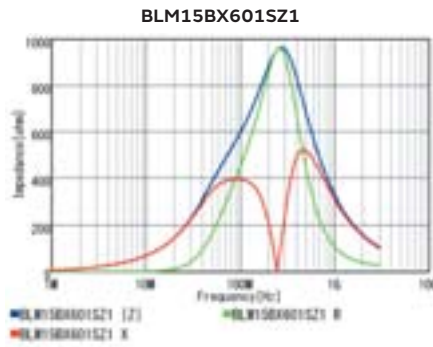
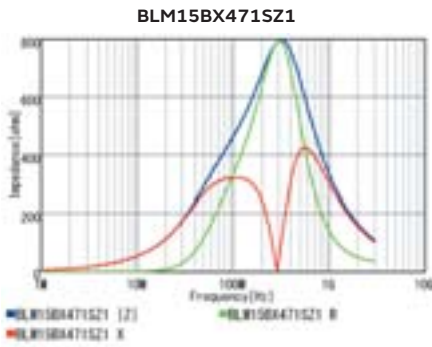
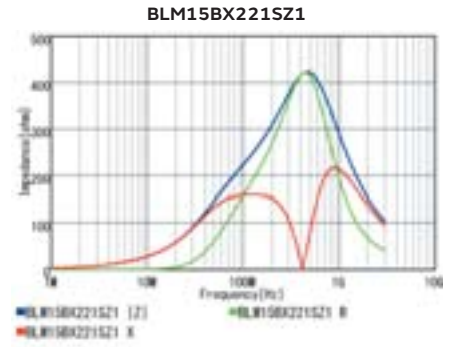
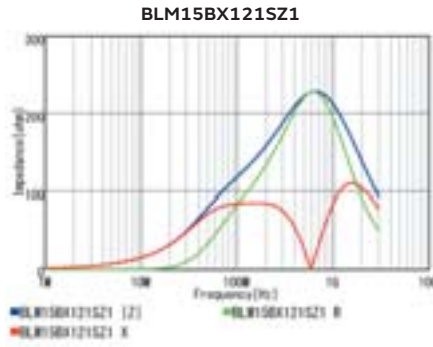
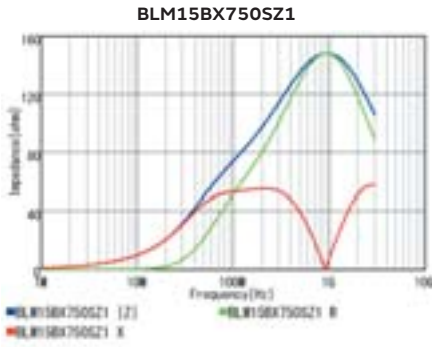

SMD Type  
 Chip Ferrite Bead

SMD Type  
 Chip EMIFIL®

SMD Type  
 Chip Common Mode Choke Coil

SMD Type  
 Block Type EMIFIL®

Lead Type  
 EMI Suppression Filters

SMD Type  
 Microchip Transformer (Balun)

# Chip Ferrite Bead SMD Type

## BLM15BA/BB/BC/BD Series 0402/1005(inch/mm)

### Appearance/Dimensions

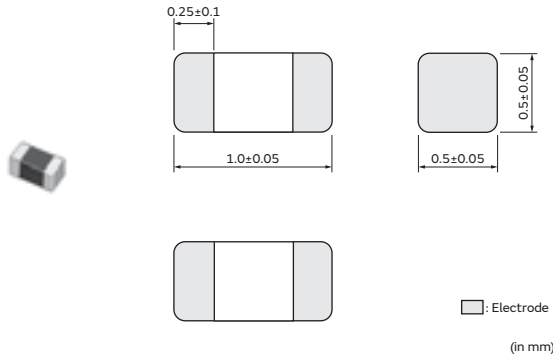

### Packaging

Code	Packaging	Minimum Quantity
D	ø180mm Paper Tape	10000
J	ø330mm Paper Tape	50000
B	Bulk(Bag)	1000

### Equivalent Circuit



(Resistance element becomes dominant at high frequencies.)

### Rated Value (□: packaging code)

Part Number		Impedance at 100MHz	Rated Current at 85°C	Rated Current at 125°C	DC Resistance (Max.)
Infotainment	Powertrain/Safety				
BLM15BA050SZ1□	—	5Ω±25%	300mA	300mA	0.1Ω
BLM15BA100SZ1□	—	10Ω±25%	300mA	300mA	0.2Ω
BLM15BA220SZ1□	—	22Ω±25%	300mA	300mA	0.3Ω
BLM15BA330SZ1□	—	33Ω±25%	300mA	300mA	0.4Ω
BLM15BA470SZ1□	—	47Ω±25%	200mA	200mA	0.6Ω
BLM15BA750SZ1□	—	75Ω±25%	200mA	200mA	0.8Ω
BLM15BB050SZ1□	BLM15BB050SH1□	5Ω±25%	500mA	500mA	0.08Ω
BLM15BB100SZ1□	BLM15BB100SH1□	10Ω±25%	300mA	300mA	0.1Ω
BLM15BB220SZ1□	BLM15BB220SH1□	22Ω±25%	300mA	300mA	0.2Ω
BLM15BB470SZ1□	BLM15BB470SH1□	47Ω±25%	300mA	300mA	0.35Ω
BLM15BB750SZ1□	BLM15BB750SH1□	75Ω±25%	300mA	300mA	0.4Ω
BLM15BB121SZ1□	BLM15BB121SH1□	120Ω±25%	300mA	300mA	0.55Ω
BLM15BB221SZ1□	BLM15BB221SH1□	220Ω±25%	200mA	200mA	0.8Ω
BLM15BC121SZ1□	—	120Ω±25%	350mA	350mA	0.45Ω
BLM15BC241SZ1□	—	240Ω±25%	250mA	250mA	0.7Ω
BLM15BD750SZ1□	—	75Ω±25%	300mA	300mA	0.2Ω
BLM15BD121SZ1□	—	120Ω±25%	300mA	300mA	0.3Ω
BLM15BD221SZ1□	—	220Ω±25%	300mA	300mA	0.4Ω
BLM15BD471SZ1□	BLM15BD471SH1□	470Ω±25%	200mA	200mA	0.6Ω
BLM15BD601SZ1□	BLM15BD601SH1□	600Ω±25%	200mA	200mA	0.65Ω
BLM15BD102SZ1□	BLM15BD102SH1□	1000Ω±25%	200mA	200mA	0.9Ω
BLM15BD152SZ1□	—	1500Ω±25%	190mA	190mA	1Ω
BLM15BD182SZ1□	BLM15BD182SH1□	1800Ω±25%	100mA/200mA	100mA/200mA	1.4Ω

Operating Temp. Range: -55°C to 125°C

Continued on the following page. ↗

Chip Ferrite Bead SMD Type  
 Chip EMIFIL® SMD Type  
 Chip Common Mode Choke Coil SMD Type  
 Block Type EMIFIL® SMD Type  
 EMI Suppression Filters Lead Type  
 Microchip Transformer (Balun) SMD Type



Continued from the preceding page. ↘

**Z-f characteristics: BLM15BA\_SZ1 series**

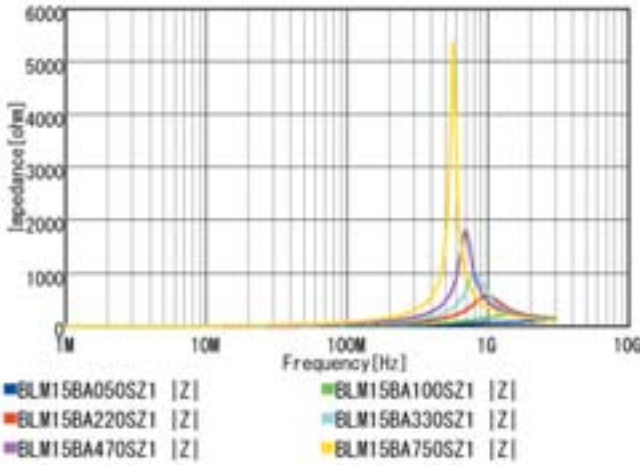

**Z-f characteristics: BLM15BB\_SZ1 series**

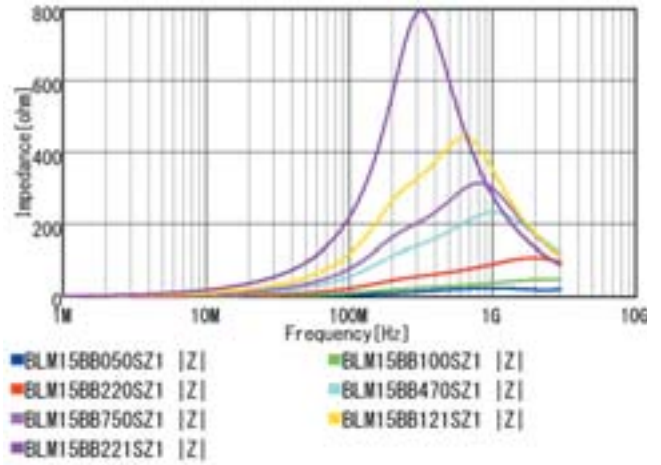

**Z-f characteristics: BLM15BB\_SH1 series**

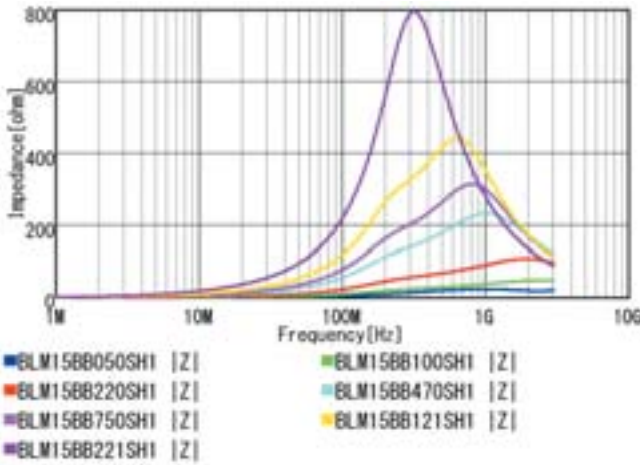

**Z-f characteristics: BLM15BC\_SZ1 series**

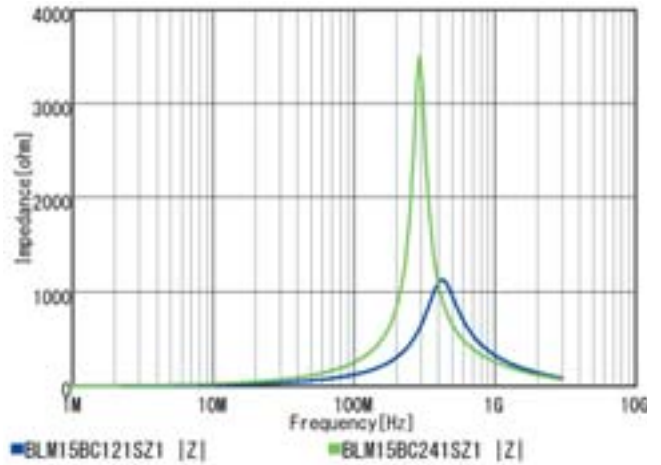

**Z-f characteristics: BLM15BD\_SZ1 series**

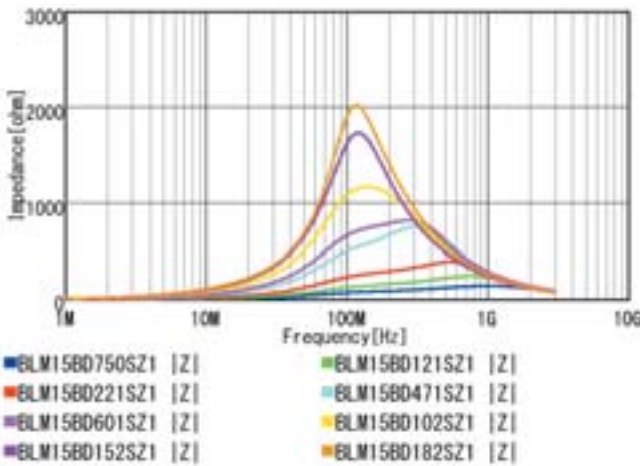

**Z-f characteristics: BLM15BD\_SH1 series**

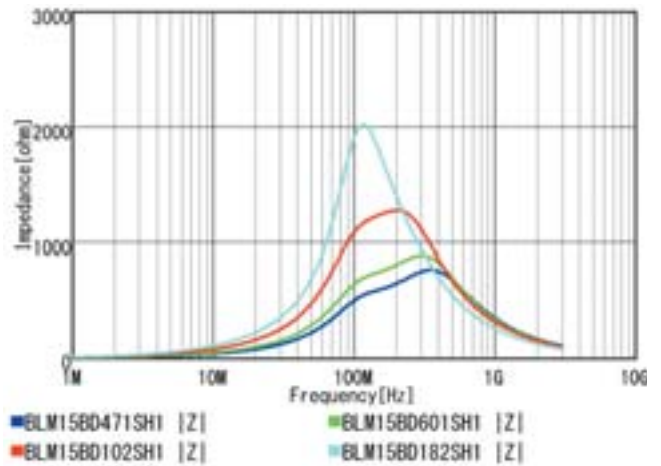

Continued on the following page. ↗

SMD Type  
 Chip Ferrite Bead  
 SMD Type  
 Chip EMIFIL®  
 SMD Type  
 Chip Common Mode Choke Coil  
 SMD Type  
 Block Type EMIFIL®  
 Lead Type  
 EMI Suppression Filters  
 SMD Type  
 Microchip Transformer (Balun)

Continued from the preceding page. ↘

**Z-f characteristics**

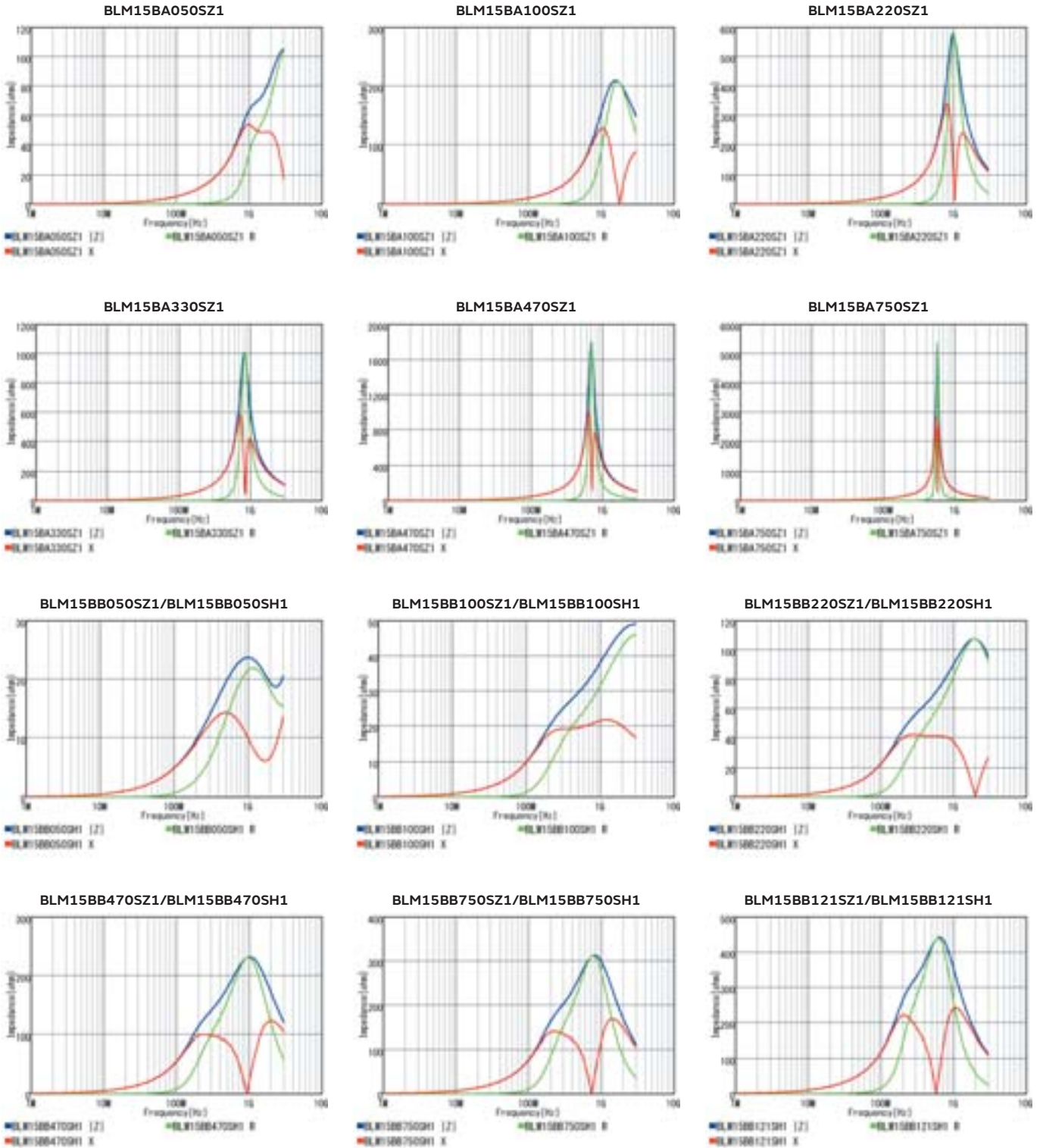

Continued on the following page. ↗

Chip Ferrite Bead SMD Type  
 Chip Common Mode Choke Coil SMD Type  
 Block Type EMIFIL® SMD Type  
 EMI Suppression Filters Lead Type  
 Microchip Transformer (Balun) SMD Type

Continued from the preceding page. ↘

### Z-f characteristics

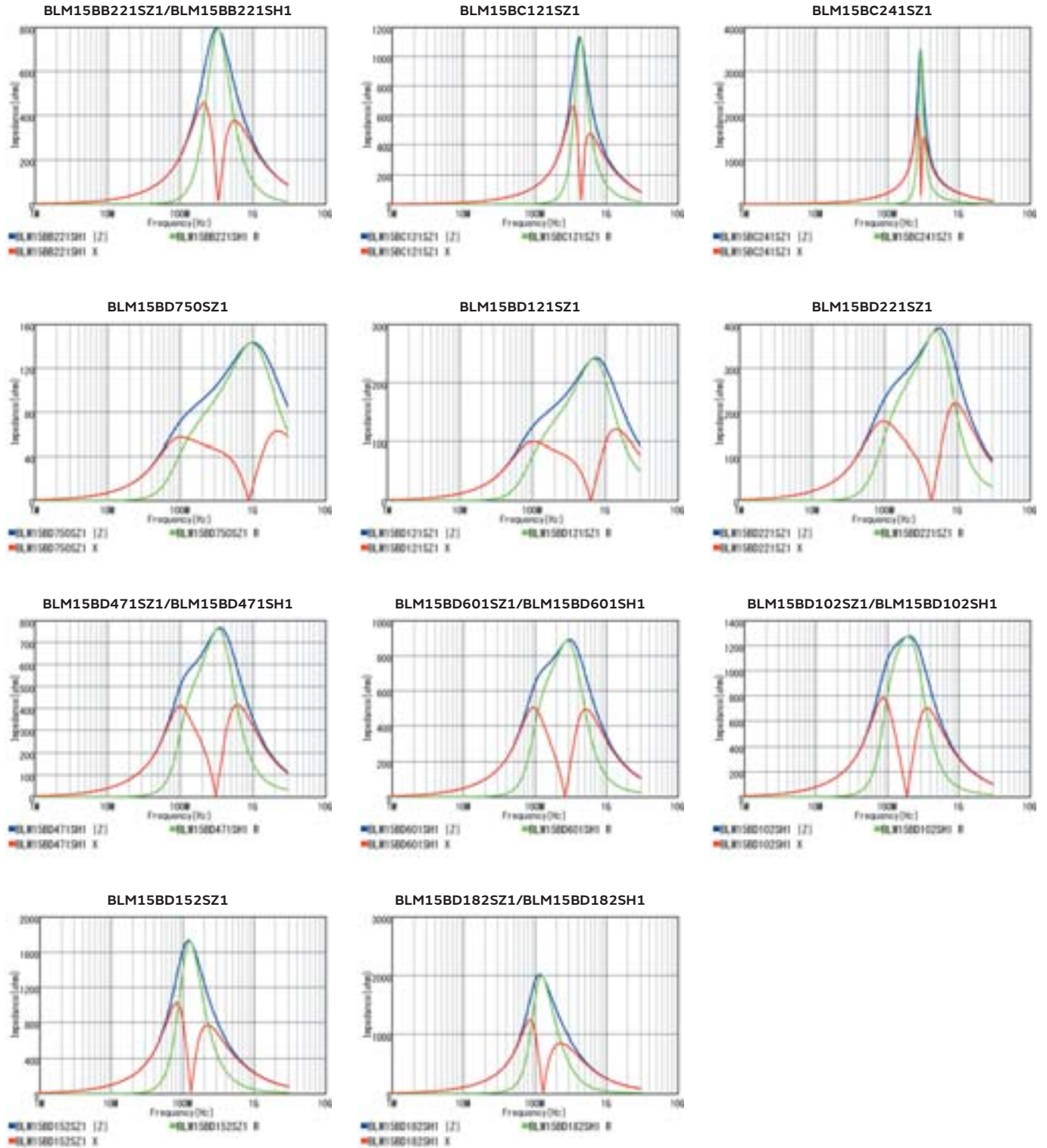

SMD Type  
 Chip Ferrite Bead

SMD Type  
 Chip EMI/FIL®

SMD Type  
 Chip Common Mode Choke Coil

SMD Type  
 Block Type EMI/FIL®

Lead Type  
 EMI Suppression Filters

SMD Type  
 Microchip Transformer (Balun)

# Chip Ferrite Bead SMD Type

## BLM15HB/HD/HG Series 0402/1005(inch/mm)

### Appearance/Dimensions

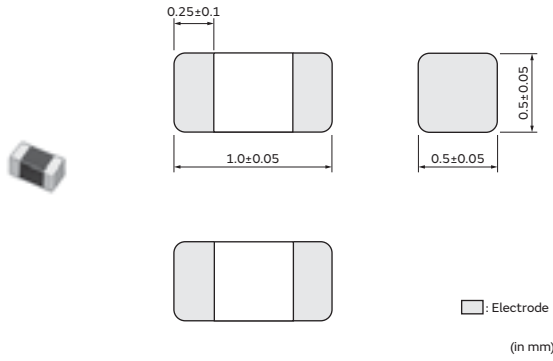

### Packaging

Code	Packaging	Minimum Quantity
D	ø180mm Paper Tape	10000
J	ø330mm Paper Tape	50000
B	Bulk(Bag)	1000

### Equivalent Circuit



(Resistance element becomes dominant at high frequencies.)

### Rated Value (□: packaging code)

Part Number		Impedance at 100MHz	Impedance at 1GHz	Rated Current at 85°C	Rated Current at 125°C	DC Resistance (Max.)
Infotainment	Powertrain/Safety					
BLM15HB121SZ1□	BLM15HB121SH1□	120Ω±25%	500Ω±40%	300mA	300mA	0.7Ω
BLM15HB221SZ1□	BLM15HB221SH1□	220Ω±25%	900Ω±40%	250mA	250mA	1Ω
BLM15HD601SZ1□	BLM15HD601SH1□	600Ω±25%	1400Ω±40%	300mA	300mA	0.85Ω
BLM15HD102SZ1□	BLM15HD102SH1□	1000Ω±25%	2000Ω±40%	250mA	250mA	1.25Ω
BLM15HD182SZ1□	BLM15HD182SH1□	1800Ω±25%	2700Ω±40%	200mA	200mA	2.2Ω
BLM15HG601SZ1□	BLM15HG601SH1□	600Ω±25%	1000Ω±40%	300mA	300mA	0.7Ω
BLM15HG102SZ1□	BLM15HG102SH1□	1000Ω±25%	1400Ω±40%	250mA	250mA	1.1Ω

Operating Temp. Range: -55°C to 125°C

### Z-f characteristics: BLM15HB\_SZ1 series

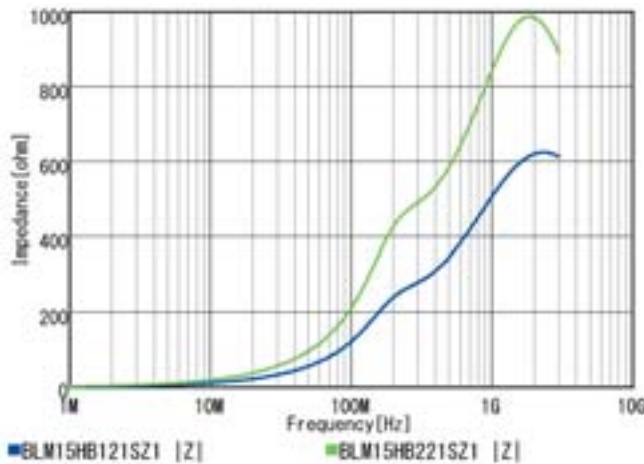

### Z-f characteristics: BLM15HB\_SH1 series

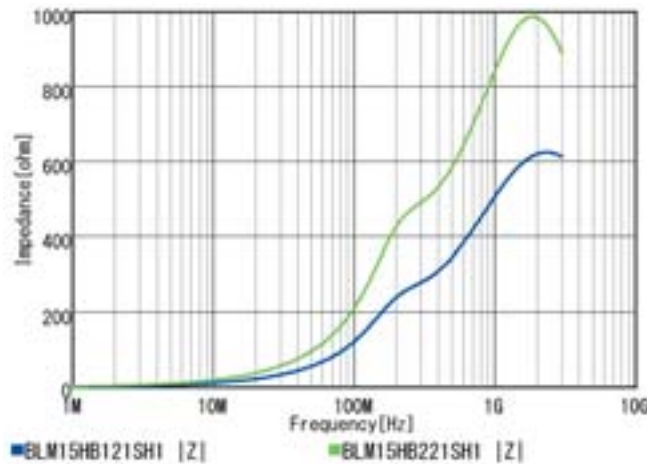

Continued on the following page. ↗

Chip Ferrite Bead SMD Type  
 Chip EMIFIL® SMD Type  
 Chip Common Mode Choke Coil SMD Type  
 Block Type EMIFIL® SMD Type  
 EMI Suppression Filters Lead Type  
 Microchip Transformer (Balun) SMD Type

Continued from the preceding page. ↘

**Z-f characteristics: BLM15HD\_SZ1 series**

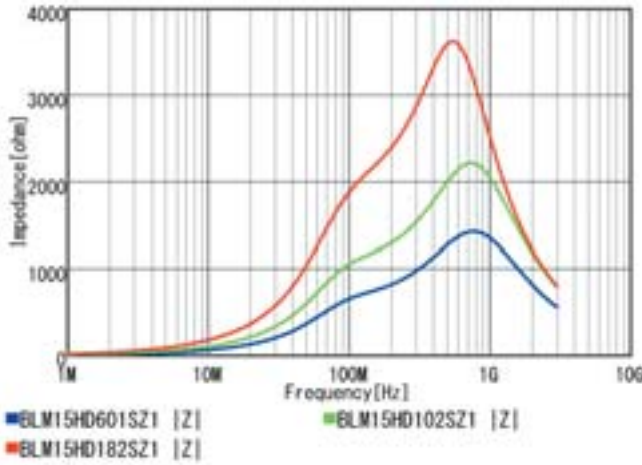

**Z-f characteristics: BLM15HD\_SH1 series**

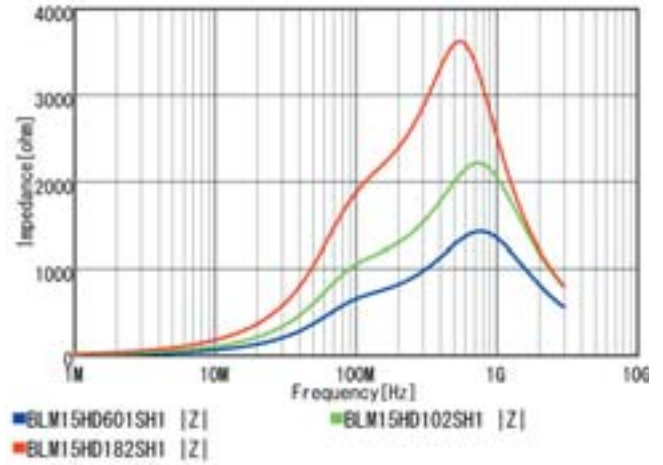

**Z-f characteristics: BLM15HG\_SZ1 series**

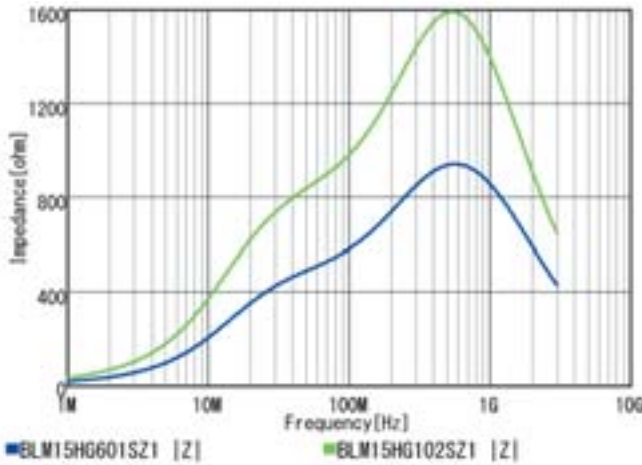

**Z-f characteristics: BLM15HG\_SH1 series**

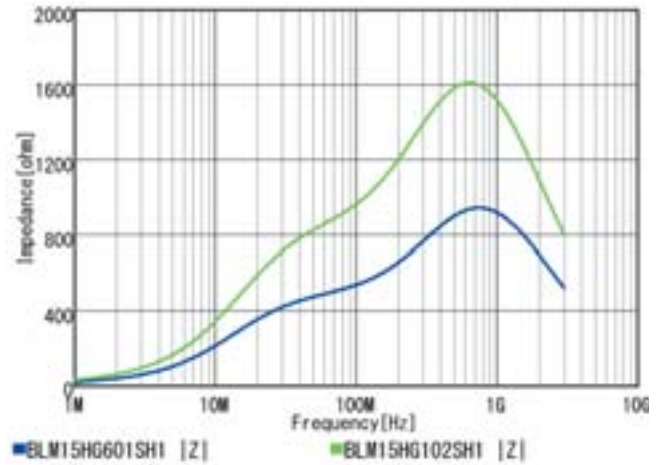

**BLM15HB121SZ1/BLM15HB121SH1**

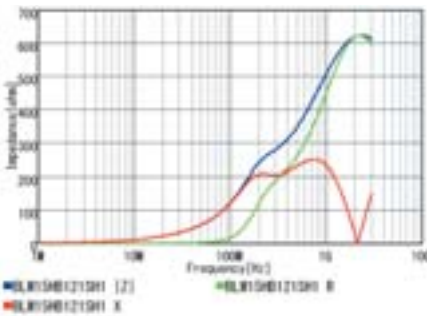

**BLM15HB221SZ1/BLM15HB221SH1**

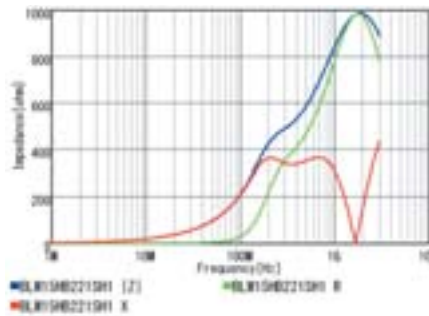

**BLM15HD601SZ1/BLM15HD601SH1**

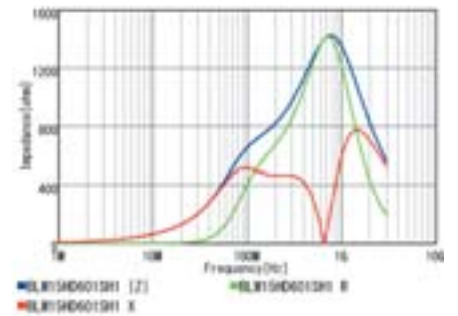

**BLM15HD102SZ1/BLM15HD102SH1**

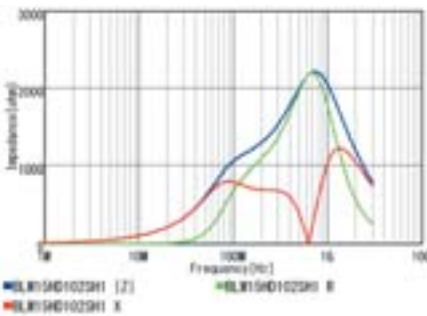

**BLM15HD182SZ1/BLM15HD182SH1**

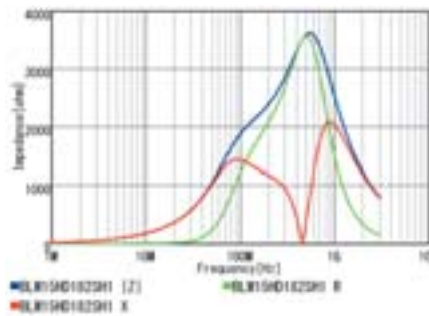

**BLM15HG601SZ1/BLM15HG601SH1**

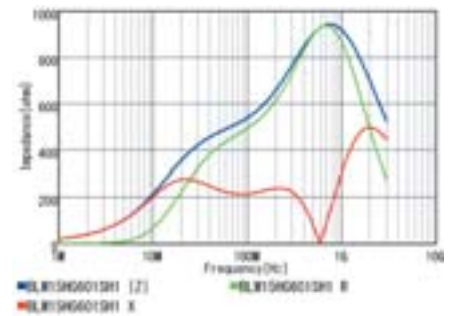

Continued on the following page. ↗

SMD Type  
 Chip Ferrite Bead  
 SMD Type  
 Chip EMIFIL®  
 SMD Type  
 Chip Common Mode Choke Coil  
 SMD Type  
 Block Type EMIFIL®  
 Lead Type  
 EMI Suppression Filters  
 SMD Type  
 Microchip Transformer (Balun)

Continued from the preceding page. ↘

## Z-f characteristics

BLM15HG102SZ1/BLM15HG102SH1

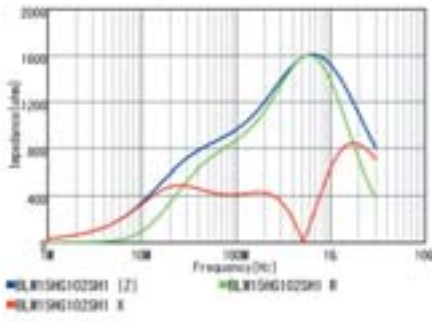

Chip Ferrite Bead  
SMD Type

Chip EMIFIL®  
SMD Type

Chip Common Mode Choke Coil  
SMD Type

Block Type EMIFIL®  
SMD Type

EMI Suppression Filters  
Lead Type

Microchip Transformer (Balun)  
SMD Type

# Chip Ferrite Bead SMD Type

## BLM15HG(150°C available) Series 0402/1005(inch/mm)

### Appearance/Dimensions

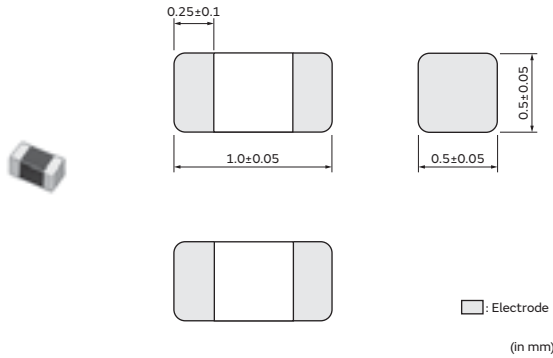

### Packaging

Code	Packaging	Minimum Quantity
D	ø180mm Paper Tape	10000
J	ø330mm Paper Tape	50000
B	Bulk(Bag)	1000

### Equivalent Circuit

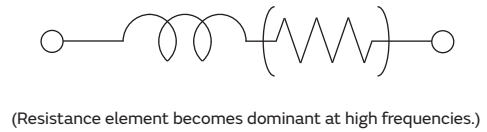

### Rated Value (□: packaging code)

Part Number		Impedance at 100MHz	Impedance at 1GHz	Rated Current at 85°C	Rated Current at 125°C	DC Resistance (Max.)
Infotainment	Powertrain/Safety					
—	BLM15HG601BH1□	600Ω±25%	1000Ω±40%	300mA	300mA	0.7Ω
—	BLM15HG102BH1□	1000Ω±25%	1400Ω±40%	250mA	250mA	1.1Ω

Rated Current at 150°C: 20mA  
 Operating Temp. Range: -55°C to 150°C

### Z-f characteristics: BLM15HG\_BH1 series

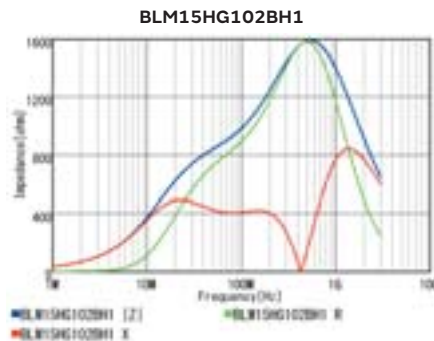
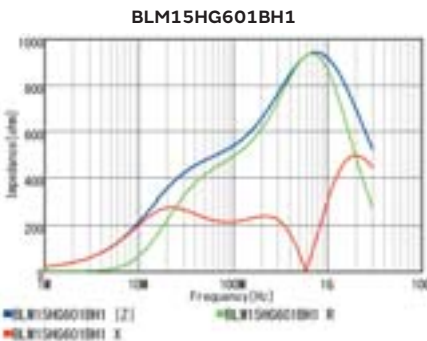
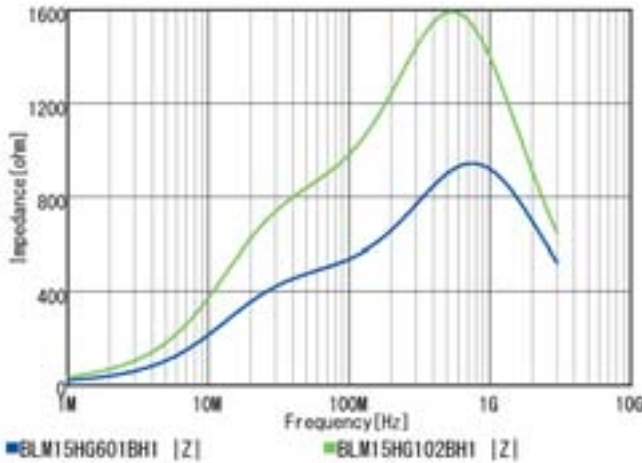

Continued on the following page. ↗

SMD Type  
 Chip Ferrite Bead

SMD Type  
 Chip EMIFIL®

SMD Type  
 Chip Common Mode Choke Coil

SMD Type  
 Block Type EMIFIL®

Lead Type  
 EMI Suppression Filters

SMD Type  
 Microchip Transformer (Balun)

Continued from the preceding page. ↘

## Derating of Rated Current

In operating temperature exceeding +125°C, derating of current is necessary for BLM15HG series.  
Please apply the derating curve shown in chart according to the operating temperature.

Derating of Rated Current

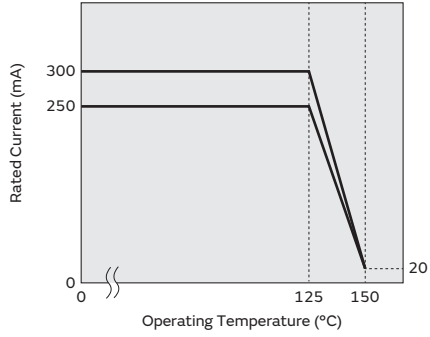

Chip Ferrite Bead  
SMD Type

Chip EMIFIL®  
SMD Type

Chip Common Mode Choke Coil  
SMD Type

Block Type EMIFIL®  
SMD Type

EMI Suppression Filters  
Lead Type

Microchip Transformer (Balun)  
SMD Type



# Chip Ferrite Bead SMD Type

## BLM15EG Series 0402/1005(inch/mm)

### Appearance/Dimensions

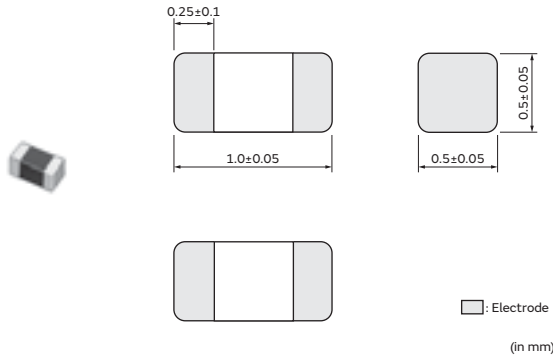

### Packaging

Code	Packaging	Minimum Quantity
D	ø180mm Paper Tape	10000
J	ø330mm Paper Tape	50000
B	Bulk(Bag)	1000

### Equivalent Circuit



(Resistance element becomes dominant at high frequencies.)

### Rated Value (□: packaging code)

Part Number		Impedance at 100MHz	Impedance at 1GHz	Rated Current at 85°C	Rated Current at 125°C	DC Resistance (Max.)
Infotainment	Powertrain/Safety					
BLM15EG121SZ1□	BLM15EG121SH1□	120Ω±25%	145Ω(Typ.)	1.5A	900mA	0.095Ω
BLM15EG221SZ1□	BLM15EG221SH1□	220Ω±25%	270Ω(Typ.)	700mA	500mA	0.28Ω

Operating Temp. Range: -55°C to 125°C

### Z-f characteristics: BLM15EG\_SZ1 series

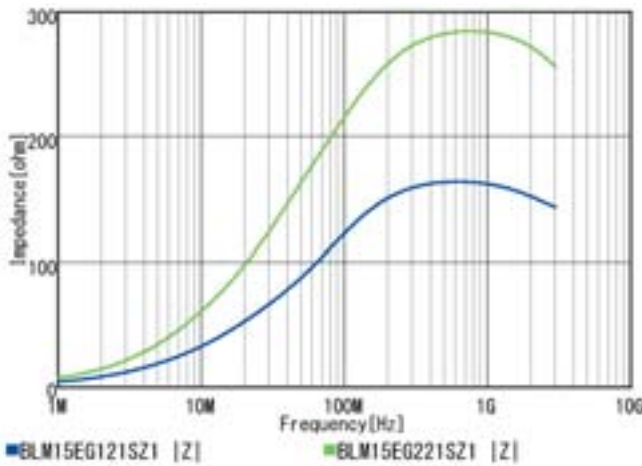

### Z-f characteristics: BLM15EG\_SH1 series

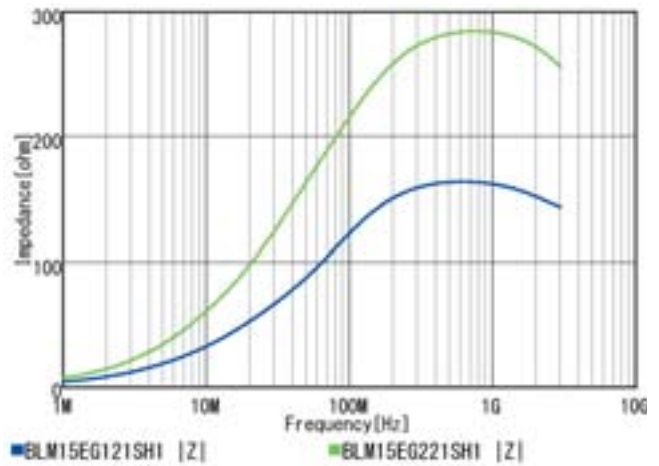

BLM15EG121SZ1/BLM15EG121SH1

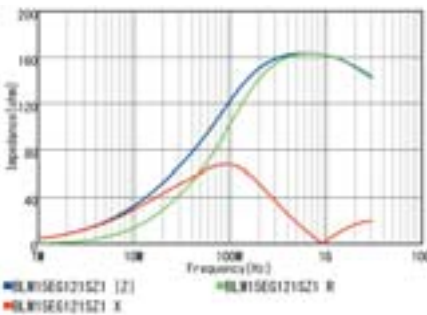

BLM15EG221SZ1/BLM15EG221SH1

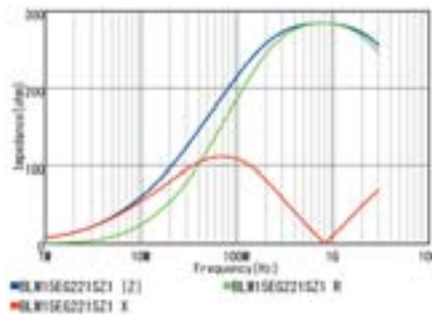

Continued on the following page. ↗

SMD Type  
 Chip Ferrite Bead

SMD Type  
 Chip EMIFIL®

SMD Type  
 Chip Common Mode Choke Coil

SMD Type  
 Block Type EMIFIL®

Lead Type  
 EMI Suppression Filters

SMD Type  
 Microchip Transformer (Balun)

Continued from the preceding page. ↘

## Derating of Rated Current

In operating temperature exceeding +85°C, derating of current is necessary for BLM15E series.  
Please apply the derating curve shown in chart according to the operating temperature.

Derating of Rated Current

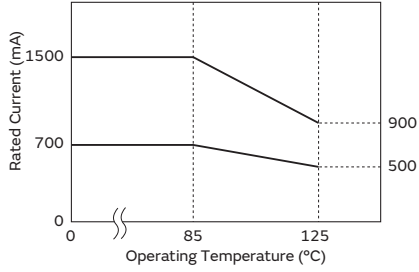

Chip Ferrite Bead  
SMD Type

Chip EMIFIL®  
SMD Type

Chip Common Mode Choke Coil  
SMD Type

Block Type EMIFIL®  
SMD Type

EMI Suppression Filters  
Lead Type

Microchip Transformer (Balun)  
SMD Type

# Chip Ferrite Bead SMD Type

## BLM15GA/GG Series 0402/1005(inch/mm)

### Appearance/Dimensions

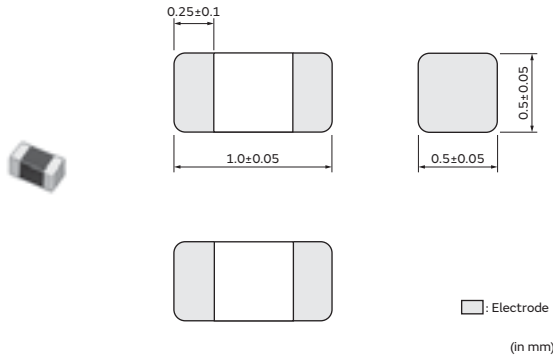

### Packaging

Code	Packaging	Minimum Quantity
D	ø180mm Paper Tape	10000
J	ø330mm Paper Tape	50000
B	Bulk(Bag)	1000

### Equivalent Circuit



(Resistance element becomes dominant at high frequencies.)

### Rated Value (□: packaging code)

Part Number		Impedance at 100MHz	Impedance at 1GHz	Rated Current at 85°C	Rated Current at 125°C	DC Resistance (Max.)
Infotainment	Powertrain/Safety					
BLM15GA750SZ1□	—	75Ω±25%	1000Ω±40%	200mA	200mA	1.3Ω
BLM15GG221SZ1□	—	220Ω±25%	600Ω±40%	300mA	300mA	0.7Ω
BLM15GG471SZ1□	—	470Ω±25%	1200Ω±40%	200mA	200mA	1.3Ω

Operating Temp. Range: -55°C to 125°C

### Z-f characteristics: BLM15GA/GG\_SZ1 series

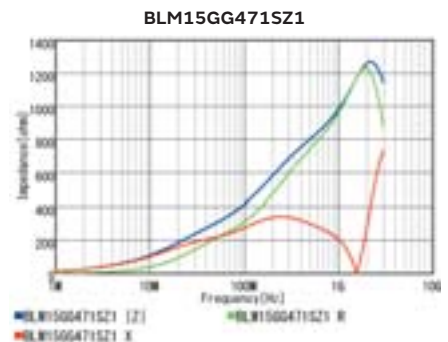
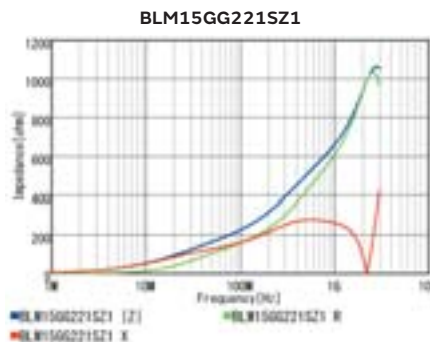
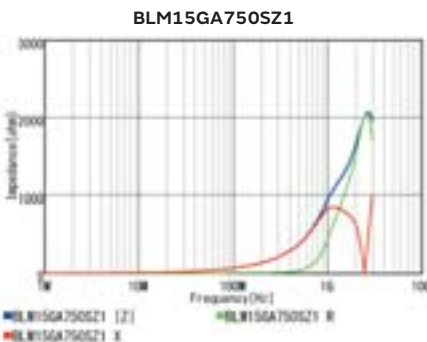
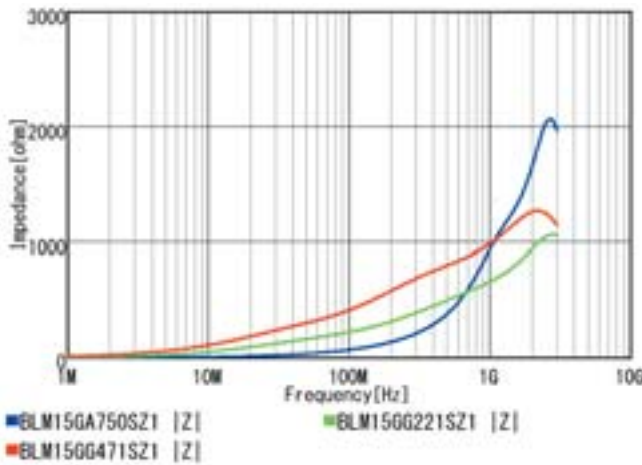

SMD Type  
 Chip Ferrite Bead

SMD Type  
 Chip EMIFIL®

SMD Type  
 Chip Common Mode Choke Coil

SMD Type  
 Block Type EMIFIL®

Lead Type  
 EMI Suppression Filters

SMD Type  
 Microchip Transformer (Balun)

# Chip Ferrite Bead SMD Type

## BLM18PG Series 0603/1608(inch/mm)

### Appearance/Dimensions

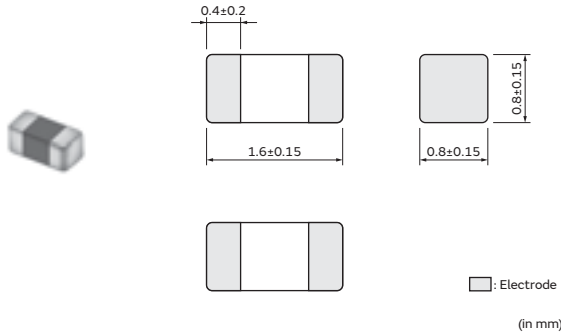

### Packaging

Code	Packaging	Minimum Quantity
D	ø180mm Paper Tape	4000
J	ø330mm Paper Tape	10000
B	Bulk(Bag)	1000

### Equivalent Circuit



(Resistance element becomes dominant at high frequencies.)

### Rated Value (□: packaging code)

Part Number		Impedance at 100MHz	Rated Current at 85°C	DC Resistance (Max.)
Infotainment	Powertrain/Safety			
BLM18PG300SZ1□	BLM18PG300SH1□	30Ω(Typ.)	1A	0.05Ω
BLM18PG330SZ1□	BLM18PG330SH1□	33Ω±25%	3A	0.025Ω
BLM18PG600SZ1□	BLM18PG600SH1□	60Ω(Typ.)	1A	0.1Ω
BLM18PG121SZ1□	BLM18PG121SH1□	120Ω±25%	2A	0.05Ω
BLM18PG181SZ1□	BLM18PG181SH1□	180Ω±25%	1.5A	0.09Ω
BLM18PG221SZ1□	BLM18PG221SH1□	220Ω±25%	1.4A	0.1Ω
BLM18PG331SZ1□	BLM18PG331SH1□	330Ω±25%	1.2A	0.15Ω
BLM18PG471SZ1□	BLM18PG471SH1□	470Ω±25%	1A	0.2Ω

Rated Current at 125°C: 1A  
 Operating Temp. Range: -55°C to 125°C

### Z-f characteristics: BLM18PG\_SZ1 series

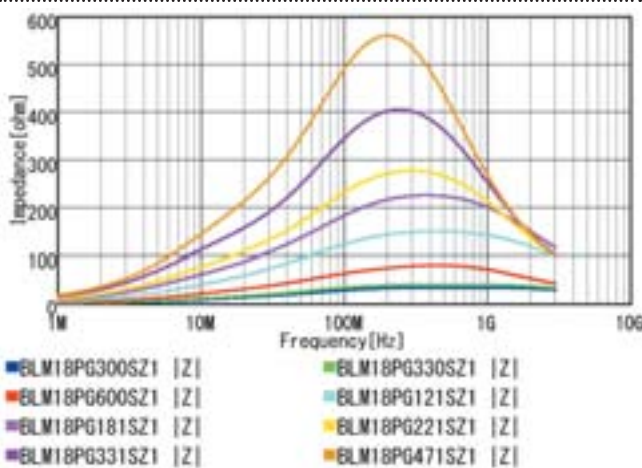

### Z-f characteristics: BLM18PG\_SH1 series

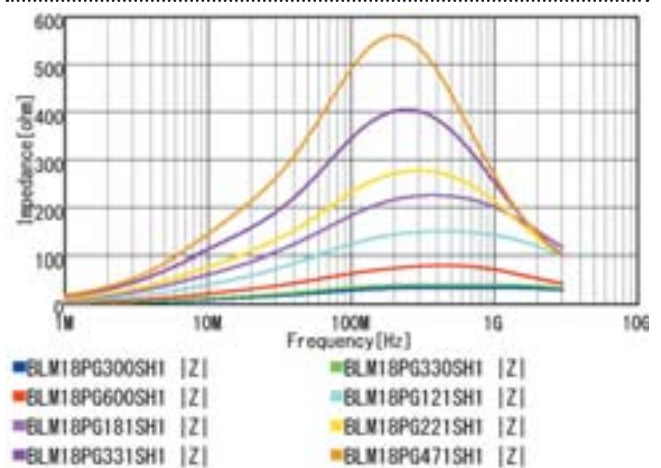

Continued on the following page. ↗

Continued from the preceding page. ↘

## Z-f characteristics

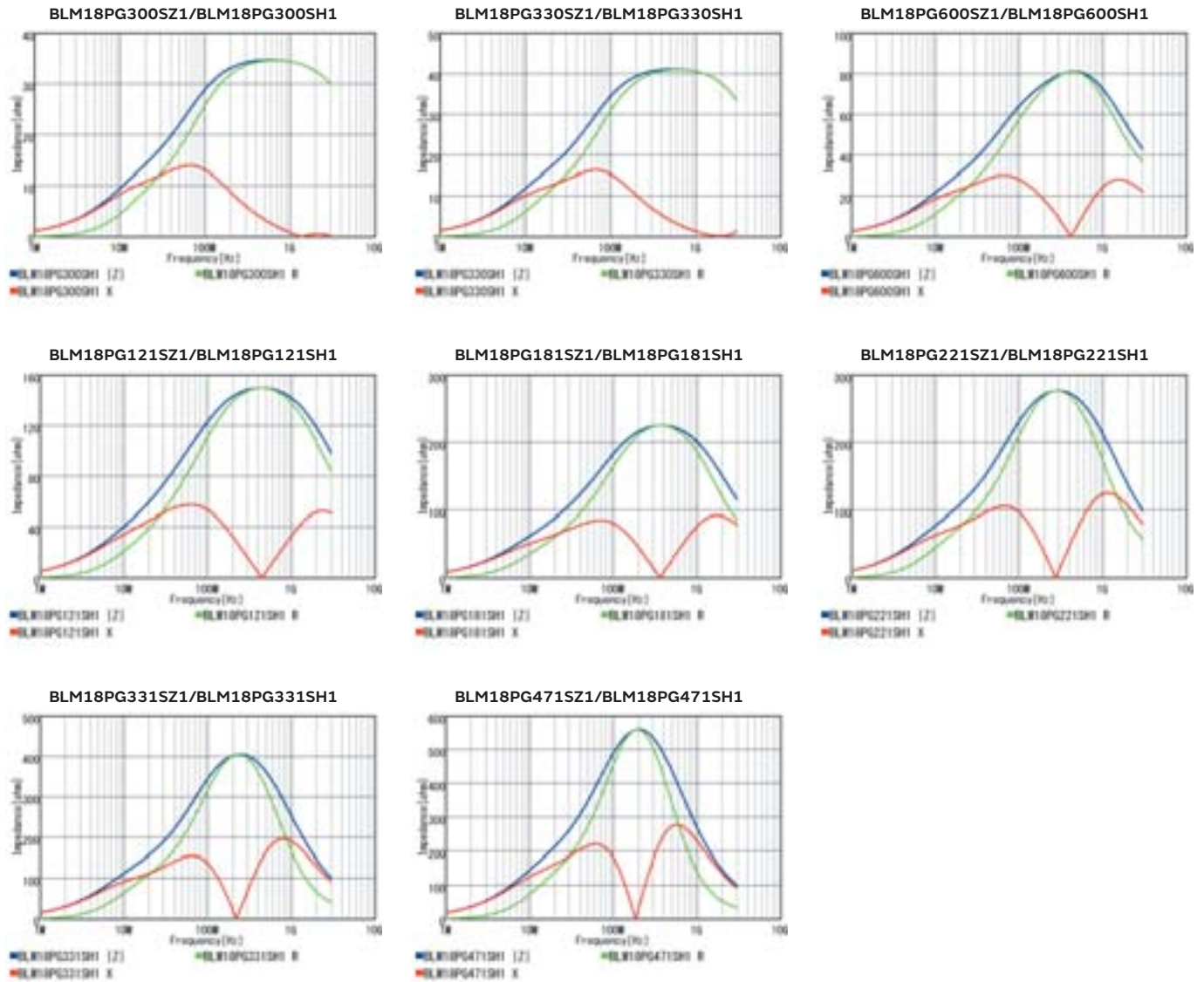

## Derating of Rated Current

In operating temperature exceeding +85°C, derating of current is necessary for BLM18PG series. Please apply the derating curve shown in chart according to the operating temperature.

Derating of Rated Current

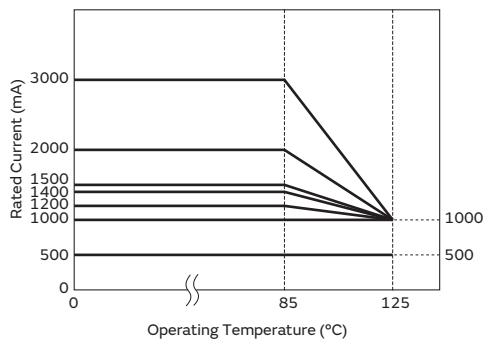

SMD Type  
 Chip Ferrite Bead

SMD Type  
 Chip EMIFIL®

SMD Type  
 Chip Common Mode Choke Coil

SMD Type  
 Block Type EMIFIL®

Lead Type  
 EMI Suppression Filters

SMD Type  
 Microchip Transformer (Balun)

# Chip Ferrite Bead SMD Type

## BLM18SG Series 0603/1608(inch/mm)

### Appearance/Dimensions

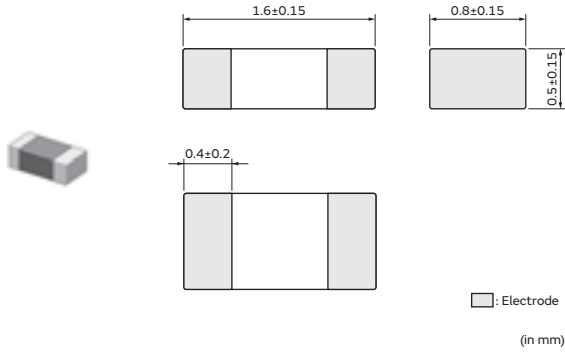

### Packaging

Code	Packaging	Minimum Quantity
D	ø180mm Paper Tape	10000
J	ø330mm Paper Tape	30000
B	Bulk(Bag)	1000

### Equivalent Circuit

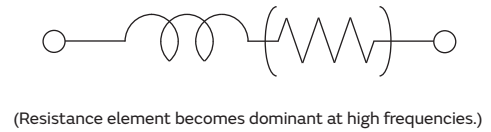

### Rated Value (□: packaging code)

Part Number		Impedance at 100MHz	Rated Current at 85°C	DC Resistance (Max.)
Infotainment	Powertrain/Safety			
BLM18SG260TZ1□	—	26Ω±25%	6A	0.007Ω
BLM18SG700TZ1□	—	70Ω±25%	4A	0.02Ω
BLM18SG121TZ1□	—	120Ω±25%	3A	0.025Ω
BLM18SG221TZ1□	—	220Ω±25%	2.5A	0.04Ω
BLM18SG331TZ1□	—	330Ω±25%	1.5A	0.07Ω

Rated Current at 125°C: 1A  
 Operating Temp. Range: -55°C to 125°C

### Z-f characteristics: BLM18SG\_TZ1 series

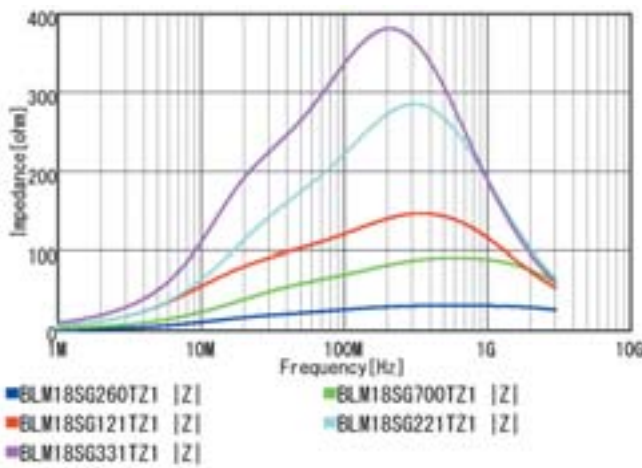

Continued on the following page. ↗

Continued from the preceding page. ↘

## Z-f characteristics

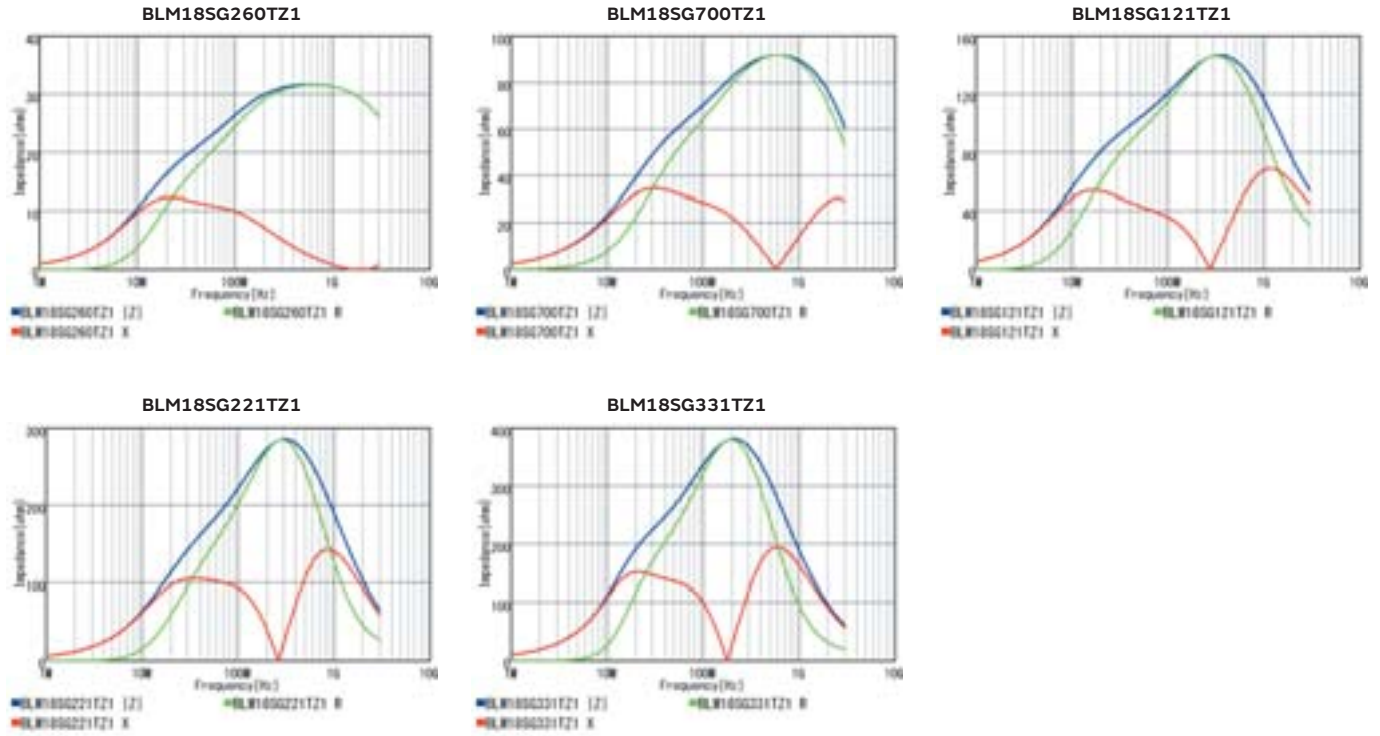

## Derating of Rated Current

In operating temperature exceeding +85°C, derating of current is necessary for BLM18SG\_T□1 series. Please apply the derating curve shown in chart according to the operating temperature.

Derating of Rated Current

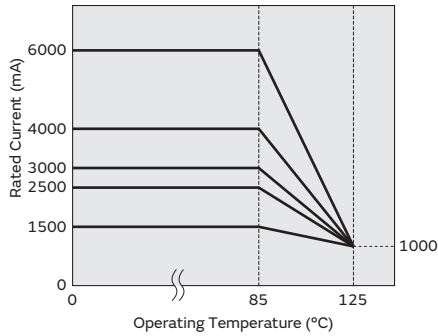

SMD Type  
 Chip Ferrite Bead

SMD Type  
 Chip EMIFIL®

SMD Type  
 Chip Common Mode Choke Coil

SMD Type  
 Block Type EMIFIL®

Lead Type  
 EMI Suppression Filters

SMD Type  
 Microchip Transformer (Balun)

Chip Ferrite Bead  
 SMD Type

Chip EMIFIL®  
 SMD Type

Chip Common Mode Choke Coil  
 SMD Type

Block Type EMIFIL®  
 SMD Type

EMI Suppression Filters  
 Lead Type

Microchip Transformer (Balun)  
 SMD Type

# Chip Ferrite Bead SMD Type

## BLM18SN Series 0603/1608(inch/mm)

### Appearance/Dimensions

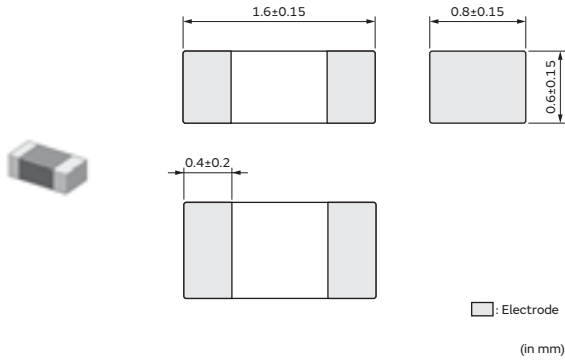

### Packaging

Code	Packaging	Minimum Quantity
D	ø180mm Paper Tape	4000
B	Bulk(Bag)	1000

### Equivalent Circuit

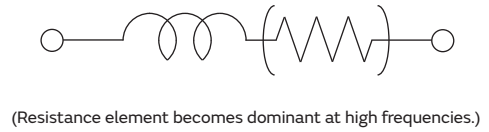

### Rated Value (□: packaging code)

Part Number		Impedance at 100MHz	Rated Current at 85°C	Rated Current at 125°C	DC Resistance (Max.)	Operating Temp. Range
Infotainment	Powertrain/Safety					
BLM18SN220TZ1□	BLM18SN220TH1□	22Ω±7Ω	8A	5A	0.004Ω	-55°C to 125°C

### Z-f characteristics

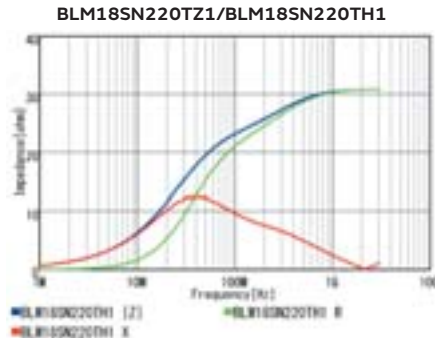

### Derating of Rated Current

In operating temperature exceeding +85°C, derating of current is necessary for BLM18SN series. Please apply the derating curve shown in chart according to the operating temperature.

Derating of Rated Current

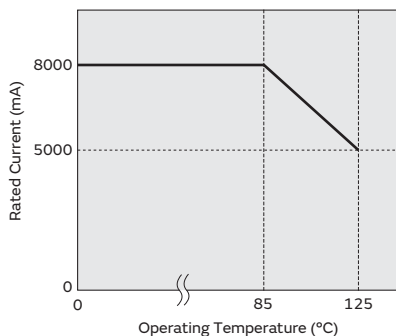



# Chip Ferrite Bead SMD Type

## BLM18KG Series 0603/1608(inch/mm)

### Appearance/Dimensions

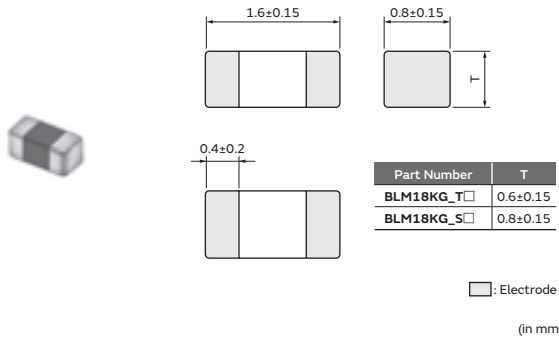

### Packaging

Code	Packaging	Minimum Quantity
D	ø180mm Paper Tape	4000
J	ø330mm Paper Tape	10000
B	Bulk(Bag)	1000

### Equivalent Circuit



(Resistance element becomes dominant at high frequencies.)

### Rated Value (□: packaging code)

Part Number		Impedance at 100MHz	Rated Current at 85°C	Rated Current at 125°C	DC Resistance (Max.)
Infotainment	Powertrain/Safety				
BLM18KG260TZ1□	BLM18KG260TH1□	26Ω±25%	6A	4A	0.007Ω
BLM18KG300TZ1□	BLM18KG300TH1□	30Ω±25%	5A	3.3A	0.01Ω
BLM18KG700TZ1□	BLM18KG700TH1□	70Ω±25%	3.5A	2.2A	0.022Ω
BLM18KG101TZ1□	BLM18KG101TH1□	100Ω±25%	3A	1.9A	0.03Ω
BLM18KG121TZ1□	BLM18KG121TH1□	120Ω±25%	3A	1.9A	0.03Ω
BLM18KG221SZ1□	BLM18KG221SH1□	220Ω±25%	2.2A	1.5A	0.05Ω
BLM18KG331SZ1□	BLM18KG331SH1□	330Ω±25%	1.7A	1.2A	0.08Ω
BLM18KG471SZ1□	BLM18KG471SH1□	470Ω±25%	1.5A	1A	0.13Ω
BLM18KG601SZ1□	BLM18KG601SH1□	600Ω±25%	1.3A	1A	0.15Ω
BLM18KG102SZ1□	BLM18KG102SH1□	1000Ω±25%	1A	800mA	0.2Ω

Operating Temp. Range: -55°C to 125°C

### Z-f characteristics: BLM18KG\_TZ1 series

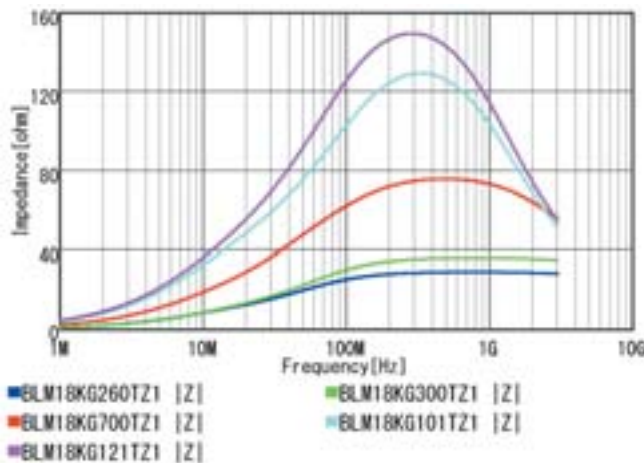

### Z-f characteristics: BLM18KG\_TH1 series

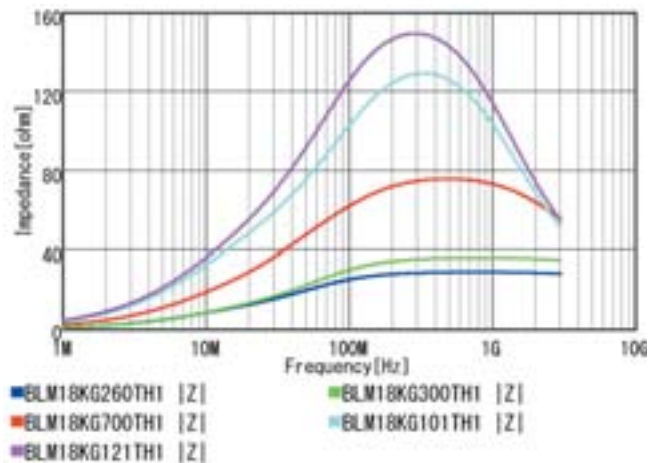

Continued on the following page. ↗

Continued from the preceding page. ↘

**Z-f characteristics: BLM18KG\_SZ1 series**

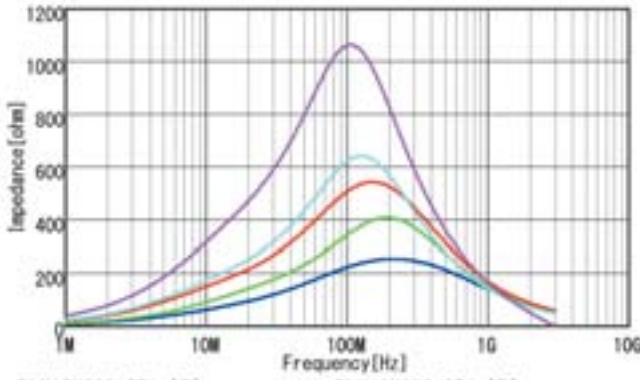

- BLM18KG221SZ1 [Z]
- BLM18KG331SZ1 [Z]
- BLM18KG471SZ1 [Z]
- BLM18KG601SZ1 [Z]
- BLM18KG102SZ1 [Z]

**Z-f characteristics: BLM18KG\_SH1 series**

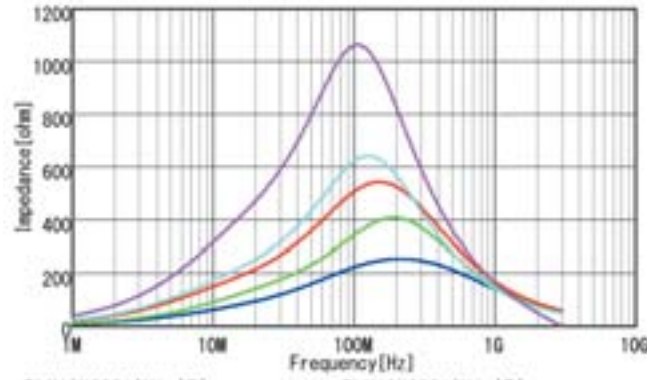

- BLM18KG221SH1 [Z]
- BLM18KG331SH1 [Z]
- BLM18KG471SH1 [Z]
- BLM18KG601SH1 [Z]
- BLM18KG102SH1 [Z]

**BLM18KG260TZ1/BLM18KG260TH1**

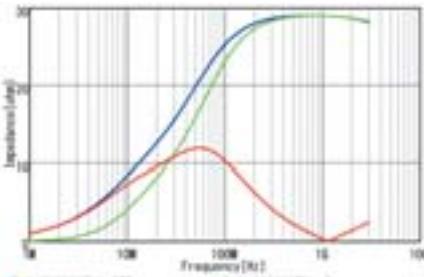

- BLM18KG260TH1 [Z]
- BLM18KG260TZ1 [Z]
- BLM18KG260TH1 X
- BLM18KG260TZ1 X

**BLM18KG300TZ1/BLM18KG300TH1**

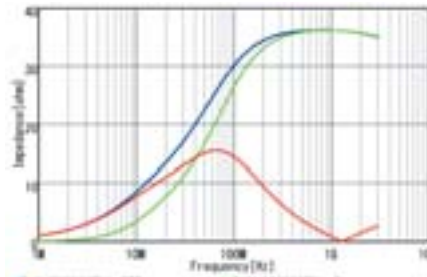

- BLM18KG300TH1 [Z]
- BLM18KG300TZ1 [Z]
- BLM18KG300TH1 X
- BLM18KG300TZ1 X

**BLM18KG700TZ1/BLM18KG700TH1**

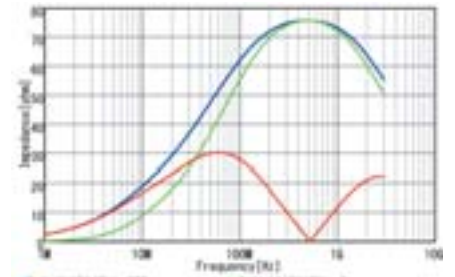

- BLM18KG700TH1 [Z]
- BLM18KG700TZ1 [Z]
- BLM18KG700TH1 X
- BLM18KG700TZ1 X

**BLM18KG101TZ1/BLM18KG101TH1**

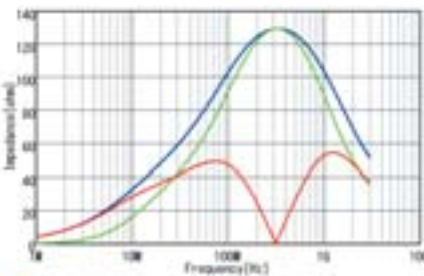

- BLM18KG101TH1 [Z]
- BLM18KG101TZ1 [Z]
- BLM18KG101TH1 X
- BLM18KG101TZ1 X

**BLM18KG121TZ1/BLM18KG121TH1**

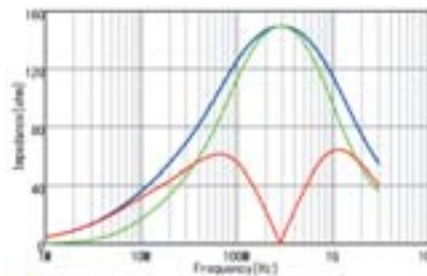

- BLM18KG121TH1 [Z]
- BLM18KG121TZ1 [Z]
- BLM18KG121TH1 X
- BLM18KG121TZ1 X

**BLM18KG221SZ1/BLM18KG221SH1**

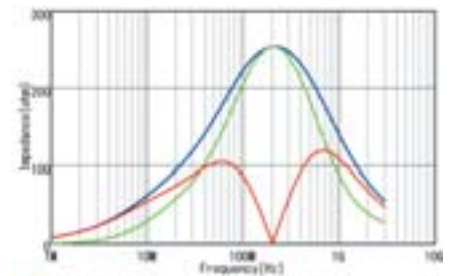

- BLM18KG221SH1 [Z]
- BLM18KG221SZ1 [Z]
- BLM18KG221SH1 X
- BLM18KG221SZ1 X

**BLM18KG331SZ1/BLM18KG331SH1**

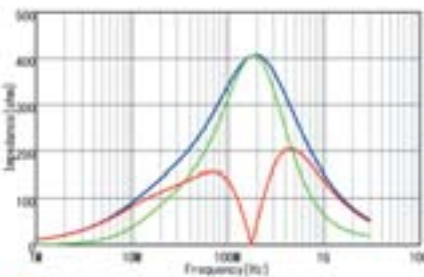

- BLM18KG331SH1 [Z]
- BLM18KG331SZ1 [Z]
- BLM18KG331SH1 X
- BLM18KG331SZ1 X

**BLM18KG471SZ1/BLM18KG471SH1**

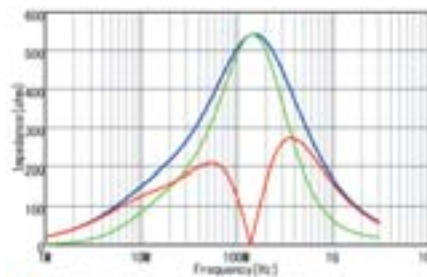

- BLM18KG471SH1 [Z]
- BLM18KG471SZ1 [Z]
- BLM18KG471SH1 X
- BLM18KG471SZ1 X

**BLM18KG601SZ1/BLM18KG601SH1**

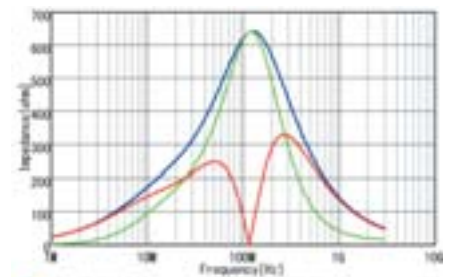

- BLM18KG601SH1 [Z]
- BLM18KG601SZ1 [Z]
- BLM18KG601SH1 X
- BLM18KG601SZ1 X

Continued on the following page. ↗

Chip Ferrite Bead  
SMD Type

Chip EMIFIL®  
SMD Type

Chip Common Mode Choke Coil  
SMD Type

Block Type EMIFIL®  
SMD Type

EMI Suppression Filters  
Lead Type

Microchip Transformer (Balun)  
SMD Type

Continued from the preceding page. ↘

## Z-f characteristics

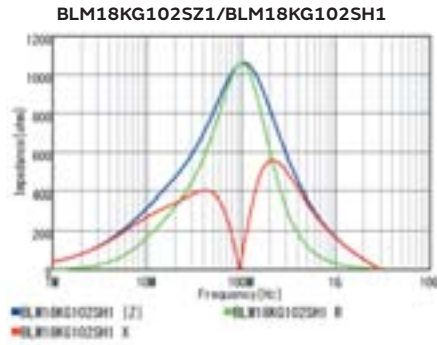

## Derating of Rated Current

In operating temperature exceeding +85°C, derating of current is necessary for BLM18KG series.  
 Please apply the derating curve shown in chart according to the operating temperature.

Derating of Rated Current

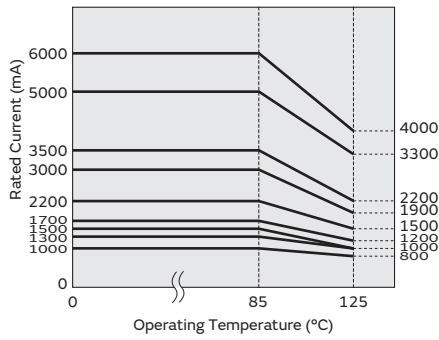

# Chip Ferrite Bead SMD Type

## BLM18KG(150°C available) Series 0603/1608(inch/mm)

### Appearance/Dimensions

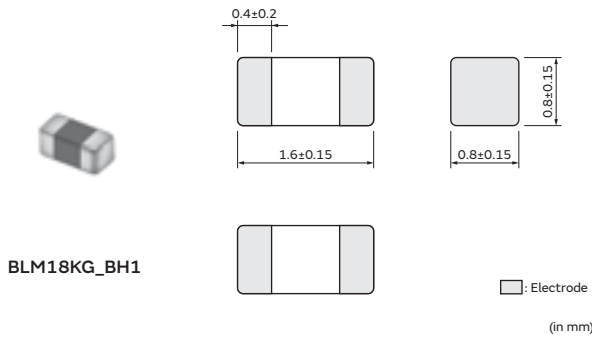

### Packaging

Code	Packaging	Minimum Quantity
D	ø180mm Paper Tape	4000
B	Bulk(Bag)	1000

### Equivalent Circuit

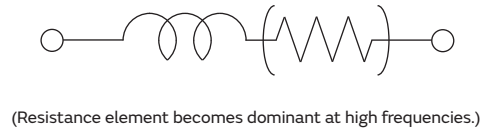

### Appearance/Dimensions

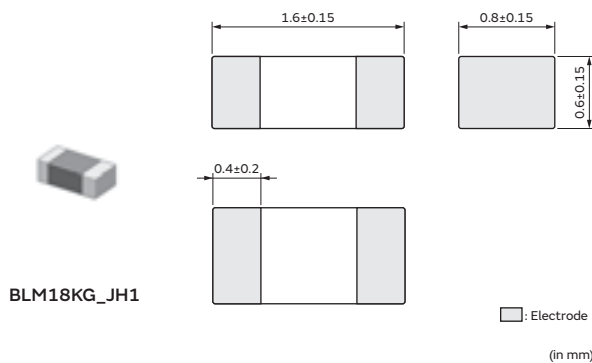

### Rated Value (□: packaging code)

Part Number		Impedance at 100MHz	Rated Current at 85°C	Rated Current at 125°C	DC Resistance (Max.)
Infotainment	Powertrain/Safety				
—	BLM18KG221BH1□	220Ω±25%	1.5A	1.5A	0.05Ω
—	BLM18KG331BH1□	330Ω±25%	1.2A	1.2A	0.08Ω
—	BLM18KG471BH1□	470Ω±25%	1A	1A	0.13Ω
—	BLM18KG601BH1□	600Ω±25%	1A	1A	0.15Ω
—	BLM18KG102BH1□	1000Ω±25%	800mA	800mA	0.2Ω
—	BLM18KG260JH1□	26Ω±25%	4A	4A	0.007Ω
—	BLM18KG300JH1□	30Ω±25%	3.3A	3.3A	0.01Ω
—	BLM18KG700JH1□	70Ω±25%	2.2A	2.2A	0.022Ω
—	BLM18KG101JH1□	100Ω±25%	1.9A	1.9A	0.03Ω
—	BLM18KG121JH1□	120Ω±25%	1.9A	1.9A	0.03Ω

Rated Current at 150°C: 10mA  
 Operating Temp. Range: -55°C to 150°C

Continued on the following page. ↗

Chip Ferrite Bead SMD Type  
 Chip Common Mode Choke Coil SMD Type  
 Block Type EMIFIL® SMD Type  
 EMI Suppression Filters Lead Type  
 Microchip Transformer (Balun) SMD Type

Continued from the preceding page. ↘

**Z-f characteristics: BLM18KG\_BH1 series**

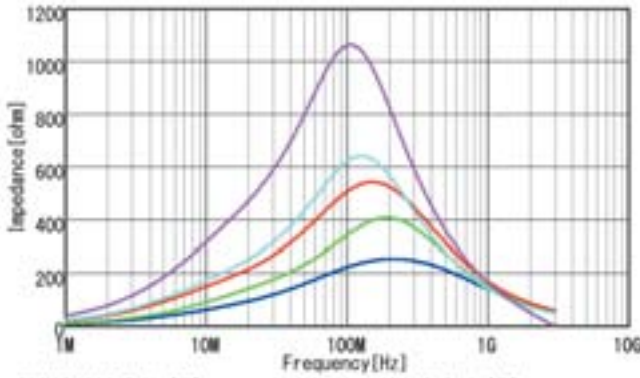

- BLM18KG221BH1 [Z]      ■ BLM18KG331BH1 [Z]
- BLM18KG471BH1 [Z]      ■ BLM18KG601BH1 [Z]
- BLM18KG102BH1 [Z]

**Z-f characteristics: BLM18KG\_JH1 series**

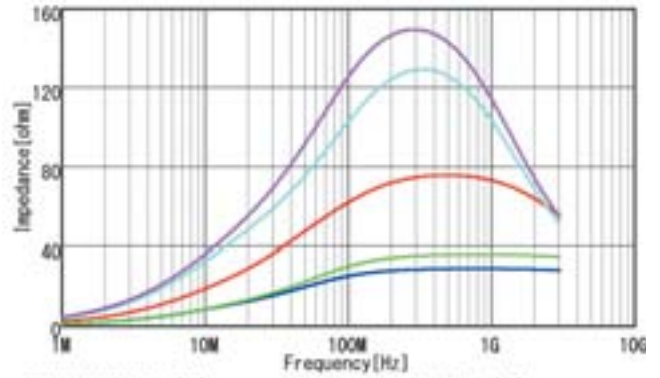

- BLM18KG260JH1 [Z]      ■ BLM18KG300JH1 [Z]
- BLM18KG700JH1 [Z]      ■ BLM18KG101JH1 [Z]
- BLM18KG121JH1 [Z]

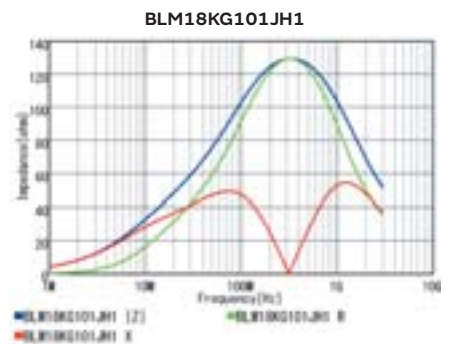
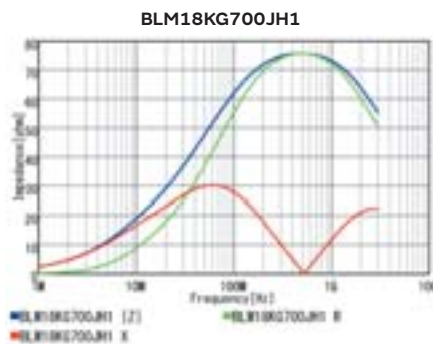
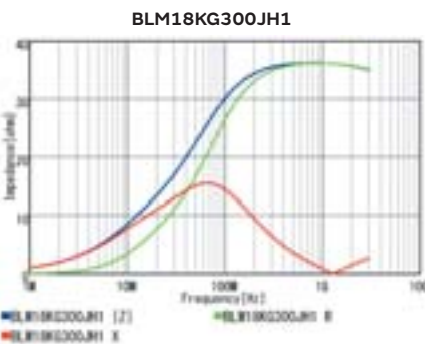
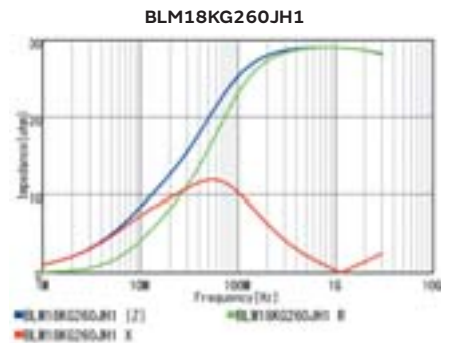
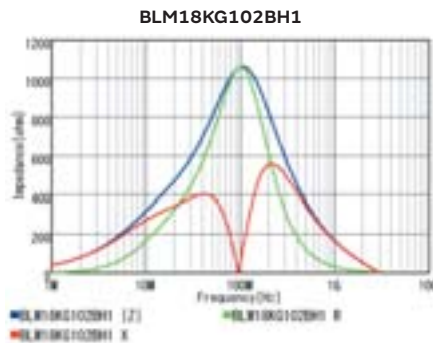
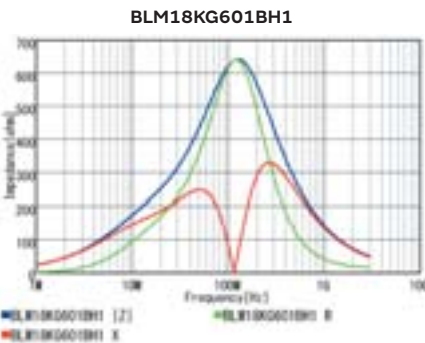
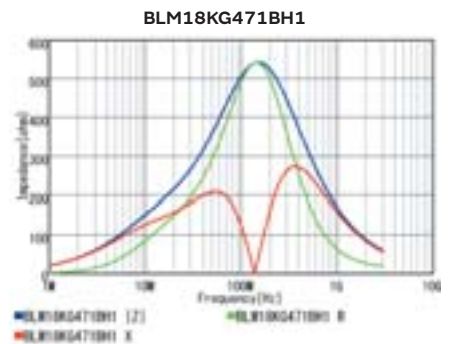
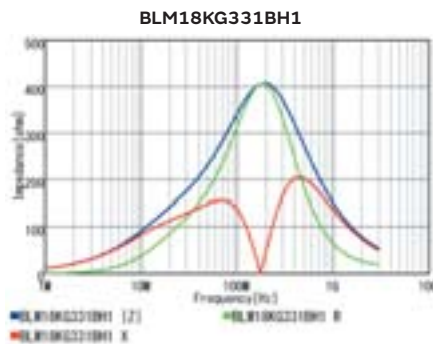
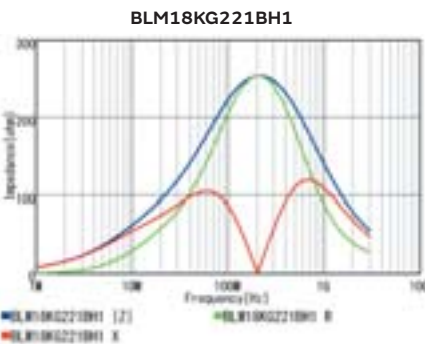

Continued on the following page. ↗

SMD Type Chip Ferrite Bead  
 SMD Type Chip EMIFIL®  
 SMD Type Chip Common Mode Choke Coil  
 SMD Type Block Type EMIFIL®  
 Lead Type EMI Suppression Filters  
 SMD Type Microchip Transformer (Balun)

Continued from the preceding page. ↘

## Z-f characteristics

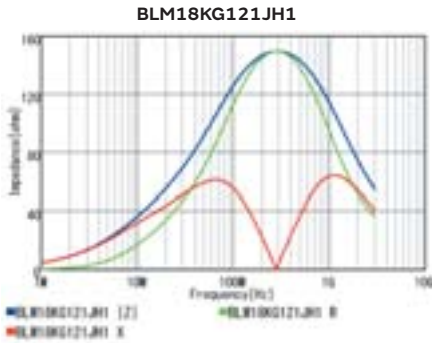

## Derating of Rated Current

In operating temperature exceeding +125°C, derating of current is necessary for BLM18KG\_JH1/\_BH1 series. Please apply the derating curve shown in chart according to the operating temperature.

Derating of Rated Current

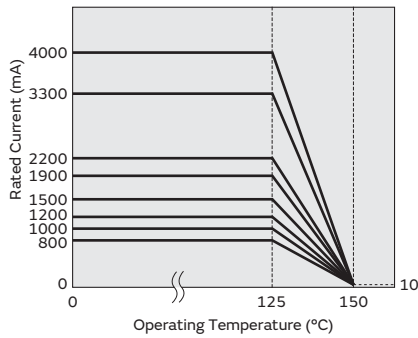

Chip Ferrite Bead  
 SMD Type

Chip EMIFIL®  
 SMD Type

Chip Common Mode Choke Coil  
 SMD Type

Block Type EMIFIL®  
 SMD Type

EMI Suppression Filters  
 Lead Type

Microchip Transformer (Balun)  
 SMD Type

# Chip Ferrite Bead SMD Type

## BLM18AG Series 0603/1608(inch/mm)

### Appearance/Dimensions

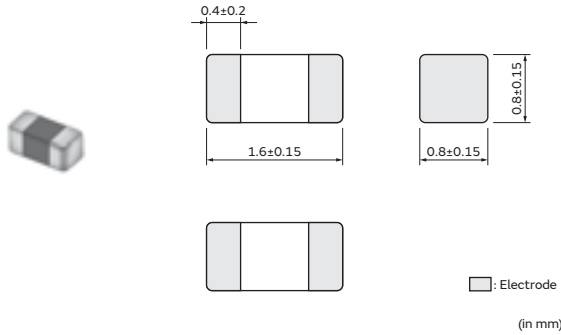

### Packaging

Code	Packaging	Minimum Quantity
D	ø180mm Paper Tape	4000
J	ø330mm Paper Tape	10000
B	Bulk(Bag)	1000

### Equivalent Circuit



(Resistance element becomes dominant at high frequencies.)

### Rated Value (□: packaging code)

Part Number		Impedance at 100MHz	Rated Current at 85°C	Rated Current at 125°C	DC Resistance (Max.)
Infotainment	Powertrain/Safety				
BLM18AG121SZ1□	BLM18AG121SH1□	120Ω±25%	800mA	800mA	0.18Ω
BLM18AG151SZ1□	BLM18AG151SH1□	150Ω±25%	700mA	700mA	0.25Ω
BLM18AG221SZ1□	BLM18AG221SH1□	220Ω±25%	700mA	700mA	0.25Ω
BLM18AG331SZ1□	BLM18AG331SH1□	330Ω±25%	600mA	600mA	0.3Ω
BLM18AG471SZ1□	BLM18AG471SH1□	470Ω±25%	550mA	550mA	0.35Ω
BLM18AG601SZ1□	BLM18AG601SH1□	600Ω±25%	500mA	500mA	0.38Ω
BLM18AG102SZ1□	BLM18AG102SH1□	1000Ω±25%	450mA	450mA	0.5Ω

Operating Temp. Range: -55°C to 125°C

### Z-f characteristics: BLM18AG\_SZ1 series

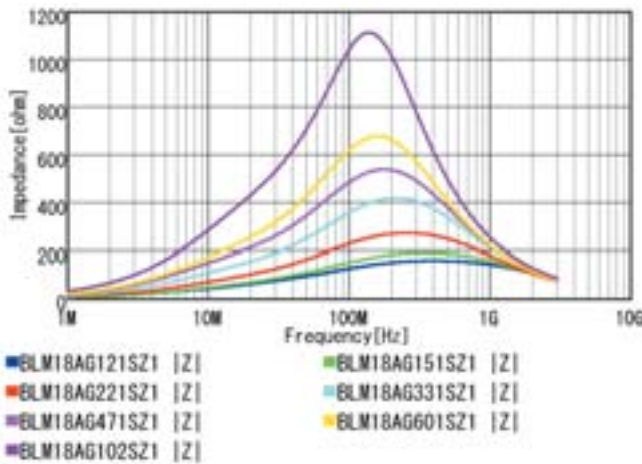

### Z-f characteristics: BLM18AG\_SH1 series

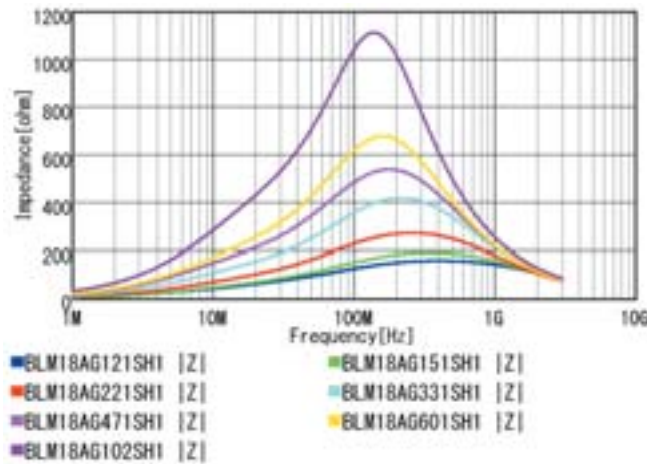

Continued on the following page. ↗

Continued from the preceding page. ↘

## Z-f characteristics

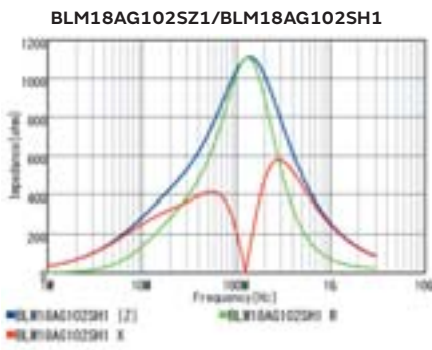
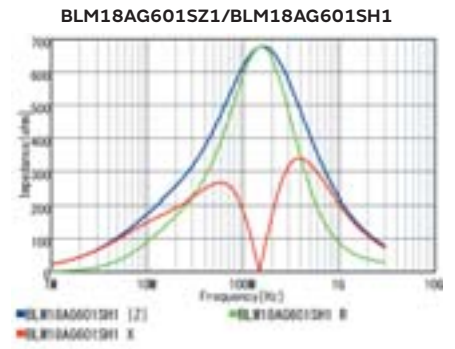
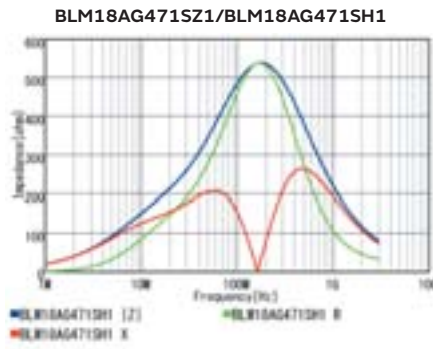
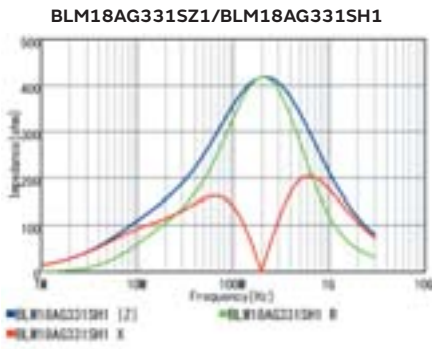
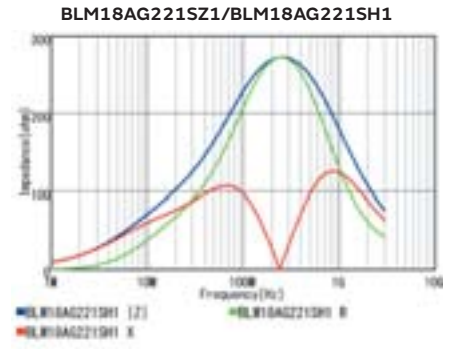
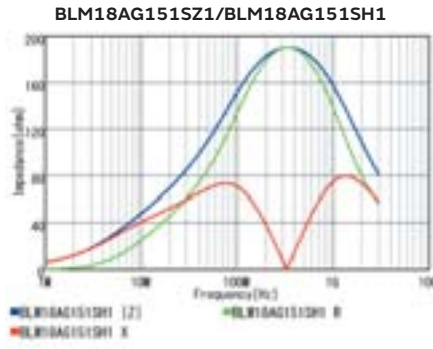
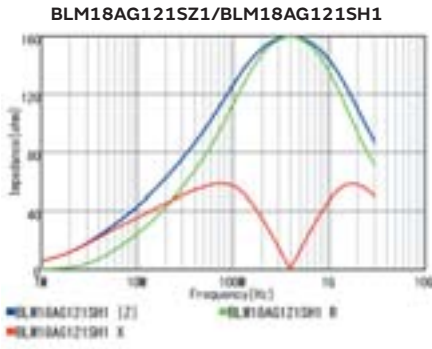

Chip Ferrite Bead  
 SMD Type

Chip EMIFIL®  
 SMD Type

Chip Common Mode Choke Coil  
 SMD Type

Block Type EMIFIL®  
 SMD Type

EMI Suppression Filters  
 Lead Type

Microchip Transformer (Balun)  
 SMD Type



# Chip Ferrite Bead SMD Type

## BLM18AG(for conductive glue mounting) Series 0603/1608(inch/mm)

### Appearance/Dimensions

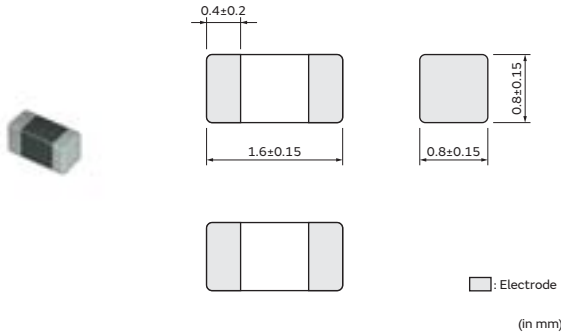

### Packaging

Code	Packaging	Minimum Quantity
D	ø180mm Paper Tape	4000
J	ø330mm Paper Tape	10000
B	Bulk(Bag)	1000

### Equivalent Circuit



(Resistance element becomes dominant at high frequencies.)

### Rated Value (□: packaging code)

Part Number		Impedance at 100MHz	Rated Current at 85°C	Rated Current at 125°C	Rated Current at 150°C	DC Resistance (Max.)
Infotainment	Powertrain/Safety					
—	BLM18AG471WH1□	470Ω±25%	1A	1A	500mA	0.2Ω
—	BLM18AG102WH1□	1000Ω±25%	200mA	200mA	100mA	0.7Ω

Operating Temp. Range: -55°C to 150°C

### Z-f characteristics: BLM18AG\_WH1 series

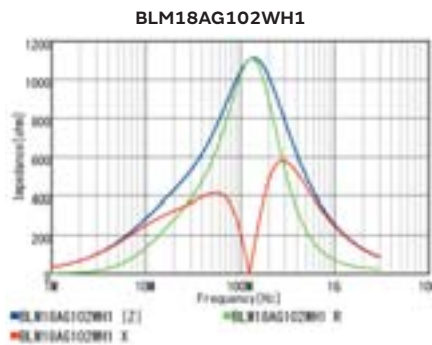
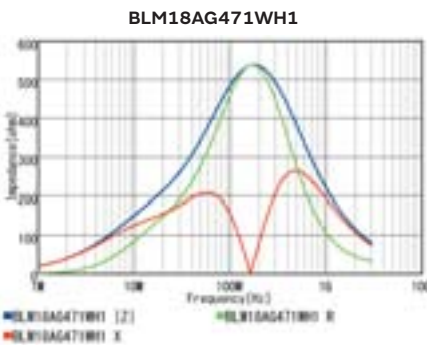
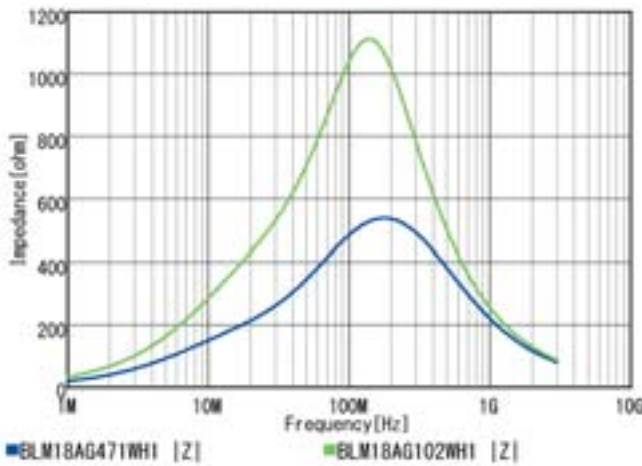

Continued on the following page. ↗

SMD Type  
 Chip Ferrite Bead

SMD Type  
 Chip EMIFIL®

SMD Type  
 Chip Common Mode Choke Coil

SMD Type  
 Block Type EMIFIL®

Lead Type  
 EMI Suppression Filters

SMD Type  
 Microchip Transformer (Balun)

Continued from the preceding page. ↘

## Derating of Rated Current

In operating temperature exceeding +125°C, derating of current is necessary for BLM18AG\_WH1 series. Please apply the derating curve shown in chart according to the operating temperature.

Derating of Rated Current

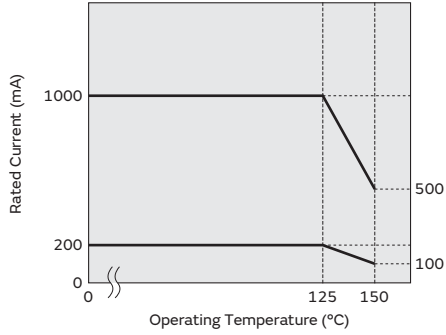

Chip Ferrite Bead  
SMD Type

Chip EMIFIL®  
SMD Type

Chip Common Mode Choke Coil  
SMD Type

Block Type EMIFIL®  
SMD Type

EMI Suppression Filters  
Lead Type

Microchip Transformer (Balun)  
SMD Type

# Chip Ferrite Bead SMD Type

## BLM18AG(150°C available) Series 0603/1608(inch/mm)

### Appearance/Dimensions

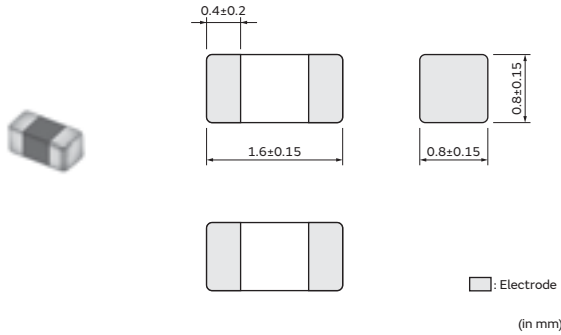

### Packaging

Code	Packaging	Minimum Quantity
D	ø180mm Paper Tape	4000
B	Bulk(Bag)	1000

### Equivalent Circuit

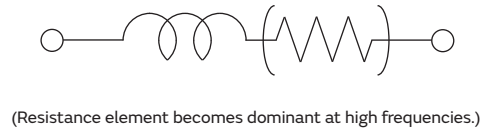

### Rated Value (□: packaging code)

Part Number		Impedance at 100MHz	Rated Current at 85°C	Rated Current at 125°C	DC Resistance (Max.)
Infotainment	Powertrain/Safety				
—	BLM18AG121BH1□	120Ω±25%	800mA	800mA	0.18Ω
—	BLM18AG151BH1□	150Ω±25%	700mA	700mA	0.25Ω
—	BLM18AG221BH1□	220Ω±25%	700mA	700mA	0.25Ω
—	BLM18AG331BH1□	330Ω±25%	600mA	600mA	0.3Ω
—	BLM18AG471BH1□	470Ω±25%	550mA	550mA	0.35Ω
—	BLM18AG601BH1□	600Ω±25%	500mA	500mA	0.38Ω
—	BLM18AG102BH1□	1000Ω±25%	450mA	450mA	0.5Ω

Rated Current at 150°C: 10mA  
 Operating Temp. Range: -55°C to 150°C

### Z-f characteristics: BLM18AG\_BH1 series

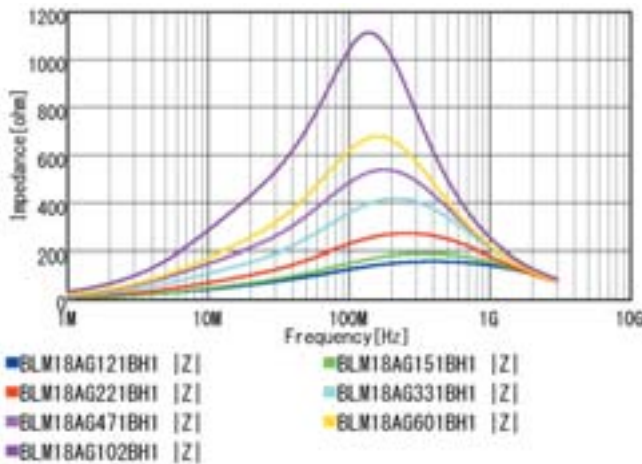

Continued on the following page. ↗

Continued from the preceding page. ↘

## Z-f characteristics

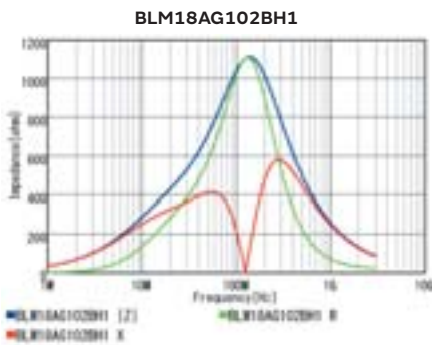
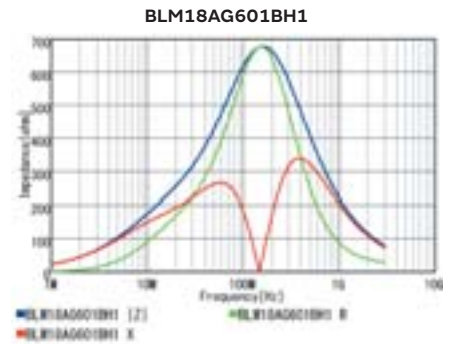
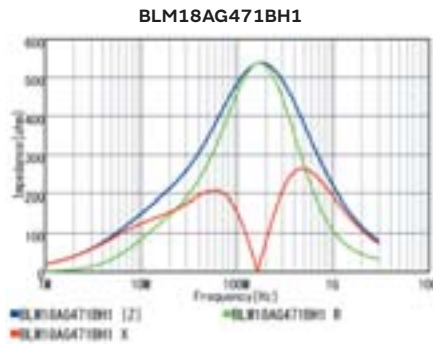
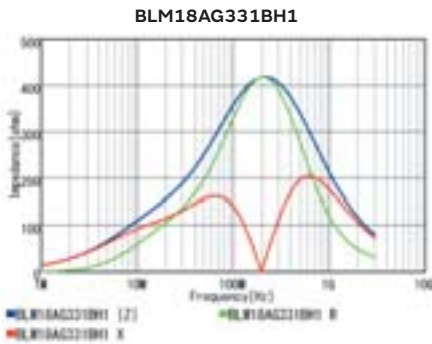
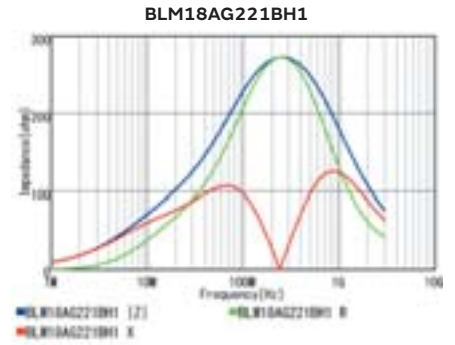
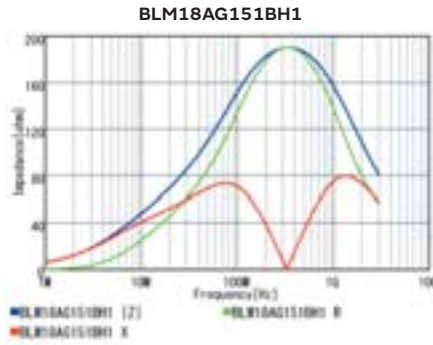
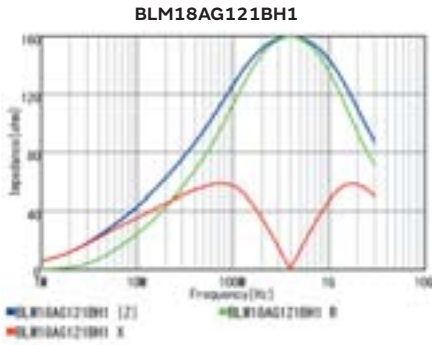

## Derating of Rated Current

In operating temperature exceeding +125°C, derating of current is necessary for BLM18AG\_BH1 series. Please apply the derating curve shown in chart according to the operating temperature.

Derating of Rated Current

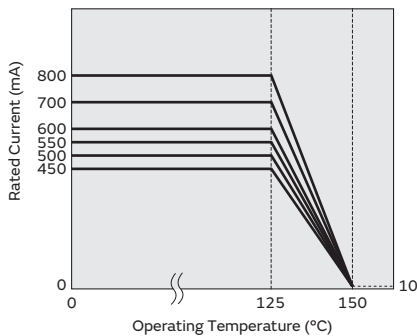

# Chip Ferrite Bead SMD Type

## BLM18BA/BB/BD Series 0603/1608(inch/mm)

### Appearance/Dimensions

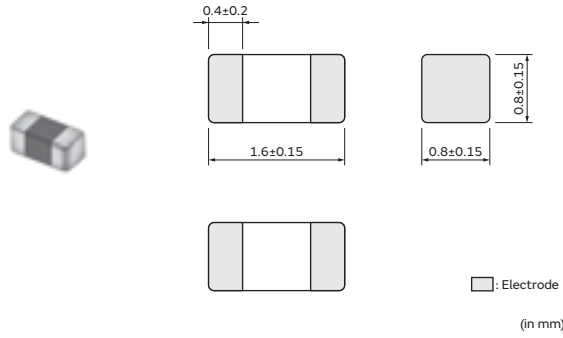

### Packaging

Code	Packaging	Minimum Quantity
D	ø180mm Paper Tape	4000
J	ø330mm Paper Tape	10000
B	Bulk(Bag)	1000

### Equivalent Circuit



(Resistance element becomes dominant at high frequencies.)

### Rated Value (□: packaging code)

Part Number		Impedance at 100MHz	Rated Current at 85°C	Rated Current at 125°C	DC Resistance (Max.)
Infotainment	Powertrain/Safety				
BLM18BA050SZ1□	BLM18BA050SH1□	5Ω±25%	500mA	500mA	0.2Ω
BLM18BA100SZ1□	BLM18BA100SH1□	10Ω±25%	500mA	500mA	0.25Ω
BLM18BA220SZ1□	BLM18BA220SH1□	22Ω±25%	500mA	500mA	0.35Ω
BLM18BA470SZ1□	BLM18BA470SH1□	47Ω±25%	300mA	300mA	0.55Ω
BLM18BA750SZ1□	BLM18BA750SH1□	75Ω±25%	300mA	300mA	0.7Ω
BLM18BA121SZ1□	BLM18BA121SH1□	120Ω±25%	200mA	200mA	0.9Ω
BLM18BB050SZ1□	BLM18BB050SH1□	5Ω±25%	800mA	800mA	0.05Ω
BLM18BB100SZ1□	BLM18BB100SH1□	10Ω±25%	700mA	700mA	0.1Ω
BLM18BB220SZ1□	BLM18BB220SH1□	22Ω±25%	700mA	700mA	0.2Ω
BLM18BB470SZ1□	BLM18BB470SH1□	47Ω±25%	600mA	600mA	0.25Ω
BLM18BB600SZ1□	BLM18BB600SH1□	60Ω±25%	600mA	600mA	0.25Ω
BLM18BB750SZ1□	BLM18BB750SH1□	75Ω±25%	600mA	600mA	0.3Ω
BLM18BB121SZ1□	BLM18BB121SH1□	120Ω±25%	550mA	550mA	0.3Ω
BLM18BB141SZ1□	BLM18BB141SH1□	140Ω±25%	500mA	500mA	0.35Ω
BLM18BB151SZ1□	BLM18BB151SH1□	150Ω±25%	450mA	450mA	0.37Ω
BLM18BB221SZ1□	BLM18BB221SH1□	220Ω±25%	450mA	450mA	0.45Ω
BLM18BB331SZ1□	BLM18BB331SH1□	330Ω±25%	400mA	400mA	0.58Ω
BLM18BB471SZ1□	BLM18BB471SH1□	470Ω±25%	300mA	300mA	0.85Ω
BLM18BD470SZ1□	BLM18BD470SH1□	47Ω±25%	500mA	500mA	0.3Ω
BLM18BD121SZ1□	BLM18BD121SH1□	120Ω±25%	300mA	300mA	0.4Ω
BLM18BD151SZ1□	BLM18BD151SH1□	150Ω±25%	300mA	300mA	0.4Ω
BLM18BD221SZ1□	BLM18BD221SH1□	220Ω±25%	250mA	250mA	0.45Ω
BLM18BD331SZ1□	BLM18BD331SH1□	330Ω±25%	250mA	250mA	0.5Ω
BLM18BD421SZ1□	BLM18BD421SH1□	420Ω±25%	250mA	250mA	0.55Ω
BLM18BD471SZ1□	BLM18BD471SH1□	470Ω±25%	250mA	250mA	0.55Ω
BLM18BD601SZ1□	BLM18BD601SH1□	600Ω±25%	200mA	200mA	0.65Ω
BLM18BD102SZ1□	BLM18BD102SH1□	1000Ω±25%	200mA	200mA	0.85Ω
BLM18BD152SZ1□	BLM18BD152SH1□	1500Ω±25%	150mA	150mA	1.2Ω
BLM18BD182SZ1□	BLM18BD182SH1□	1800Ω±25%	150mA	150mA	1.5Ω
BLM18BD222SZ1□	BLM18BD222SH1□	2200Ω±25%	150mA	150mA	1.5Ω
BLM18BD252SZ1□	BLM18BD252SH1□	2500Ω±25%	150mA	150mA	1.5Ω

Operating Temp. Range: -55°C to 125°C

Continued on the following page. ↗

SMD Type  
Chip Ferrite Bead

SMD Type  
Chip EMIFIL®

SMD Type  
Chip Common Mode Choke Coil

SMD Type  
Block Type EMIFIL®

Lead Type  
EMI Suppression Filters

SMD Type  
Microchip Transformer (Balun)

Continued from the preceding page. ↘

**Z-f characteristics: BLM18BA\_SZ1 series**

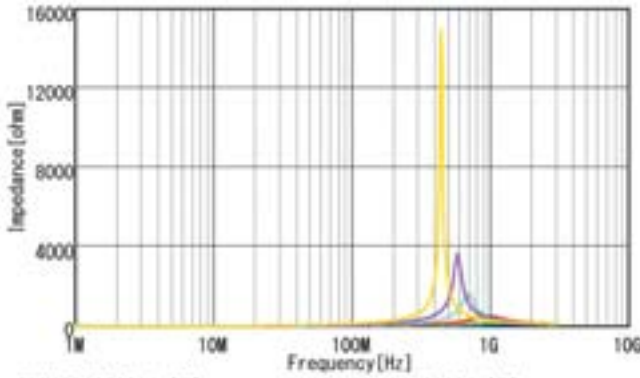

- ELM18BA050SZ1 [Z]
- ELM18BA220SZ1 [Z]
- ELM18BA750SZ1 [Z]
- ELM18BA100SZ1 [Z]
- ELM18BA470SZ1 [Z]
- ELM18BA121SZ1 [Z]

**Z-f characteristics: BLM18BA\_SH1 series**

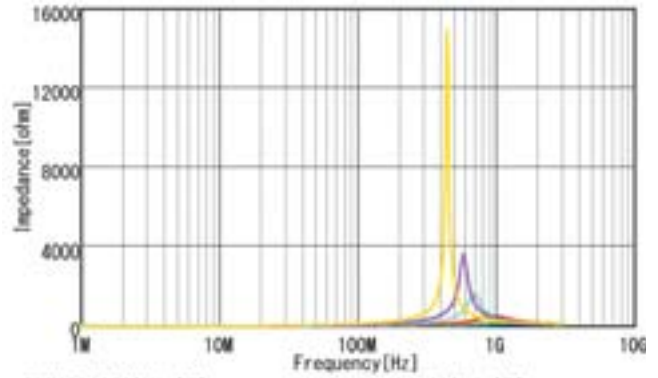

- ELM18BA050SH1 [Z]
- ELM18BA220SH1 [Z]
- ELM18BA750SH1 [Z]
- ELM18BA100SH1 [Z]
- ELM18BA470SH1 [Z]
- ELM18BA121SH1 [Z]

**Z-f characteristics: BLM18BB\_SZ1 series**

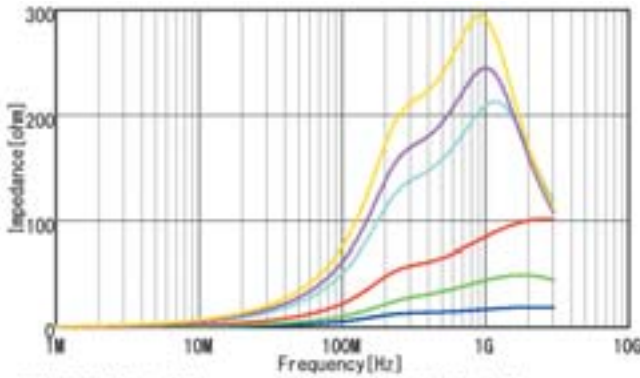

- ELM18BB050SZ1 [Z]
- ELM18BB220SZ1 [Z]
- ELM18BB600SZ1 [Z]
- ELM18BB100SZ1 [Z]
- ELM18BB470SZ1 [Z]
- ELM18BB750SZ1 [Z]

**Z-f characteristics: BLM18BB\_SH1 series**

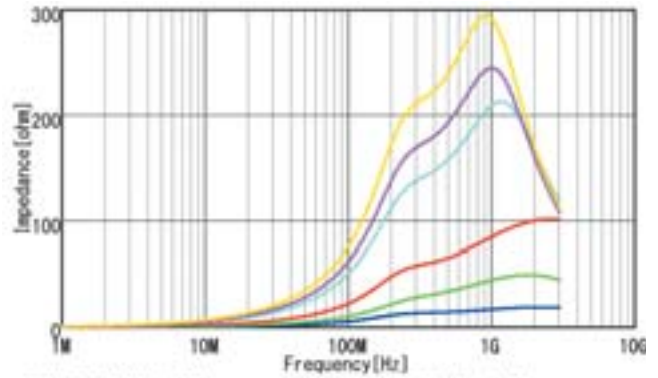

- ELM18BB050SH1 [Z]
- ELM18BB220SH1 [Z]
- ELM18BB600SH1 [Z]
- ELM18BB100SH1 [Z]
- ELM18BB470SH1 [Z]
- ELM18BB750SH1 [Z]

**Z-f characteristics: BLM18BB\_SZ1 series**

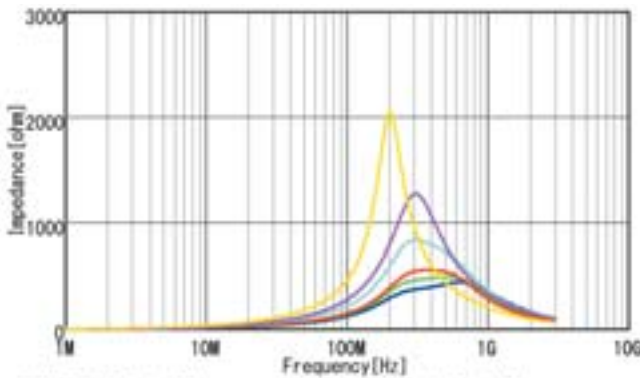

- ELM18BB121SZ1 [Z]
- ELM18BB151SZ1 [Z]
- ELM18BB331SZ1 [Z]
- ELM18BB141SZ1 [Z]
- ELM18BB221SZ1 [Z]
- ELM18BB471SZ1 [Z]

**Z-f characteristics: BLM18BB\_SH1 series**

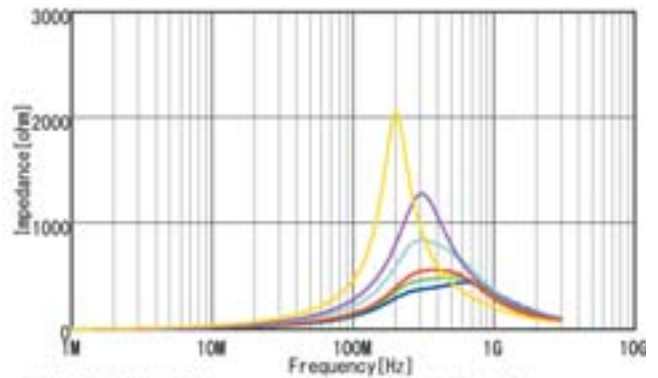

- ELM18BB121SH1 [Z]
- ELM18BB151SH1 [Z]
- ELM18BB331SH1 [Z]
- ELM18BB141SH1 [Z]
- ELM18BB221SH1 [Z]
- ELM18BB471SH1 [Z]

Continued on the following page. ↗

Chip Ferrite Bead SMD Type  
 Chip Common Mode Choke Coil SMD Type  
 Block Type EMIFIL® SMD Type  
 EMI Suppression Filters Lead Type  
 Microchip Transformer (Balun) SMD Type

Continued from the preceding page. ↘

**Z-f characteristics: BLM18BD\_SZ1 series**

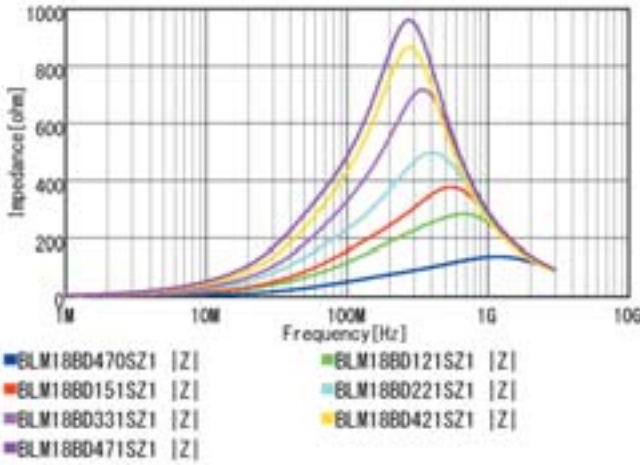

**Z-f characteristics: BLM18BD\_SH1 series**

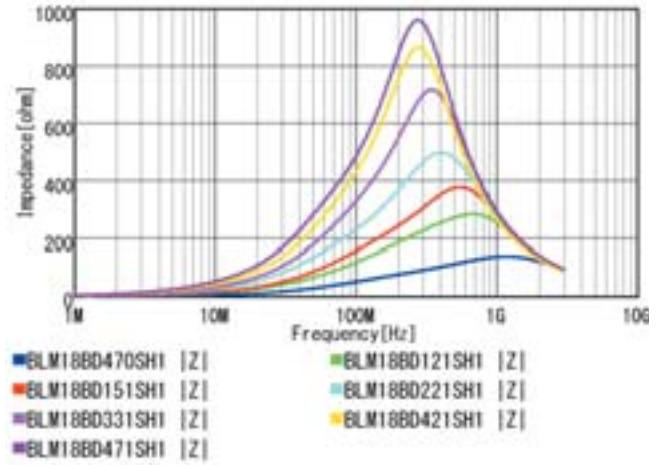

**Z-f characteristics: BLM18BD\_SZ1 series**

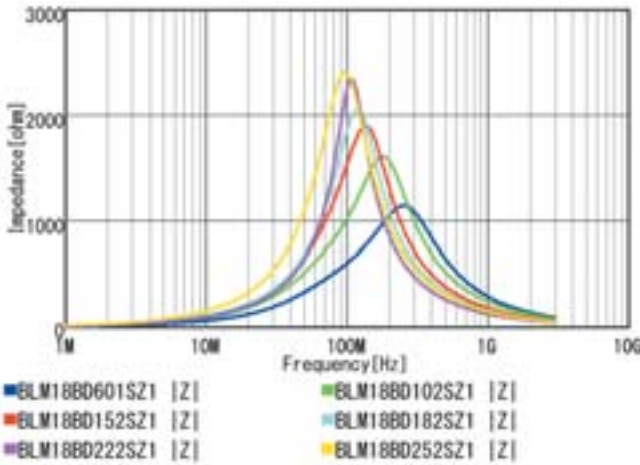

**Z-f characteristics: BLM18BD\_SH1 series**

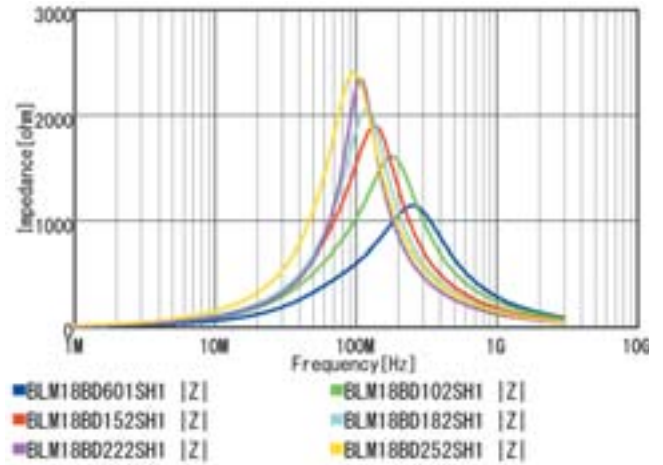

**BLM18BA050SZ1/BLM18BA050SH1**

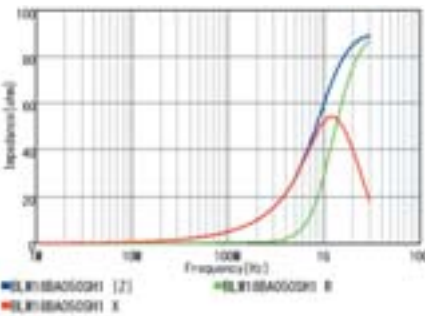

**BLM18BA100SZ1/BLM18BA100SH1**

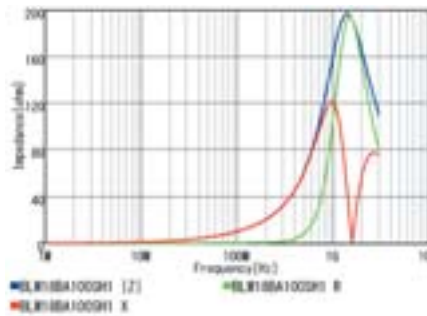

**BLM18BA220SZ1/BLM18BA220SH1**

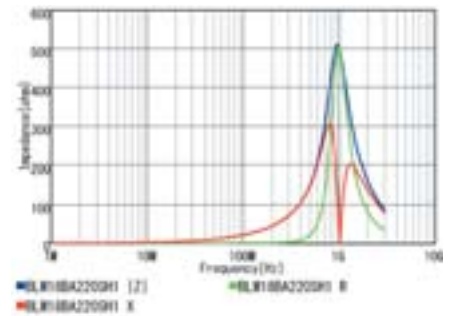

**BLM18BA470SZ1/BLM18BA470SH1**

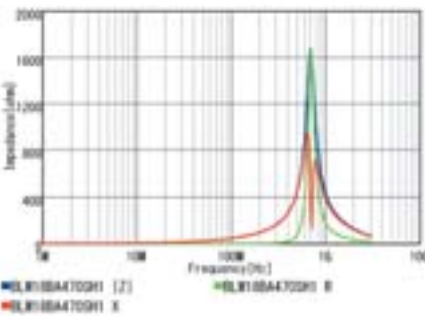

**BLM18BA750SZ1/BLM18BA750SH1**

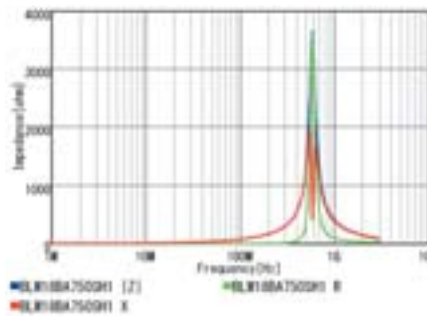

**BLM18BA121SZ1/BLM18BA121SH1**

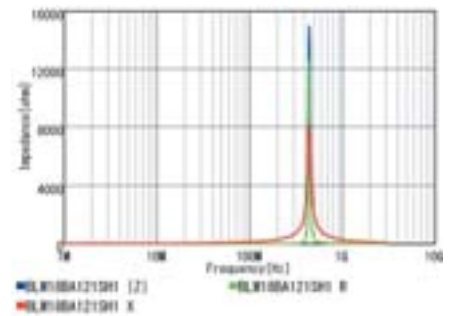

Continued on the following page. ↗

SMD Type  
 Chip Ferrite Bead  
 SMD Type  
 Chip EMIFIL®  
 SMD Type  
 Chip Common Mode Choke Coil  
 SMD Type  
 Block Type EMIFIL®  
 Lead Type  
 EMI Suppression Filters  
 SMD Type  
 Microchip Transformer (Balun)

Continued from the preceding page. ↘

## Z-f characteristics

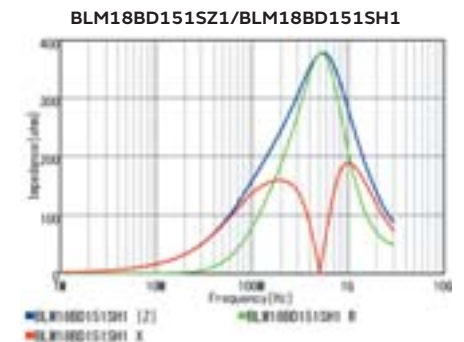
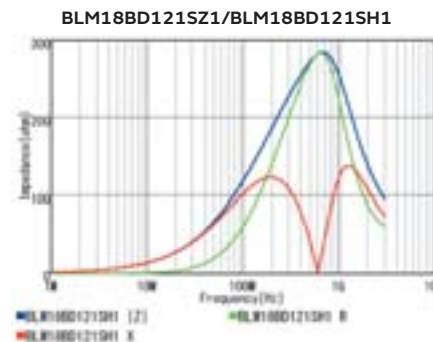
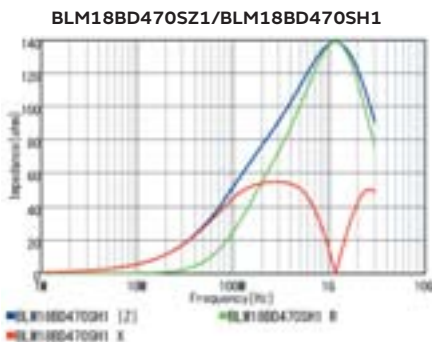
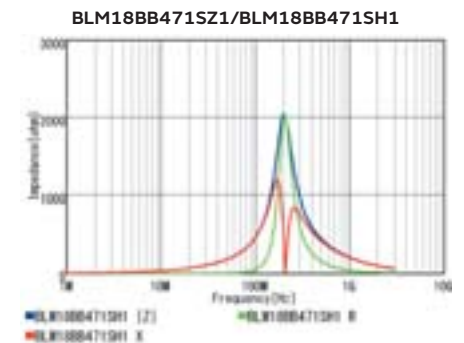
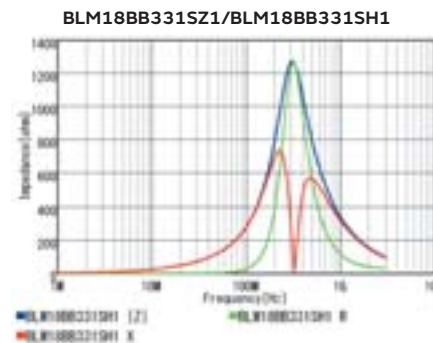
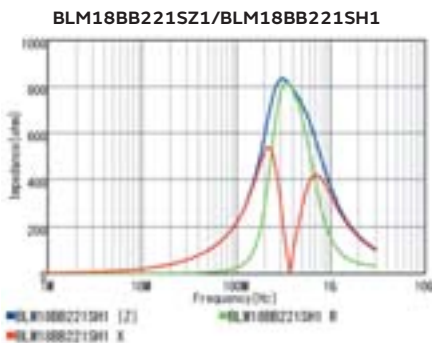
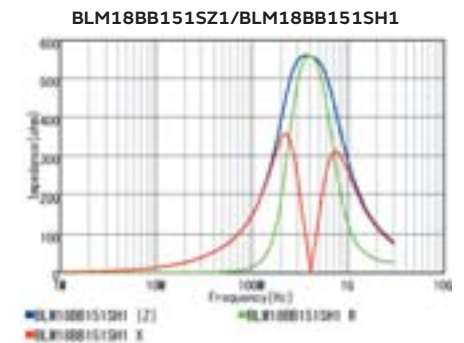
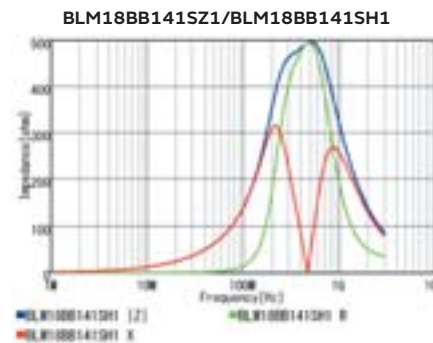
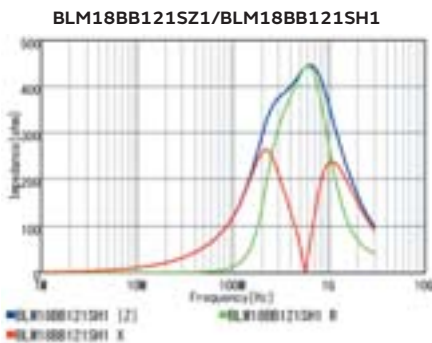
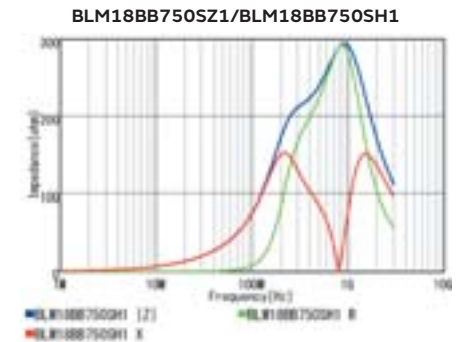
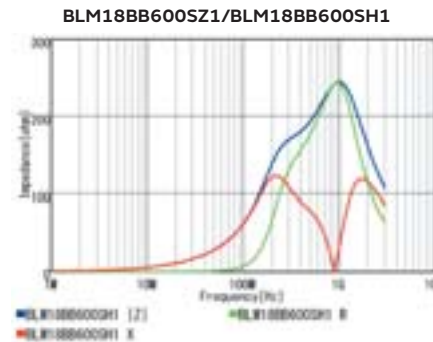
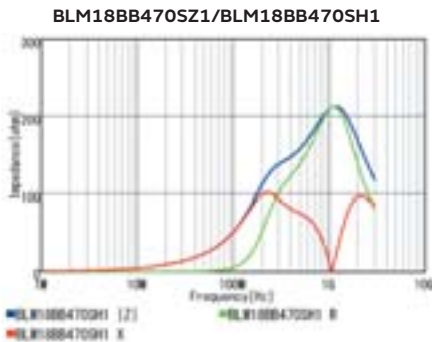
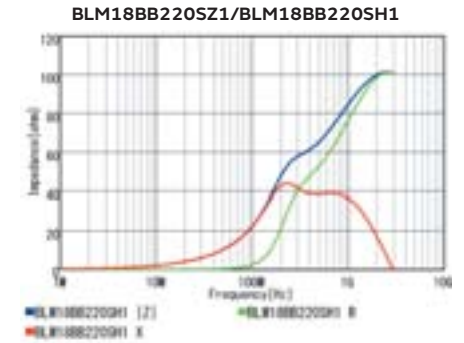
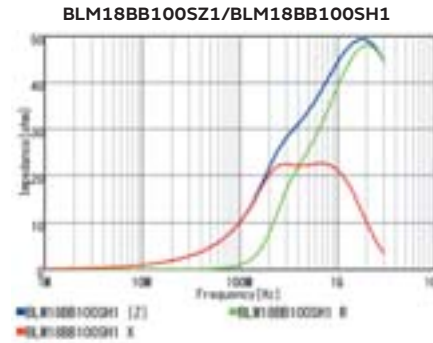
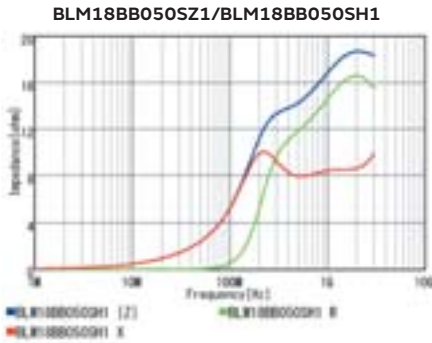

Chip Ferrite Bead SMD Type  
 Chip Common Mode Choke Coil SMD Type  
 Block Type EMIFIL® SMD Type  
 EMI Suppression Filters Lead Type  
 Microchip Transformer (Balun) SMD Type



Continued from the preceding page. ↘

**Z-f characteristics**

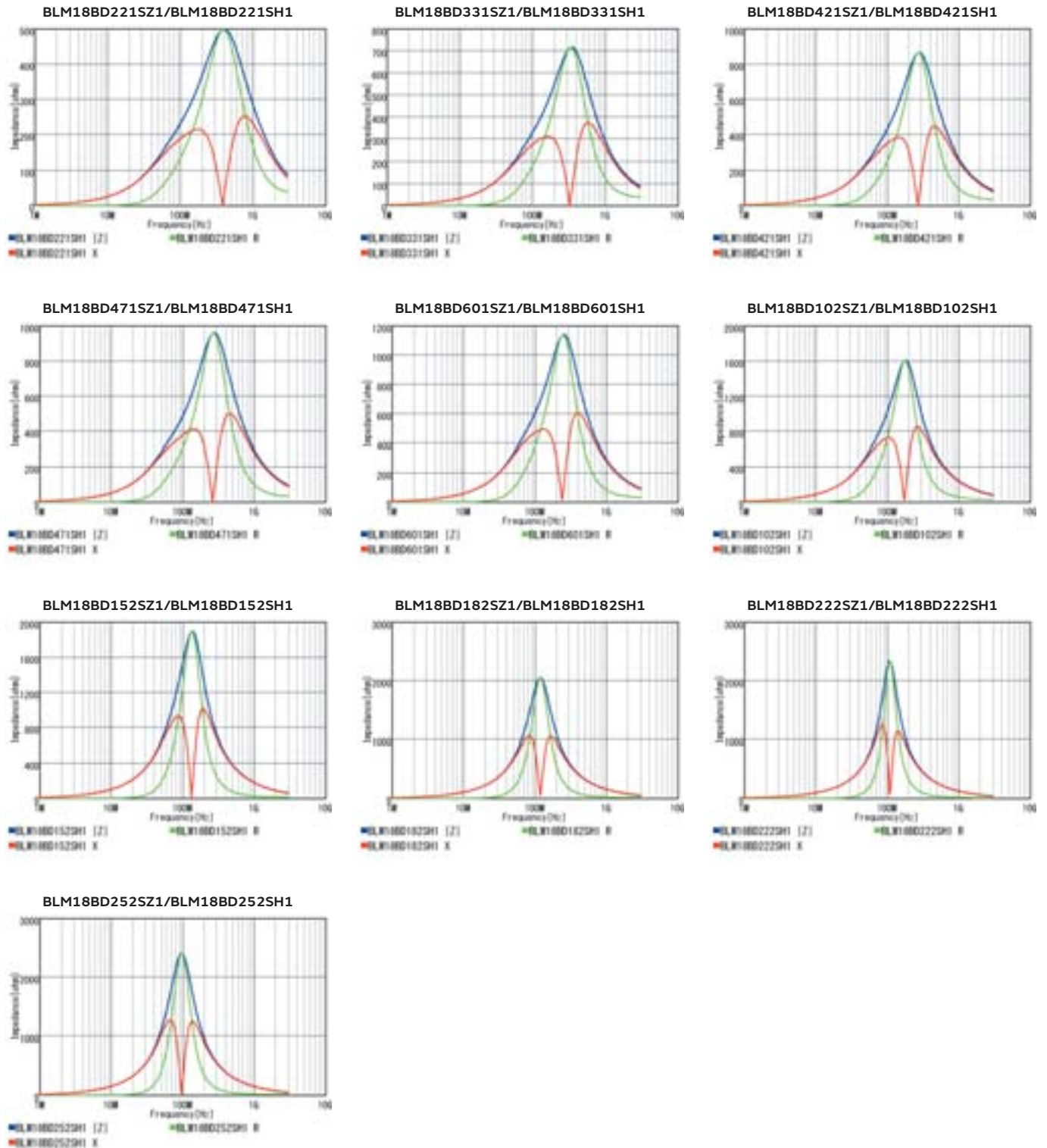

SMD Type  
 Chip Ferrite Bead

SMD Type  
 Chip EMI FIL®

SMD Type  
 Chip Common Mode Choke Coil

SMD Type  
 Block Type EMI FIL®

Lead Type  
 EMI Suppression Filters

SMD Type  
 Microchip Transformer (Balun)

# Chip Ferrite Bead SMD Type

## BLM18BD(150°C available) Series 0603/1608(inch/mm)

### Appearance/Dimensions

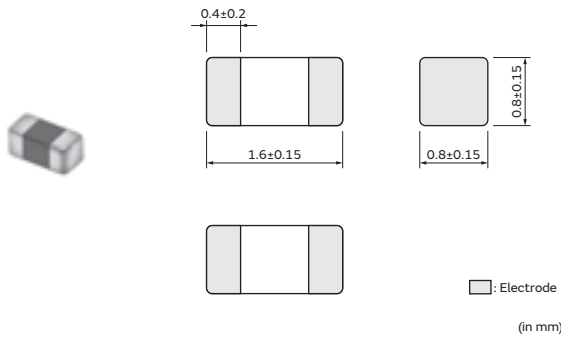

### Packaging

Code	Packaging	Minimum Quantity
D	ø180mm Paper Tape	4000
B	Bulk(Bag)	1000

### Equivalent Circuit

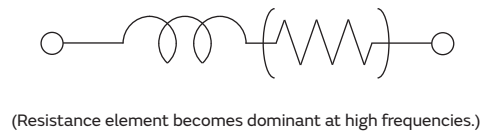

### Rated Value (□: packaging code)

Part Number		Impedance at 100MHz	Rated Current at 85°C	Rated Current at 125°C	DC Resistance (Max.)
Infotainment	Powertrain/Safety				
—	BLM18BD470BH1□	47Ω±25%	500mA	500mA	0.3Ω
—	BLM18BD121BH1□	120Ω±25%	300mA	300mA	0.4Ω
—	BLM18BD151BH1□	150Ω±25%	300mA	300mA	0.4Ω
—	BLM18BD221BH1□	220Ω±25%	250mA	250mA	0.45Ω
—	BLM18BD331BH1□	330Ω±25%	250mA	250mA	0.5Ω
—	BLM18BD421BH1□	420Ω±25%	250mA	250mA	0.55Ω
—	BLM18BD471BH1□	470Ω±25%	250mA	250mA	0.55Ω
—	BLM18BD601BH1□	600Ω±25%	200mA	200mA	0.65Ω
—	BLM18BD102BH1□	1000Ω±25%	200mA	200mA	0.85Ω
—	BLM18BD152BH1□	1500Ω±25%	150mA	150mA	1.2Ω
—	BLM18BD182BH1□	1800Ω±25%	150mA	150mA	1.5Ω
—	BLM18BD222BH1□	2200Ω±25%	150mA	150mA	1.5Ω
—	BLM18BD252BH1□	2500Ω±25%	150mA	150mA	1.5Ω

Rated Current at 150°C: 10mA  
 Operating Temp. Range: -55°C to 150°C

### Z-f characteristics: BLM18BD\_BH1 series

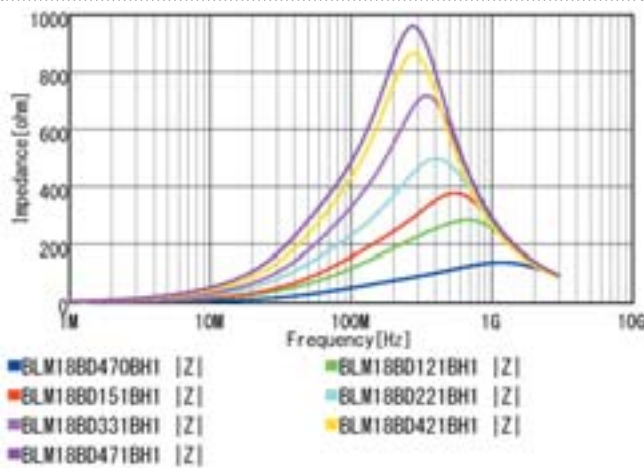

### Z-f characteristics: BLM18BD\_BH1 series

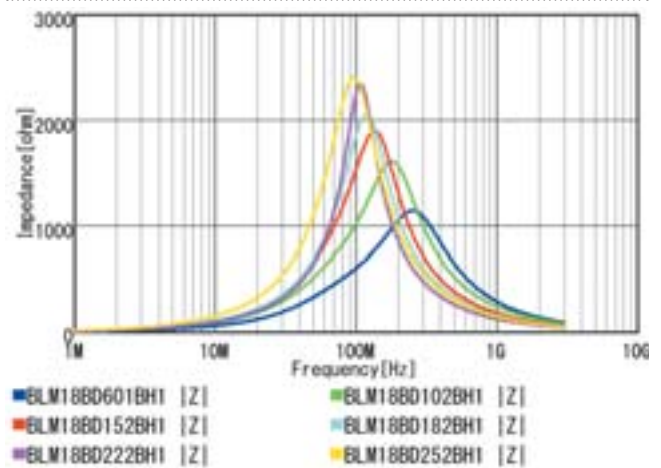

Continued on the following page. ↗

Continued from the preceding page. ↘

**Z-f characteristics**

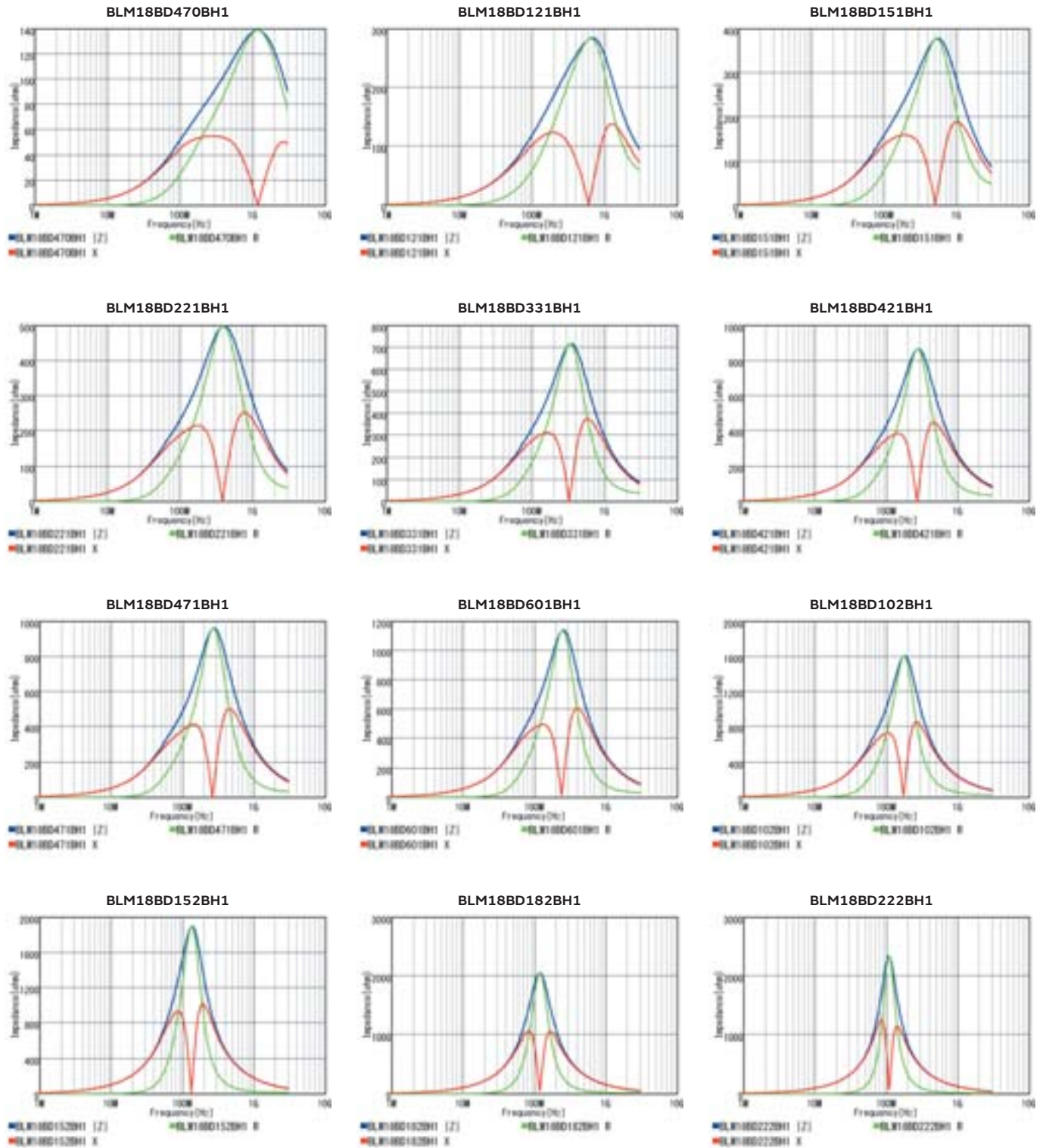

Continued on the following page. ↗

SMD Type  
 Chip Ferrite Bead  
 SMD Type  
 Chip EMIFIL®  
 SMD Type  
 Chip Common Mode Choke Coil  
 SMD Type  
 Block Type EMIFIL®  
 Lead Type  
 EMI Suppression Filters  
 SMD Type  
 Microchip Transformer (Balun)

Continued from the preceding page. ↘

## Z-f characteristics

BLM18BD252BH1

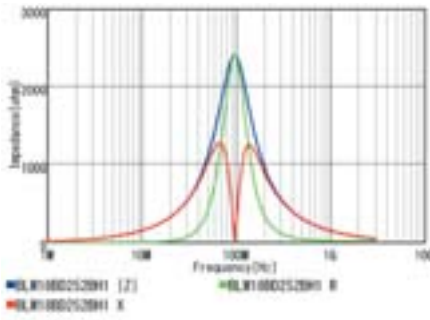

## Derating of Rated Current

In operating temperature exceeding +125°C, derating of current is necessary for BLM18BD\_BH1 series. Please apply the derating curve shown in chart according to the operating temperature.

Derating of Rated Current

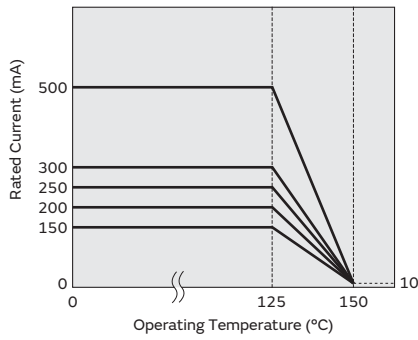

Chip Ferrite Bead  
 SMD Type

Chip EMIFIL®  
 SMD Type

Chip Common Mode Choke Coil  
 SMD Type

Block Type EMIFIL®  
 SMD Type

EMI Suppression Filters  
 Lead Type

Microchip Transformer (Balun)  
 SMD Type

# Chip Ferrite Bead SMD Type

## BLM18HB/HD/HE/HG Series 0603/1608(inch/mm)

### Appearance/Dimensions

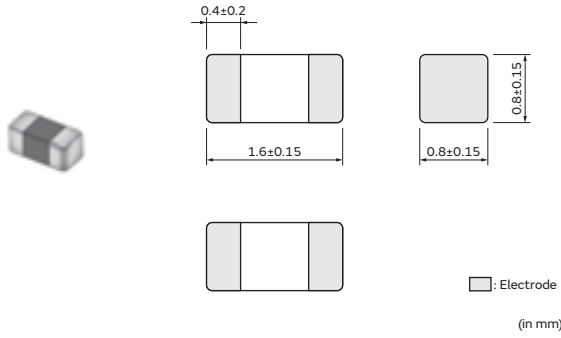

### Packaging

Code	Packaging	Minimum Quantity
D	ø180mm Paper Tape	4000
J	ø330mm Paper Tape	10000
B	Bulk(Bag)	1000

### Equivalent Circuit



(Resistance element becomes dominant at high frequencies.)

### Rated Value (□: packaging code)

Part Number		Impedance at 100MHz	Impedance at 1GHz	Rated Current at 85°C	Rated Current at 125°C	DC Resistance (Max.)
Infotainment	Powertrain/Safety					
BLM18HB121SZ1□	—	120Ω±25%	500Ω±40%	200mA	200mA	0.5Ω
BLM18HB221SZ1□	—	220Ω±25%	1100Ω±40%	100mA	100mA	0.8Ω
BLM18HB331SZ1□	—	330Ω±25%	1600Ω±40%	50mA	50mA	1.2Ω
BLM18HD471SZ1□	BLM18HD471SH1□	470Ω±25%	1000Ω(Typ.)	100mA	100mA	1.2Ω
BLM18HD601SZ1□	BLM18HD601SH1□	600Ω±25%	1200Ω(Typ.)	100mA	100mA	1.5Ω
BLM18HD102SZ1□	BLM18HD102SH1□	1000Ω±25%	1700Ω(Typ.)	50mA	50mA	1.8Ω
BLM18HE601SZ1□	BLM18HE601SH1□	600Ω±25%	600Ω(Typ.)	800mA	600mA	0.25Ω
BLM18HE102SZ1□	BLM18HE102SH1□	1000Ω±25%	1000Ω(Typ.)	600mA	500mA	0.35Ω
BLM18HE152SZ1□	BLM18HE152SH1□	1500Ω±25%	1500Ω(Typ.)	500mA	400mA	0.5Ω
BLM18HG471SZ1□	BLM18HG471SH1□	470Ω±25%	600Ω(Typ.)	200mA	200mA	0.85Ω
BLM18HG601SZ1□	BLM18HG601SH1□	600Ω±25%	700Ω(Typ.)	200mA	200mA	1Ω
BLM18HG102SZ1□	BLM18HG102SH1□	1000Ω±25%	1000Ω(Typ.)	100mA	100mA	1.6Ω

Operating Temp. Range: -55°C to 125°C

### Z-f characteristics: BLM18HB\_SZ1 series

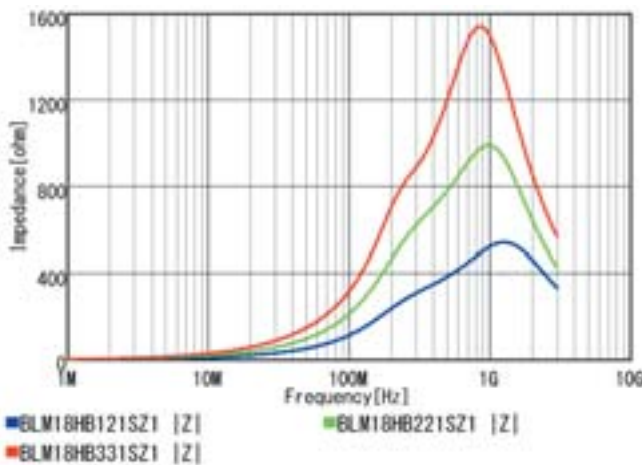

### Z-f characteristics: BLM18HD\_SZ1 series

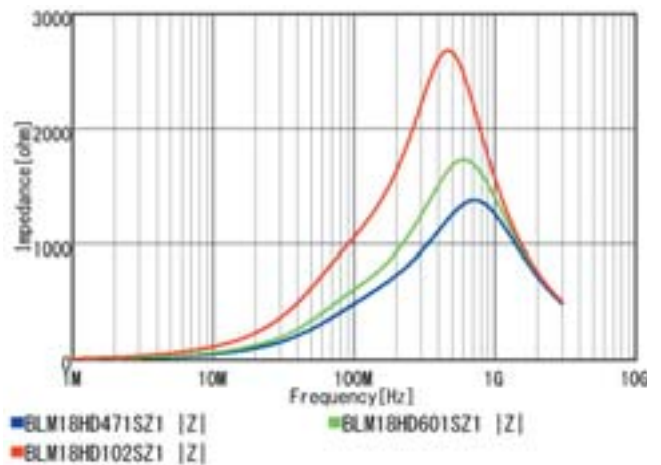

Continued on the following page. ↗

SMD Type  
 Chip Ferrite Bead

SMD Type  
 Chip EMIFIL®

SMD Type  
 Chip Common Mode Choke Coil

SMD Type  
 Block Type EMIFIL®

Lead Type  
 EMI Suppression Filters

SMD Type  
 Microchip Transformer (Balun)

Continued from the preceding page. ↘

**Z-f characteristics: BLM18HD\_SH1 series**

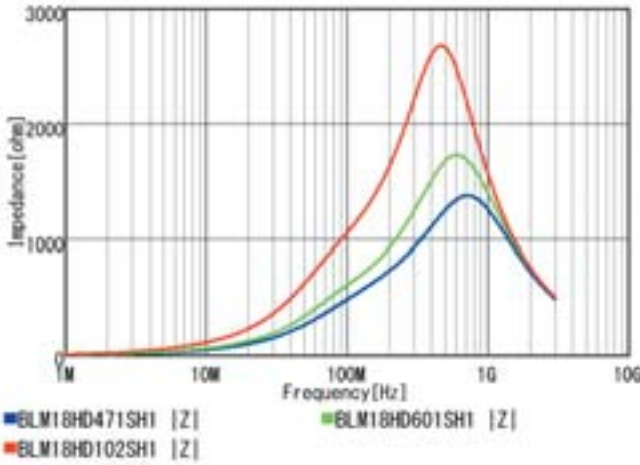

**Z-f characteristics: BLM18HE\_SZ1 series**

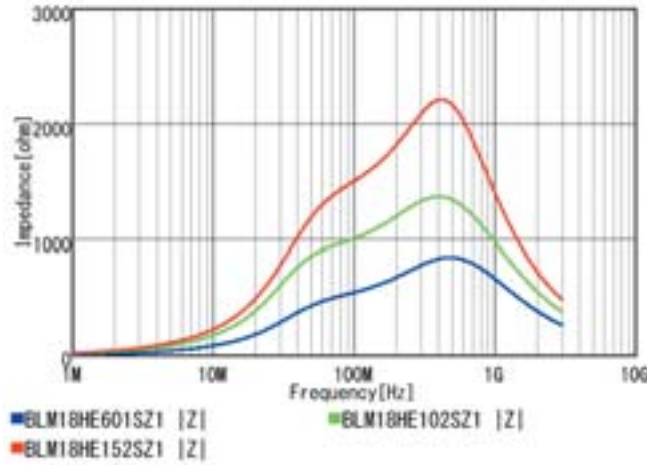

**Z-f characteristics: BLM18HE\_SH1 series**

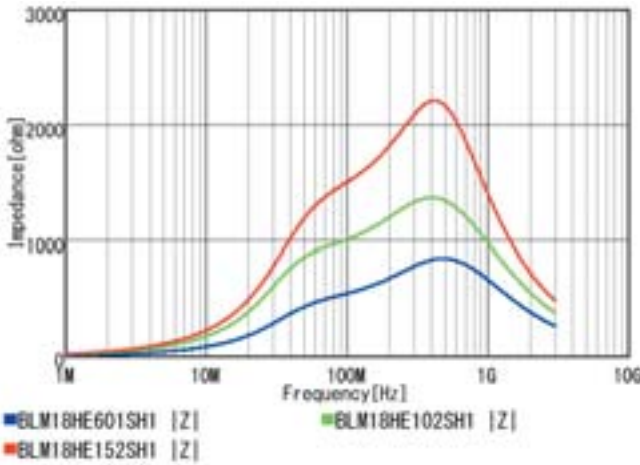

**Z-f characteristics: BLM18HG\_SZ1 series**

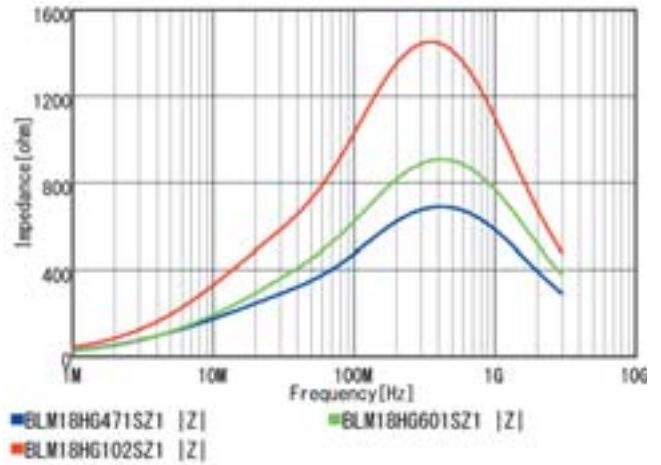

**Z-f characteristics: BLM18HG\_SH1 series**

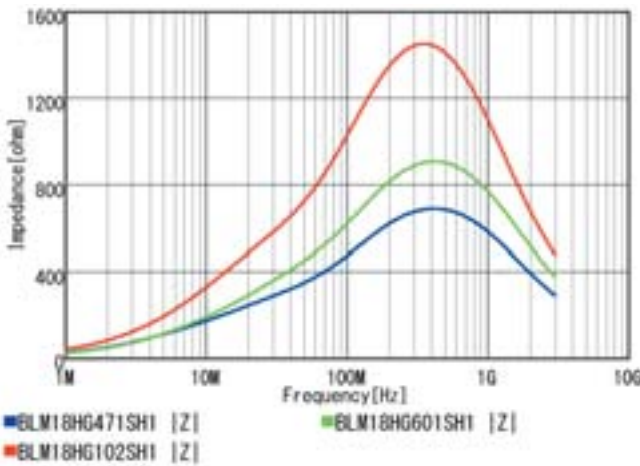

Continued on the following page. ↗

Chip Ferrite Bead  
SMD Type

Chip EMIFIL®  
SMD Type

Chip Common Mode Choke Coil  
SMD Type

Block Type EMIFIL®  
SMD Type

EMI Suppression Filters  
Lead Type

Microchip Transformer (Balun)  
SMD Type

Continued from the preceding page. ↘

**Z-f characteristics**

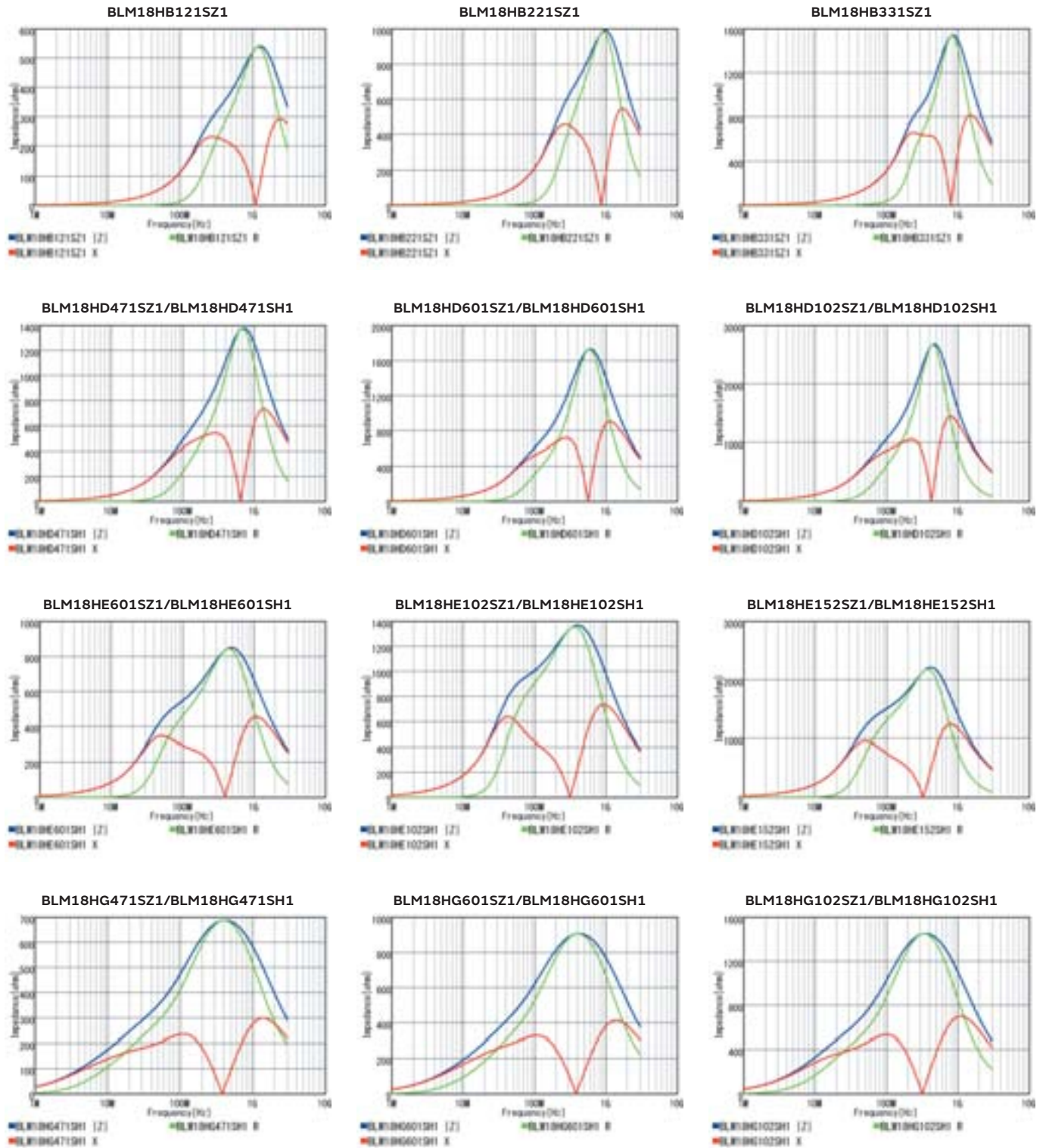

Continued on the following page. ↗

SMD Type  
 Chip Ferrite Bead  
 SMD Type  
 Chip EMIFIL®  
 SMD Type  
 Chip Common Mode Choke Coil  
 SMD Type  
 Block Type EMIFIL®  
 Lead Type  
 EMI Suppression Filters  
 SMD Type  
 Microchip Transformer (Balun)

Continued from the preceding page. ↘

## Derating of Rated Current

In operating temperature exceeding +85°C, derating of current is necessary for BLM18HE series.  
Please apply the derating curve shown in chart according to the operating temperature.

Derating of Rated Current

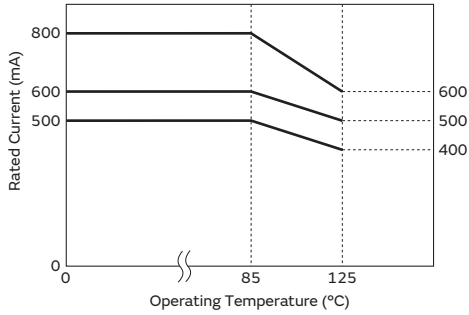

Chip Ferrite Bead  
SMD Type

Chip EMIFIL®  
SMD Type

Chip Common Mode Choke Coil  
SMD Type

Block Type EMIFIL®  
SMD Type

EMI Suppression Filters  
Lead Type

Microchip Transformer (Balun)  
SMD Type



# Chip Ferrite Bead SMD Type

## BLM18EG Series 0603/1608(inch/mm)

### Appearance/Dimensions

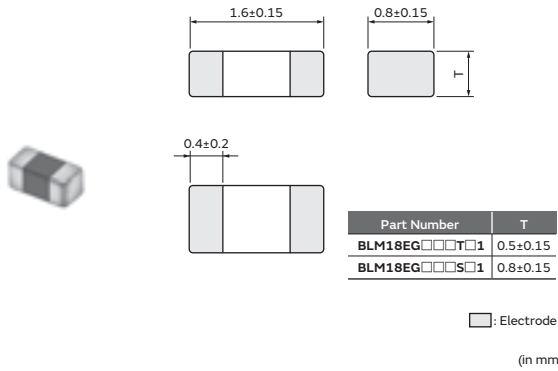

### Packaging

Code	Packaging	Minimum Quantity
D	ø180mm Paper Tape	4000
J	ø330mm Paper Tape	10000
B	Bulk(Bag)	1000

### Equivalent Circuit



(Resistance element becomes dominant at high frequencies.)

### Rated Value (□: packaging code)

Part Number		Impedance at 100MHz	Impedance at 1GHz	Rated Current at 85°C	Rated Current at 125°C	DC Resistance (Max.)
Infotainment	Powertrain/Safety					
BLM18EG121SZ1□	BLM18EG121SH1□	120Ω±25%	145Ω(Typ.)	2A	1A	0.04Ω
—	BLM18EG181SH1□	180Ω±25%	240Ω(Typ.)	2A	1A	0.05Ω
BLM18EG221SZ1□	—	220Ω±25%	260Ω(Typ.)	2A	1A	0.05Ω
BLM18EG471SZ1□	BLM18EG471SH1□	470Ω±25%	550Ω(Typ.)	500mA	500mA	0.21Ω
BLM18EG601SZ1□	BLM18EG601SH1□	600Ω±25%	700Ω(Typ.)	500mA	500mA	0.35Ω
BLM18EG101TZ1□	BLM18EG101TH1□	100Ω±25%	140Ω(Typ.)	2A	1A	0.045Ω
BLM18EG221TZ1□	BLM18EG221TH1□	220Ω±25%	300Ω(Typ.)	1A	1A	0.15Ω
BLM18EG331TZ1□	BLM18EG331TH1□	330Ω±25%	450Ω(Typ.)	500mA	500mA	0.21Ω
BLM18EG391TZ1□	BLM18EG391TH1□	390Ω±25%	520Ω(Typ.)	500mA	500mA	0.3Ω

Operating Temp. Range: -55°C to 125°C

### Z-f characteristics: BLM18EG\_SZ1 series

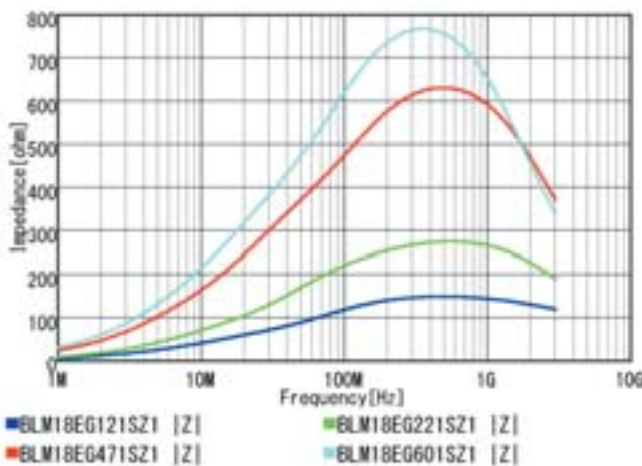

### Z-f characteristics: BLM18EG\_SH1 series

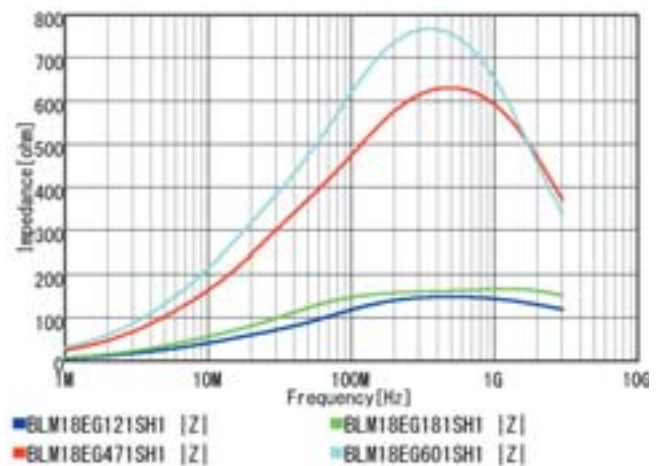

Continued on the following page. ↗

Continued from the preceding page. ↘

**Z-f characteristics: BLM18EG\_TZ1 series**

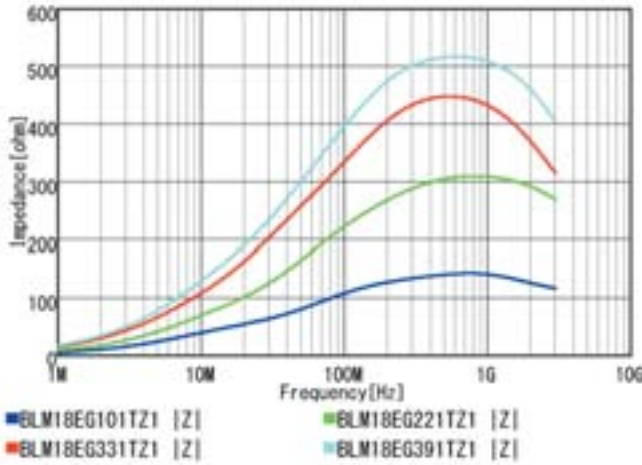

**Z-f characteristics: BLM18EG\_TH1 series**

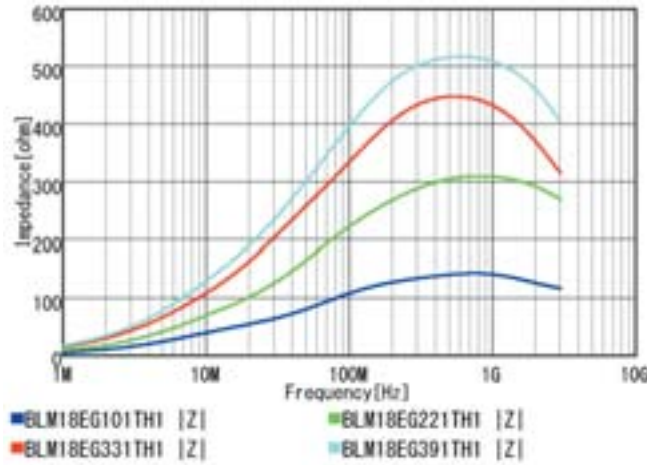

**BLM18EG121SZ1/BLM18EG121SH1**

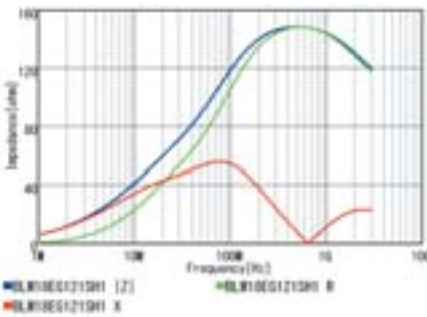

**BLM18EG181SH1**

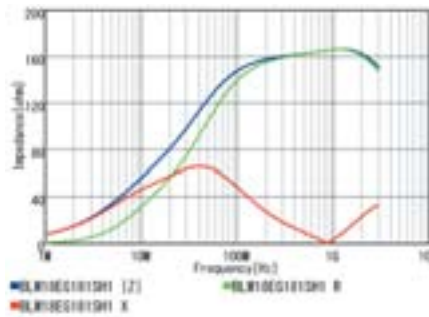

**BLM18EG221SZ1**

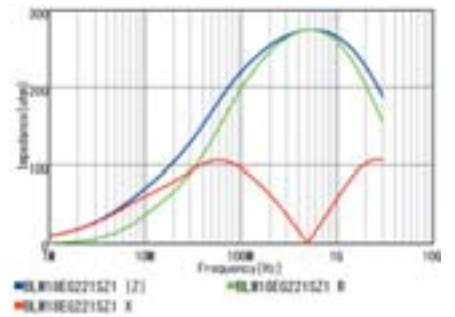

**BLM18EG471SZ1/BLM18EG471SH1**

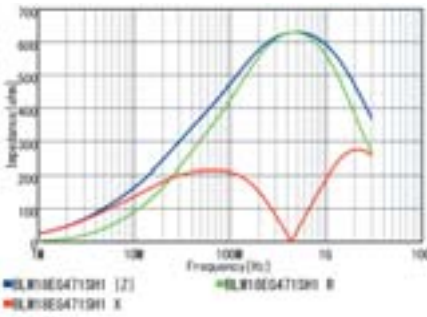

**BLM18EG601SZ1/BLM18EG601SH1**

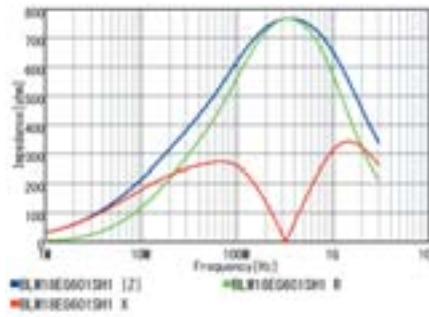

**BLM18EG101TZ1/BLM18EG101TH1**

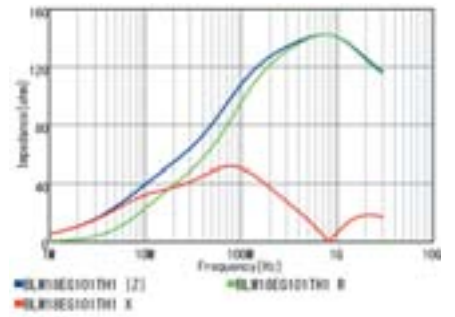

**BLM18EG221TZ1/BLM18EG221TH1**

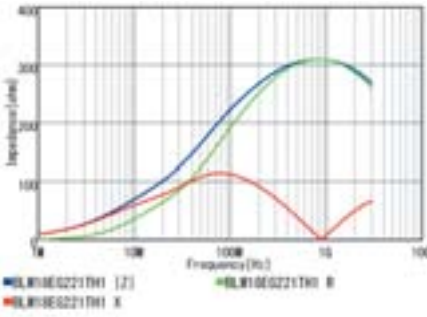

**BLM18EG331TZ1/BLM18EG331TH1**

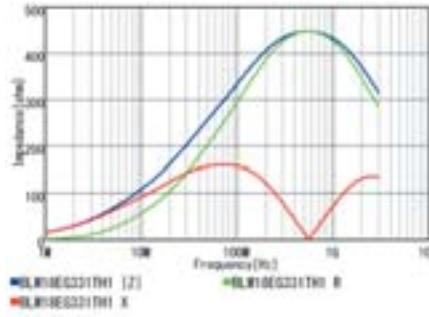

**BLM18EG391TZ1/BLM18EG391TH1**

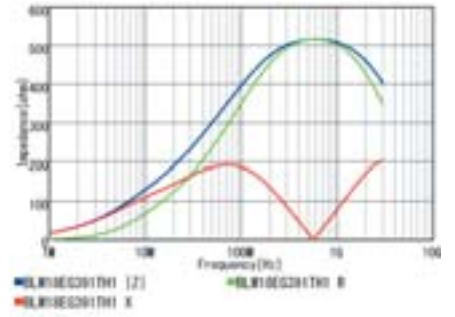

Continued on the following page. ↗

Chip Ferrite Bead SMD Type  
 Chip Common Mode Choke Coil SMD Type  
 Block Type EMI FIL® SMD Type  
 EMI Suppression Filters Lead Type  
 Microchip Transformer (Balun) SMD Type

Continued from the preceding page. ↘

## Derating of Rated Current

In operating temperature exceeding +85°C, derating of current is necessary for BLM18EG series. Please apply the derating curve shown in chart according to the operating temperature.

Derating of Rated Current

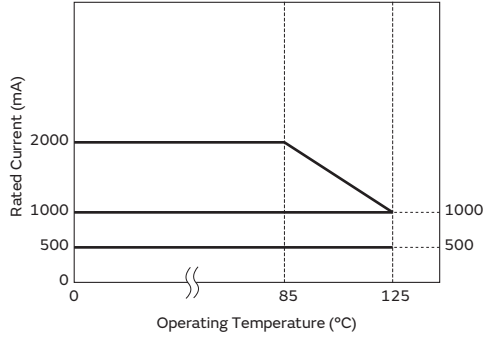

# Chip Ferrite Bead SMD Type

## BLM18G Series 0603/1608(inch/mm)

### Appearance/Dimensions

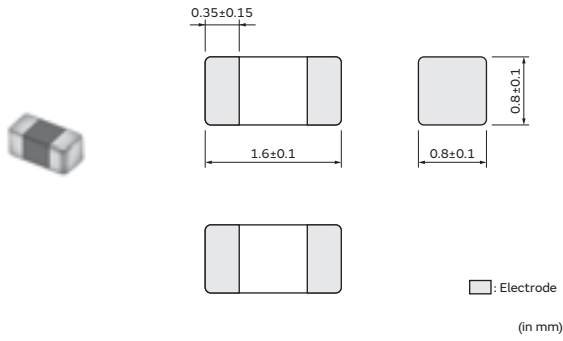

### Packaging

Code	Packaging	Minimum Quantity
D	ø180mm Paper Tape	4000
J	ø330mm Paper Tape	10000
B	Bulk(Bag)	1000

### Equivalent Circuit



(Resistance element becomes dominant at high frequencies.)

### Rated Value (□: packaging code)

Part Number		Impedance at 100MHz	Impedance at 1GHz	Rated Current at 85°C	Rated Current at 125°C	DC Resistance (Max.)	Operating Temp. Range
Infotainment	Powertrain/Safety						
BLM18GG471SZ1□	—	470Ω±25%	1800Ω±30%	200mA	200mA	1.3Ω	-55°C to 125°C

### Z-f characteristics

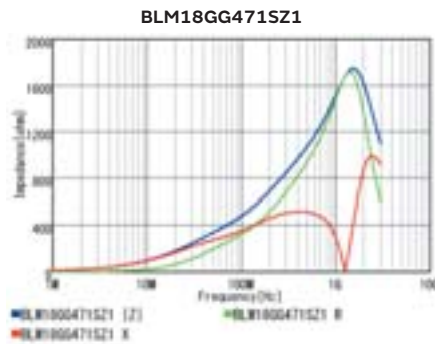

# Chip Ferrite Bead SMD Type

## BLM21PG Series 0805/2012(inch/mm)

### Appearance/Dimensions

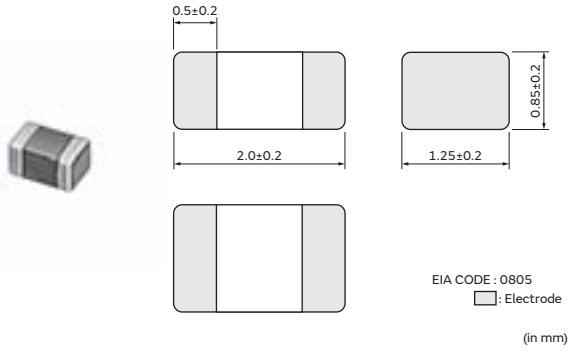

### Packaging

Code	Packaging	Minimum Quantity
D	ø180mm Paper Tape	4000
J	ø330mm Paper Tape	10000
B	Bulk(Bag)	1000

### Equivalent Circuit



(Resistance element becomes dominant at high frequencies.)

### Rated Value (□: packaging code)

Part Number		Impedance at 100MHz	Rated Current at 85°C	Rated Current at 125°C	DC Resistance (Max.)
Infotainment	Powertrain/Safety				
BLM21PG220SZ1□	BLM21PG220SH1□	22Ω±25%	6A	3.3A	0.009Ω
BLM21PG300SZ1□	BLM21PG300SH1□	30Ω(Typ.)	4A	2.3A	0.014Ω
BLM21PG600SZ1□	BLM21PG600SH1□	60Ω±25%	3.5A	1.9A	0.02Ω
BLM21PG121SZ1□	BLM21PG121SH1□	120Ω±25%	3A	1.55A	0.03Ω
BLM21PG221SZ1□	BLM21PG221SH1□	220Ω±25%	2A	1.25A	0.045Ω
BLM21PG331SZ1□	BLM21PG331SH1□	330Ω±25%	1.5A	1A	0.07Ω

Operating Temp. Range: -55°C to 125°C

### Z-f characteristics: BLM21PG\_SZ1 series

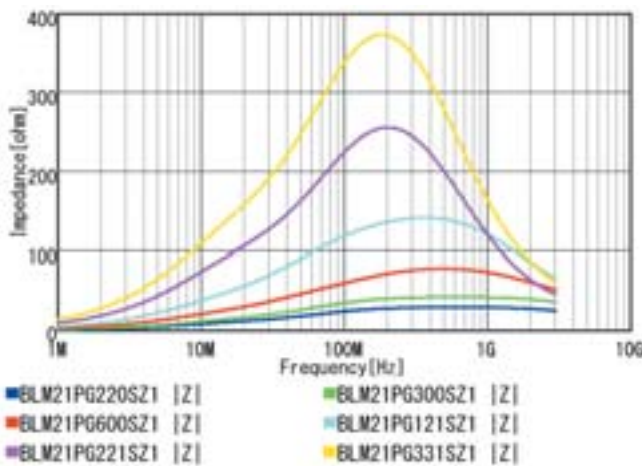

### Z-f characteristics: BLM21PG\_SH1 series

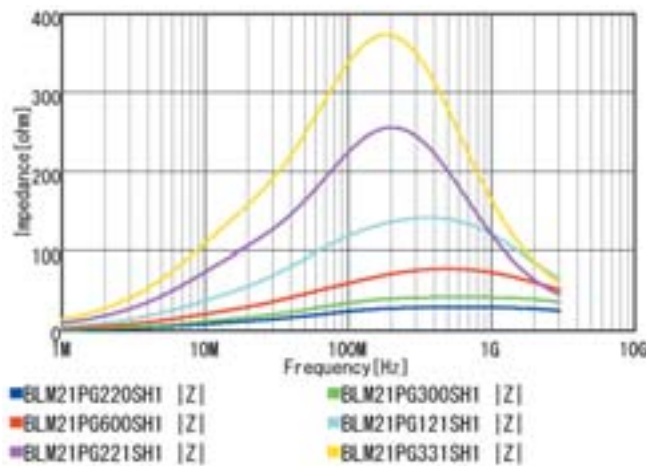

Continued on the following page. ↗

Continued from the preceding page. ↘

## Z-f characteristics

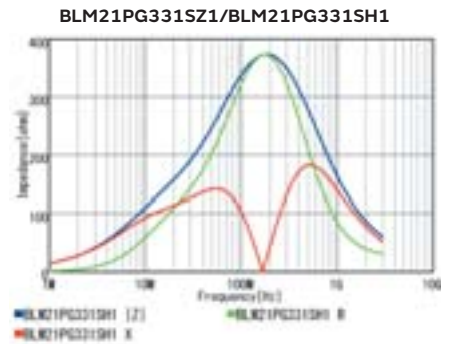
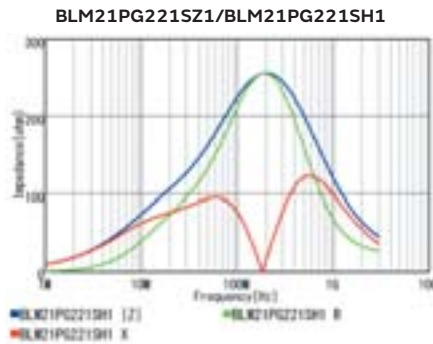
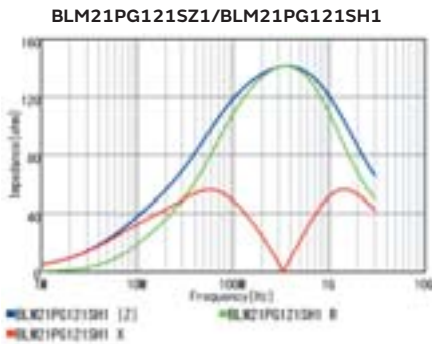
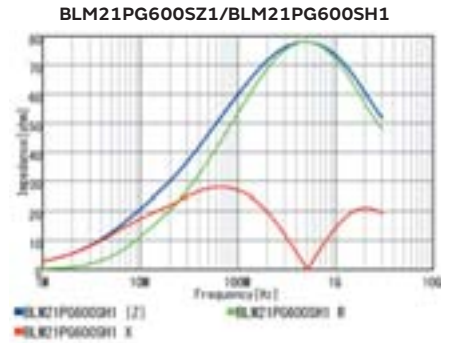
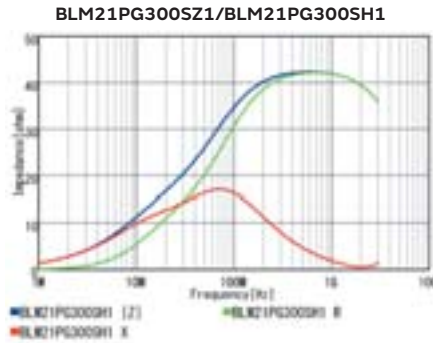
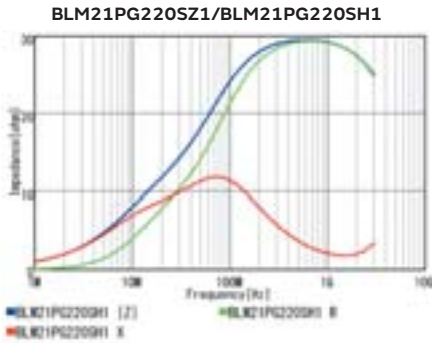

## Derating of Rated Current

In operating temperature exceeding +85°C, derating of current is necessary for BLM21PG series.  
 Please apply the derating curve shown in chart according to the operating temperature.

Derating of Rated Current

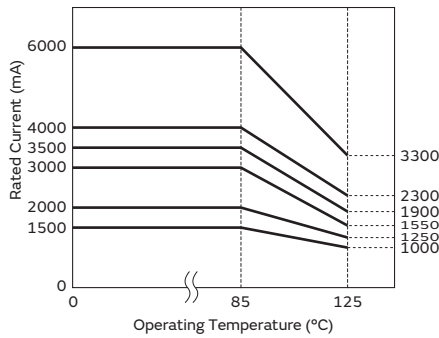

Chip Ferrite Bead  
 SMD Type

Chip EMIFIL®  
 SMD Type

Chip Common Mode Choke Coil  
 SMD Type

Block Type EMIFIL®  
 SMD Type

EMI Suppression Filters  
 Lead Type

Microchip Transformer (Balun)  
 SMD Type

# Chip Ferrite Bead SMD Type

## BLM21PG(150°C available) Series 0805/2012(inch/mm)

### Appearance/Dimensions

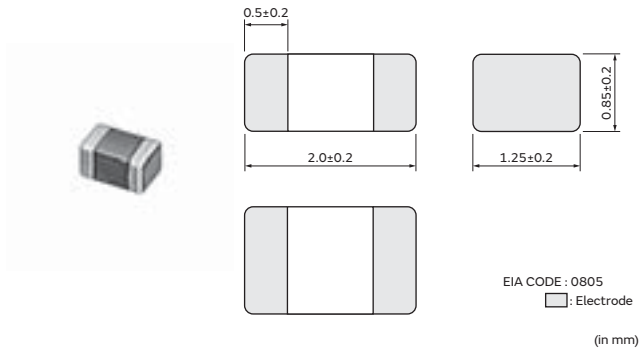

### Packaging

Code	Packaging	Minimum Quantity
D	ø180mm Paper Tape	4000
J	ø330mm Paper Tape	10000
B	Bulk(Bag)	1000

### Equivalent Circuit



(Resistance element becomes dominant at high frequencies.)

### Rated Value (□: packaging code)

Part Number		Impedance at 100MHz	Rated Current at 85°C	Rated Current at 125°C	DC Resistance (Max.)
Infotainment	Powertrain/Safety				
—	BLM21PG220BH1□	22Ω±25%	3.3A	3.3A	0.009Ω
—	BLM21PG300BH1□	30Ω(Typ.)	2.3A	2.3A	0.014Ω
—	BLM21PG600BH1□	60Ω±25%	1.9A	1.9A	0.02Ω
—	BLM21PG121BH1□	120Ω±25%	1.55A	1.55A	0.03Ω
—	BLM21PG221BH1□	220Ω±25%	1.25A	1.25A	0.045Ω
—	BLM21PG331BH1□	330Ω±25%	1A	1A	0.07Ω

Rated Current at 150°C: 10mA  
 Operating Temp. Range: -55°C to 150°C

### Z-f characteristics: BLM21PG\_BH1 series

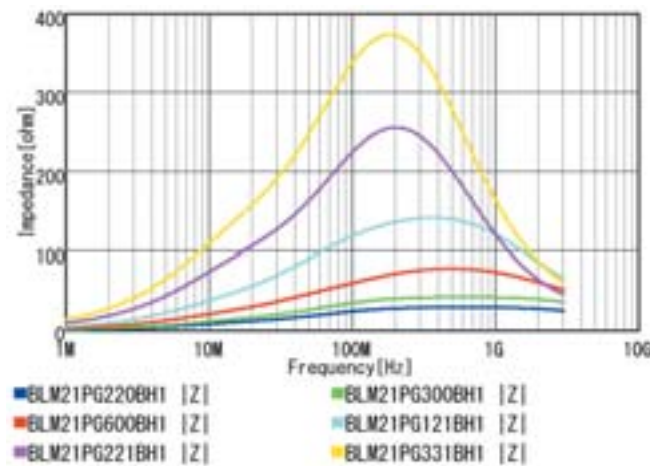

Continued on the following page. ↗

SMD Type  
 Chip Ferrite Bead

SMD Type  
 Chip EMIFIL®

SMD Type  
 Chip Common Mode Choke Coil

SMD Type  
 Block Type EMIFIL®

Lead Type  
 EMI Suppression Filters

SMD Type  
 Microchip Transformer (Balun)

Continued from the preceding page. ↘

## Z-f characteristics

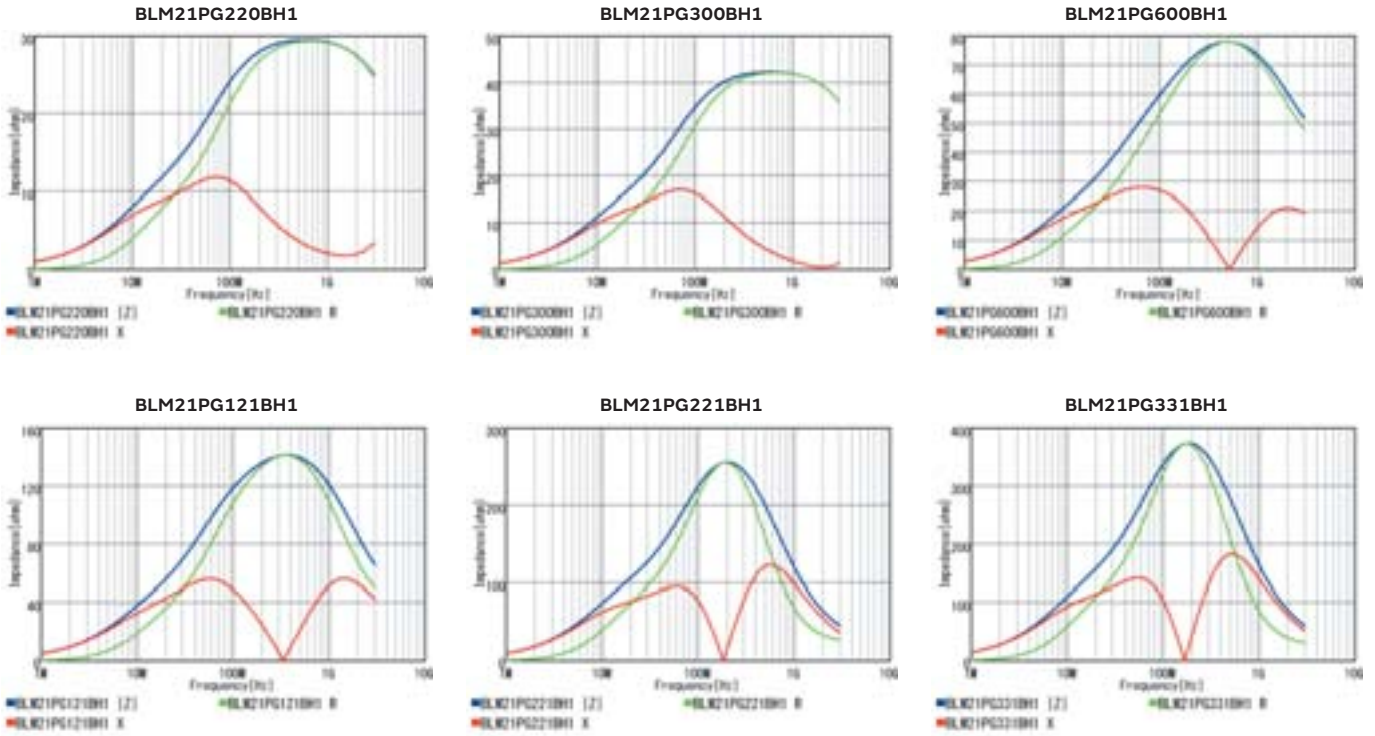

## Derating of Rated Current

In operating temperature exceeding +125°C, derating of current is necessary for BLM21PG\_BH1 series. Please apply the derating curve shown in chart according to the operating temperature.

Derating of Rated Current

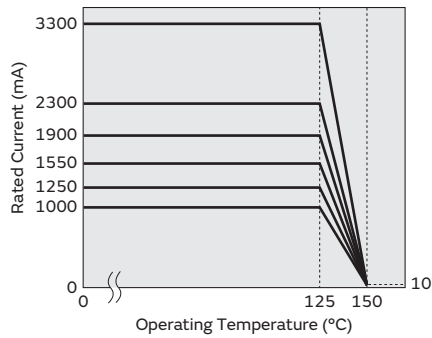



# Chip Ferrite Bead SMD Type

## BLM21SN Series 0805/2012(inch/mm)

### Appearance/Dimensions

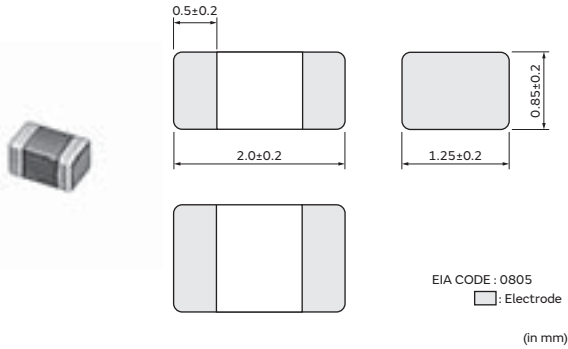

### Packaging

Code	Packaging	Minimum Quantity
D	ø180mm Paper Tape	4000
J	ø330mm Paper Tape	10000
B	Bulk(Bag)	1000

### Equivalent Circuit



(Resistance element becomes dominant at high frequencies.)

### Rated Value (□: packaging code)

Part Number		Impedance at 100MHz	Rated Current at 85°C	Rated Current at 125°C	DC Resistance (Max.)	Operating Temp. Range
Infotainment	Powertrain/Safety					
BLM21SN300SZ1□	BLM21SN300SH1□	30Ω±10Ω	8.5A	6A	0.004Ω	-55°C to 125°C

### Z-f characteristics

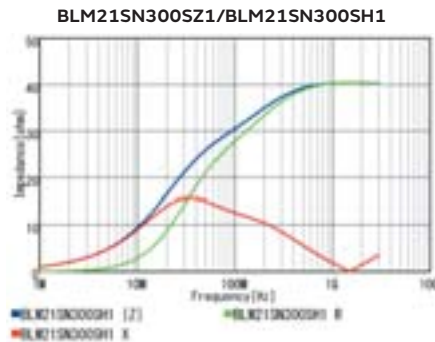

### Derating of Rated Current

In operating temperature exceeding +85°C, derating of current is necessary for BLM21SN series. Please apply the derating curve shown in chart according to the operating temperature.

Derating of Rated Current

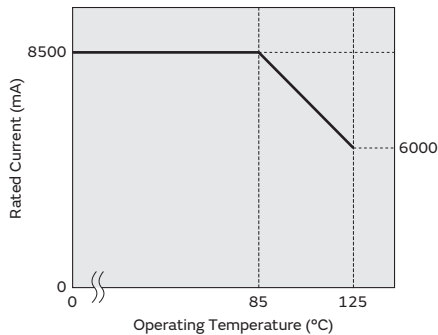

SMD Type  
 Chip Ferrite Bead

SMD Type  
 Chip EMIFIL®

SMD Type  
 Chip Common Mode Choke Coil

SMD Type  
 Block Type EMIFIL®

Lead Type  
 EMI Suppression Filters

SMD Type  
 Microchip Transformer (Balun)

# Chip Ferrite Bead SMD Type

## BLM21AG Series 0805/2012(inch/mm)

### Appearance/Dimensions

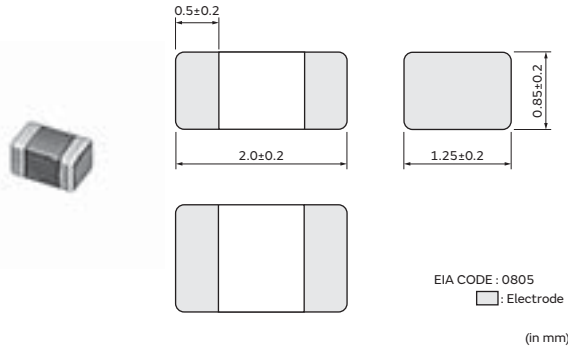

### Packaging

Code	Packaging	Minimum Quantity
D	ø180mm Paper Tape	4000
J	ø330mm Paper Tape	10000
B	Bulk(Bag)	1000

### Equivalent Circuit



(Resistance element becomes dominant at high frequencies.)

### Rated Value (□: packaging code)

Part Number		Impedance at 100MHz	Rated Current at 85°C	Rated Current at 125°C	DC Resistance (Max.)
Infotainment	Powertrain/Safety				
BLM21AG121SZ1□	BLM21AG121SH1□	120Ω±25%	1A	1A	0.09Ω
BLM21AG151SZ1□	BLM21AG151SH1□	150Ω±25%	1A	1A	0.09Ω
BLM21AG221SZ1□	BLM21AG221SH1□	220Ω±25%	900mA	900mA	0.12Ω
BLM21AG331SZ1□	BLM21AG331SH1□	330Ω±25%	800mA	800mA	0.15Ω
BLM21AG471SZ1□	BLM21AG471SH1□	470Ω±25%	700mA	700mA	0.18Ω
BLM21AG601SZ1□	BLM21AG601SH1□	600Ω±25%	700mA	700mA	0.2Ω
BLM21AG102SZ1□	BLM21AG102SH1□	1000Ω±25%	600mA	600mA	0.27Ω

Operating Temp. Range: -55°C to 125°C

### Z-f characteristics: BLM21AG\_SZ1 series

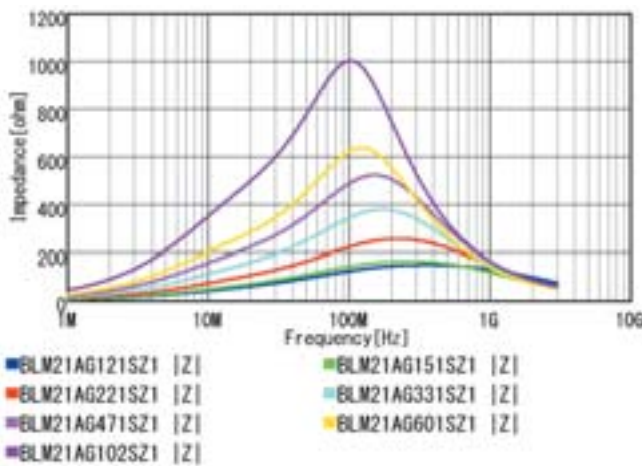

### Z-f characteristics: BLM21AG\_SH1 series

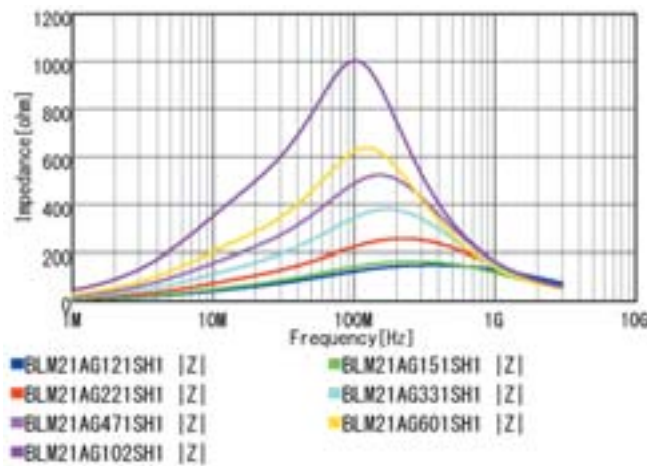

Continued on the following page. ↗

Continued from the preceding page. ↘

## Z-f characteristics

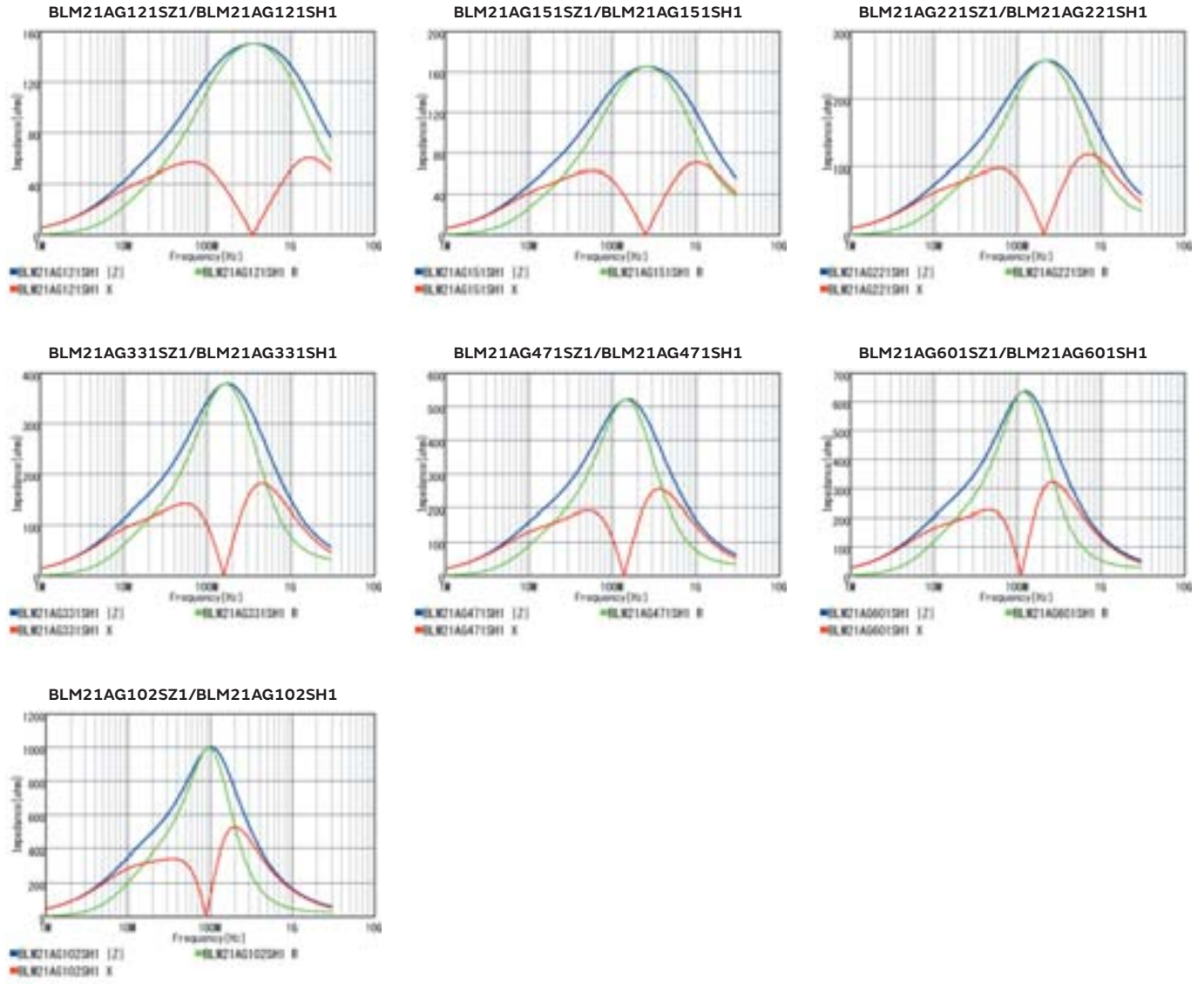

SMD Type  
 Chip Ferrite Bead

SMD Type  
 Chip EMIFIL®

SMD Type  
 Chip Common Mode Choke Coil

SMD Type  
 Block Type EMIFIL®

Lead Type  
 EMI Suppression Filters

SMD Type  
 Microchip Transformer (Balun)

## Chip Ferrite Bead SMD Type

# BLM21AG(150°C available) Series 0805/2012(inch/mm)

### Appearance/Dimensions

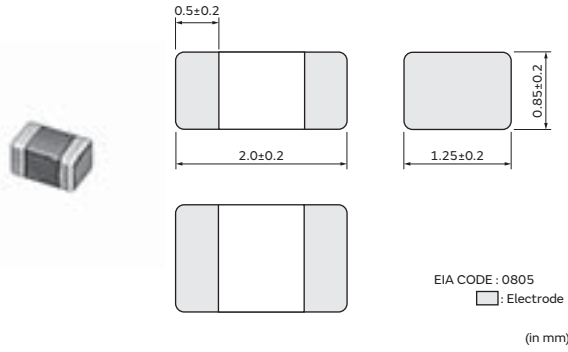

### Packaging

Code	Packaging	Minimum Quantity
D	ø180mm Paper Tape	4000
J	ø330mm Paper Tape	10000
B	Bulk(Bag)	1000

### Equivalent Circuit



(Resistance element becomes dominant at high frequencies.)

### Rated Value (□: packaging code)

Part Number		Impedance at 100MHz	Rated Current at 85°C	Rated Current at 125°C	DC Resistance (Max.)
Infotainment	Powertrain/Safety				
—	BLM21AG121BH1□	120Ω±25%	1A	1A	0.09Ω
—	BLM21AG151BH1□	150Ω±25%	1A	1A	0.09Ω
—	BLM21AG221BH1□	220Ω±25%	900mA	900mA	0.12Ω
—	BLM21AG331BH1□	330Ω±25%	800mA	800mA	0.15Ω
—	BLM21AG471BH1□	470Ω±25%	700mA	700mA	0.18Ω
—	BLM21AG601BH1□	600Ω±25%	700mA	700mA	0.2Ω
—	BLM21AG102BH1□	1000Ω±25%	600mA	600mA	0.27Ω

Rated Current at 150°C: 10mA  
 Operating Temp. Range: -55°C to 150°C

### Z-f characteristics: BLM21AG\_BH1 series

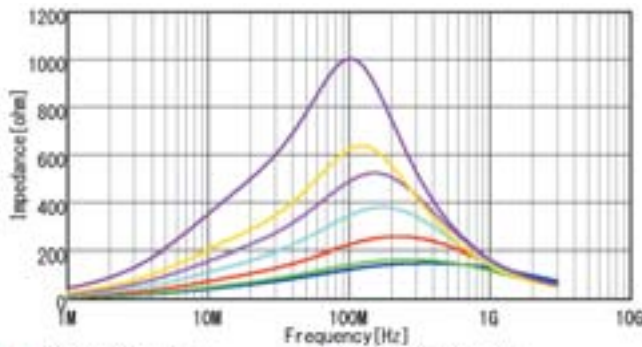

- BLM21AG121BH1 |Z|
- BLM21AG151BH1 |Z|
- BLM21AG221BH1 |Z|
- BLM21AG331BH1 |Z|
- BLM21AG471BH1 |Z|
- BLM21AG601BH1 |Z|
- BLM21AG102BH1 |Z|

Continued on the following page. ↗

Continued from the preceding page. ↘

## Z-f characteristics

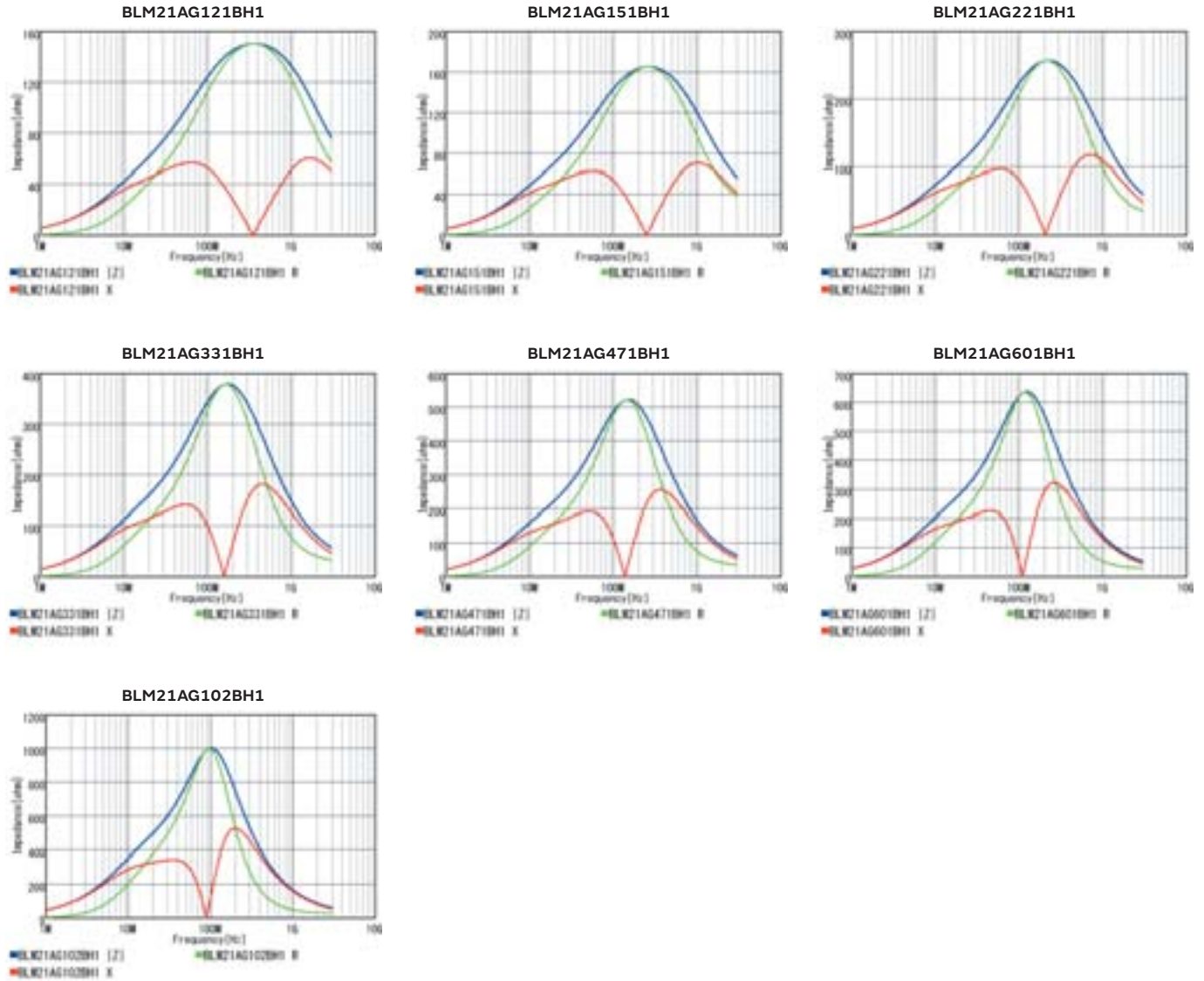

## Derating of Rated Current

In operating temperature exceeding +125°C, derating of current is necessary for BLM21AG\_BH1 series. Please apply the derating curve shown in chart according to the operating temperature.

Derating of Rated Current

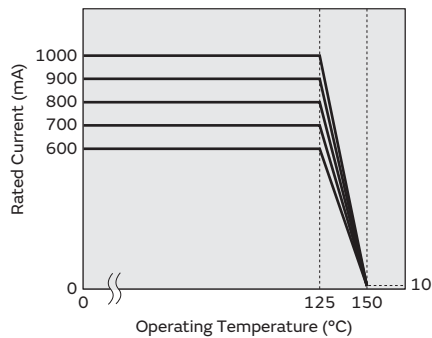

SMD Type  
 Chip Ferrite Bead

SMD Type  
 Chip EMIFIL®

SMD Type  
 Chip Common Mode Choke Coil

SMD Type  
 Block Type EMIFIL®

Lead Type  
 EMI Suppression Filters

SMD Type  
 Microchip Transformer (Balun)

# Chip Ferrite Bead SMD Type

## BLM21BB/BD Series 0805/2012(inch/mm)

### Appearance/Dimensions

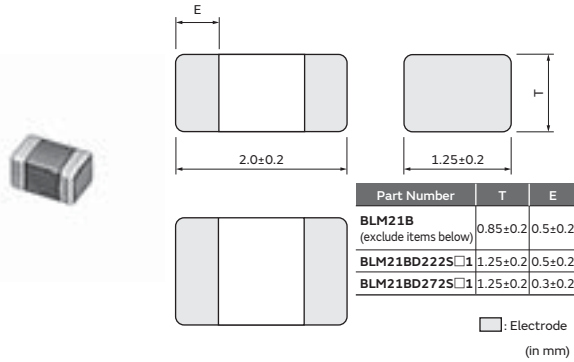

### Packaging

All except for BLM21BD222SZ1/BLM21BD222SH1/BLM21BD272SZ1/BLM21BD272SH1

Code	Packaging	Minimum Quantity
<b>D</b>	ø180mm Paper Tape	4000
<b>J</b>	ø330mm Paper Tape	10000
<b>B</b>	Bulk(Bag)	1000

BLM21BD222SZ1/BLM21BD222SH1/BLM21BD272SZ1/BLM21BD272SH1 only

Code	Packaging	Minimum Quantity
<b>K</b>	ø330mm Embossed Tape	10000
<b>L</b>	ø180mm Embossed Tape	3000
<b>B</b>	Bulk(Bag)	1000

### Equivalent Circuit



(Resistance element becomes dominant at high frequencies.)

### Rated Value (□: packaging code)

Part Number		Impedance at 100MHz	Rated Current at 85°C	Rated Current at 125°C	DC Resistance (Max.)
Infotainment	Powertrain/Safety				
BLM21BB050SZ1□	BLM21BB050SH1□	5Ω±25%	1A	1A	0.02Ω
BLM21BB600SZ1□	BLM21BB600SH1□	60Ω±25%	800mA	800mA	0.13Ω
BLM21BB750SZ1□	BLM21BB750SH1□	75Ω±25%	700mA	700mA	0.16Ω
BLM21BB121SZ1□	BLM21BB121SH1□	120Ω±25%	600mA	600mA	0.19Ω
BLM21BB151SZ1□	BLM21BB151SH1□	150Ω±25%	600mA	600mA	0.21Ω
BLM21BB201SZ1□	BLM21BB201SH1□	200Ω±25%	500mA	500mA	0.26Ω
BLM21BB221SZ1□	BLM21BB221SH1□	220Ω±25%	500mA	500mA	0.26Ω
BLM21BB331SZ1□	BLM21BB331SH1□	330Ω±25%	400mA	400mA	0.33Ω
BLM21BB471SZ1□	BLM21BB471SH1□	470Ω±25%	400mA	400mA	0.4Ω
BLM21BD121SZ1□	BLM21BD121SH1□	120Ω±25%	350mA	350mA	0.25Ω
BLM21BD151SZ1□	BLM21BD151SH1□	150Ω±25%	350mA	350mA	0.25Ω
BLM21BD221SZ1□	BLM21BD221SH1□	220Ω±25%	350mA	350mA	0.25Ω
BLM21BD331SZ1□	BLM21BD331SH1□	330Ω±25%	300mA	300mA	0.3Ω
BLM21BD421SZ1□	BLM21BD421SH1□	420Ω±25%	300mA	300mA	0.3Ω
BLM21BD471SZ1□	BLM21BD471SH1□	470Ω±25%	300mA	300mA	0.35Ω
BLM21BD601SZ1□	BLM21BD601SH1□	600Ω±25%	300mA	300mA	0.35Ω
BLM21BD751SZ1□	BLM21BD751SH1□	750Ω±25%	250mA	250mA	0.4Ω
BLM21BD102SZ1□	BLM21BD102SH1□	1000Ω±25%	250mA	250mA	0.4Ω
BLM21BD152SZ1□	BLM21BD152SH1□	1500Ω±25%	250mA	250mA	0.45Ω
BLM21BD182SZ1□	BLM21BD182SH1□	1800Ω±25%	250mA	250mA	0.5Ω
BLM21BD222TZ1□	BLM21BD222TH1□	2200Ω±25%	200mA	200mA	0.6Ω
BLM21BD222SZ1□	BLM21BD222SH1□	2250Ω(Typ.)	250mA	250mA	0.6Ω
BLM21BD272SZ1□	BLM21BD272SH1□	2700Ω±25%	200mA	200mA	0.8Ω

Operating Temp. Range: -55°C to 125°C

Continued on the following page. ↗

Continued from the preceding page. ↘

**Z-f characteristics: BLM21BB\_SZ1 series**

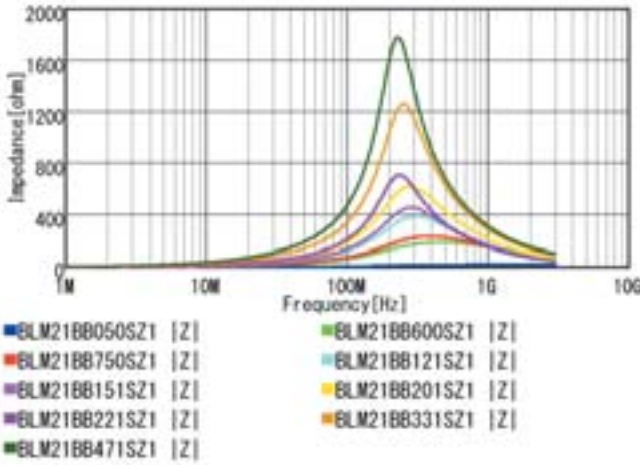

**Z-f characteristics: BLM21BB\_SH1 series**

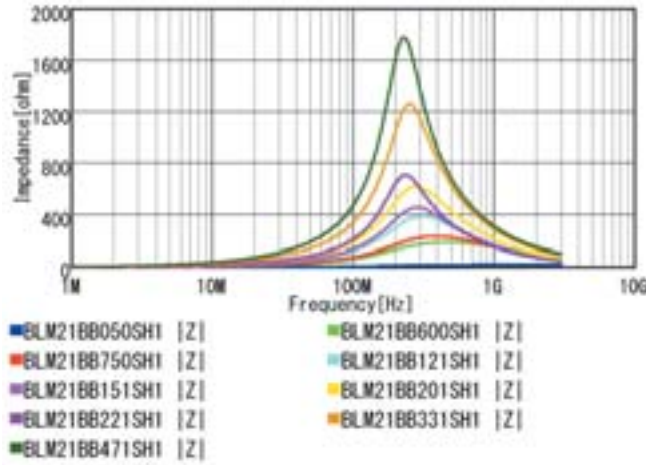

**Z-f characteristics: BLM21BD\_SZ1/TZ1 series**

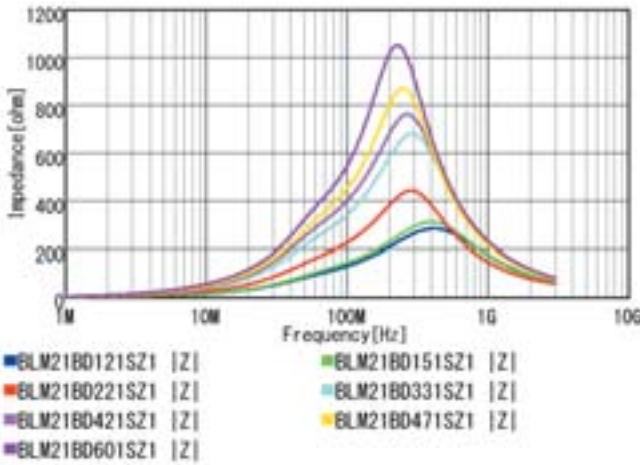

**Z-f characteristics: BLM21BD\_SH1/TH1 series**

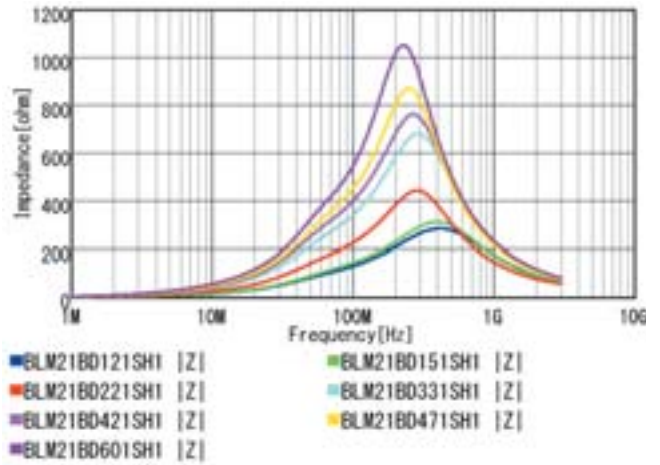

**Z-f characteristics: BLM21BD\_SZ1/TZ1 series**

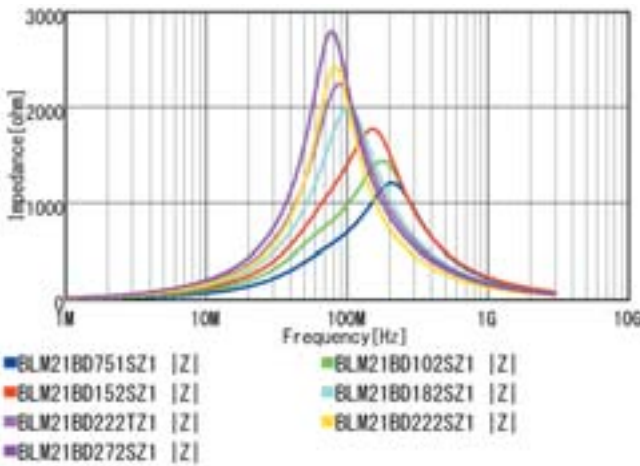

**Z-f characteristics: BLM21BD\_SH1/TH1 series**

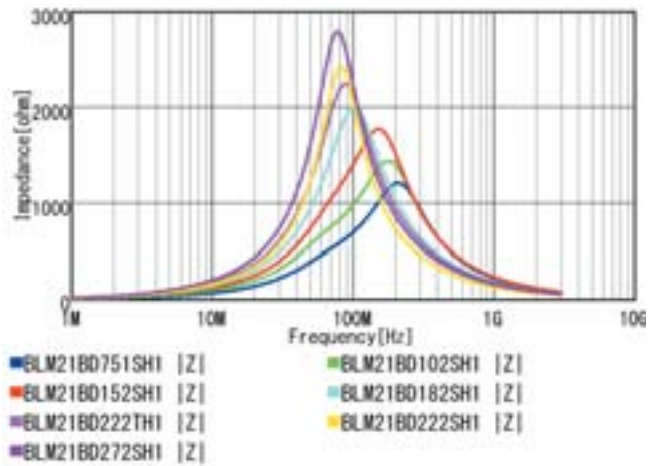

Continued on the following page. ↗

SMD Type  
 Chip Ferrite Bead  
 SMD Type  
 Chip EMIFIL®  
 SMD Type  
 Chip Common Mode Choke Coil  
 SMD Type  
 Block Type EMIFIL®  
 Lead Type  
 EMI Suppression Filters  
 SMD Type  
 Microchip Transformer (Balun)

Continued from the preceding page. ↘

## Z-f characteristics

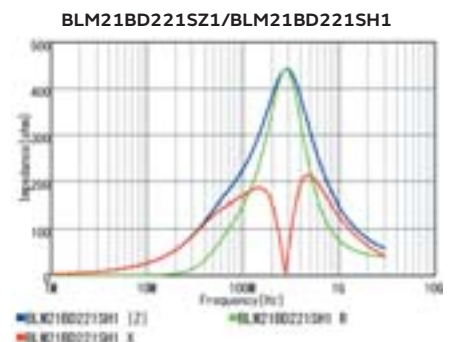
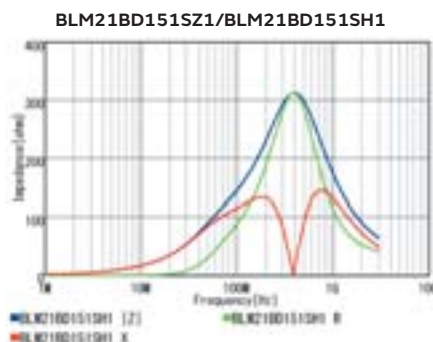
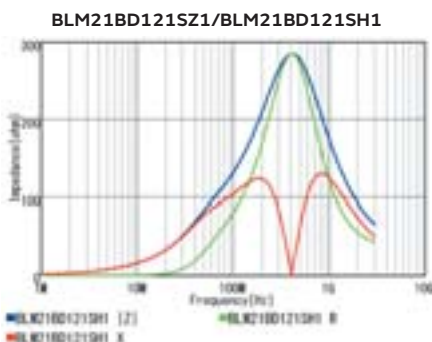
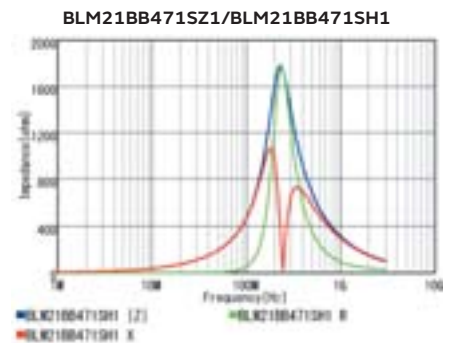
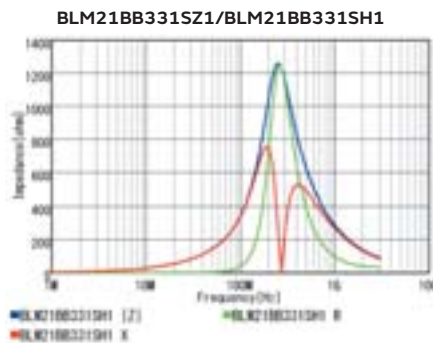
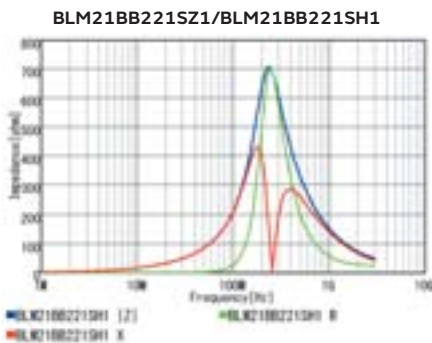
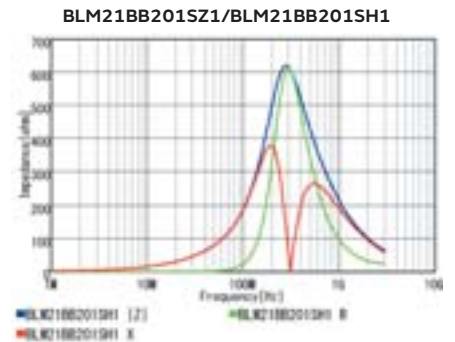
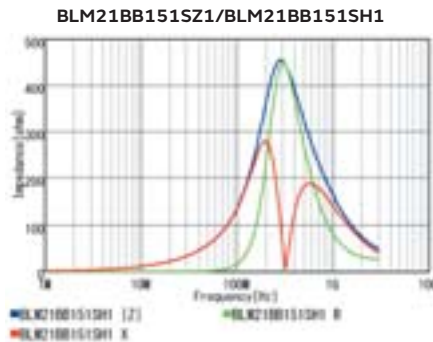
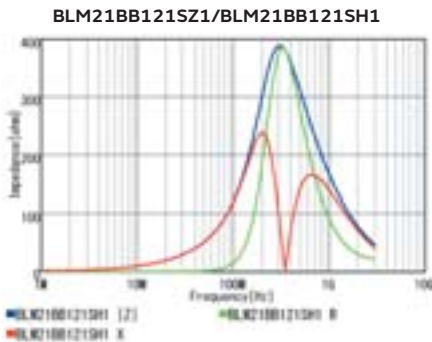
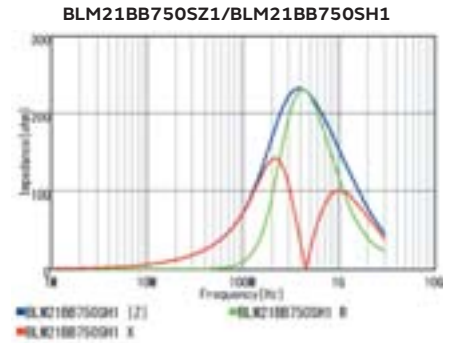
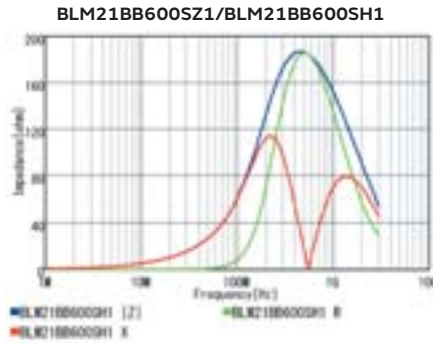
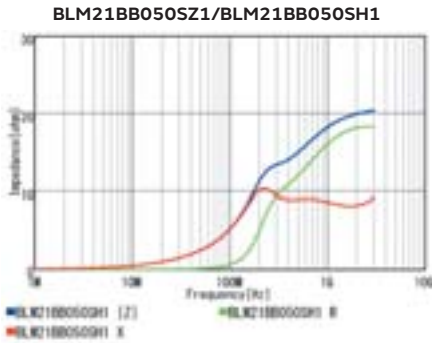

Continued on the following page. ↗

Chip Ferrite Bead SMD Type  
 Chip Common Mode Choke Coil SMD Type  
 Block Type EMIFIL® SMD Type  
 EMI Suppression Filters Lead Type  
 Microchip Transformer (Balun) SMD Type



Continued from the preceding page. ↘

**Z-f characteristics**

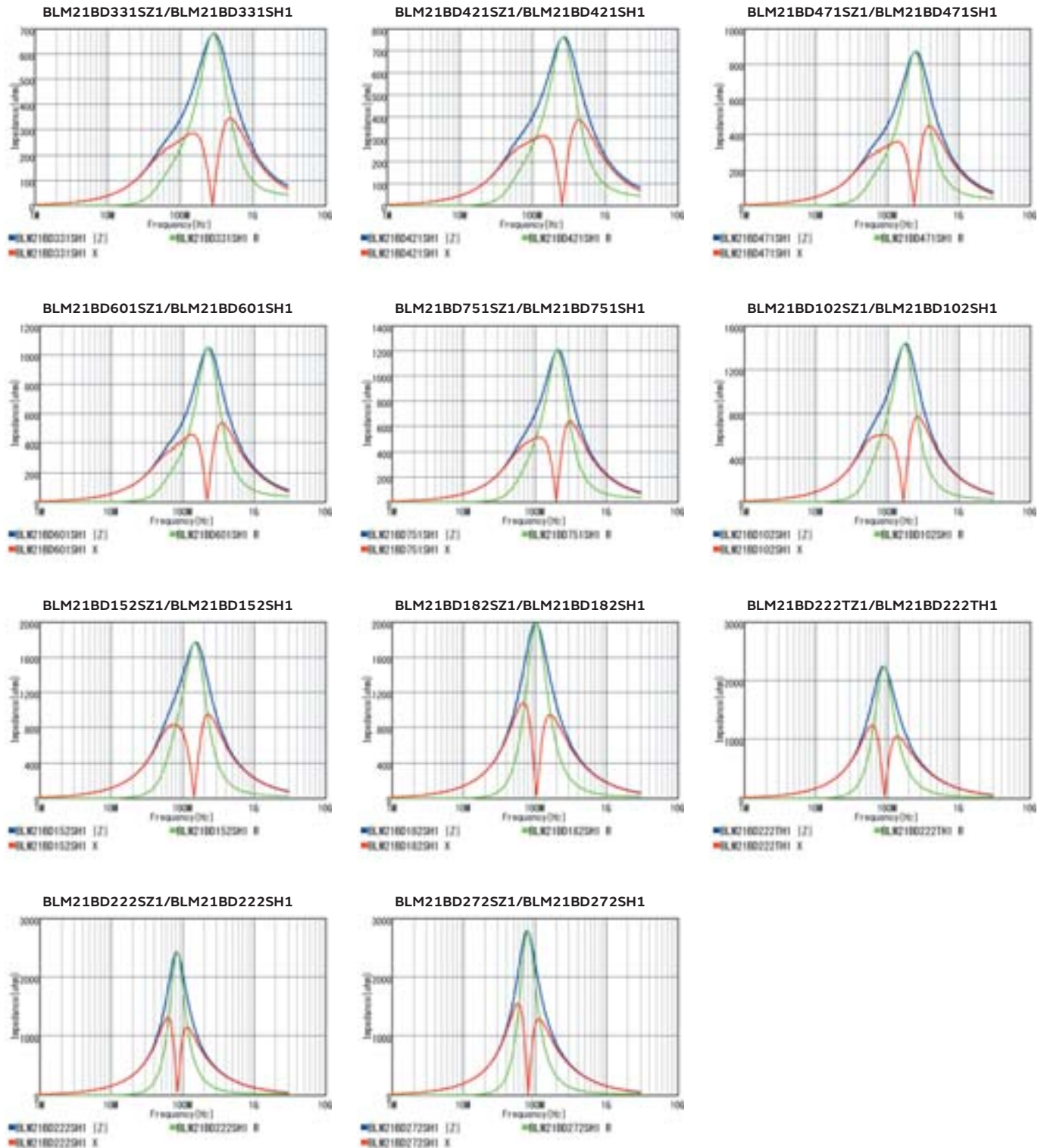

SMD Type  
 Chip Ferrite Bead

SMD Type  
 Chip EMI FIL®

SMD Type  
 Chip Common Mode Choke Coil

SMD Type  
 Block Type EMI FIL®

Lead Type  
 EMI Suppression Filters

SMD Type  
 Microchip Transformer (Balun)

# Chip Ferrite Bead SMD Type

## BLM31PG Series 1206/3216(inch/mm)

### Appearance/Dimensions

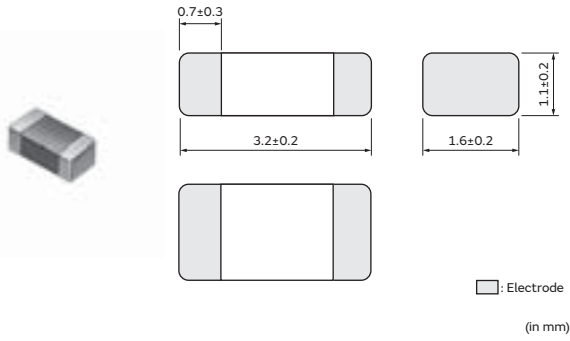

### Packaging

Code	Packaging	Minimum Quantity
K	ø330mm Embossed Tape	10000
L	ø180mm Embossed Tape	3000
B	Bulk(Bag)	1000

### Equivalent Circuit



(Resistance element becomes dominant at high frequencies.)

### Rated Value (□: packaging code)

Part Number		Impedance at 100MHz	Rated Current at 85°C	Rated Current at 125°C	DC Resistance (Max.)
Infotainment	Powertrain/Safety				
BLM31PG330SZ1□	BLM31PG330SH1□	33Ω±25%	6A	3.5A	0.009Ω
BLM31PG500SZ1□	BLM31PG500SH1□	50Ω(Typ.)	3.5A	2.3A	0.015Ω
BLM31PG121SZ1□	BLM31PG121SH1□	120Ω±25%	3.5A	2A	0.02Ω
BLM31PG391SZ1□	BLM31PG391SH1□	390Ω±25%	2A	1.25A	0.05Ω
BLM31PG601SZ1□	BLM31PG601SH1□	600Ω±25%	1.5A	1A	0.08Ω

Operating Temp. Range: -55°C to 125°C

### Z-f characteristics: BLM31PG\_SZ1 series

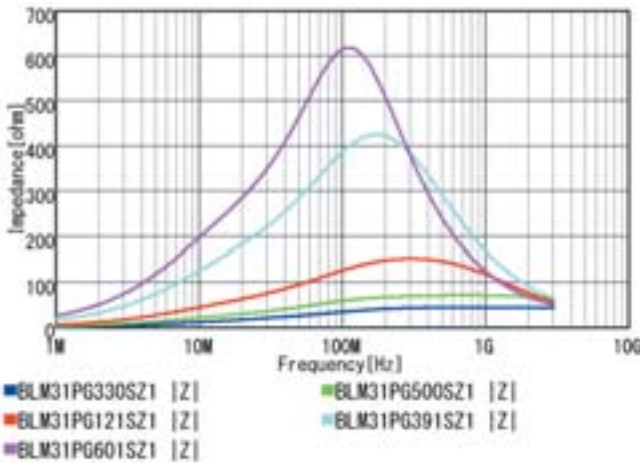

### Z-f characteristics: BLM31PG\_SH1 series

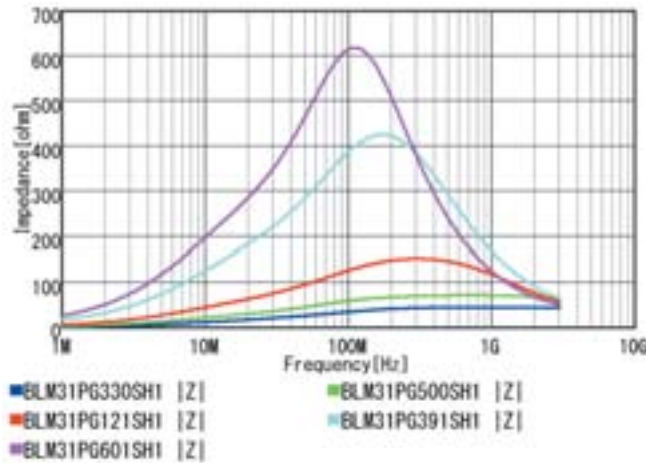

Continued on the following page. ↗

Continued from the preceding page. ↘

### Z-f characteristics

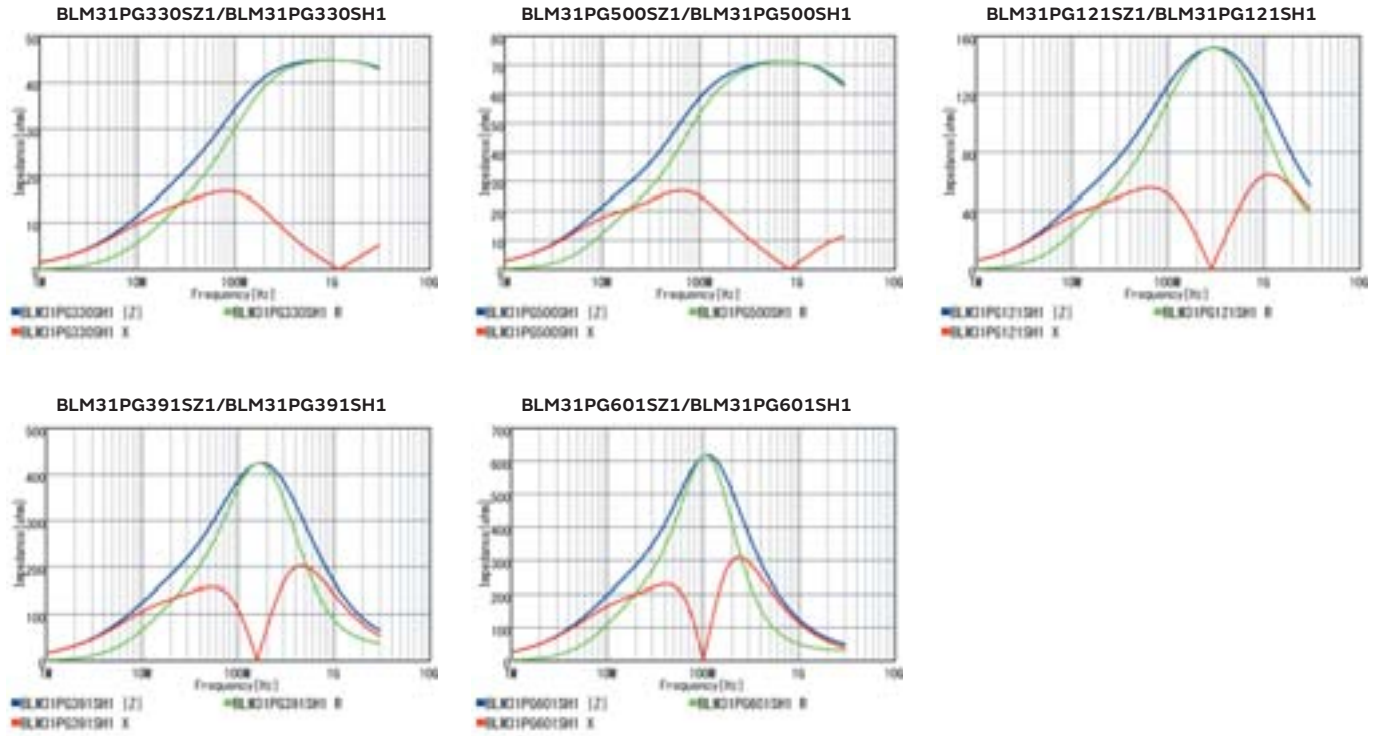

### Derating of Rated Current

In operating temperature exceeding +85°C, derating of current is necessary for BLM31PG series. Please apply the derating curve shown in chart according to the operating temperature.

Derating of Rated Current

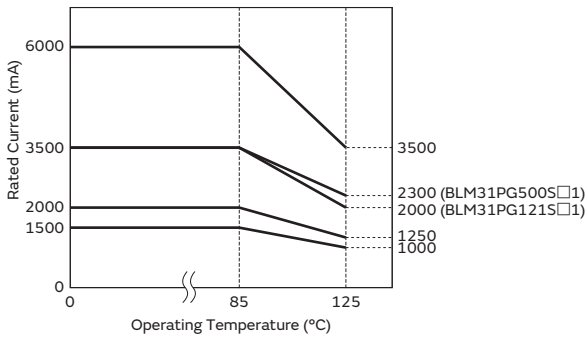

SMD Type  
 Chip Ferrite Bead

SMD Type  
 Chip EMI/FIL®

SMD Type  
 Chip Common Mode Choke Coil

SMD Type  
 Block Type EMI/FIL®

Lead Type  
 EMI Suppression Filters

SMD Type  
 Microchip Transformer (Balun)

# Chip Ferrite Bead SMD Type

## BLM31KN Series 1206/3216(inch/mm)

### Appearance/Dimensions

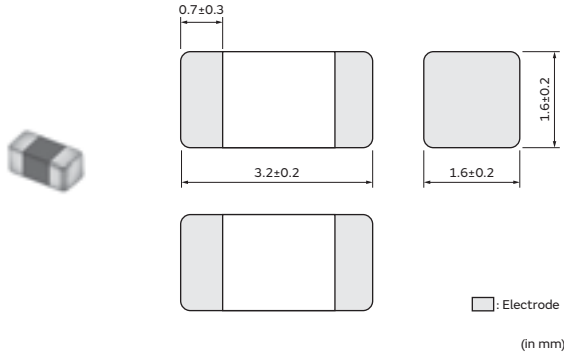

### Packaging

Code	Packaging	Minimum Quantity
K	ø330mm Embossed Tape	8000
L	ø180mm Embossed Tape	2500
B	Bulk(Bag)	1000

### Equivalent Circuit



(Resistance element becomes dominant at high frequencies.)

### Rated Value (□: packaging code)

Part Number		Impedance at 100MHz	Rated Current at 85°C	Rated Current at 125°C	DC Resistance (Max.)
Infotainment	Powertrain/Safety				
BLM31KN121SZ1□	BLM31KN121SH1□	120Ω±25%	6A	4A	0.009Ω
BLM31KN271SZ1□	BLM31KN271SH1□	270Ω±25%	4.5A	3A	0.016Ω
BLM31KN471SZ1□	BLM31KN471SH1□	470Ω±25%	4A	2.7A	0.02Ω
BLM31KN601SZ1□	BLM31KN601SH1□	600Ω±25%	2.9A	2A	0.038Ω
BLM31KN801SZ1□	BLM31KN801SH1□	800Ω±25%	2.5A	1.7A	0.05Ω
BLM31KN102SZ1□	BLM31KN102SH1□	1000Ω±25%	2A	1.4A	0.075Ω

Operating Temp. Range: -55°C to 125°C

### Z-f characteristics: BLM31KN\_SZ1 series

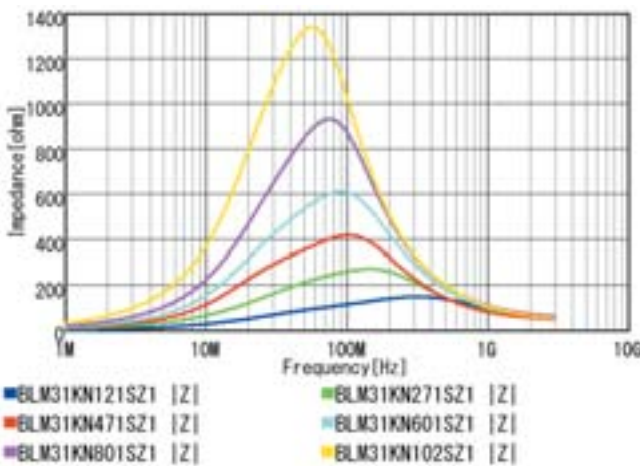

### Z-f characteristics: BLM31KN\_SH1 series

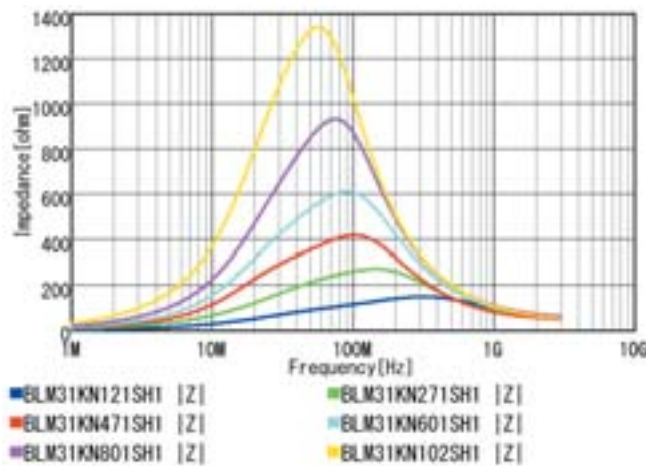

Continued on the following page. ↗

Continued from the preceding page. ↘

## Z-f characteristics

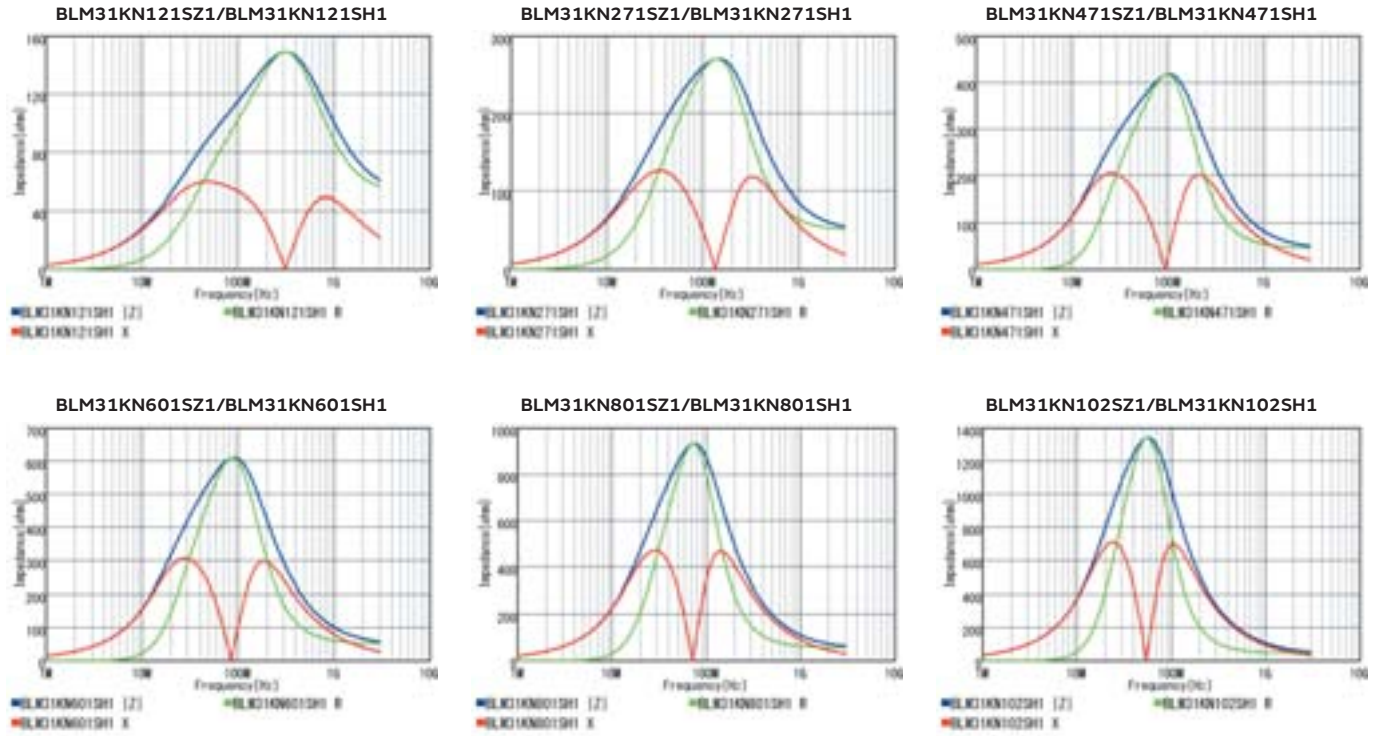

## Derating of Rated Current

In operating temperature exceeding +85°C, derating of current is necessary for BLM31KN series. Please apply the derating curve shown in chart according to the operating temperature.

Derating of Rated Current

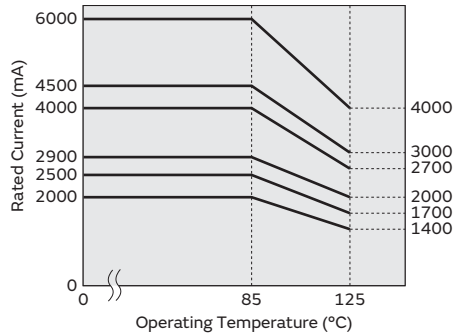

SMD Type  
 Chip Ferrite Bead

SMD Type  
 Chip EMI FIL®

SMD Type  
 Chip Common Mode Choke Coil

SMD Type  
 Block Type EMI FIL®

Lead Type  
 EMI Suppression Filters

SMD Type  
 Microchip Transformer (Balun)

# Chip Ferrite Bead SMD Type

## BLM31KN(150°C available) Series 1206/3216(inch/mm)

### Appearance/Dimensions

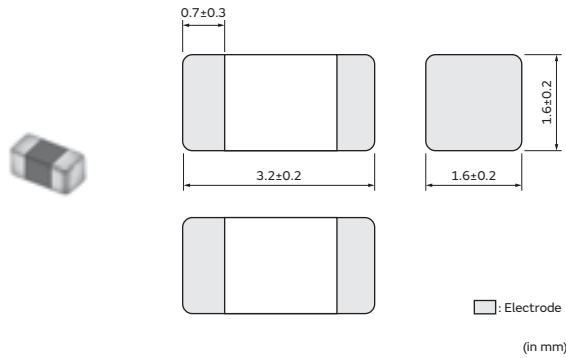

### Packaging

Code	Packaging	Minimum Quantity
K	ø330mm Embossed Tape	8000
L	ø180mm Embossed Tape	2500
B	Bulk(Bag)	1000

### Equivalent Circuit



(Resistance element becomes dominant at high frequencies.)

### Rated Value (□: packaging code)

Part Number		Impedance at 100MHz	Rated Current at 85°C	Rated Current at 125°C	DC Resistance (Max.)
Infotainment	Powertrain/Safety				
—	BLM31KN121BH1□	120Ω±25%	4A	4A	0.009Ω
—	BLM31KN271BH1□	270Ω±25%	3A	3A	0.016Ω
—	BLM31KN471BH1□	470Ω±25%	2.7A	2.7A	0.02Ω
—	BLM31KN601BH1□	600Ω±25%	2A	2A	0.038Ω
—	BLM31KN801BH1□	800Ω±25%	1.7A	1.7A	0.05Ω
—	BLM31KN102BH1□	1000Ω±25%	1.4A	1.4A	0.075Ω

Rated Current at 150°C: 10mA  
 Operating Temp. Range: -55°C to 150°C

### Z-f characteristics: BLM31KN\_BH1 series

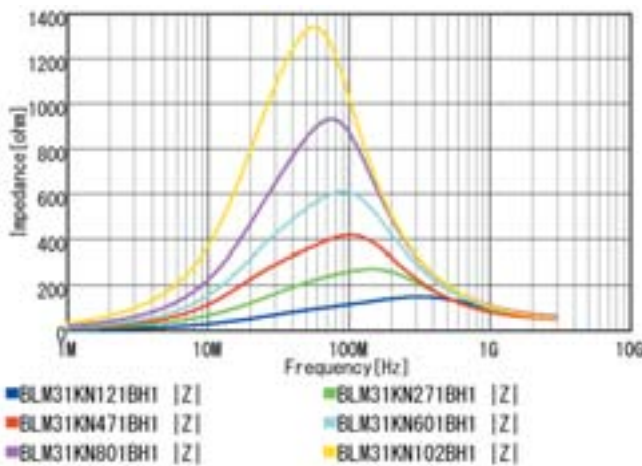

Continued on the following page. ↗

Continued from the preceding page. ↘

## Z-f characteristics

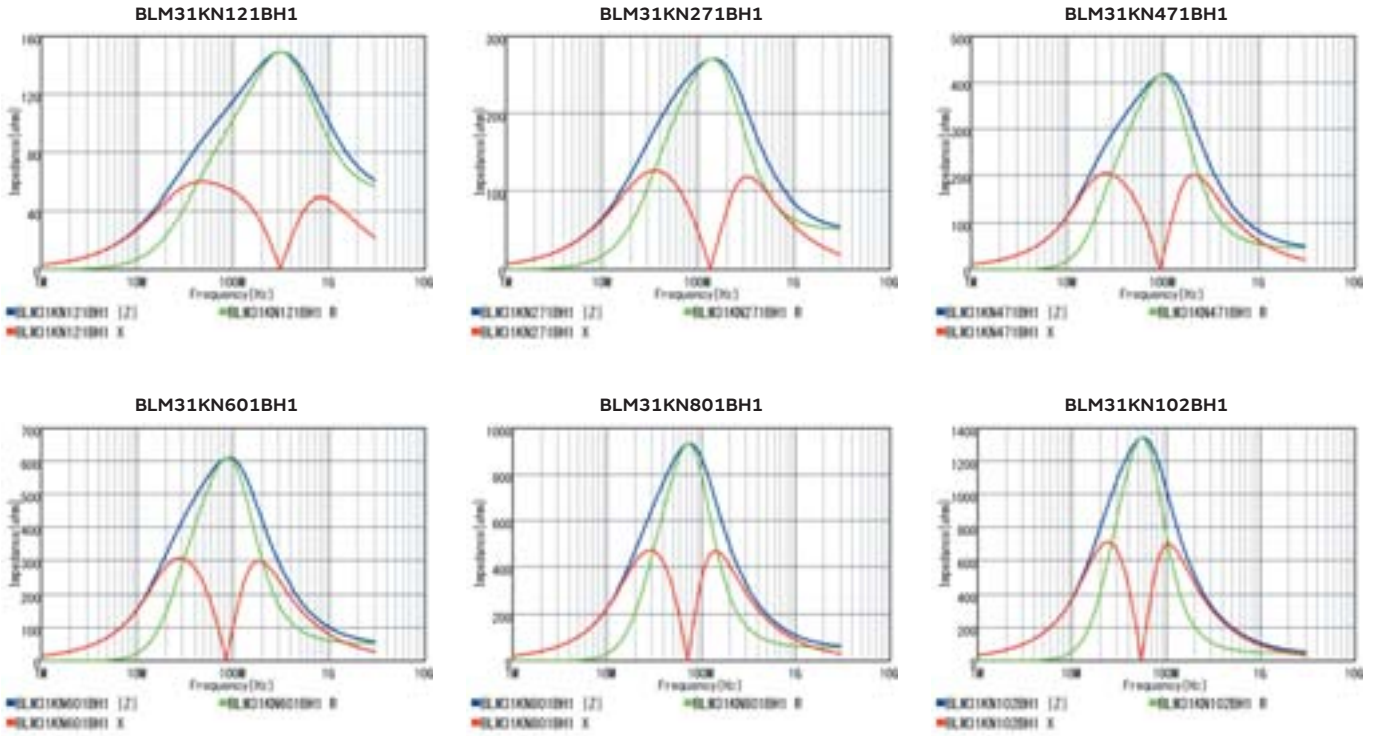

## Derating of Rated Current

In operating temperature exceeding +125°C, derating of current is necessary for BLM31KN\_BH1 series. Please apply the derating curve shown in chart according to the operating temperature.

Derating of Rated Current

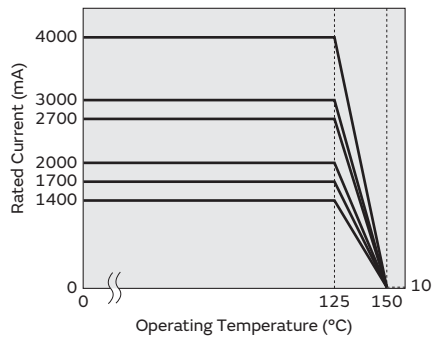

SMD Type  
 Chip Ferrite Bead

SMD Type  
 Chip EMIFIL®

SMD Type  
 Chip Common Mode Choke Coil

SMD Type  
 Block Type EMIFIL®

Lead Type  
 EMI Suppression Filters

SMD Type  
 Microchip Transformer (Balun)

Chip Ferrite Bead  
 SMD Type

Chip EMIFIL®  
 SMD Type

Chip Common Mode Choke Coil  
 SMD Type

Block Type EMIFIL®  
 SMD Type

EMI Suppression Filters  
 Lead Type

Microchip Transformer (Balun)  
 SMD Type

# Chip Ferrite Bead SMD Type

## BLM31SN Series 1206/3216(inch/mm)

### Appearance/Dimensions

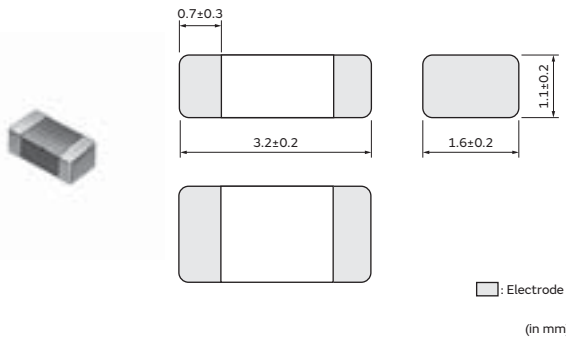

### Packaging

Code	Packaging	Minimum Quantity
L	ø180mm Embossed Tape	3000
B	Bulk(Bag)	1000

### Equivalent Circuit

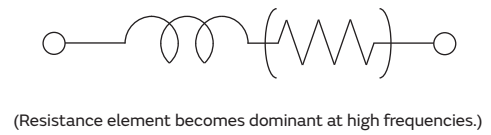

### Rated Value (□: packaging code)

Part Number		Impedance at 100MHz	Rated Current at 85°C	Rated Current at 125°C	DC Resistance (Max.)	Operating Temp. Range
Infotainment	Powertrain/Safety					
BLM31SN500SZ1□	BLM31SN500SH1□	50Ω±12.5Ω	12A	10A	0.0016Ω	-55°C to 125°C

### Z-f characteristics

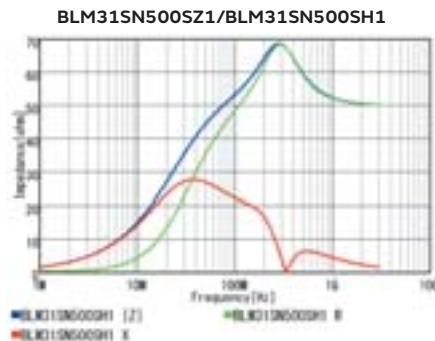

### Derating of Rated Current

In operating temperature exceeding +85°C, derating of current is necessary for BLM31SN series. Please apply the derating curve shown in chart according to the operating temperature.

Derating of Rated Current

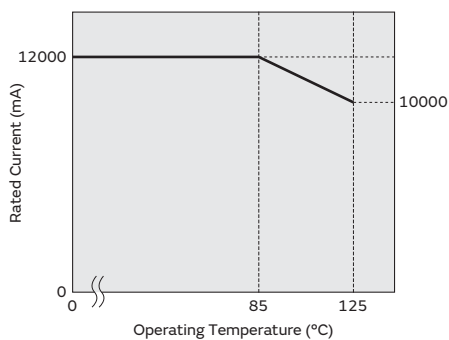



# Chip Ferrite Bead SMD Type

## BLM31AJ Series 1206/3216(inch/mm)

### Appearance/Dimensions

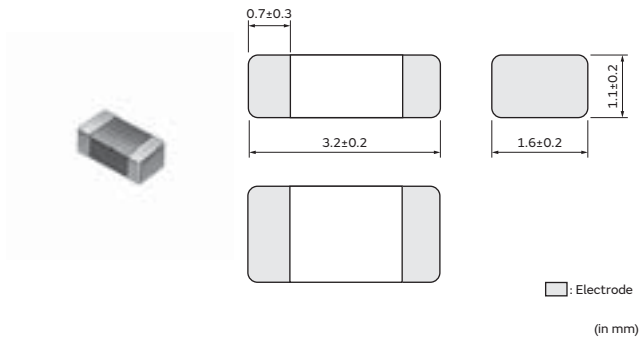

### Packaging

Code	Packaging	Minimum Quantity
K	ø330mm Embossed Tape	10000
L	ø180mm Embossed Tape	3000
B	Bulk(Bag)	1000

### Equivalent Circuit



(Resistance element becomes dominant at high frequencies.)

### Rated Value (□: packaging code)

Part Number		Impedance at 100MHz	Rated Current at 85°C	Rated Current at 125°C	DC Resistance (Max.)	Operating Temp. Range
Infotainment	Powertrain/Safety					
—	BLM31AJ601SH1□	600Ω±25%	200mA	200mA	0.9Ω	-55°C to 125°C

### Z-f characteristics

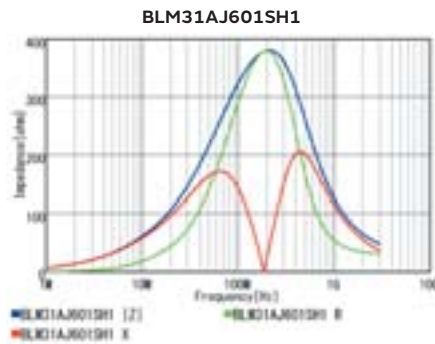

SMD Type  
 Chip Ferrite Bead

SMD Type  
 Chip EMIFIL®

SMD Type  
 Chip Common Mode Choke Coil

SMD Type  
 Block Type EMIFIL®

Lead Type  
 EMI Suppression Filters

SMD Type  
 Microchip Transformer (Balun)

# Chip Ferrite Bead SMD Type

## BLM41PG Series 1806/4516(inch/mm)

### Appearance/Dimensions

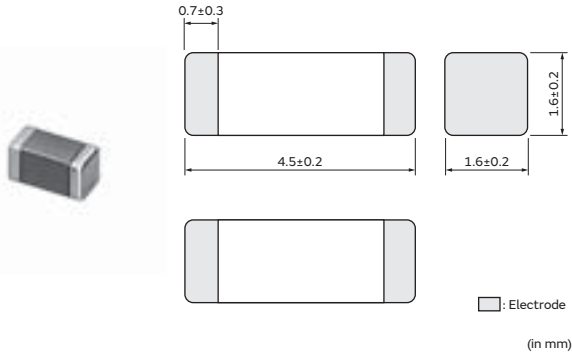

### Packaging

Code	Packaging	Minimum Quantity
K	ø330mm Embossed Tape	8000
L	ø180mm Embossed Tape	2500
B	Bulk(Bag)	1000

### Equivalent Circuit



(Resistance element becomes dominant at high frequencies.)

### Rated Value (□: packaging code)

Part Number		Impedance at 100MHz	Rated Current at 85°C	Rated Current at 125°C	DC Resistance (Max.)
Infotainment	Powertrain/Safety				
BLM41PG600SZ1□	BLM41PG600SH1□	60Ω(Typ.)	6A	3.7A	0.009Ω
BLM41PG750SZ1□	BLM41PG750SH1□	75Ω(Typ.)	3.5A	2.45A	0.015Ω
BLM41PG181SZ1□	BLM41PG181SH1□	180Ω±25%	3.5A	2.1A	0.02Ω
BLM41PG471SZ1□	BLM41PG471SH1□	470Ω±25%	2A	1.35A	0.05Ω
BLM41PG102SZ1□	BLM41PG102SH1□	1000Ω±25%	1.5A	1A	0.09Ω

Operating Temp. Range: -55°C to 125°C

### Z-f characteristics: BLM41PG\_SZ1 series

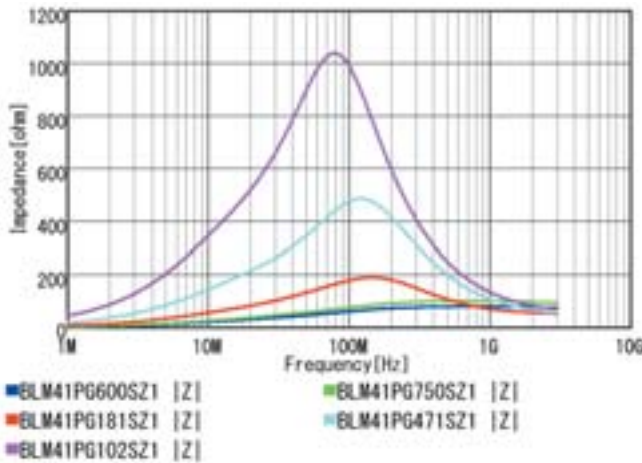

### Z-f characteristics: BLM41PG\_SH1 series

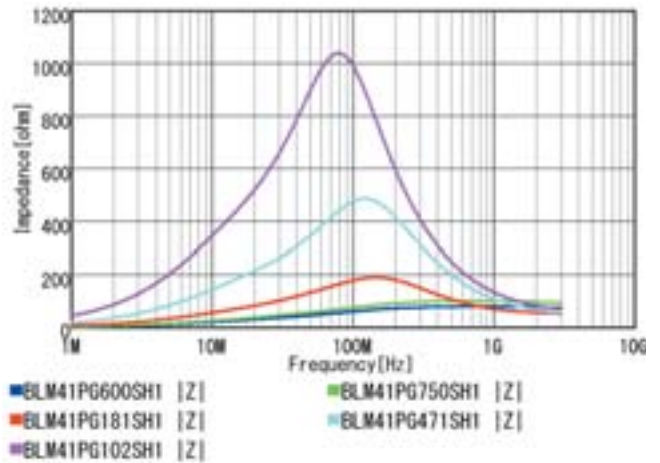

Continued on the following page. ↗

Continued from the preceding page. ↘

### Z-f characteristics

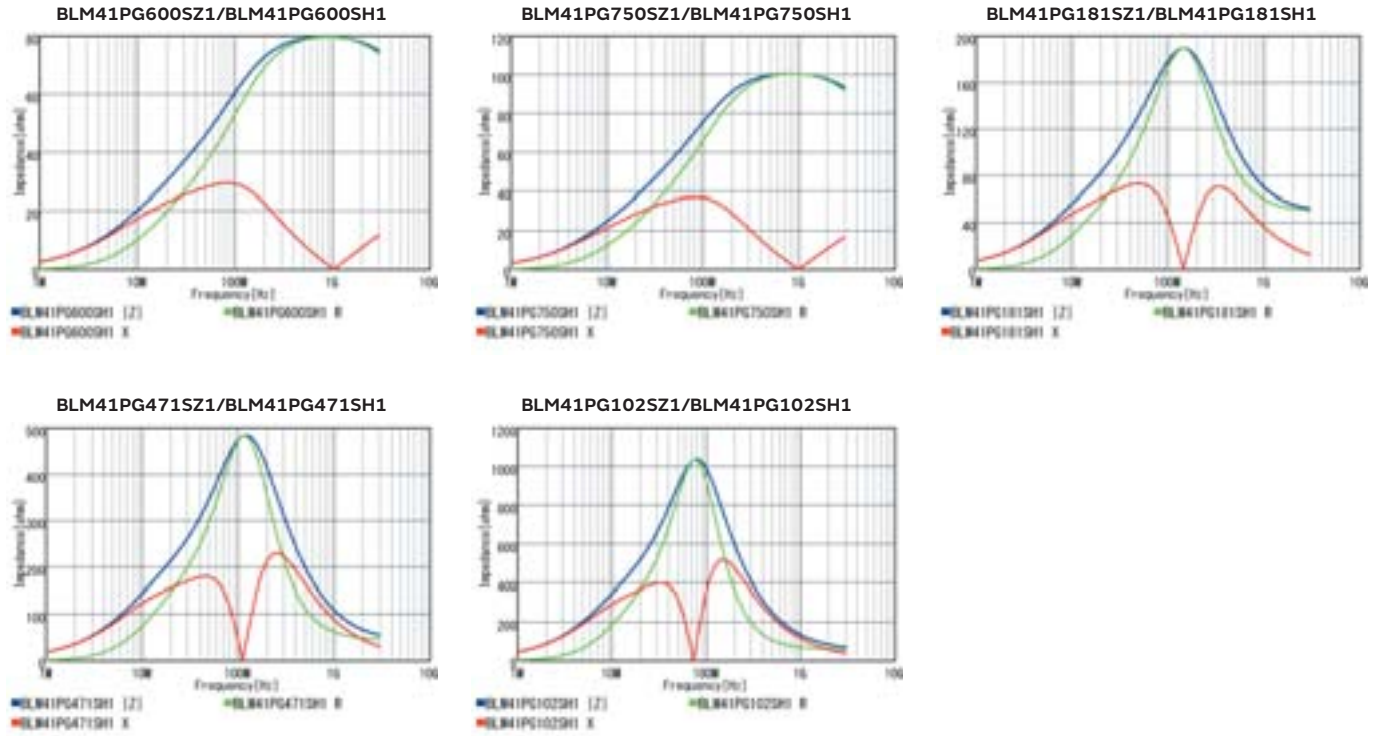

### Derating of Rated Current

In operating temperature exceeding +85°C, derating of current is necessary for BLM41PG series. Please apply the derating curve shown in chart according to the operating temperature.

Derating of Rated Current

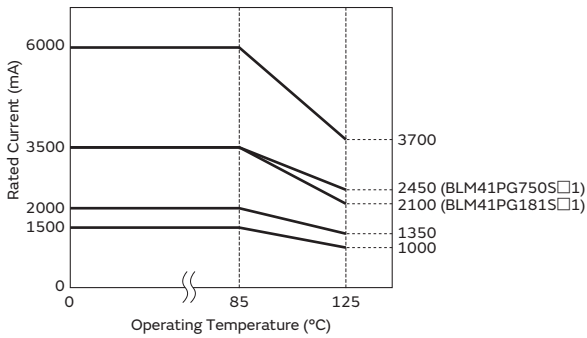

SMD Type  
 Chip Ferrite Bead

SMD Type  
 Chip EMI/FIL®

SMD Type  
 Chip Common Mode Choke Coil

SMD Type  
 Block Type EMI/FIL®

Lead Type  
 EMI Suppression Filters

SMD Type  
 Microchip Transformer (Balun)

# Chip Power Bead SMD Type

## BLE18PS Series 0603/1608(inch/mm)

### Appearance/Dimensions

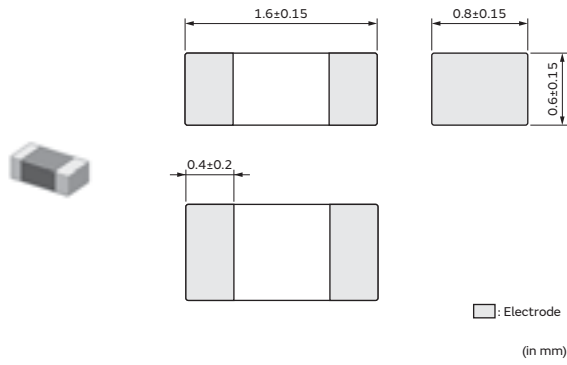

### Packaging

Code	Packaging	Minimum Quantity
D	ø180mm Paper Tape	4000
J	ø330mm Paper Tape	10000
B	Bulk(Bag)	1000

### Equivalent Circuit

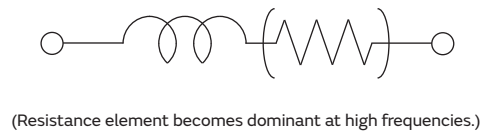

### Rated Value (□: packaging code)

Part Number		Impedance at 100MHz	Rated Current at 85°C	Rated Current at 125°C	DC Resistance (Max.)	Operating Temp. Range
Infotainment	Powertrain/Safety					
BLE18PS080SZ1□	—	8.5Ω±25%	8A	5A	0.004Ω	-55°C to 125°C

### Z-f characteristics

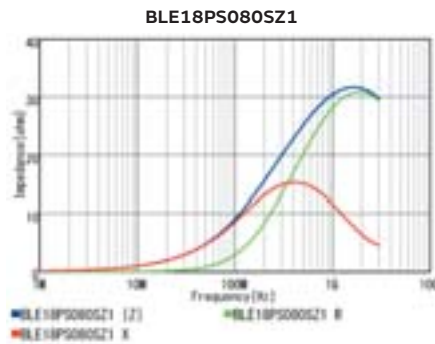

### Derating of Rated Current

In operating temperature exceeding +85°C, derating of current is necessary for BLE18PS series. Please apply the derating curve shown in chart according to the operating temperature.

Derating of Rated Current

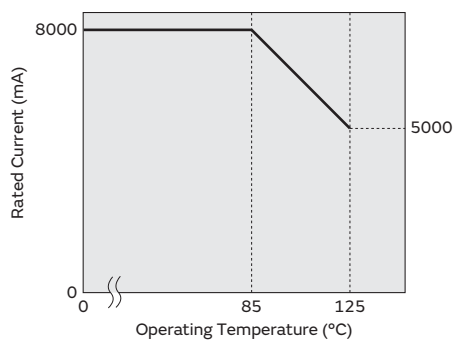

# Chip Power Bead SMD Type

## BLE32PN Series 1210/3225(inch/mm)

### Appearance/Dimensions

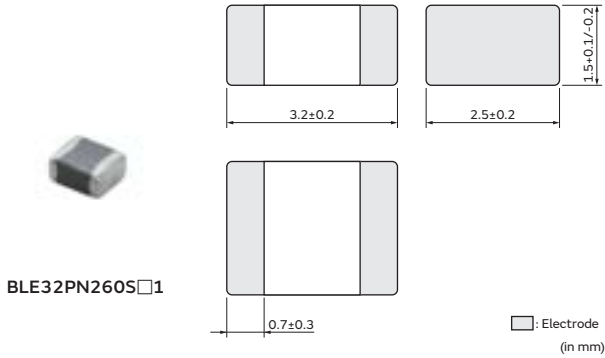

### Packaging

Code	Packaging	Minimum Quantity
K	ø330mm Embossed Tape	7000
L	ø180mm Embossed Tape	1500
B	Bulk(Bag)	1000

### Equivalent Circuit

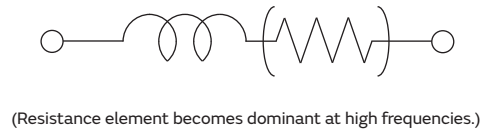

### Appearance/Dimensions

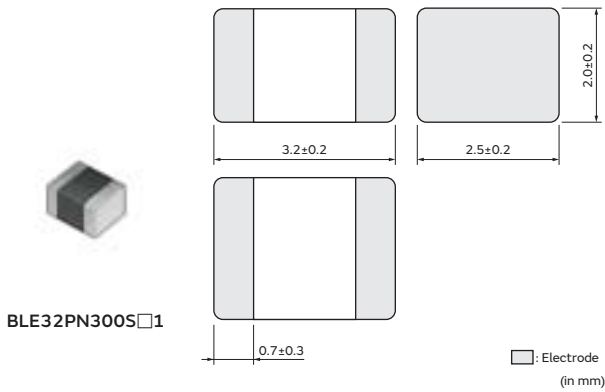

### Rated Value (□: packaging code)

Part Number		Impedance at 100MHz	Rated Current at 85°C	Rated Current at 125°C	DC Resistance (Max.)
Infotainment	Powertrain/Safety				
BLE32PN260SZ1□	BLE32PN260SH1□	26Ω±10Ω	10A	10A	1.6mΩ
BLE32PN300SZ1□	BLE32PN300SH1□	30Ω±10Ω	10A	10A	1.6mΩ

Operating Temp. Range: -55°C to 125°C

Continued on the following page. ↗

SMD Type  
 Chip Ferrite Bead

SMD Type  
 Chip EMIFIL®

SMD Type  
 Chip Common Mode Choke Coil

SMD Type  
 Block Type EMIFIL®

Lead Type  
 EMI Suppression Filters

SMD Type  
 Microchip Transformer (Balun)

Continued from the preceding page. ↘

**Z-f characteristics: BLE32PN\_SZ1 series**

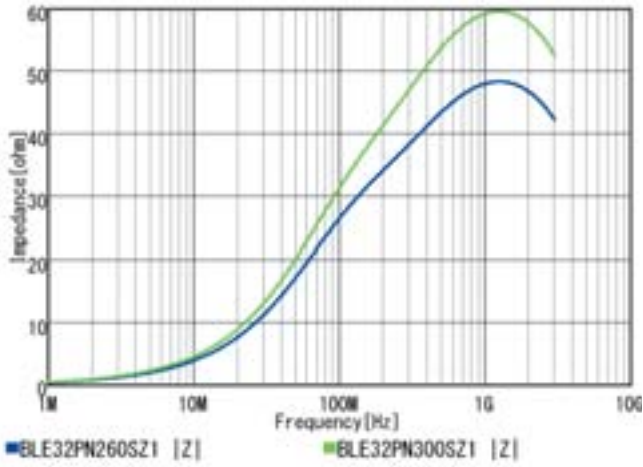

**Z-f characteristics: BLE32PN\_SH1 series**

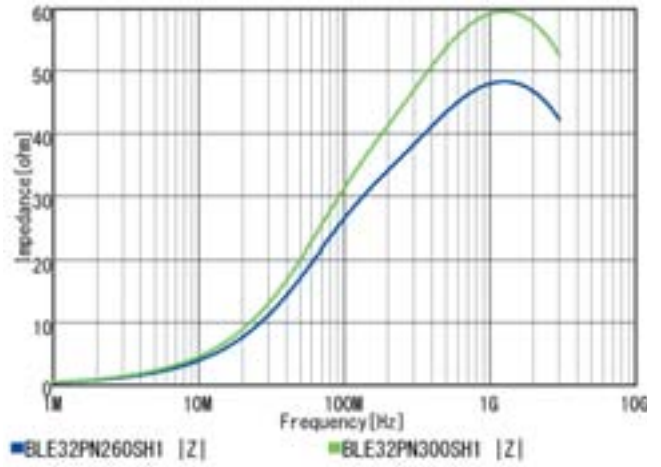

**BLE32PN260SZ1/BLE32PN260SH1**

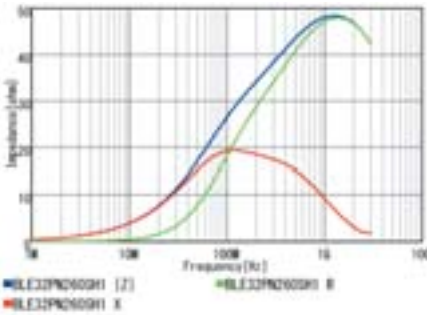

**BLE32PN300SZ1/BLE32PN300SH1**

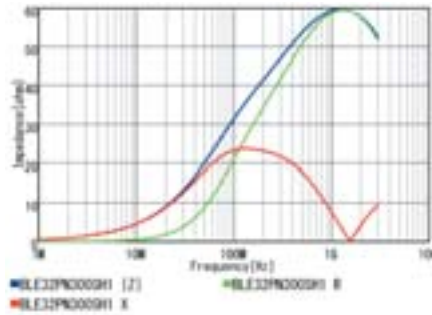

## Chip Ferrite Bead (BL□ Series) ⚠Caution/Notice

### ⚠Caution

#### Rating

1. About the Rated Current  
Do not use products beyond the rated current as this may create excessive heat and deteriorate the insulation resistance.
2. About the Excessive Surge Current  
Excessive surge current (pulse current or rush current)

than specified rated current applied to the product may cause a critical failure, such as an open circuit, burnout caused by excessive temperature rise. Please contact us in advance in case of applying the surge current.

#### Soldering and Mounting

1. Self-heating  
Please pay special attention when mounting chip ferrite beads BLM□□AX/P/K/S series chip power beads BLE series in close proximity to other products that radiate heat. The heat generated by other products may deteriorate the insulation resistance and cause excessive heat in this component.
2. Terminal Connection (BLT)  
The terminations shall be connected correctly. The product consists of two coils. In order to provide the appropriate performance, two terminations shall be connected to the single power line and used as one coil.

If the terminations are connected to the power line and ground line separately, serious problems such as open circuit, short circuit, or flames might be caused due to extreme heat generation.

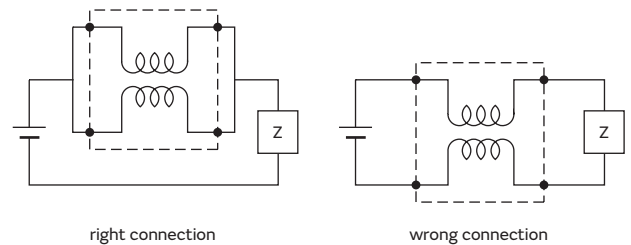

### Notice

#### Storage and Operating Conditions

<Operating Environment>  
Do not use products in the corrodible atmosphere such as acidic gases, alkaline gases, chlorine, sulfur gases, organic gases. (the sea breeze, Cl<sub>2</sub>, H<sub>2</sub>S, NH<sub>3</sub>, SO<sub>2</sub>, NO<sub>2</sub>, etc)  
Do not use products in the environment close to the organic solvent.

<Storage and Handling Requirements>

1. Storage Period  
BLM15E/15H/15G series should be used within 12

months, the other series should be used within 6 months. Solderability should be checked if this period is exceeded.

2. Storage Conditions
  - (1) Storage temperature: -10 to +40°C  
Relative humidity: 15 to 85%  
Avoid sudden changes in temperature and humidity.
  - (2) Do not store products in a chemical atmosphere such as chlorine gas, acid or sulfide gas.

#### Notice (Soldering and Mounting)

1. Cleaning  
Failure and degradation of a product are caused by the cleaning method. When you clean in conditions that are not in mounting information, please contact Murata engineering.
2. Soldering  
Reliability decreases with improper soldering methods. Please solder by the standard soldering conditions shown in mounting information.
3. Mounting on-board with Conductive Glue  
BLM18AG□□□WH is designed for conductive glue mounting method. Please refer to Mounting information.

4. Other  
Noise suppression levels resulting from Murata's EMI suppression filters EMIFIL® may vary, depending on the circuits and ICs used, type of noise, mounting pattern, mounting location, and other operating conditions. Be sure to check and confirm in advance the noise suppression effect of each filter, in actual circuits, etc. before applying the filter in a commercial-purpose equipment design.

Continued on the following page. ↗

## Chip Ferrite Bead (BL□ Series) ⚠️Caution/Notice

Continued from the preceding page. ↘

### Handling

#### 1. Resin Coating

Using resin for coating/molding products may affect the products performance.

So please pay careful attention in selecting resin.

Prior to use, please make the reliability evaluation with the product mounted in your application set.

#### 2. Handling of a Substrate

After mounting products on a substrate, do not apply any stress to the product caused by bending or twisting to the substrate when cropping the substrate, inserting and removing a connector from the substrate or tightening screw to the substrate.

Excessive mechanical stress may cause cracking in the Product.

#### 3. Mounting Density

Add special attention to radiating heat of products when mounting the inductor near the products with heating.

The excessive heat by other products may cause deterioration at joint of this product with substrate.

Bending

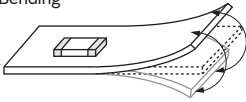

Twisting

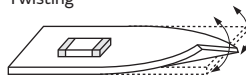



# Chip Ferrite Bead (BL□ Series) Soldering and Mounting

## 1. Standard Land Pattern Dimensions

■ Land Pattern + Solder Resist    □ Land Pattern    □ Solder Resist (in mm)

Series	Standard Land Dimensions																																																																																																																																																																																																																																																															
<b>BLE18</b> <b>BLE32</b> <b>BLM03</b> <b>BLM15</b> <b>BLM18</b> <b>BLM21</b> <b>BLM31</b> <b>BLM41</b>	<b>●Reflow and Flow</b> BLM Series (Except for type (2).) *Please refer to (1).																																																																																																																																																																																																																																																															
						(1)																																																																																																																																																																																																																																																										
						<table border="1"> <thead> <tr> <th>Type</th> <th>Soldering</th> <th>a</th> <th>b</th> <th>c</th> </tr> </thead> <tbody> <tr> <td><b>BLM03</b></td> <td>Reflow</td> <td>0.25</td> <td>0.8</td> <td>0.3</td> </tr> <tr> <td><b>BLM15</b></td> <td>Reflow</td> <td>0.4</td> <td>1.2</td> <td>0.5</td> </tr> <tr> <td rowspan="2"><b>BLM18</b></td> <td>Flow (except 18G)</td> <td>0.8</td> <td>2.5</td> <td rowspan="2">0.7</td> </tr> <tr> <td>Reflow</td> <td>0.7</td> <td>2.0</td> </tr> <tr> <td rowspan="2"><b>BLM21</b></td> <td>Flow</td> <td>1.1</td> <td>3.5</td> <td>0.95</td> </tr> <tr> <td>Reflow</td> <td>1.2</td> <td>2.4</td> <td>1.25</td> </tr> </tbody> </table>					Type	Soldering	a	b	c	<b>BLM03</b>	Reflow	0.25	0.8	0.3	<b>BLM15</b>	Reflow	0.4	1.2	0.5	<b>BLM18</b>	Flow (except 18G)	0.8	2.5	0.7	Reflow	0.7	2.0	<b>BLM21</b>	Flow	1.1	3.5	0.95	Reflow	1.2	2.4	1.25																																																																																																																																																																																																																						
	Type	Soldering	a	b	c																																																																																																																																																																																																																																																											
	<b>BLM03</b>	Reflow	0.25	0.8	0.3																																																																																																																																																																																																																																																											
	<b>BLM15</b>	Reflow	0.4	1.2	0.5																																																																																																																																																																																																																																																											
	<b>BLM18</b>	Flow (except 18G)	0.8	2.5	0.7																																																																																																																																																																																																																																																											
		Reflow	0.7	2.0																																																																																																																																																																																																																																																												
	<b>BLM21</b>	Flow	1.1	3.5	0.95																																																																																																																																																																																																																																																											
		Reflow	1.2	2.4	1.25																																																																																																																																																																																																																																																											
	BLE18PS-32PN-BLM□□AX/P/E/K/S-18KG_JH1/_BH1-AG_BH1-BD_BH1 *Please refer to (2).																																																																																																																																																																																																																																																															
						(2)																																																																																																																																																																																																																																																										
	<table border="1"> <thead> <tr> <th rowspan="2">Type</th> <th rowspan="2">Rated Current (A)</th> <th rowspan="2">Soldering</th> <th rowspan="2">a</th> <th rowspan="2">b</th> <th rowspan="2">c</th> <th colspan="3">Land Pad Thickness and Dimension d</th> </tr> <tr> <th>18μm</th> <th>35μm</th> <th>70μm</th> </tr> </thead> <tbody> <tr> <td rowspan="2"><b>BLE18PS</b></td> <td rowspan="2">8</td> <td>Flow</td> <td>0.8</td> <td>2.5</td> <td rowspan="2">0.7</td> <td>-</td> <td>6.4</td> <td>3.3</td> </tr> <tr> <td>Reflow</td> <td>0.7</td> <td>2.0</td> <td>-</td> <td>-</td> <td>-</td> </tr> <tr> <td rowspan="2"><b>BLE32PN</b></td> <td rowspan="2">10</td> <td rowspan="2">Flow/Reflow</td> <td rowspan="2">2.2</td> <td rowspan="2">4.4</td> <td rowspan="2">2.05</td> <td>-</td> <td>4.0 (Temperature 85°C or less)</td> <td>-</td> </tr> <tr> <td>-</td> <td>8.0 (Temperature 125°C or less)</td> <td>-</td> </tr> <tr> <td rowspan="3"><b>BLM03AX</b> <b>BLM03P□</b> <b>BLM03EB</b></td> <td>0.9max.</td> <td rowspan="3">Reflow</td> <td rowspan="3">0.25</td> <td rowspan="3">0.8</td> <td rowspan="3">0.3</td> <td>0.3</td> <td>0.3</td> <td>0.3</td> </tr> <tr> <td>1.8max.</td> <td>1.2</td> <td>0.7</td> <td>0.3</td> </tr> <tr> <td></td> <td></td> <td></td> <td></td> </tr> <tr> <td rowspan="4"><b>BLM15AX</b> <b>BLM15PD</b> <b>BLM15PG</b> <b>BLM15PX</b></td> <td>1.5max.</td> <td rowspan="4">Reflow</td> <td rowspan="4">0.4</td> <td rowspan="4">1.2</td> <td rowspan="4">0.5</td> <td>0.5</td> <td>0.5</td> <td>0.5</td> </tr> <tr> <td>2.2max.</td> <td>1.2</td> <td>0.7</td> <td>0.5</td> </tr> <tr> <td></td> <td>2.4</td> <td>1.2</td> <td>0.5</td> </tr> <tr> <td>3.0max.</td> <td></td> <td></td> <td></td> </tr> <tr> <td rowspan="4"><b>BLM18PG_S□1</b> <b>BLM18KG_S□1</b> <b>BLM18KG_T□1</b> <b>BLM18SG_T□1</b></td> <td>0.5-1.5</td> <td rowspan="4">Flow/Reflow</td> <td rowspan="4">Flow 0.8 Reflow 0.7</td> <td rowspan="4">Flow 2.5 Reflow 2.0</td> <td rowspan="4">Flow 0.7 Reflow 0.7</td> <td>0.7</td> <td>0.7</td> <td>0.7</td> </tr> <tr> <td>1.7-2.5</td> <td>1.2</td> <td>0.7</td> <td>0.7</td> </tr> <tr> <td>3-4</td> <td>2.4</td> <td>1.2</td> <td>0.7</td> </tr> <tr> <td>5-6</td> <td>6.4</td> <td>3.3</td> <td>1.65</td> </tr> <tr> <td><b>BLM18SN_T□1</b></td> <td>8</td> <td></td> <td></td> <td></td> <td></td> <td>-</td> <td>6.4</td> <td>3.3</td> </tr> <tr> <td rowspan="4"><b>BLM18KG_JH1</b> <b>BLM18KG_BH1</b> <b>BLM18AG_BH1</b> <b>BLM18BD_BH1</b></td> <td>1.0max.</td> <td rowspan="2">Flow</td> <td rowspan="2">0.8</td> <td rowspan="2">2.5</td> <td rowspan="4">0.7</td> <td>0.7</td> <td>0.7</td> <td>0.7</td> </tr> <tr> <td>1.5max.</td> <td>1.2</td> <td>0.7</td> <td>0.7</td> </tr> <tr> <td>2.5max.</td> <td rowspan="2">Reflow</td> <td rowspan="2">0.7</td> <td rowspan="2">2.0</td> <td>2.4</td> <td>1.2</td> <td>0.7</td> </tr> <tr> <td>4.0max.</td> <td>6.4</td> <td>3.3</td> <td>1.65</td> </tr> <tr> <td rowspan="4"><b>BLM21PG</b></td> <td>1.5</td> <td rowspan="4">Flow/Reflow</td> <td rowspan="4">Flow 1.1 Reflow 1.2</td> <td rowspan="4">Flow 3.5 Reflow 2.4</td> <td rowspan="4">Flow 0.95 Reflow 1.25</td> <td>1.0</td> <td>1.0</td> <td>1.0</td> </tr> <tr> <td>2</td> <td>1.2</td> <td>1.0</td> <td>1.0</td> </tr> <tr> <td>3-4</td> <td>2.4</td> <td>1.2</td> <td>1.0</td> </tr> <tr> <td>6</td> <td>6.4</td> <td>3.3</td> <td>1.65</td> </tr> <tr> <td rowspan="2"><b>BLM21SN</b></td> <td>6-8.5</td> <td>Flow</td> <td>1.1</td> <td>3.5</td> <td>0.95</td> <td>-</td> <td>6.8</td> <td>3.4</td> </tr> <tr> <td></td> <td>Reflow</td> <td>1.2</td> <td>2.4</td> <td>1.25</td> <td></td> <td></td> <td></td> </tr> <tr> <td rowspan="3"><b>BLM31PG</b></td> <td>1.5-2</td> <td rowspan="3">Flow/Reflow</td> <td rowspan="3">Flow 2.4 Reflow 2</td> <td rowspan="3">Flow 4.7 Reflow 4.3</td> <td rowspan="3">Flow 1.2 Reflow 1.8</td> <td>1.2</td> <td>1.2</td> <td>1.2</td> </tr> <tr> <td>3.5</td> <td>2.4</td> <td>1.2</td> <td>1.2</td> </tr> <tr> <td>6</td> <td>6.4</td> <td>3.3</td> <td>1.65</td> </tr> <tr> <td rowspan="3"><b>BLM31KN_S□1</b></td> <td>2</td> <td rowspan="3">Flow/Reflow</td> <td rowspan="3">Flow 2.4 Reflow 2</td> <td rowspan="3">Flow 4.7 Reflow 4.3</td> <td rowspan="3">Flow 1.2 Reflow 1.8</td> <td>1.2</td> <td>1.2</td> <td>1.2</td> </tr> <tr> <td>2.5-2.9</td> <td>2.4</td> <td>1.2</td> <td>1.2</td> </tr> <tr> <td>4-6</td> <td>6.4</td> <td>3.3</td> <td>1.65</td> </tr> <tr> <td rowspan="3"><b>BLM31KN_B□1</b></td> <td>1.4</td> <td rowspan="3">Flow/Reflow</td> <td rowspan="3">Flow 2.4 Reflow 2</td> <td rowspan="3">Flow 4.7 Reflow 4.3</td> <td rowspan="3">Flow 1.2 Reflow 1.8</td> <td>1.2</td> <td>1.2</td> <td>1.2</td> </tr> <tr> <td>1.7-2.0</td> <td>2.4</td> <td>1.2</td> <td>1.2</td> </tr> <tr> <td>2.7-4</td> <td>6.4</td> <td>3.3</td> <td>1.65</td> </tr> <tr> <td><b>BLM31SN</b></td> <td>10-12</td> <td></td> <td></td> <td></td> <td></td> <td>-</td> <td>9.8</td> <td>4.9</td> </tr> <tr> <td rowspan="3"><b>BLM41PG</b></td> <td>1.5-2</td> <td rowspan="3">Flow/Reflow</td> <td rowspan="3">1.2</td> <td rowspan="3">6.0</td> <td rowspan="3">3.0</td> <td>1.2</td> <td>1.2</td> <td>1.2</td> </tr> <tr> <td>3.5</td> <td>2.4</td> <td>1.2</td> <td>1.2</td> </tr> <tr> <td>6</td> <td>6.4</td> <td>3.3</td> <td>1.65</td> </tr> </tbody> </table>										Type	Rated Current (A)	Soldering	a	b	c	Land Pad Thickness and Dimension d			18μm	35μm	70μm	<b>BLE18PS</b>	8	Flow	0.8	2.5	0.7	-	6.4	3.3	Reflow	0.7	2.0	-	-	-	<b>BLE32PN</b>	10	Flow/Reflow	2.2	4.4	2.05	-	4.0 (Temperature 85°C or less)	-	-	8.0 (Temperature 125°C or less)	-	<b>BLM03AX</b> <b>BLM03P□</b> <b>BLM03EB</b>	0.9max.	Reflow	0.25	0.8	0.3	0.3	0.3	0.3	1.8max.	1.2	0.7	0.3					<b>BLM15AX</b> <b>BLM15PD</b> <b>BLM15PG</b> <b>BLM15PX</b>	1.5max.	Reflow	0.4	1.2	0.5	0.5	0.5	0.5	2.2max.	1.2	0.7	0.5		2.4	1.2	0.5	3.0max.				<b>BLM18PG_S□1</b> <b>BLM18KG_S□1</b> <b>BLM18KG_T□1</b> <b>BLM18SG_T□1</b>	0.5-1.5	Flow/Reflow	Flow 0.8 Reflow 0.7	Flow 2.5 Reflow 2.0	Flow 0.7 Reflow 0.7	0.7	0.7	0.7	1.7-2.5	1.2	0.7	0.7	3-4	2.4	1.2	0.7	5-6	6.4	3.3	1.65	<b>BLM18SN_T□1</b>	8					-	6.4	3.3	<b>BLM18KG_JH1</b> <b>BLM18KG_BH1</b> <b>BLM18AG_BH1</b> <b>BLM18BD_BH1</b>	1.0max.	Flow	0.8	2.5	0.7	0.7	0.7	0.7	1.5max.	1.2	0.7	0.7	2.5max.	Reflow	0.7	2.0	2.4	1.2	0.7	4.0max.	6.4	3.3	1.65	<b>BLM21PG</b>	1.5	Flow/Reflow	Flow 1.1 Reflow 1.2	Flow 3.5 Reflow 2.4	Flow 0.95 Reflow 1.25	1.0	1.0	1.0	2	1.2	1.0	1.0	3-4	2.4	1.2	1.0	6	6.4	3.3	1.65	<b>BLM21SN</b>	6-8.5	Flow	1.1	3.5	0.95	-	6.8	3.4		Reflow	1.2	2.4	1.25				<b>BLM31PG</b>	1.5-2	Flow/Reflow	Flow 2.4 Reflow 2	Flow 4.7 Reflow 4.3	Flow 1.2 Reflow 1.8	1.2	1.2	1.2	3.5	2.4	1.2	1.2	6	6.4	3.3	1.65	<b>BLM31KN_S□1</b>	2	Flow/Reflow	Flow 2.4 Reflow 2	Flow 4.7 Reflow 4.3	Flow 1.2 Reflow 1.8	1.2	1.2	1.2	2.5-2.9	2.4	1.2	1.2	4-6	6.4	3.3	1.65	<b>BLM31KN_B□1</b>	1.4	Flow/Reflow	Flow 2.4 Reflow 2	Flow 4.7 Reflow 4.3	Flow 1.2 Reflow 1.8	1.2	1.2	1.2	1.7-2.0	2.4	1.2	1.2	2.7-4	6.4	3.3	1.65	<b>BLM31SN</b>	10-12					-	9.8	4.9	<b>BLM41PG</b>	1.5-2	Flow/Reflow	1.2	6.0	3.0	1.2	1.2	1.2	3.5	2.4	1.2	1.2	6	6.4	3.3	1.65
	Type	Rated Current (A)	Soldering	a	b	c	Land Pad Thickness and Dimension d																																																																																																																																																																																																																																																									
							18μm	35μm	70μm																																																																																																																																																																																																																																																							
<b>BLE18PS</b>	8	Flow	0.8	2.5	0.7	-	6.4	3.3																																																																																																																																																																																																																																																								
		Reflow	0.7	2.0		-	-	-																																																																																																																																																																																																																																																								
<b>BLE32PN</b>	10	Flow/Reflow	2.2	4.4	2.05	-	4.0 (Temperature 85°C or less)	-																																																																																																																																																																																																																																																								
						-	8.0 (Temperature 125°C or less)	-																																																																																																																																																																																																																																																								
<b>BLM03AX</b> <b>BLM03P□</b> <b>BLM03EB</b>	0.9max.	Reflow	0.25	0.8	0.3	0.3	0.3	0.3																																																																																																																																																																																																																																																								
	1.8max.					1.2	0.7	0.3																																																																																																																																																																																																																																																								
<b>BLM15AX</b> <b>BLM15PD</b> <b>BLM15PG</b> <b>BLM15PX</b>	1.5max.	Reflow	0.4	1.2	0.5	0.5	0.5	0.5																																																																																																																																																																																																																																																								
	2.2max.					1.2	0.7	0.5																																																																																																																																																																																																																																																								
						2.4	1.2	0.5																																																																																																																																																																																																																																																								
	3.0max.																																																																																																																																																																																																																																																															
<b>BLM18PG_S□1</b> <b>BLM18KG_S□1</b> <b>BLM18KG_T□1</b> <b>BLM18SG_T□1</b>	0.5-1.5	Flow/Reflow	Flow 0.8 Reflow 0.7	Flow 2.5 Reflow 2.0	Flow 0.7 Reflow 0.7	0.7	0.7	0.7																																																																																																																																																																																																																																																								
	1.7-2.5					1.2	0.7	0.7																																																																																																																																																																																																																																																								
	3-4					2.4	1.2	0.7																																																																																																																																																																																																																																																								
	5-6					6.4	3.3	1.65																																																																																																																																																																																																																																																								
<b>BLM18SN_T□1</b>	8					-	6.4	3.3																																																																																																																																																																																																																																																								
<b>BLM18KG_JH1</b> <b>BLM18KG_BH1</b> <b>BLM18AG_BH1</b> <b>BLM18BD_BH1</b>	1.0max.	Flow	0.8	2.5	0.7	0.7	0.7	0.7																																																																																																																																																																																																																																																								
	1.5max.					1.2	0.7	0.7																																																																																																																																																																																																																																																								
	2.5max.	Reflow	0.7	2.0		2.4	1.2	0.7																																																																																																																																																																																																																																																								
	4.0max.					6.4	3.3	1.65																																																																																																																																																																																																																																																								
<b>BLM21PG</b>	1.5	Flow/Reflow	Flow 1.1 Reflow 1.2	Flow 3.5 Reflow 2.4	Flow 0.95 Reflow 1.25	1.0	1.0	1.0																																																																																																																																																																																																																																																								
	2					1.2	1.0	1.0																																																																																																																																																																																																																																																								
	3-4					2.4	1.2	1.0																																																																																																																																																																																																																																																								
	6					6.4	3.3	1.65																																																																																																																																																																																																																																																								
<b>BLM21SN</b>	6-8.5	Flow	1.1	3.5	0.95	-	6.8	3.4																																																																																																																																																																																																																																																								
		Reflow	1.2	2.4	1.25																																																																																																																																																																																																																																																											
<b>BLM31PG</b>	1.5-2	Flow/Reflow	Flow 2.4 Reflow 2	Flow 4.7 Reflow 4.3	Flow 1.2 Reflow 1.8	1.2	1.2	1.2																																																																																																																																																																																																																																																								
	3.5					2.4	1.2	1.2																																																																																																																																																																																																																																																								
	6					6.4	3.3	1.65																																																																																																																																																																																																																																																								
<b>BLM31KN_S□1</b>	2	Flow/Reflow	Flow 2.4 Reflow 2	Flow 4.7 Reflow 4.3	Flow 1.2 Reflow 1.8	1.2	1.2	1.2																																																																																																																																																																																																																																																								
	2.5-2.9					2.4	1.2	1.2																																																																																																																																																																																																																																																								
	4-6					6.4	3.3	1.65																																																																																																																																																																																																																																																								
<b>BLM31KN_B□1</b>	1.4	Flow/Reflow	Flow 2.4 Reflow 2	Flow 4.7 Reflow 4.3	Flow 1.2 Reflow 1.8	1.2	1.2	1.2																																																																																																																																																																																																																																																								
	1.7-2.0					2.4	1.2	1.2																																																																																																																																																																																																																																																								
	2.7-4					6.4	3.3	1.65																																																																																																																																																																																																																																																								
<b>BLM31SN</b>	10-12					-	9.8	4.9																																																																																																																																																																																																																																																								
<b>BLM41PG</b>	1.5-2	Flow/Reflow	1.2	6.0	3.0	1.2	1.2	1.2																																																																																																																																																																																																																																																								
	3.5					2.4	1.2	1.2																																																																																																																																																																																																																																																								
	6					6.4	3.3	1.65																																																																																																																																																																																																																																																								
• About land pad thickness of BLE32PN, please note the upper limit of the temperature. • Do not apply narrower pattern than listed above to BLMppAX/P/K/S. Narrow pattern can cause excessive heat or open circuit.																																																																																																																																																																																																																																																																

## Chip Ferrite Bead (BL□ Series) Soldering and Mounting

Continued from the preceding page. ↘

### ● PCB Warping

PCB should be designed so that products are not subjected to the mechanical stress caused by warping the board.

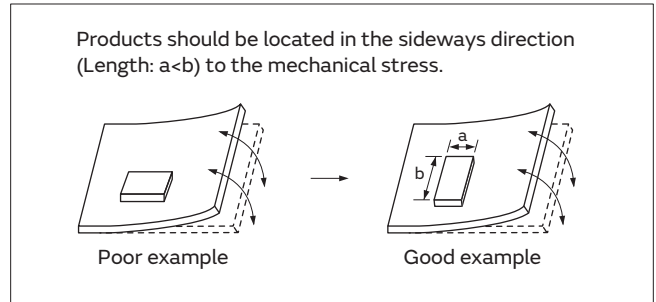

### 2. Solder Paste Printing and Adhesive Application

When reflow soldering the chip ferrite beads and bead inductor the printing must be conducted in accordance with the following cream solder printing conditions. If too much solder is applied, the chip will be prone to

damage by mechanical and thermal stress from the PCB and may crack. Standard land dimensions should be used for resist and copper foil patterns.

(in mm)

Series	Solder Paste Printing
BLM BLE	<ul style="list-style-type: none"> <li>● Ensure that solder is applied smoothly to a minimum height of 0.2mm to 0.3mm at the end surface of the part.</li> <li>● Guideline of solder paste thickness:                      100-150μm: BLM03                      100-200μm: BLM15/18/21/31/41/BLE18/32</li> </ul>

### 3. Standard Soldering Conditions

#### (1) Soldering Methods

Use flow and reflow soldering methods only.  
 Use standard soldering conditions when soldering chip ferrite beads and bead inductor.  
 In cases where several different parts are soldered, each having different soldering conditions, use those conditions requiring the least heat and minimum time.

Solder: Use Sn-3.0Ag-0.5Cu solder. Use of Sn-Zn based solder will deteriorate performance of products. If using BLA series with Sn-Zn based solder, please contact Murata in advance.

#### Flux:

- Use Rosin-based flux.  
 In case of using RA type solder, products should be cleaned completely with no residual flux.
- Do not use strong acidic flux (with chlorine content exceeding 0.20wt%)
- Do not use water-soluble flux.

For additional mounting methods, please contact Murata.

Continued on the following page. ↗

## Chip Ferrite Bead (BL□ Series) Soldering and Mounting

Continued from the preceding page. ↘

### (2) Soldering Profile

#### ● Flow Soldering Profile (Sn-3.0Ag-0.5Cu Solder)

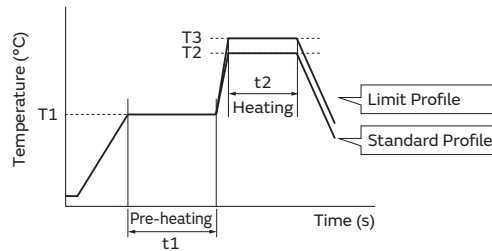

Series	Pre-heating		Standard Profile			Limit Profile		
	Temp. (T1)	Time. (t1)	Heating		Cycle of Flow	Heating		Cycle of Flow
			Temp. (T2)	Time. (t2)		Temp. (T3)	Time. (t2)	
<b>BLM</b> (Except for BLM03/15/18G/18AG_W/31KN) <b>BLE</b>	150°C	60s min.	250°C	4 to 6s	2 times max.	265±3°C	5s max.	2 times max.

#### ● Reflow Soldering Profile (Sn-3.0Ag-0.5Cu Solder)

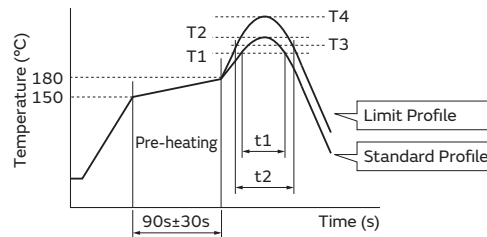

Series	Standard Profile				Limit Profile			
	Heating		Peak Temperature (T2)	Cycle of Reflow	Heating		Peak Temperature (T4)	Cycle of Reflow
	Temp. (T1)	Time. (t1)			Temp. (T3)	Time. (t2)		
<b>BLM</b> (Except for BLM18AG_W) <b>BLE</b>	220°C min.	30 to 60s	245±3°C	2 times max.	230°C min.	60s max.	260°C/10s	2 times max.

### (3) Reworking with Solder Iron

The following conditions must be strictly followed when using a soldering iron.

Pre-heating: 150°C 60s min.

Soldering iron power output / Tip diameter:  
 80W max. / ø3mm max.

Temperature of soldering iron tip / Soldering time / Times:

350°C max. / 3-4s / 2 times

Do not allow the tip of the soldering iron to directly contact the chip.

For additional methods of reworking with a soldering iron, please contact Murata engineering.

Continued on the following page. ↗

## Chip Ferrite Bead (BL□ Series) Soldering and Mounting

Continued from the preceding page. ↘

### 4. Mounting on-board with Conductive Glue of BLM18AG□□□WH1

Please adhere rigidly to the condition below which shows the method of mounting with conductive glue.  
 Please coat print pads with conductive glue using metal mask and metal squeegee, and then mount our products on the substrates with a mount machine or human hand.  
 Please put the substrates into an oven (140 to 150°C) for 30 minutes in order to cure the adhesive.  
 Please check whether the chips and the substrates are connected with the conductive glue or not and there is no electrical short of the conductive glue.

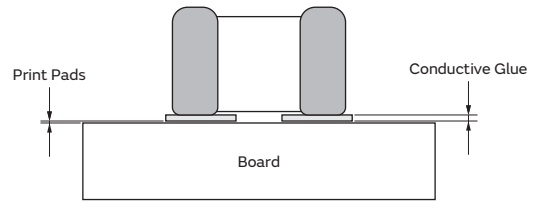

1. Board	Ceramic Board or Alumina Board
2. Thickness of Glue	30 to 50μm
3. Recommended Conductive Glue	PC3000 (Manufactured by Heraeus)

### 5. Cleaning

Following conditions should be observed when cleaning chip ferrite beads.

- (1) Cleaning Temperature: 60°C max. (40°C max. for alcohol type cleaner)
- (2) Ultrasonic
  - Output: 20W/liter max.
  - Duration: 5 minutes max.
  - Frequency: 28 to 40kHz
- (3) Cleaning Agent

The following list of cleaning agents have been tested on the individual components. Evaluation of final assembly should be completed prior to production.

Do not clean BLM18AG□□□WH1 series. Before cleaning, please contact Murata engineering.

- (a) Alcohol cleaning agent
  - Isopropyl alcohol (IPA)
- (b) Aqueous cleaning agent
  - Pine Alpha ST-100S

- (4) Ensure that flux residue is completely removed. Component should be thoroughly dried after aqueous agent has been removed with deionized water.
- (5) BLM□□G type is processed with resin. On rinsing the product, using water for ultrasonic cleaning may affect the resin quality used for the product by water element. In case of set cleaning conditions, please make sure the reliability according to the cleaning conditions.

For additional cleaning methods, please contact Murata engineering.

## Chip Ferrite Bead (BL□ Series) Packaging

### Minimum Quantity and Dimensions of 8mm Width Paper / Embossed Tape

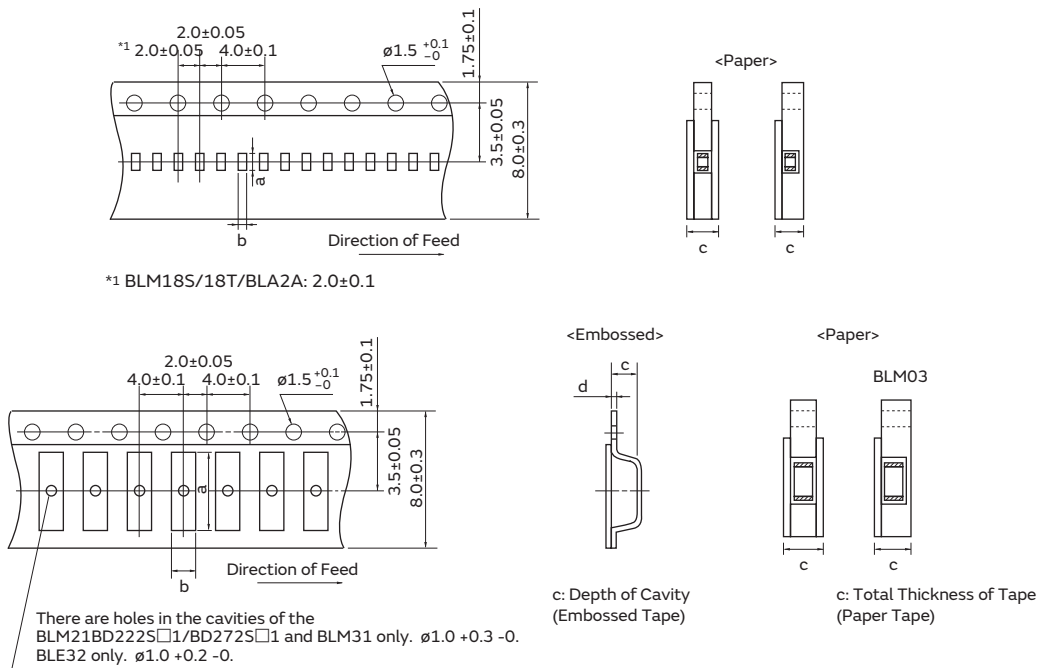

Dimension of the cavity of embossed tape is measured at the bottom side.

Part Number	Dimensions				Minimum Qty. (pcs.)				
					ø180mm Reel		ø330mm Reel		Bulk
	a	b	c	d	Paper Tape	Embossed Tape	Paper Tape	Embossed Tape	
BLM03	0.70 (except 03H/03E)	0.40 (except 03H/03E)	0.55 max.	-	15000	-	50000	-	1000
BLM15	1.15	0.65	0.8 max.	-	10000	-	50000	-	1000
BLM18A/B/P/H/G	1.85	1.05	1.1 max. (except JH/TH/TZ)	-	4000	-	10000	-	1000
BLM18EG/KG_T□	1.85	1.05	0.85 max.	-	4000	-	10000	-	1000
BLM18EG/KG_S□			1.1 max.						
BLM18S	1.85	1.05	0.90 max.	-	10000	-	30000	-	1000
BLM21	2.25	1.45	1.1 max.	-	4000	-	10000	-	1000
BLM31	3.5	1.9	1.3	0.2	-	3000	-	10000	1000
BLM21BD222S□1/BD272S□1	2.25	1.45	1.3	0.2	-	3000	-	10000	1000
BLE18PS080S□1	1.85	1.05	0.85	-	4000	-	10000	-	1000
BLE32PN260S□1	3.5	2.8	1.75	0.25	-	1500	-	7000	1000
BLE32PN300S□1			2.3						
BLM31KN_S□1/B□1	3.5	1.9	1.75	0.2	-	2500	-	8000	1000

- BLM03H/03E. Dimensions a: 0.66, b: 0.36.
- BLM18\_JH/TH/TZ. Dimensions c: 0.85 max.

(in mm)

### Minimum Quantity and Dimensions of 12mm Width Embossed Tape

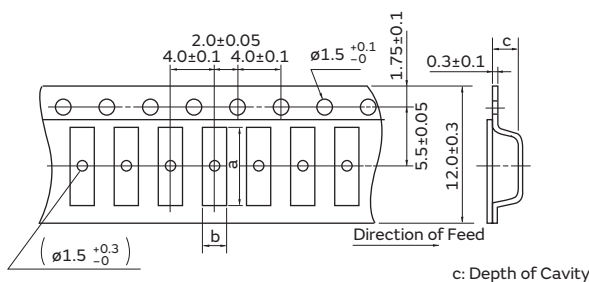

Part Number	Dimensions			Minimum Qty. (pcs.)		
	a	b	c	ø180mm Reel	ø330mm Reel	Bulk
BLM41	4.8	1.9	1.75	2500	8000	1000

(in mm)

"Minimum Quantity" means the number of units of each delivery or order. The quantity should be an integral multiple of the "Minimum Quantity."

SMD Type  
 Chip Ferrite Bead

SMD Type  
 Chip EMIFIL®

SMD Type  
 Chip Common Mode Choke Coil

SMD Type  
 Block Type EMIFIL®

Lead Type  
 EMI Suppression Filters

SMD Type  
 Microchip Transformer (Balun)

● Part Numbering

Chip EMIFIL® for Automotive LC Combined

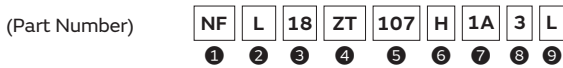

① Product ID

Product ID	
NF	Chip EMIFIL®

② Structure

Code	Structure
L	Multilayer, LC Combined Type
E	Block, LC Combined Type

③ Dimensions (LxW)

Code	Dimensions (LxW)	Size Code (inch)
18	1.6x0.8mm	0603
31	3.2x1.6mm	1206
61	6.8x1.6mm	2706

④ Features

Code	Features	
HT	For Automotive	Powertrain, Safety, T Circuit
ZT		Infotainment, T Circuit

⑤ Cut-off Frequency (NFL Series)

Expressed by three figures. The unit is in hertz (Hz). The first and second figures are significant digits, and the third figure expresses the number of zeros that follow the two figures.

⑥ Capacitance (NFE Series)

Expressed by three figures. The unit is in pico-farad (pF). The first and second figures are significant digits, and the third figure expresses the number of zeros that follow the two figures.

⑨ Packaging

Code	Packaging	Series
K	Embossed Taping (ø330mm Reel)	NFE
L	Embossed Taping (ø180mm Reel)	NFE
B	Bulk	NFL18/NFE
D	Paper Taping (ø180mm Reel)	NFL18

⑥ Characteristics (NFL Series)

Code	Characteristics
H	Cut-off Frequency

⑥ Characteristics (NFE Series)

Code	Capacitance Temperature Characteristics
C	±20%, ±22%
D	+20/-30%, +22/-33%
F	+30/-80%, +22/-82%
R	±15%
U	-750 ±120ppm/ °C
Z	Other

⑦ Rated Voltage

Code	Rated Voltage
1A	10V
1E	25V
2A	100V

⑧ Electrode

Code	Electrode	Series
3	Sn Plating	NFL
9	Others	NFE

### Chip EMIFIL<sup>®</sup> for Automotive

(Part Number) 

NF	Z	32	BW	3R6	H	Z	1	0	L
1	2	3	4	5	6	7	8	9	10

#### 1 Product ID

Product ID	
NF	Chip EMIFIL <sup>®</sup>

#### 2 Structure

Code	Structure
Z	Inductor Type

#### 3 Dimensions (LxW)

Code	Dimensions (LxW)	Size Code (inch)
18	1.6x0.8mm	0603
32	3.2x2.5mm	1210
5B	5.0x5.0mm	2020

#### 4 Features

Code	Features
SM	For Audio Lines Multilayer Type
BW	For LED Lines Wire Wound Type

#### 5 Impedance

Expressed by three figures. The unit is in ohm ( $\Omega$ ). The first and second figures are significant digits, and the third figure expresses the number of zeros that follow the two figures.

#### 6 Inductance Tolerance

Code	Features
S	For General Use (Sn Plating)
H	For General Use (LF Solder) *1
L	For General Use (LF Solder)

\*1 NFZ32BW\_H□1 only.

#### 7 Category

Code	Category	
Z	For Automotive	Infotainment

#### 8 Number of Circuits

Code	Number of Circuits
1	1 Circuit

#### 9 Specification

Code	Specification
0	Standard Type
1	Low Rdc Type

#### 10 Packaging

Code	Packaging	Series
K	Embossed Taping ( $\phi$ 330mm Reel)	NFZ32/5B
L	Embossed Taping ( $\phi$ 180mm Reel)	NFZ32/5B
B	Bulk	NFZ18
D	Paper Taping ( $\phi$ 180mm Reel)	NFZ18

SMD Type  
Chip Ferrite Bead

SMD Type  
Chip EMIFIL<sup>®</sup>

SMD Type  
Chip Common Mode Choke Coil

SMD Type  
Block Type EMIFIL<sup>®</sup>

Lead Type  
EMI Suppression Filters

SMD Type  
Microchip Transformer (Balun)

# Feed Through Chip EMI Filters SMD Type

## NFE31ZT Series 1206/3216(inch/mm)

### Appearance/Dimensions

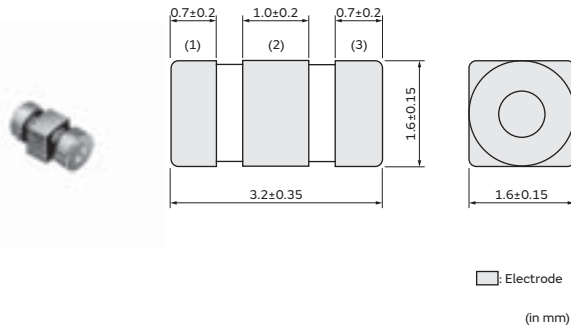

### Packaging

Code	Packaging	Minimum Quantity
L	ø180mm Embossed Taping	2000
K	ø330mm Embossed Taping	8000
B	Packing in Bulk	500

### Equivalent Circuit

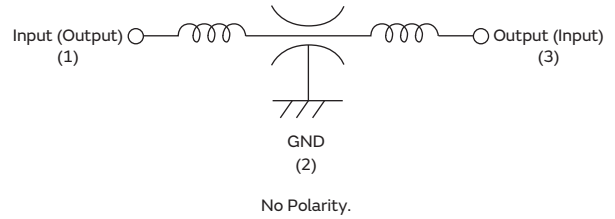

### Rated Value (□: packaging code)

Part Number		Capacitance	Rated Current	Rated Voltage	Insulation Resistance (min.)	Operating Temperature Range
For Infotainment	For Powertrain/Safety					
NFE31ZT220R1E9□	—	22pF ±30%	6A	25Vdc	1000MΩ	-40°C to +85°C
NFE31ZT470C1E9□	—	47pF 50/-20%	6A	25Vdc	1000MΩ	-40°C to +85°C
NFE31ZT101C1E9□	—	100pF 80/-20%	6A	25Vdc	1000MΩ	-40°C to +85°C
NFE31ZT221D1E9□	—	220pF 50/-20%	6A	25Vdc	1000MΩ	-40°C to +85°C
NFE31ZT471F1E9□	—	470pF 50/-20%	6A	25Vdc	1000MΩ	-40°C to +85°C
NFE31ZT152Z1E9□	—	1500pF 50/-20%	6A	25Vdc	1000MΩ	-40°C to +85°C
NFE31ZT222Z1E9□	—	2200pF ±50%	6A	25Vdc	1000MΩ	-40°C to +85°C

Number of Circuits: 1

### Insertion Loss Characteristics (Main Items)

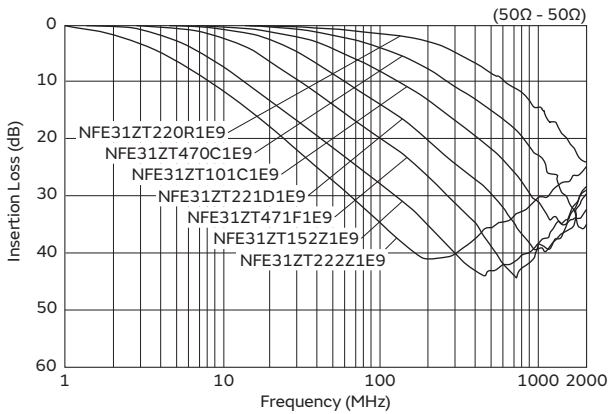



# Feed Through Chip EMI Filters SMD Type

## NFE61HT Series 2706/6816(inch/mm)

### Appearance/Dimensions

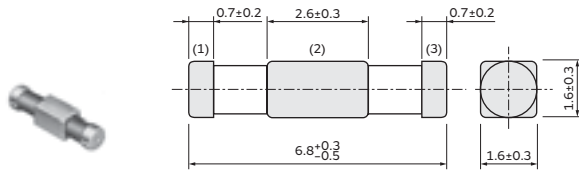

(in mm)

### Packaging

Code	Packaging	Minimum Quantity
L	ø180mm Embossed Taping	2500
K	ø330mm Embossed Taping	8000
B	Packing in Bulk	500

### Equivalent Circuit

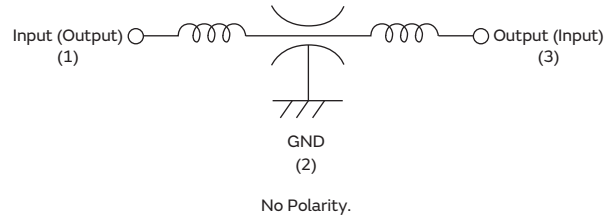

### Rated Value (□: packaging code)

Part Number		Capacitance	Rated Current	Rated Voltage	Insulation Resistance (min.)	Operating Temperature Range
For Infotainment	For Powertrain/Safety					
—	NFE61HT330U2A9□	33pF ±30%	2A	100Vdc	1000MΩ	-55°C to +125°C
—	NFE61HT680R2A9□	68pF ±30%	2A	100Vdc	1000MΩ	-55°C to +125°C
—	NFE61HT101Z2A9□	100pF ±30%	2A	100Vdc	1000MΩ	-55°C to +125°C
—	NFE61HT181C2A9□	180pF ±30%	2A	100Vdc	1000MΩ	-55°C to +125°C
—	NFE61HT361C2A9□	360pF ±20%	2A	100Vdc	1000MΩ	-55°C to +125°C
—	NFE61HT681D2A9□	680pF ±30%	2A	100Vdc	1000MΩ	-55°C to +125°C
—	NFE61HT102F2A9□	1000pF 80/-20%	2A	100Vdc	1000MΩ	-55°C to +125°C
—	NFE61HT332Z2A9□	3300pF 80/-20%	2A	100Vdc	1000MΩ	-55°C to +125°C

Number of Circuit: 1

### Insertion Loss Characteristics (Main Items)

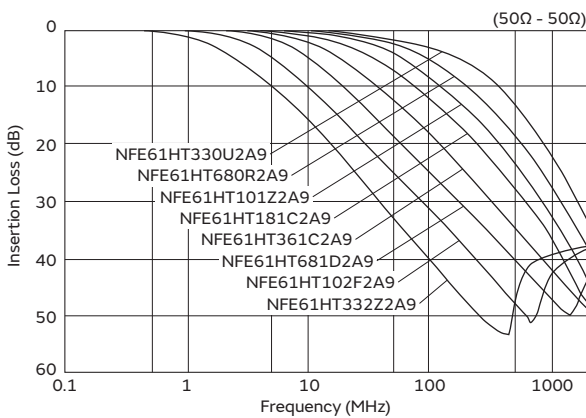

SMD Type  
 Chip Ferrite Bead

SMD Type  
 Chip EMIFIL®

SMD Type  
 Chip Common Mode Choke Coil

SMD Type  
 Block Type EMIFIL®

Lead Type  
 Leaded Multilayer Ferrite Beads

SMD Type  
 Microchip Transformer (Balun)

# LC Combined Filters (Multilayer Type) SMD Type

## NFL18ZT Series 0603/1608(inch/mm)

### Appearance/Dimensions

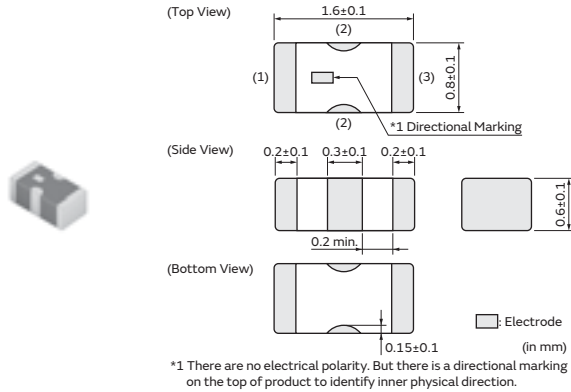

### Packaging

Code	Packaging	Minimum Quantity
D	ø180mm Paper Taping	4000
B	Packing in Bulk	1000

### Equivalent Circuit

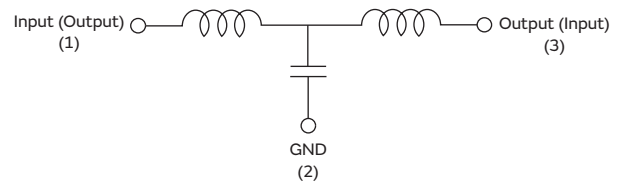

No Polarity.

### Rated Value (□: packaging code)

Part Number		Nominal Cut-off Frequency	Capacitance	Inductance	Rated Current	Rated Voltage	Insulation Resistance (min.)	Withstand Voltage
For Infotainment	For Powertrain/Safety							
NFL18ZT506H1A3□	—	50MHz	110pF (Typ.)	350nH (Typ.)	75mA	10Vdc	1000MΩ	30Vdc
NFL18ZT706H1A3□	—	70MHz	70pF (Typ.)	230nH (Typ.)	75mA	10Vdc	1000MΩ	30Vdc
NFL18ZT107H1A3□	—	100MHz	50pF (Typ.)	150nH (Typ.)	75mA	10Vdc	1000MΩ	30Vdc
NFL18ZT207H1A3□	—	200MHz	22pF (Typ.)	110nH (Typ.)	100mA	10Vdc	1000MΩ	30Vdc
NFL18ZT307H1A3□	—	300MHz	16pF (Typ.)	74nH (Typ.)	100mA	10Vdc	1000MΩ	30Vdc
NFL18ZT507H1A3□	—	500MHz	10pF (Typ.)	42nH (Typ.)	100mA	10Vdc	1000MΩ	30Vdc

Number of Circuit: 1 Operating Temperature Range: -55°C to +125°C

### Insertion Loss Characteristics (Main Items)

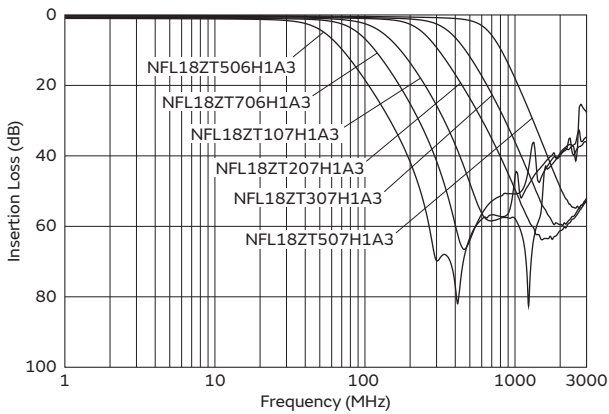

Chip Ferrite Bead SMD Type  
 Chip EMIFIL® SMD Type  
 Chip Common Mode Choke Coil SMD Type  
 Block Type EMIFIL® SMD Type  
 Leaded Multilayer Ferrite Beads Lead Type  
 Microchip Transformer (Balun) SMD Type

# Impedance Type Filters SMD Type

## NFZ18SM\_10 Series 0603/1608(inch/mm)

### Appearance/Dimensions

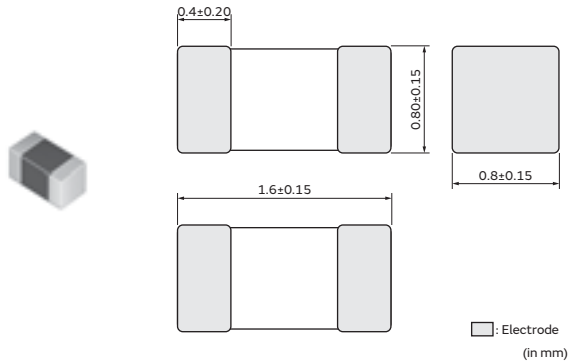

### Packaging

Code	Packaging	Minimum Quantity
D	ø180mm Paper Tape	4000
B	Bulk(Bag)	1000

### Equivalent Circuit



(Resistance element becomes dominant at high frequencies.)

### Rated Value (□: packaging code)

Part Number		Impedance at 100MHz	Rated Current	DC Resistance	DC Resistance (Max.)
Infotainment	Powertrain/Safety				
NFZ18SM121SZ10□	—	120Ω±25%	1.25A	0.11Ω (Typ.)	0.14Ω
NFZ18SM251SZ10□	—	250Ω±25%	1.1A	0.15Ω (Typ.)	0.19Ω
NFZ18SM501SZ10□	—	500Ω±25%	950mA	0.20Ω (Typ.)	0.25Ω
NFZ18SM701SZ10□	—	700Ω±25%	800mA	0.23Ω (Typ.)	0.29Ω

Operating Temp. Range: -55°C to 125°C

### Z-f Characteristics: NFZ18SM\_10 Series

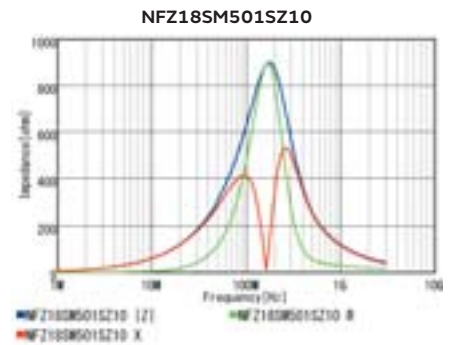
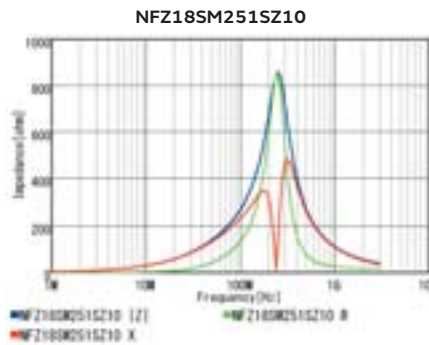
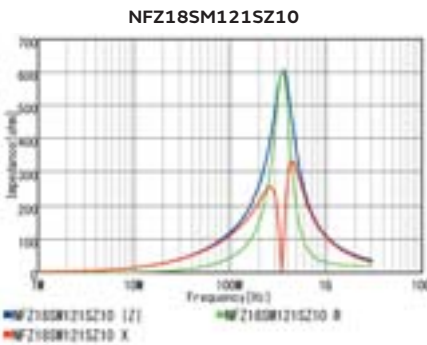
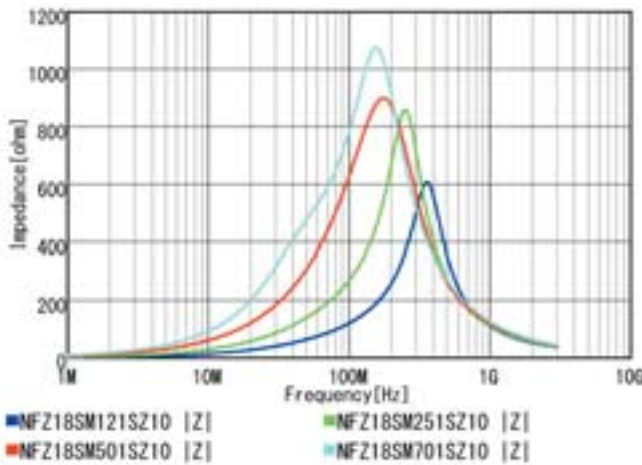

Continued on the following page. ↗

SMD Type  
 Chip Ferrite Bead

SMD Type  
 Chip EMIFIL®

SMD Type  
 Chip Common Mode Choke Coil

SMD Type  
 Block Type EMIFIL®

Lead Type  
 EMI Suppression Filters

SMD Type  
 Microchip Transformer (Balun)

Continued from the preceding page. ↘

## Z-f characteristics

NFZ18SM701SZ10

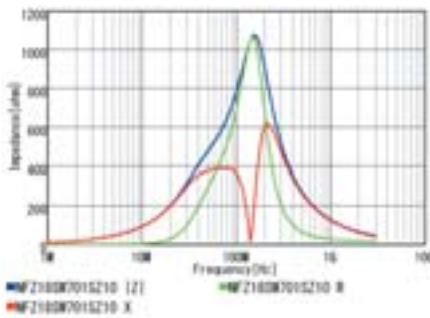

## Derating of Rated Current

In operating temperature exceeding +85°C, derating of current is necessary for NFZ18SM series.  
 Please apply the derating curve shown in chart according to the operating temperature.

Derating of Rated Current

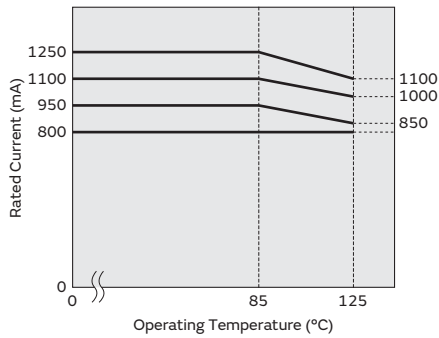

# Impedance Type Filters SMD Type

## NFZ32BW\_10 Series 1210/3225(inch/mm)

### Appearance/Dimensions

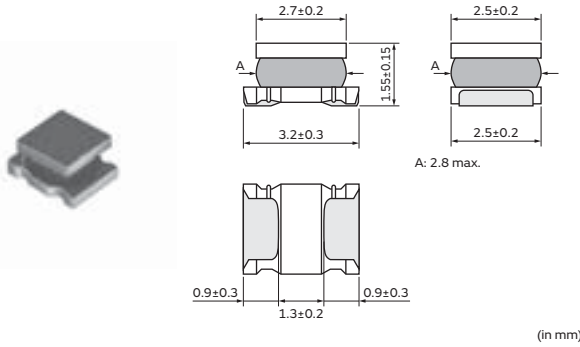

### Packaging

Code	Packaging	Minimum Quantity
K	ø330mm Embossed Tape	7500
L	ø180mm Embossed Tape	2000

### Equivalent Circuit



(Resistance element becomes dominant at high frequencies.)

### Rated Value (□: packaging code)

Part Number		Impedance at 1MHz	Rated Current	DC Resistance
Infotainment	Powertrain/Safety			
NFZ32BW3R6HZ10□	—	3.6Ω±30%	2.55A	0.03Ω±20%
NFZ32BW7R4HZ10□	—	7.4Ω±30%	2.05A	0.045Ω±20%
NFZ32BW9R0HZ10□	—	9Ω±30%	1.75A	0.057Ω±20%
NFZ32BW150HZ10□	—	15Ω±30%	1.6A	0.076Ω±20%
NFZ32BW210HZ10□	—	21Ω±30%	1.2A	0.12Ω±20%
NFZ32BW320HZ10□	—	32Ω±30%	1A	0.18Ω±20%
NFZ32BW420HZ10□	—	42Ω±30%	850mA	0.24Ω±20%
NFZ32BW700HZ10□	—	70Ω±30%	700mA	0.38Ω±20%
NFZ32BW111HZ10□	—	110Ω±30%	520mA	0.57Ω±20%
NFZ32BW151HZ10□	—	150Ω±30%	450mA	0.81Ω±20%
NFZ32BW221HZ10□	—	220Ω±30%	390mA	1.15Ω±20%
NFZ32BW291HZ10□	—	290Ω±30%	310mA	1.78Ω±20%
NFZ32BW451HZ10□	—	450Ω±30%	275mA	2.28Ω±20%
NFZ32BW621HZ10□	—	620Ω±30%	250mA	2.7Ω±20%
NFZ32BW881HZ10□	—	880Ω±30%	200mA	4.38Ω±20%

Operating Temp. Range: -40°C to 105°C

Operating Temp. Range self-temp. rise included: -40°C to 125°C

### Z-f Characteristics: NFZ32BW\_10 Series

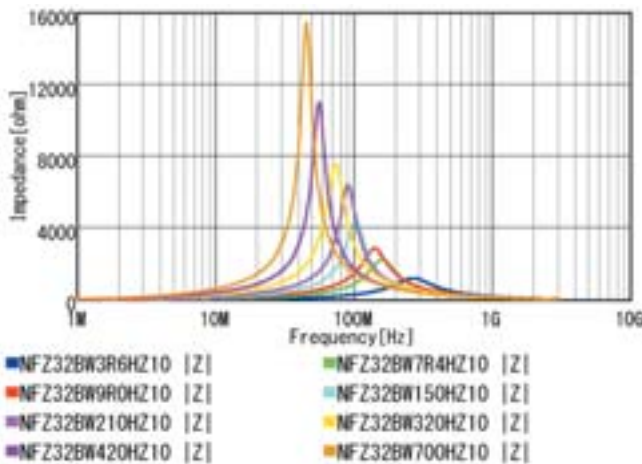

### Z-f Characteristics: NFZ32BW\_10 Series

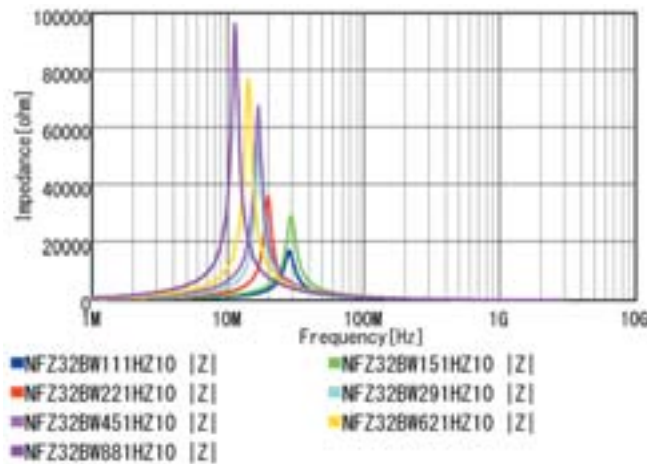

Continued on the following page. ↗

SMD Type  
 Chip Ferrite Bead

SMD Type  
 Chip EMIFIL®

SMD Type  
 Chip Common Mode Choke Coil

SMD Type  
 Block Type EMIFIL®

Lead Type  
 EMI Suppression Filters

SMD Type  
 Microchip Transformer (Balun)

Continued from the preceding page. ↘

**Z-f characteristics**

**NFZ32BW3R6HZ10**

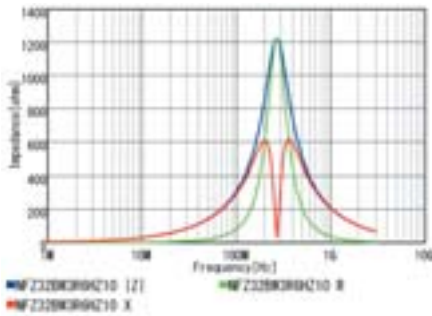

**NFZ32BW7R4HZ10**

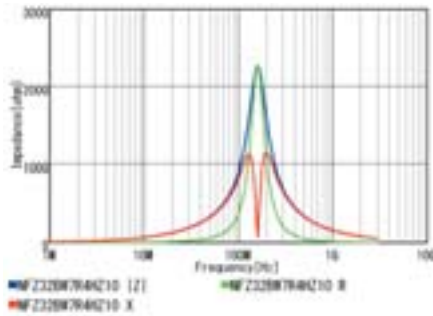

**NFZ32BW9R0HZ10**

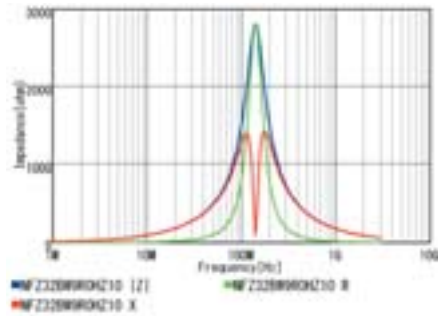

**NFZ32BW150HZ10**

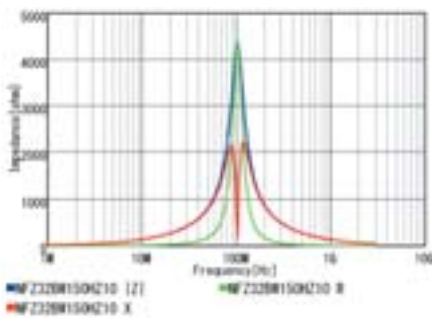

**NFZ32BW210HZ10**

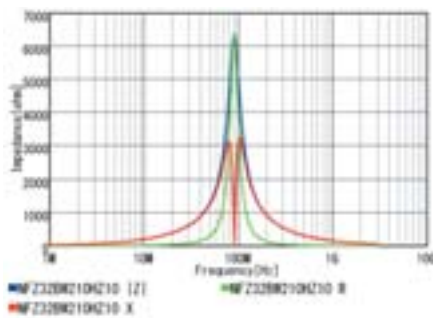

**NFZ32BW320HZ10**

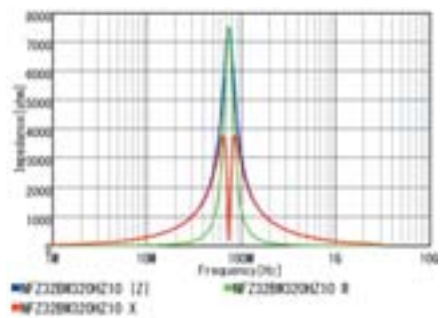

**NFZ32BW420HZ10**

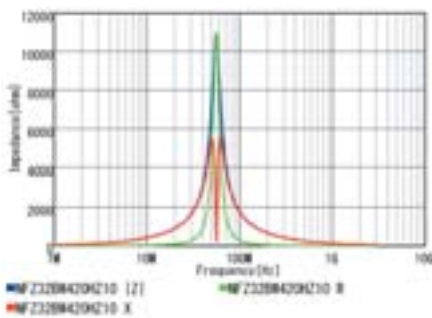

**NFZ32BW700HZ10**

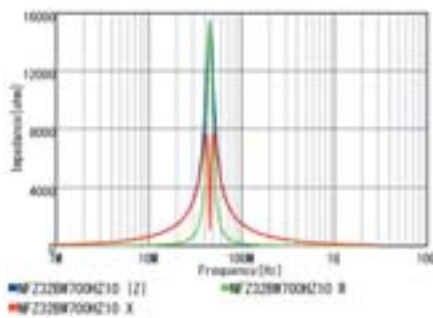

**NFZ32BW111HZ10**

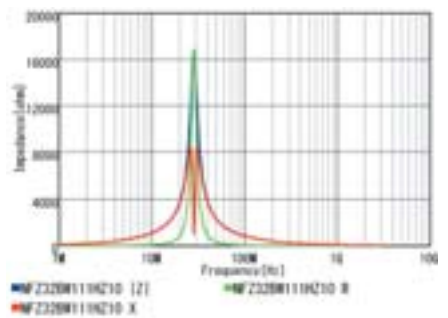

**NFZ32BW151HZ10**

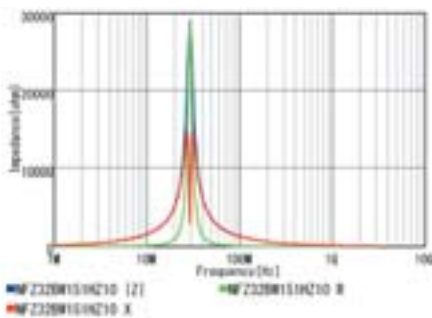

**NFZ32BW221HZ10**

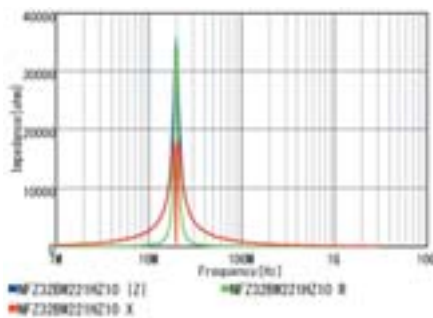

**NFZ32BW291HZ10**

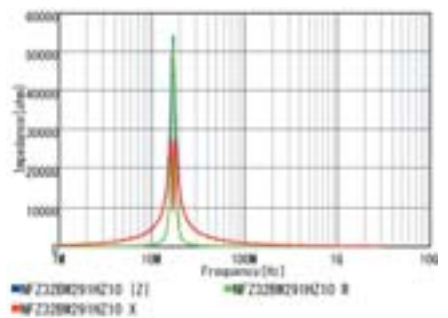

Continued on the following page. ↗

Chip Ferrite Bead SMD Type  
 Chip EMIFIL® SMD Type  
 Chip Common Mode Choke Coil SMD Type  
 Block Type EMIFIL® SMD Type  
 EMI Suppression Filters Lead Type  
 Microchip Transformer (Balun) SMD Type

Continued from the preceding page. ↘

## Z-f characteristics

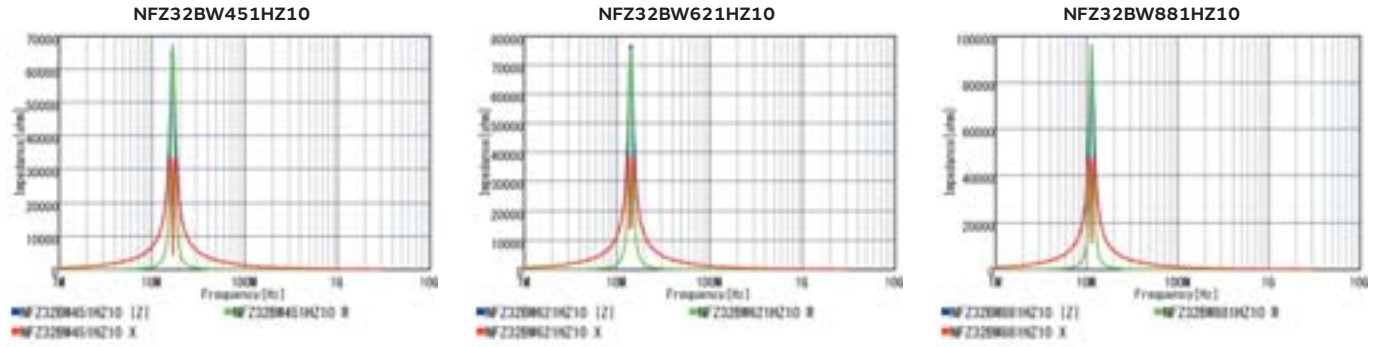

## Derating of Rated Current

In operating temperature exceeding +85°C, derating of current is necessary for NFZ32BW\_H□10 series. Please apply the derating curve shown in chart according to the operating temperature.

Derating of Rated Current

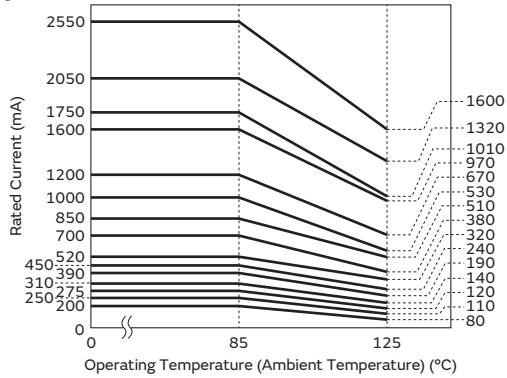

SMD Type  
 Chip Ferrite Bead

SMD Type  
 Chip EMIFIL®

SMD Type  
 Chip Common Mode Choke Coil

SMD Type  
 Block Type EMIFIL®

Lead Type  
 EMI Suppression Filters

SMD Type  
 Microchip Transformer (Balun)

# Impedance Type Filters SMD Type

## NFZ32BW\_11 Series 1210/3225(inch/mm)

### Appearance/Dimensions

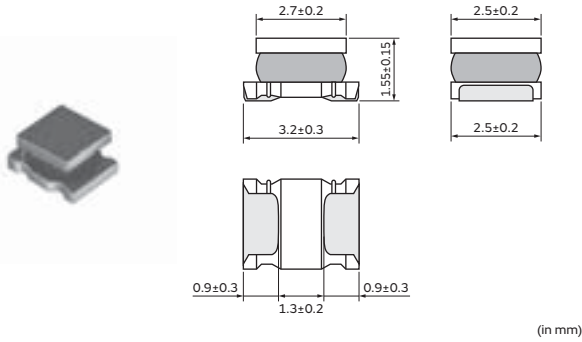

### Packaging

Code	Packaging	Minimum Quantity
K	ø330mm Embossed Tape	7500
L	ø180mm Embossed Tape	2000

### Equivalent Circuit



(Resistance element becomes dominant at high frequencies.)

### Rated Value (□: packaging code)

Part Number		Impedance at 1MHz	Rated Current	DC Resistance
Infotainment	Powertrain/Safety			
NFZ32BW3R3HZ11□	—	3.3Ω±30%	2.9A	0.024Ω±20%
NFZ32BW6R8HZ11□	—	6.8Ω±30%	2.5A	0.036Ω±20%
NFZ32BW8R4HZ11□	—	8.4Ω±30%	2.4A	0.048Ω±20%
NFZ32BW9R8HZ11□	—	9.8Ω±30%	2.1A	0.053Ω±20%
NFZ32BW120HZ11□	—	12Ω±30%	1.85A	0.064Ω±20%
NFZ32BW190HZ11□	—	19Ω±30%	1.8A	0.089Ω±20%
NFZ32BW210HZ11□	—	21Ω±30%	1.55A	0.100Ω±20%
NFZ32BW310HZ11□	—	31Ω±30%	1.2A	0.155Ω±20%
NFZ32BW520HZ11□	—	52Ω±30%	1.1A	0.220Ω±20%
NFZ32BW650HZ11□	—	65Ω±30%	900mA	0.295Ω±20%
NFZ32BW101HZ11□	—	100Ω±30%	900mA	0.475Ω±20%
NFZ32BW151HZ11□	—	150Ω±30%	700mA	0.685Ω±20%

Operating Temp. Range: -40°C to 105°C

Operating Temp. Range self-temp. rise included: -40°C to 125°C

### Z-f Characteristics: NFZ32BW\_11 Series

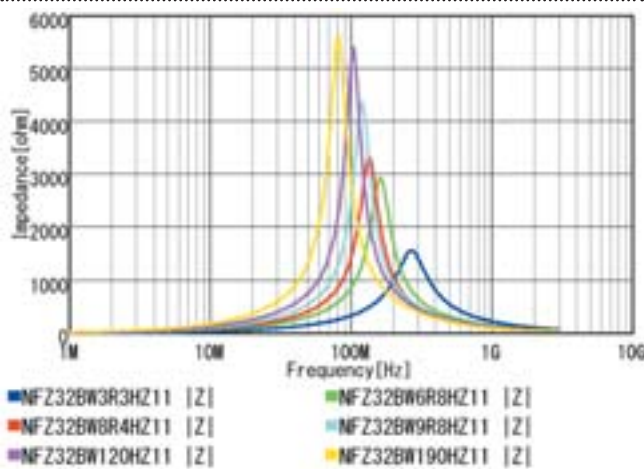

### Z-f Characteristics: NFZ32BW\_11 Series

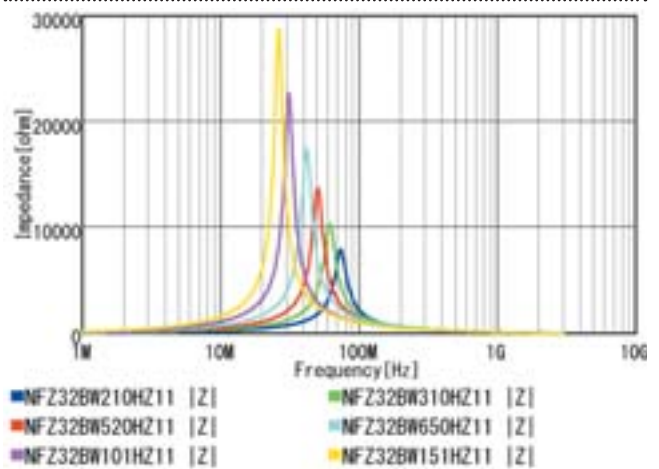

Continued on the following page. ↗

Chip Ferrite Bead SMD Type  
 Chip EMIFIL® SMD Type  
 Chip Common Mode Choke Coil SMD Type  
 Block Type EMIFIL® SMD Type  
 EMI Suppression Filters Lead Type  
 Microchip Transformer (Balun) SMD Type



Continued from the preceding page. ↘

**Z-f characteristics**

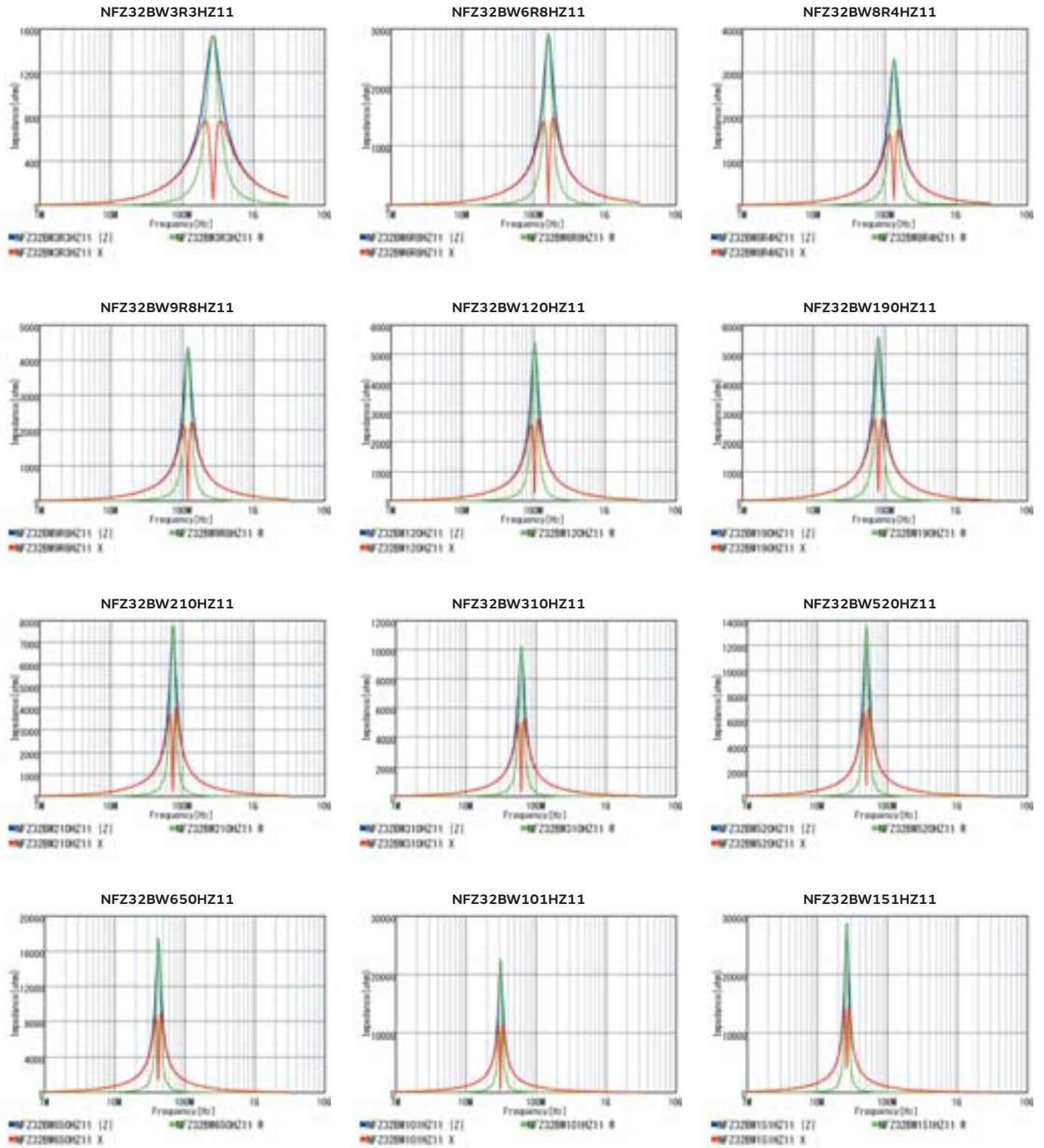

Continued on the following page. ↗

SMD Type  
 Chip Ferrite Bead

SMD Type  
 Chip EMIFIL®

SMD Type  
 Chip Common Mode Choke Coil

SMD Type  
 Block Type EMIFIL®

Lead Type  
 EMI Suppression Filters

SMD Type  
 Microchip Transformer (Balun)

Continued from the preceding page. ↘

## Derating of Rated Current

In operating temperature exceeding +85°C, derating of current is necessary for NFZ32BW\_H□11 series.  
 Please apply the derating curve shown in chart according to the operating temperature.

Derating of Rated Current

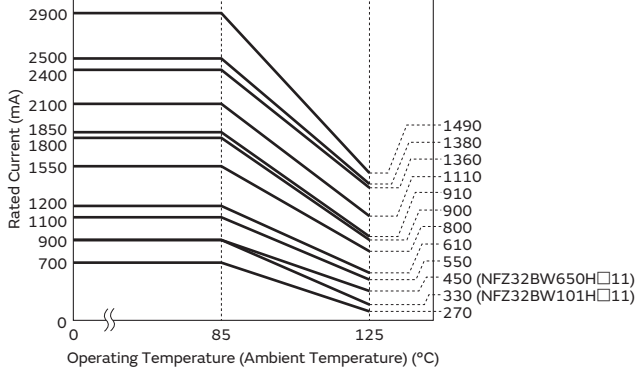

# Impedance Type Filters SMD Type

## NFZ5BBW\_10 Series 2020/5050(inch/mm)

### Appearance/Dimensions

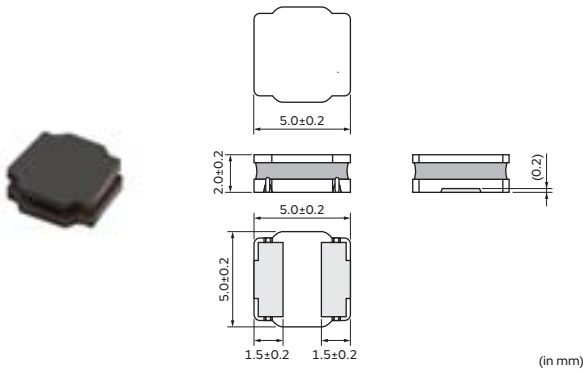

### Packaging

Code	Packaging	Minimum Quantity
K	ø330mm Embossed Tape	3000
L	ø180mm Embossed Tape	500

### Equivalent Circuit

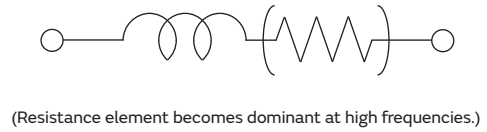

### Rated Value (□: packaging code)

Part Number		Impedance at 1MHz	Rated Current	DC Resistance
Infotainment	Powertrain/Safety			
NFZ5BBW2R9LZ10□	—	2.9Ω±30%	4A	0.012Ω±20%
NFZ5BBW4R5LZ10□	—	4.5Ω±30%	3.4A	0.015Ω±20%
NFZ5BBW6R7LZ10□	—	6.7Ω±30%	3.1A	0.019Ω±20%
NFZ5BBW7R6LZ10□	—	7.6Ω±30%	3.1A	0.019Ω±20%
NFZ5BBW100LZ10□	—	10Ω±30%	3A	0.024Ω±20%
NFZ5BBW140LZ10□	—	14Ω±30%	2.6A	0.030Ω±20%
NFZ5BBW170LZ10□	—	17Ω±30%	2.5A	0.035Ω±20%
NFZ5BBW220LZ10□	—	22Ω±30%	2.3A	0.044Ω±20%
NFZ5BBW310LZ10□	—	31Ω±30%	2A	0.058Ω±20%
NFZ5BBW450LZ10□	—	45Ω±30%	1.65A	0.083Ω±20%
NFZ5BBW520LZ10□	—	52Ω±30%	1.61A	0.100Ω±20%
NFZ5BBW610LZ10□	—	61Ω±30%	1.6A	0.106Ω±20%
NFZ5BBW970LZ10□	—	97Ω±30%	1.2A	0.187Ω±20%
NFZ5BBW141LZ10□	—	140Ω±30%	1.05A	0.259Ω±20%

Operating Temp. Range: -40°C to 105°C

Operating Temp. Range self-temp. rise included: -40°C to 125°C

### Z-f Characteristics: NFZ5BBW\_10 Series

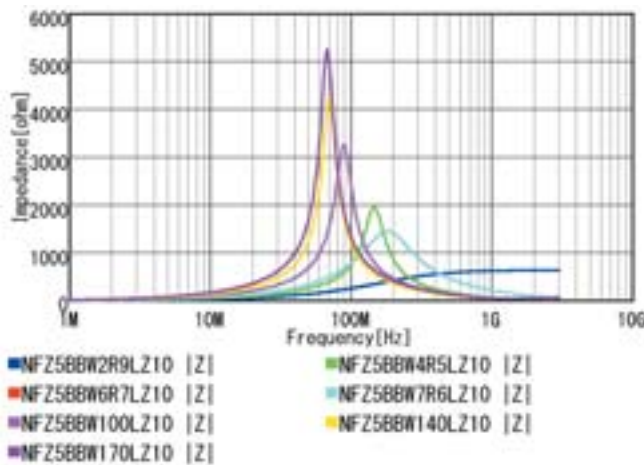

### Z-f Characteristics: NFZ5BBW\_10 Series

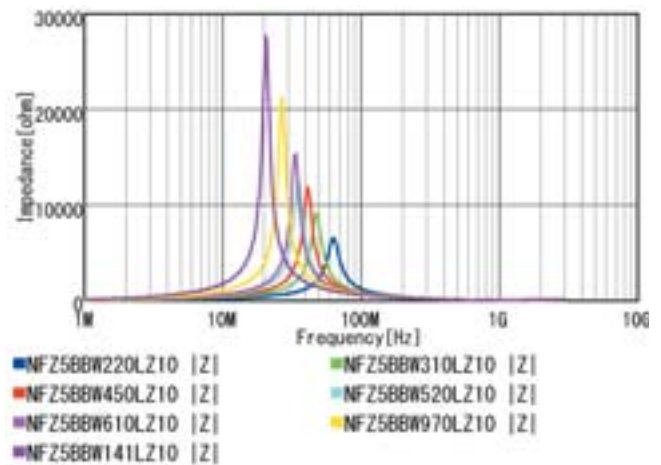

Continued on the following page. ↗

SMD Type  
 Chip Ferrite Bead

SMD Type  
 Chip EMIFIL®

SMD Type  
 Chip Common Mode Choke Coil

SMD Type  
 Block Type EMIFIL®

Lead Type  
 EMI Suppression Filters

SMD Type  
 Microchip Transformer (Balun)

Continued from the preceding page. ↘

**Z-f characteristics**

**NFZ5BBW2R9LZ10**

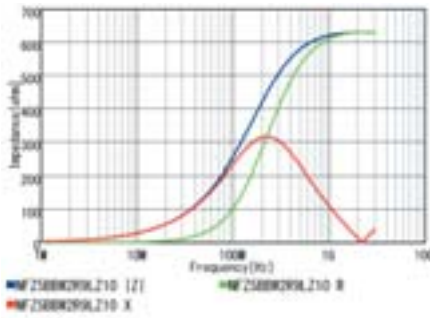

**NFZ5BBW4R5LZ10**

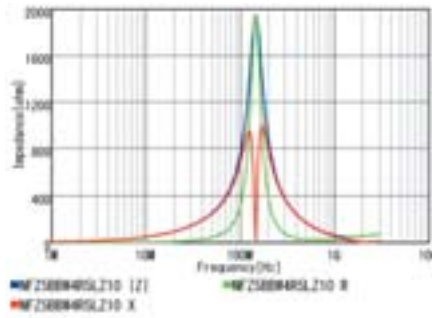

**NFZ5BBW6R7LZ10**

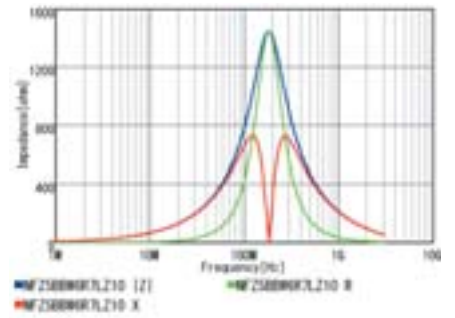

**NFZ5BBW7R6LZ10**

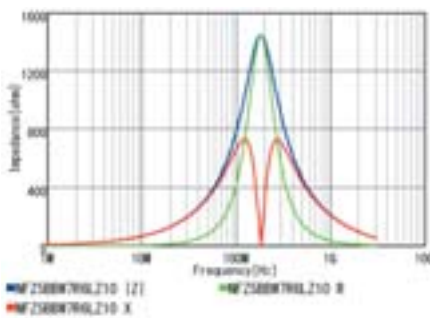

**NFZ5BBW100LZ10**

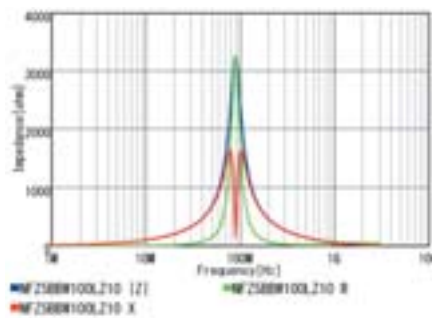

**NFZ5BBW140LZ10**

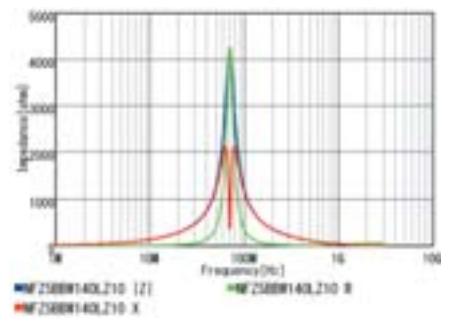

**NFZ5BBW170LZ10**

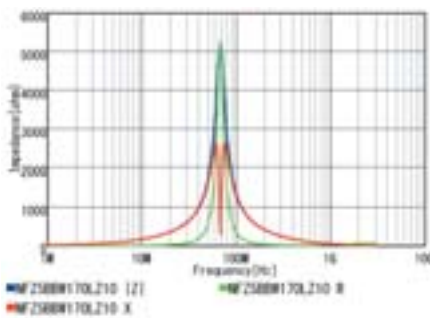

**NFZ5BBW220LZ10**

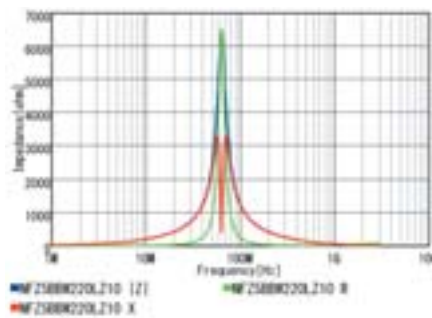

**NFZ5BBW310LZ10**

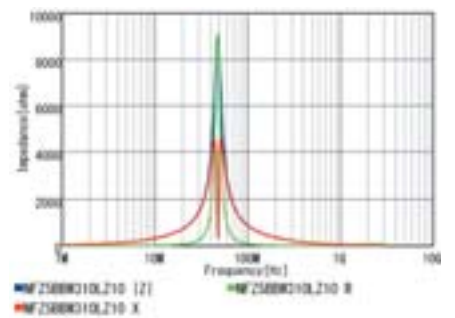

**NFZ5BBW450LZ10**

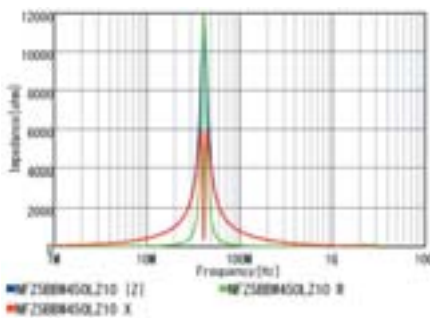

**NFZ5BBW520LZ10**

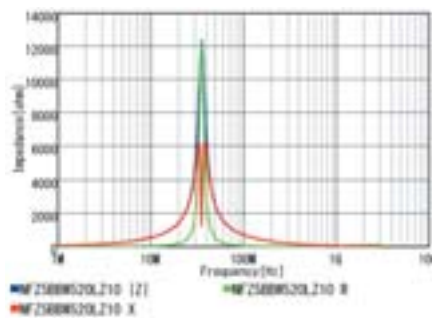

**NFZ5BBW610LZ10**

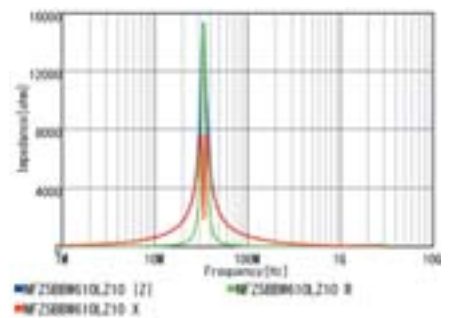

Continued on the following page. ↗

Chip Ferrite Bead  
 SMD Type

Chip EMI FIL®  
 SMD Type

Chip Common Mode Choke Coil  
 SMD Type

Block Type EMI FIL®  
 SMD Type

EMI Suppression Filters  
 Lead Type

Microchip Transformer (Balun)  
 SMD Type

Continued from the preceding page. ↘

### Z-f characteristics

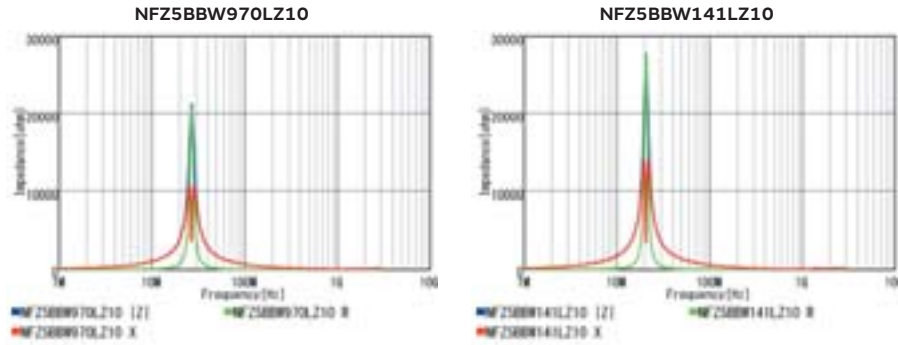

### Derating of Rated Current

In operating temperature exceeding +85°C, derating of current is necessary for NFZ5BBW\_L□10 series. Please apply the derating curve shown in chart according to the operating temperature.

Derating of Rated Current

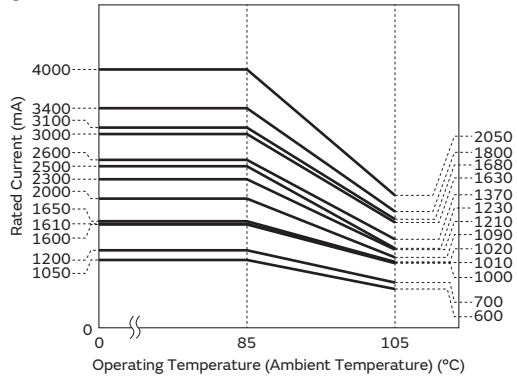

SMD Type  
 Chip Ferrite Bead

SMD Type  
 Chip EMIFIL®

SMD Type  
 Chip Common Mode Choke Coil

SMD Type  
 Block Type EMIFIL®

Lead Type  
 EMI Suppression Filters

SMD Type  
 Microchip Transformer (Balun)

## Chip EMIFIL® (NF□ Series) ⚠Caution/Notice

### ⚠Caution

#### Rating

##### 1. About the Rated Current

Do not use products beyond the rated current and rated voltage as this may create excessive heat and deteriorate the insulation resistance.

##### 2. About the Excessive Surge Current (NFZ Series)

Excessive surge current (pulse current or rush current)

than specified rated current applied to the product may cause a critical failure, such as an open circuit, burnout caused by excessive temperature rise. Please contact us in advance in case of applying the surge current.

#### Soldering and Mounting

1. Be sure to provide an appropriate fail-safe function on your product to prevent a second damage that may be caused by the abnormal function or the failure our product.

### Notice

#### Storage and Operating Condition

##### <Operating Environment>

Do not use products in the corrodible atmosphere such as acidic gases, alkaline gases, chlorine, sulfur gases, organic gases. (the sea breeze, Cl<sub>2</sub>, H<sub>2</sub>S, NH<sub>3</sub>, SO<sub>2</sub>, NO<sub>2</sub>, etc)

Do not use products in the environment close to the organic solvent.

##### <Storage and Handling Requirements>

##### 1. Storage Period

The NF series should be used within 12 months.  
Products to be used after this period should be checked for solderability or bondability with glue.

##### 2. Storage Conditions

- (1) Storage temperature: -10 to +40°C  
Relative humidity: 15 to 85%  
Avoid sudden changes in temperature and humidity.
- (2) Do not store products in a chemical atmosphere such as chlorine gas, acid or sulfide gas.

#### Notice (Soldering and Mounting)

##### 1. Cleaning

Failure and degradation of a product are caused by the cleaning method. When you clean in conditions that are not in mounting information, please contact Murata engineering.

##### 2. Soldering

Reliability decreases with improper soldering methods. Please solder by the standard soldering conditions shown in mounting information.

##### 3. Other

Noise suppression levels resulting from Murata's EMI suppression filters EMIFIL® may vary, depending on the circuits and ICs used, type of noise, mounting pattern, mounting location, and other operating conditions. Be sure to check and confirm in advance the noise suppression effect of each filter, in actual circuits, etc. before applying the filter in a commercial-purpose equipment design.

Continued on the following page. ↗

## Chip EMIFIL® (NF□ Series) ⚠Caution/Notice

Continued from the preceding page. ↘

### Handling

#### 1. Resin Coating (Except for NFZ Series)

Using resin for coating/molding products may affect the products performance.

So please pay careful attention in selecting resin.

Prior to use, please make the reliability evaluation with the product mounted in your application set.

#### Resin Coating (NFZ\_W Series)

To prevent breaking the wire, avoid touching with sharp material, such as tweezers or other material such as bristles of cleaning brush, to the wire wound portion of this product. To prevent breaking the core, avoid applying excessive mechanical shock to products mounted on the board. An open circuit issue may occur by mechanical stress caused by the resin, amount/cured shape of resin, or operating condition etc. Some resins containing impurities or chloride may possibly.

#### 2. Handling of a Substrate

After mounting products on a substrate, do not apply any stress to the product caused by bending or twisting to the substrate when cropping the substrate, inserting and removing a connector from the substrate or tightening screw to the substrate.

Excessive mechanical stress may cause cracking in the Product.

Bending

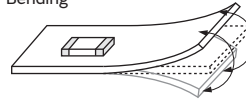

Twisting

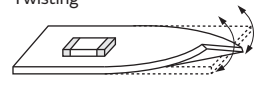

# Chip EMIFIL® (NF□ Series) Soldering and Mounting

## 1. Standard Land Pattern Dimensions

NF□ series suppress noise by conducting the high-frequency noise element to ground. Therefore, to obtain maximum performance from these filters, the ground pattern should be made as large as possible during the PCB design stage. As shown below, one side of the PCB is used for chip mounting, and the other is used for grounding.

Small diameter feedthrough holes are then used to connect the grounds on each side of the PCB. This reduces the high-frequency impedance of the grounding and maximizes the filter's performance.

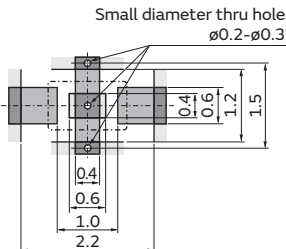
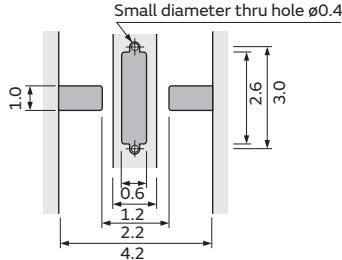
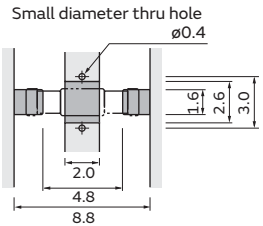
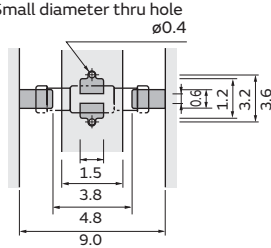
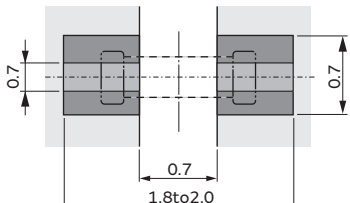

Series	Standard Land Dimensions	
<b>NFL18ZT</b>	<p>● Reflow Soldering NFL18ZT</p> 	
<b>NFE31ZT</b>	<p>● Reflow Soldering NFE31ZT</p> 	
<b>NFE61HT</b>	<p>● Reflow Soldering</p> 	<p>● Flow Soldering (Except for NFE61HT332)</p> 
<b>NFZ18SM</b>	<p>● Reflow Soldering</p> 	

Continued on the following page. ↗

Chip Ferrite Bead  
SMD Type

Chip EMIFIL®  
SMD Type

Chip Common Mode Choke Coil  
SMD Type

Block Type EMIFIL®  
SMD Type

EMI Suppression Filters  
Lead Type

Microchip Transformer (Balun)  
SMD Type



# Chip EMIFIL® (NF□ Series) Soldering and Mounting

Continued from the preceding page. ↘

Land Pattern + Solder Resist  
 Land Pattern  
 Solder Resist (in mm)

Series	Standard Land Dimensions	
NFZ32BW	<b>● Reflow Soldering</b> 	<b>● Flow Soldering</b> 
	<b>● Reflow Soldering</b> 	<b>● Flow Soldering</b> 

**(1) PCB Warping**

PCB should be designed so that products are not subjected to the mechanical stress caused by warping the board.

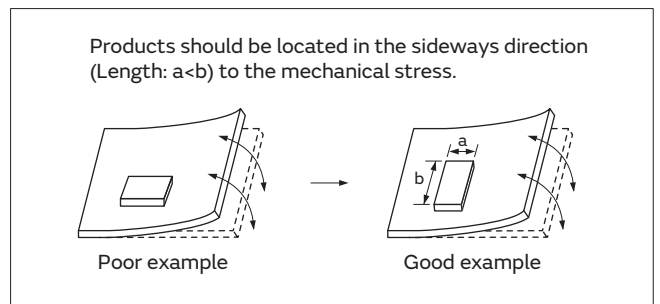

**(2) Amount of Solder Paste**

Excessive solder causes electrode corrosion, while insufficient solder causes low electrode bonding strength. Adjust the amount of solder paste as shown on the right so that solder is applied.

- Guideline of solder paste thickness
  - NFZ32BW / 5BBW: 100 to 150 $\mu$ m
  - NFZ18SM: 100 to 200 $\mu$ m

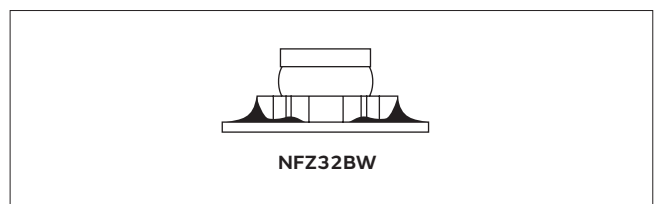

Continued on the following page. ↗

SMD Type  
Chip Ferrite Bead

SMD Type  
Chip EMIFIL®

SMD Type  
Chip Common Mode Choke Coil

SMD Type  
Block Type EMIFIL®

Lead Type  
EMI Suppression Filters

SMD Type  
Microchip Transformer (Balun)

## Chip EMIFIL® (NF□ Series) Soldering and Mounting

Continued from the preceding page. ↘

### 2. Solder Paste Printing and Adhesive Application

When reflow soldering the chip EMI suppression filter, the printing must be conducted in accordance with the following cream solder printing conditions.

If too much solder is applied, the chip will be prone to damage by mechanical and thermal stress from the PCB and may crack.

Standard land dimensions should be used for resist and copper foil patterns.

When flow soldering the EMI suppression filter, apply the adhesive in accordance with the following conditions. If too much adhesive is applied, then it may overflow into the land or termination areas and yield poor solderability. In contrast, if insufficient adhesive is applied, or if the adhesive is not sufficiently hardened, then the chip may become detached during flow soldering process.

Series	Solder Paste Printing	Adhesive Application
NFL18ZT	<p>●Guideline of solder paste thickness: 100-150μm</p>	(in mm)
NFE31ZT	<p>●Guideline of solder paste thickness: 150-200μm</p>	
NFE61HT	<p>●Guideline of solder paste thickness: 150-200μm</p>	
NFZ5BBW		<p>Apply 1.0mg of bonding agent at each chip.</p> <p>* Except for NFE61HT332</p> <p>Amount of adhesive applied is a standard 1/2 to 2/3 of the bottom flange thickness.</p> <p>Adhesive application is recommended the 3-point application. (prevent the drop of products)</p>

Continued on the following page. ↗

## Chip EMIFIL® (NF□ Series) Soldering and Mounting

Continued from the preceding page. ↘

### 3. Standard Soldering Conditions

#### (1) Soldering Methods

Use flow and reflow soldering methods only.  
 Use standard soldering conditions when soldering chip EMI suppression filters.  
 In cases where several different parts are soldered, each having different soldering conditions, use those conditions requiring the least heat and minimum time.

#### Flux:

- Use Rosin-based flux.  
 In case of using RA type solder, products should be cleaned completely with no residual flux.
- Do not use strong acidic flux (with chlorine content exceeding 0.20wt%)
- Do not use water-soluble flux.

Solder: Use Sn-3.0Ag-0.5Cu solder. Use of Sn-Zn based solder will deteriorate performance of products.  
 If using NFM series with Sn-Zn based solder, please contact Murata in advance.

For additional mounting methods, please contact Murata.

#### (2) Soldering Profile

##### ● Flow Soldering Profile (Sn-3.0Ag-0.5Cu Solder)

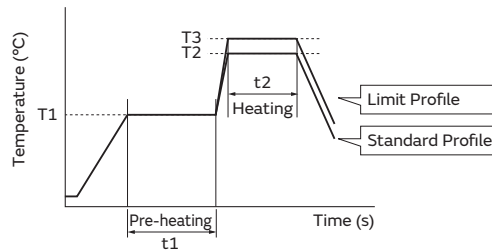

Series	Pre-heating		Standard Profile			Limit Profile		
	Temp. (T1)	Time. (t1)	Temp. (T2)	Time. (t2)	Cycle of Flow	Temp. (T3)	Time. (t2)	Cycle of Flow
NFE61HT (Except for NFE61HT332)	150°C	60s min.	250°C	4 to 6s	2 times max.	265±3°C	5s max.	2 times max.
NFZ5BBW	150°C	60s min.	250°C	4 to 6s	2 times max.	265±3°C	5s max.	1 time

##### ● Reflow Soldering Profile (Sn-3.0Ag-0.5Cu Solder)

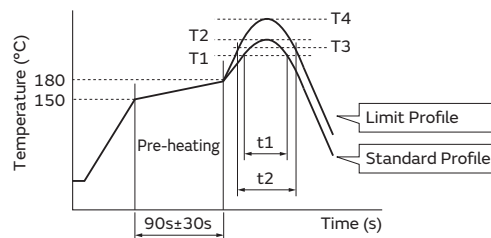

Series	Standard Profile				Limit Profile			
	Temp. (T1)	Time. (t1)	Peak Temperature (T2)	Cycle of Reflow	Temp. (T3)	Time. (t2)	Peak Temperature (T4)	Cycle of Reflow
NFE31ZT NFE61HT NFL18ZT NFZ18SM NFZ32BW NFZ5BBW	220°C min.	30 to 60s	245±3°C	2 times max.	230°C min.	60s max.	260°C/10s	2 times max.

Continued on the following page. ↗

## Chip EMIFIL® (NF□ Series) Soldering and Mounting

Continued from the preceding page. ↘

### (3) Reworking with Solder Iron

The following conditions must be strictly followed when using a soldering iron.

Pre-heating: 150°C 60s min.

Soldering iron power output / Tip diameter:

30W max. / ø3mm max.\*<sup>1</sup>

\*<sup>1</sup> NFZ18SM/32/5BBW: 80W max. / ø3mm max.

Temperature of soldering iron tip / Soldering time /

Times:

350°C max. / 3-4s / 2 times\*<sup>2</sup>

\*<sup>2</sup> NFE31ZT15Z21E9□: 280°C max. / 10s max.

NFZ5BBW: 380°C max. /3-4s

Do not allow the tip of the soldering iron to directly contact the chip.

For additional methods of reworking with a soldering iron, please contact Murata engineering.

## 4. Cleaning

Following conditions should be observed when cleaning chip EMI filter.

(1) Cleaning Temperature: 60°C max. (40°C max. for alcohol type cleaner)

(2) Ultrasonic

Output: 20W/liter max.

Duration: 5 minutes max.

Frequency: 28 to 40kHz

Care should be taken not to cause resonance of the PCB and mounted products.

(3) Cleaning Agent

The following list of cleaning agents have been tested on the individual components. Evaluation of final assembly should be completed prior to production.

(a) Alcohol cleaning agent

Isopropyl alcohol (IPA)

(b) Aqueous cleaning agent

Pine Alpha ST-100S

(4) Ensure that flux residue is completely removed.

Component should be thoroughly dried after aqueous agent has been removed with deionized water.

## Chip EMIFIL® (NF□ Series) Packaging

### Minimum Quantity and Dimensions of 8mm Width Paper / Embossed Tape

(Common to Paper Tape / Embossed Tape)

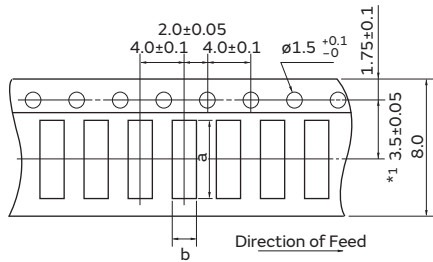

<Embossed>

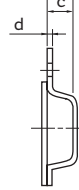

c: Depth of Cavity  
(Embossed Tape)

<Paper>

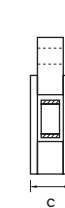

c: Total Thickness of Tape  
(Paper Tape)

Dimension of the cavity of embossed tape is measured at the bottom side.

Part Number	Dimensions				Minimum Qty. (pcs.)				
					ø180mm Reel		ø330mm Reel		Bulk
	a	b	c	d	Paper Tape	Embossed Tape	Paper Tape	Embossed Tape	
NFL18ZT	1.85	1.05	0.9 max.	-	4000	-	-	-	1000
NFE31ZT	3.6	1.8	1.85	0.2	-	2000	-	8000	500
NFZ18SM	1.85	1.05	1.1	-	4000	-	-	-	1000
NFZ32BW	3.6	2.9	1.7	0.2	-	2000	-	7500	-

(in mm)

### Minimum Quantity and Dimensions of 12mm Width Embossed Tape

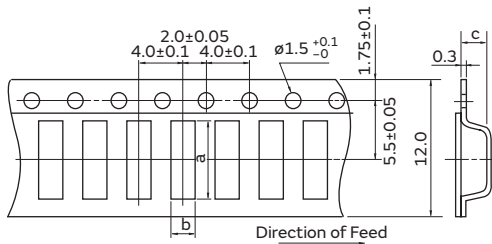

c: Depth of Cavity

Part Number	Dimensions			Minimum Qty. (pcs.)		
	a	b	c	ø180mm Reel	ø330mm Reel	Bulk
NFE61HT	7.2	1.9	1.75	2500	8000	500

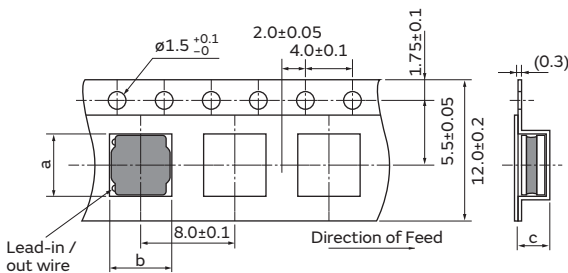

Dimension of the cavity is measured at the bottom side.

Part Number	Dimensions			Minimum Qty. (pcs.)		
	a	b	c	ø180mm Reel	ø330mm Reel	Bulk
NFZ5BBW	5.3	5.3	2.4	500	3000	-

(in mm)

"Minimum Quantity" means the number of units of each delivery or order. The quantity should be an integral multiple of the "Minimum Quantity."

● Part Numbering

Chip Common Mode Choke Coil for Automotive

(Part Number) 

DL	W	43	S	H	101	X	K	2	L
①	②	③	④	⑤	⑥	⑦	⑧	⑨	⑩

① Product ID

Product ID	
DL	Chip Common Mode Choke Coils

② Structure

Code	Structure
W	Wire Wound Type

③ Dimensions (LxW)

Code	Dimensions (LxW)	Size Code (inch)
21	2.0x1.2mm	0805
31	3.2x1.6mm	1206
32	3.2x2.5mm	1210
43	4.5x3.2mm	1812
44	4.0x4.0mm	1515
5A	5.0x3.6mm	2014
5B	5.0x5.0mm	2020

④ Features (1)

Code	Type
S	Magnetically Shielded One Circuit Type
T	One Circuit Low Profile Type
M	Magnetically Shielded One Circuit Type (Transfer mode conversion characteristics improved)

⑤ Category

Code	Category	
Z	For Automotive	Infotainment
H		Powertrain, Safety

⑩ Packaging

Code	Packaging	Series
K	Embossed Taping (ø330mm Reel)	<b>DLW43/DLW44S/DLW5AT/DLW5BS/DLW5BT</b>
L	Embossed Taping (ø180mm Reel)	All Series
B	Bulk	All Series

⑥ Impedance

Typical impedance at 100MHz is expressed by three figures. The unit is in ohm ( $\Omega$ ). The first and second figures are significant digits, and the third figure expresses the number of zeros that follow the two figures.

⑥ Inductance (DLW43SH)

Expressed by three figures. The unit is micro-henry ( $\mu$ H). The first and second figures are significant digits, and the third figure expresses the number of zeros which follow the two figures.

⑦ Circuit

Code	Circuit
S	Expressed by a letter.
M	
H	
T	
X	

⑧ Features (2)

Code	Features
K	Expressed by a letter.
P	
Q	

⑨ Number of Signal Lines

Code	Number of Signal Lines
2	Two Lines

### Chip Common Mode Choke Coil for Automotive

(Part Number) 

DL	M	11	S	N	900	H	Z	2	L
1	2	3	4	5	6	7	8	9	10

**1** Product ID

Product ID	
DL	Chip Common Mode Choke Coils

**2** Structure

Code	Structure
M	Multilayer Type

**3** Dimensions (LxW)

Code	Dimensions (LxW)	Size Code (inch)
OQ	0.65x0.5mm	025020
ON	0.85x0.65mm	03025
11	1.25x1.0mm	0504

**4** Features (1)

Code	Type
S	Magnetically Shielded One Circuit Type

**5** Category

Code	Category
N	For General

**6** Impedance

Typical impedance at 100MHz is expressed by three figures. The unit is in ohm ( $\Omega$ ). The first and second figures are significant digits, and the third figure expresses the number of zeros that follow the two figures.

**7** Circuit

Code	Circuit
H	Expressed by a letter.

**8** Features (2)

Code	Features
Z	Infotainment
H	For Automotive Powertrain, Safety

**9** Number of Signal Lines

Code	Number of Signal Lines
2	Two Lines

**10** Packaging

Code	Packaging
L	Embossed Taping ( $\phi$ 180mm Reel)
B	Bulk

SMD Type  
Chip Ferrite Bead

SMD Type  
Chip EMIFIL®

SMD Type  
Chip Common Mode Choke Coil

SMD Type  
Block Type EMIFIL®

Lead Type  
EMI Suppression Filters

SMD Type  
Microchip Transformer (Balun)

### Common Mode Choke Coil for Automotive

(Part Number) 

PL	T	10H	H	102	6R0	P	N	B
①	②	③	④	⑤	⑥	⑦	⑧	⑨

#### ① Product ID

Product ID	
<b>PL</b>	Common Mode Choke Coils

#### ② Type

Code	Type
<b>T</b>	DC Type

#### ③ Applications

Code	Applications
<b>10H</b>	For DC Line High-frequency Type
<b>5BP</b>	5.0x5.0mm Size, for DC Lines

#### ④ Features (1)

Code	Features	
<b>H</b>	For Automotive	Powertrain, Safety

#### ⑤ Impedance

Expressed by three figures. The unit is ohm ( $\Omega$ ). The first and second figures are significant digits, and the third figure expresses the number of zeros that follow the two figures.

#### ⑥ Rated Current

Expressed by three figures. The unit is ampere (A). The first and second figures are significant digits, and the third figure expresses the number of zeros that follow the two figures. A decimal point is expressed by the capital letter "R." In this case, all figures are significant digits.

#### ⑦ Features (2)

Code	Features
<b>P</b>	Expressed by a letter.
<b>S</b>	

#### ⑧ Lead Dimensions

Code	Lead Dimensions
<b>N</b>	No Lead Terminal (SMD)

#### ⑨ Packaging

Code	Packaging	Series
<b>B</b>	Bulk	<b>PLT10H, PLT5BP</b>
<b>L</b>	Embossed Taping ( $\phi$ 178mm/ $\phi$ 180mm Reel)	<b>PLT10H, PLT5BP</b>
<b>K</b>	Embossed Taping ( $\phi$ 330mm Reel)	<b>PLT10H</b>



# Chip Common Mode Choke Coil SMD Type

## DLM11S Series 0504/1210(inch/mm)

### Appearance/Dimensions

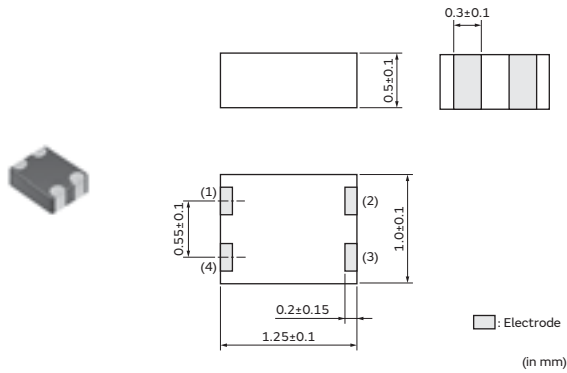

### Packaging

Code	Packaging	Minimum Quantity
L	ø180mm Embossed Tape	4000
B	Bulk(Bag)	500

### Equivalent Circuit

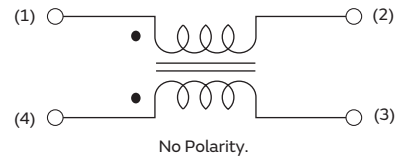

### Rated Value (□: packaging code)

Part Number		Common Mode Impedance at 100MHz	Rated Current	Rated Voltage	Insulation Resistance (Min.)	Withstanding Voltage	DC Resistance
Infotainment	Powertrain/Safety						
DLM11SN450HZ2□	—	45Ω±25%	100mA	5Vdc	100MΩ	12.5Vdc	0.7Ω±25%
DLM11SN900HZ2□	—	90Ω±25%	100mA	5Vdc	100MΩ	12.5Vdc	1.1Ω±25%

Operating Temp. Range: -55°C to 125°C

### Z-f characteristics: DLM11SN\_HZ2 series

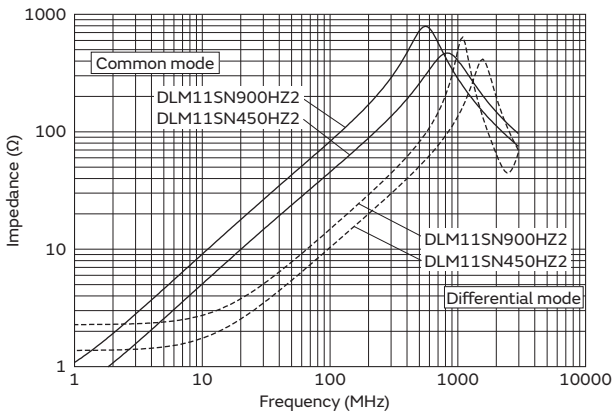

### Differential mode Z-f characteristics: DLM11SN\_HZ2 series

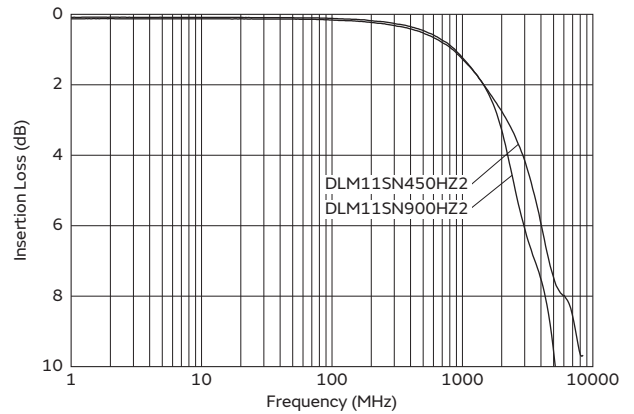

SMD Type  
 Chip Ferrite Bead

SMD Type  
 Chip EMIFIL®

SMD Type  
 Chip Common Mode Choke Coil

SMD Type  
 Block Type EMIFIL®

Lead Type  
 EMI Suppression Filters

SMD Type  
 Microchip Transformer (Balun)

# Chip Common Mode Choke Coil SMD Type

## DLW21S Series 0805/2012(inch/mm)

### Appearance/Dimensions

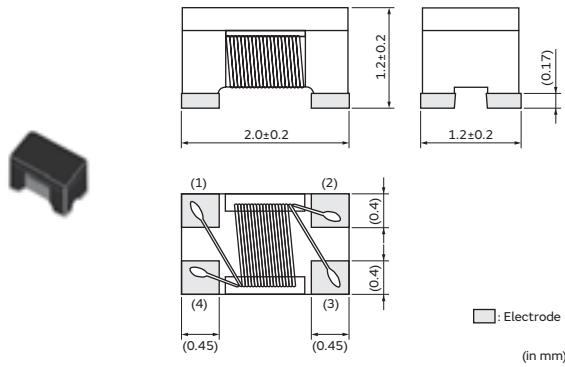

### Packaging

Code	Packaging	Minimum Quantity
L	ø180mm Embossed Tape	2000
B	Bulk(Bag)	500

### Equivalent Circuit

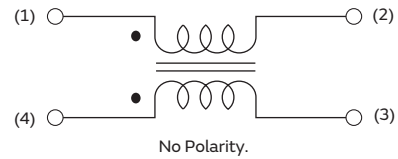

### Rated Value (□: packaging code)

Part Number		Common Mode Impedance at 100MHz	Rated Current	Rated Voltage	Insulation Resistance (Min.)	Withstanding Voltage	DC Resistance
Infotainment	Powertrain/Safety						
DLW21SZ670HQ2□	—	67Ω±25%	320mA	20Vdc	10MΩ	50Vdc	0.31Ω max.
DLW21SZ900HQ2□	—	90Ω±25%	280mA	20Vdc	10MΩ	50Vdc	0.41Ω max.
DLW21SZ121HQ2□	—	120Ω±25%	280mA	20Vdc	10MΩ	50Vdc	0.41Ω max.
DLW21SZ181XQ2□	—	180Ω±25%	240mA	20Vdc	10MΩ	50Vdc	0.39Ω max.
DLW21SZ261XQ2□	—	260Ω±25%	220mA	20Vdc	10MΩ	50Vdc	0.59Ω max.
DLW21SZ491XQ2□	—	490Ω±25%	200mA	20Vdc	10MΩ	50Vdc	0.77Ω max.

Operating Temp. Range: -40°C to 105°C

### Z-f characteristics: DLW21SZ\_HQ2 series

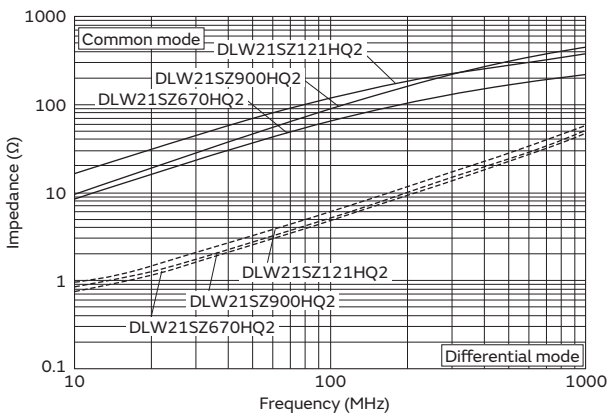

### Differential mode transmission loss: DLW21SZ\_HQ2 series

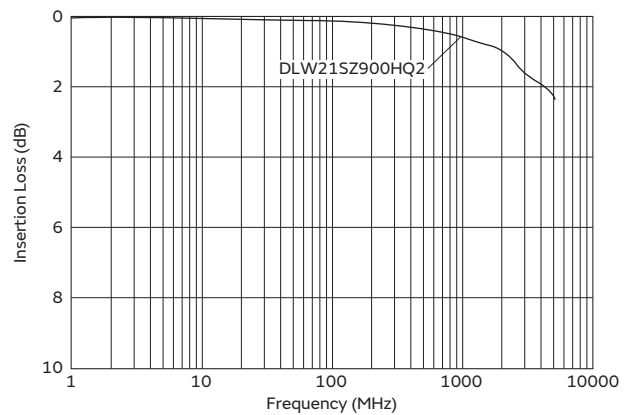

Continued on the following page. ↗

Chip Ferrite Bead SMD Type

Chip EMIFIL® SMD Type

Chip Common Mode Choke Coil SMD Type

Block Type EMIFIL® SMD Type

EMI Suppression Filters Lead Type

Microchip Transformer (Balun) SMD Type

Continued from the preceding page. ↘

**Z-f characteristics: DLW21SZ\_XQ2 series**

**Differential mode transmission loss: DLW21SZ\_XQ2 series**

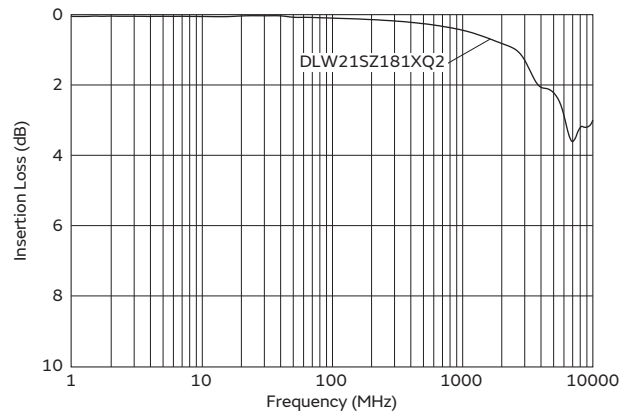
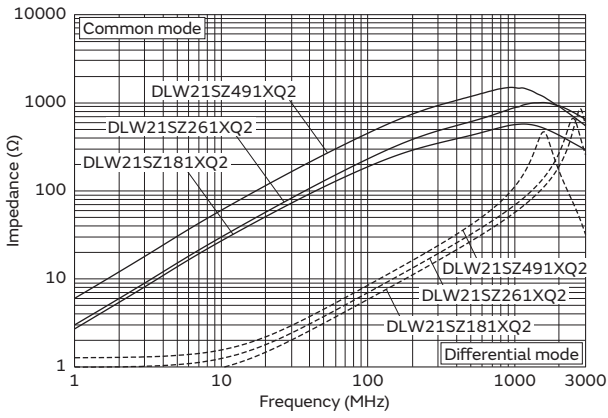

SMD Type  
 Chip Ferrite Bead

SMD Type  
 Chip EMIFIL®

SMD Type  
 Chip Common Mode Choke Coil

SMD Type  
 Block Type EMIFIL®

Lead Type  
 EMI Suppression Filters

SMD Type  
 Microchip Transformer (Balun)

# Chip Common Mode Choke Coil SMD Type

## DLW31S Series 1206/3216(inch/mm)

### Appearance/Dimensions

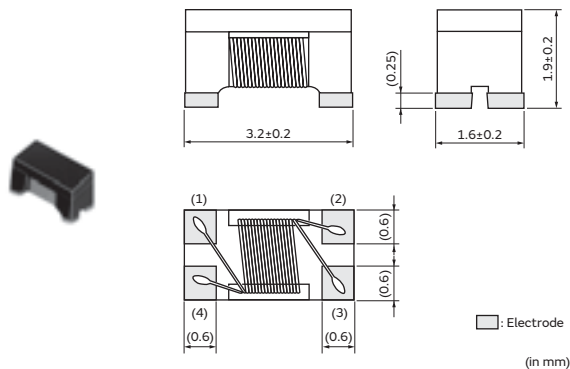

### Packaging

Code	Packaging	Minimum Quantity
L	ø180mm Embossed Tape	2000
B	Bulk(Bag)	500

### Equivalent Circuit

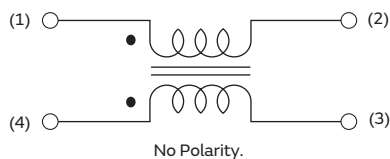

### Rated Value (□: packaging code)

Part Number		Common Mode Impedance at 100MHz	Rated Current	Rated Voltage	Insulation Resistance (Min.)	Withstanding Voltage	DC Resistance
Infotainment	Powertrain/Safety						
—	DLW31SH222SQ2□	2200Ω±25%	80mA	32Vdc	10MΩ	80Vdc	1.6Ω±20%

Operating Temp. Range: -40°C to 125°C

### Z-f characteristics: DLW31SH\_SQ2 series

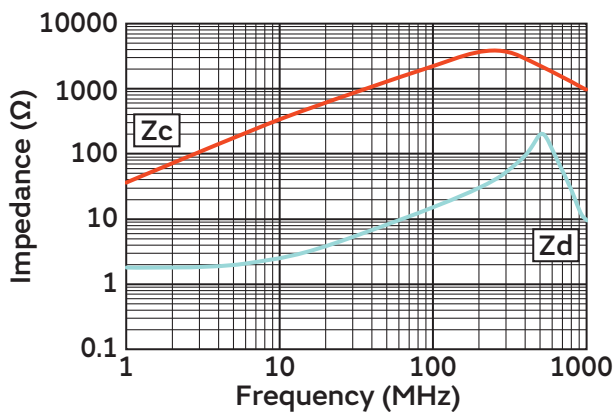

# Chip Common Mode Choke Coil SMD Type

## DLW32S Series 1210/3225(inch/mm)

### Appearance/Dimensions

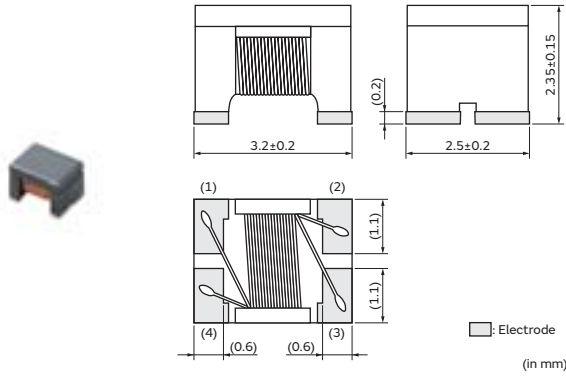

### Packaging

Code	Packaging	Minimum Quantity
L	ø180mm Embossed Tape	1500
B	Bulk(Bag)	500

### Equivalent Circuit

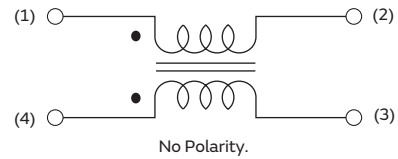

### Rated Value (□: packaging code)

Part Number		Common Mode Inductance	Rated Current	Rated Voltage	Insulation Resistance (Min.)	Withstanding Voltage	DC Resistance
Infotainment	Powertrain/Safety						
—	DLW32SH110XK2□	11μH-30%/+50% (at 0.1MHz)	300mA	80Vdc	10MΩ	200Vdc	0.4Ω max.
—	DLW32SH220XK2□	22μH-30%/+50% (at 0.1MHz)	250mA	80Vdc	10MΩ	200Vdc	0.5Ω max.
—	DLW32SH510XK2□	51μH-30%/+50% (at 0.1MHz)	200mA	80Vdc	10MΩ	200Vdc	0.7Ω max.
—	DLW32SH101XK2□	100μH-30%/+50% (at 0.1MHz)	150mA	80Vdc	10MΩ	200Vdc	1.5Ω max.

Operating Temp. Range: -40°C to 125°C

### Z-f characteristics: DLW32SH\_XK2 series

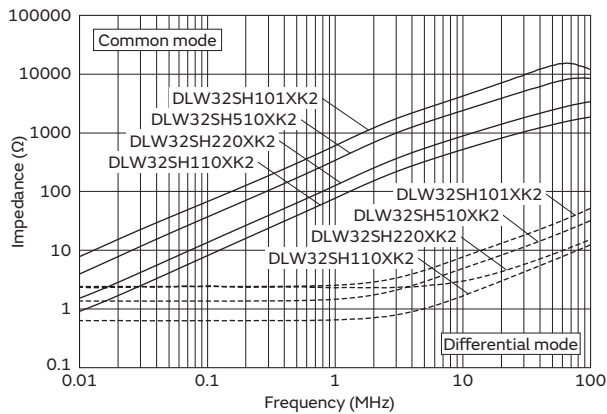

SMD Type  
 Chip Ferrite Bead

SMD Type  
 Chip EMIFIL®

SMD Type  
 Chip Common Mode Choke Coil

SMD Type  
 Block Type EMIFIL®

Lead Type  
 EMI Suppression Filters

SMD Type  
 Microchip Transformer (Balun)

# Chip Common Mode Choke Coil SMD Type

## DLW43M Series 1812/4532(inch/mm)

### Appearance/Dimensions

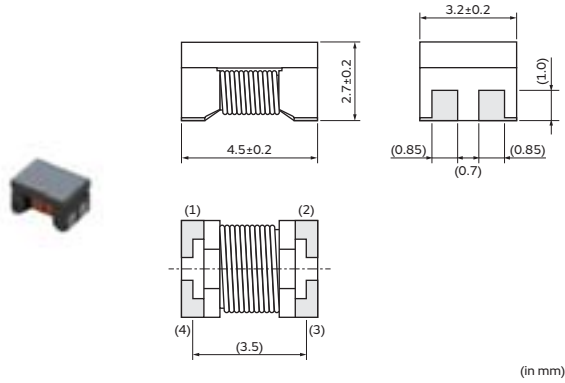

### Packaging

Code	Packaging	Minimum Quantity
K	ø330mm Embossed Tape	2500
L	ø180mm Embossed Tape	500
B	Bulk(Bag)	100

### Equivalent Circuit

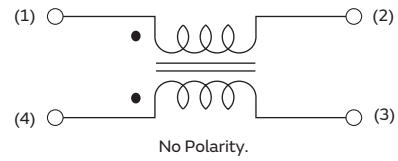

### Rated Value (□: packaging code)

Part Number		Common Mode Inductance	Rated Current	Rated Voltage	Insulation Resistance (Min.)	Withstanding Voltage	DC Resistance
Infotainment	Powertrain/Safety						
—	DLW43MH201XK2□	200μH-25%/+50% (at 0.1MHz)	110mA	20Vdc	10MΩ	50Vdc	4.5Ω max.

Operating Temp. Range: -40°C to 105°C

### Z-f characteristics: DLW43MH\_XK2 series

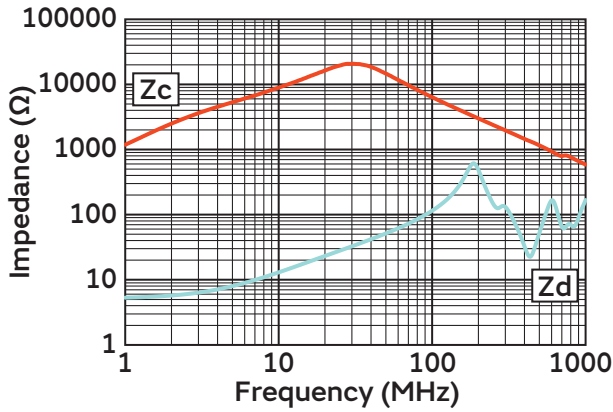

Chip Ferrite Bead  
SMD Type

Chip EMIFIL®  
SMD Type

Chip Common Mode Choke Coil  
SMD Type

Block Type EMIFIL®  
SMD Type

EMI Suppression Filters  
Lead Type

Microchip Transformer (Balun)  
SMD Type

# Chip Common Mode Choke Coil SMD Type

## DLW43S Series 1812/4532(inch/mm)

### Appearance/Dimensions

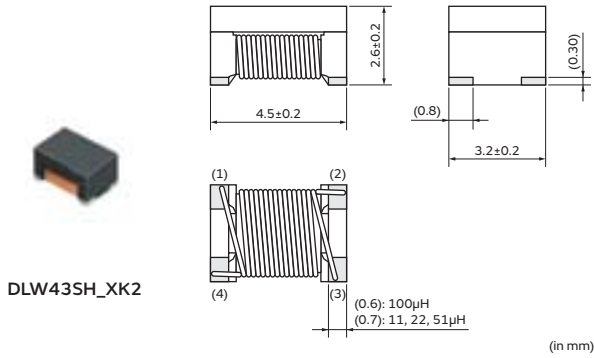

### Packaging

Code	Packaging	Minimum Quantity
K	ø330mm Embossed Tape	2500
L	ø180mm Embossed Tape	500
B	Bulk(Bag)	100

### Equivalent Circuit

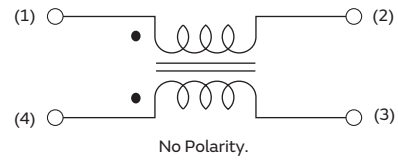

### Appearance/Dimensions

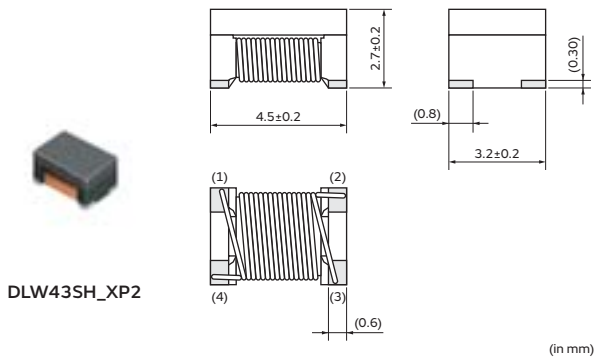

### Rated Value (□: packaging code)

Part Number		Common Mode Inductance	Rated Current	Rated Voltage	Insulation Resistance (Min.)	Withstanding Voltage	DC Resistance
Infotainment	Powertrain/Safety						
—	DLW43SH110XK2□	11μH-30%/+50% (at 0.1MHz)	360mA	50Vdc	10MΩ	125Vdc	0.5Ω max.
—	DLW43SH220XK2□	22μH-30%/+50% (at 0.1MHz)	310mA	50Vdc	10MΩ	125Vdc	0.6Ω max.
—	DLW43SH510XK2□	51μH-30%/+50% (at 1MHz)	230mA	50Vdc	10MΩ	125Vdc	1.0Ω max.
—	DLW43SH101XK2□	100μH-30%/+50% (at 1MHz)	200mA	50Vdc	10MΩ	125Vdc	2.0Ω max.
—	DLW43SH101XP2□	100μH-30%/+80% (at 0.1MHz)	170mA	50Vdc	10MΩ	125Vdc	2.0Ω max.

Operating Temp. Range: -40°C to 125°C

Continued on the following page. ↗

Continued from the preceding page. ↘

**Z-f characteristics: DLW43SH\_XK2 series**

**Z-f characteristics: DLW43SH\_XP2 series**

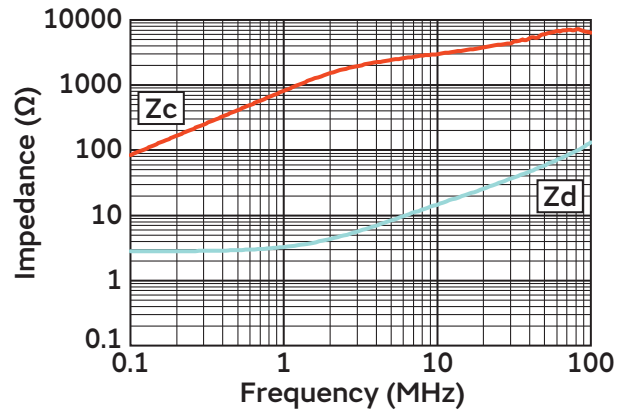
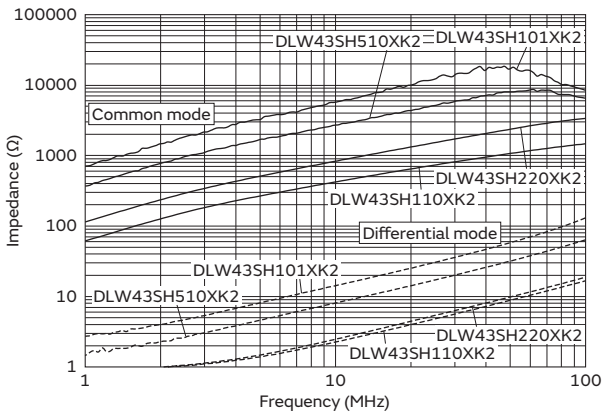

Chip Ferrite Bead  
 SMD Type

Chip EMIFIL®  
 SMD Type

Chip Common Mode Choke Coil  
 SMD Type

Block Type EMIFIL®  
 SMD Type

EMI Suppression Filters  
 Lead Type

Microchip Transformer (Balun)  
 SMD Type



# Chip Common Mode Choke Coil SMD Type

## DLW5AT Series 2014/5036(inch/mm)

### Appearance/Dimensions

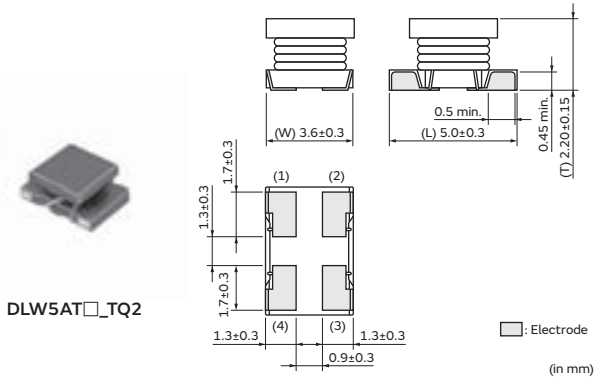

### Packaging

Code	Packaging	Minimum Quantity
K	ø330mm Embossed Tape	2500
L	ø180mm Embossed Tape	700
B	Bulk(Bag)	100

### Equivalent Circuit

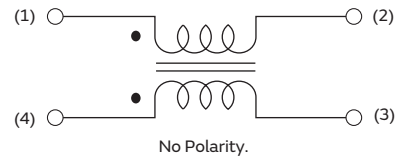

### Appearance/Dimensions

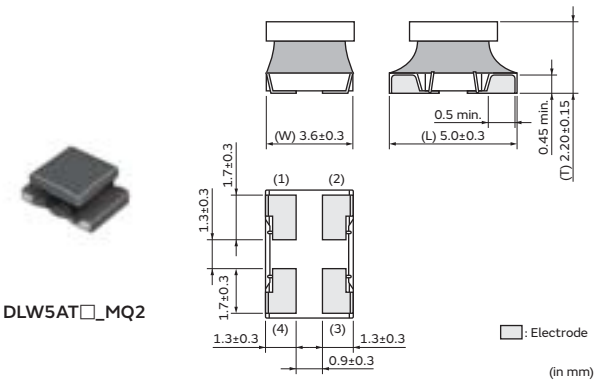

### Rated Value (□: packaging code)

Part Number		Common Mode Impedance at 10MHz	Common Mode Impedance at 100MHz	Rated Current	Rated Voltage	Insulation Resistance (Min.)	Withstanding Voltage	DC Resistance
Infotainment	Powertrain/Safety							
DLW5ATZ450TQ2□	DLW5ATH450TQ2□	4.7Ω±25%	45Ω(Typ.)	4A	50Vdc	10MΩ	125Vdc	0.013Ω max.
DLW5ATZ500MQ2□	DLW5ATH500MQ2□	4.6Ωmin.	50Ω(Typ.)	4A	50Vdc	10MΩ	125Vdc	0.013Ω max.
DLW5ATZ111TQ2□	DLW5ATH111TQ2□	12Ω±25%	110Ω(Typ.)	3A	50Vdc	10MΩ	125Vdc	0.020Ω max.
DLW5ATZ151MQ2□	DLW5ATH151MQ2□	11Ωmin.	150Ω(Typ.)	3A	50Vdc	10MΩ	125Vdc	0.020Ω max.
DLW5ATZ231TQ2□	DLW5ATH231TQ2□	22Ω±25%	230Ω(Typ.)	2.5A	50Vdc	10MΩ	125Vdc	0.027Ω max.
DLW5ATZ331MQ2□	DLW5ATH331MQ2□	20Ωmin.	330Ω(Typ.)	2.5A	50Vdc	10MΩ	125Vdc	0.027Ω max.
DLW5ATZ401TQ2□	DLW5ATH401TQ2□	35Ω±25%	400Ω(Typ.)	2A	50Vdc	10MΩ	125Vdc	0.034Ω max.
DLW5ATZ501MQ2□	DLW5ATH501MQ2□	35Ωmin.	500Ω(Typ.)	2A	50Vdc	10MΩ	125Vdc	0.034Ω max.
DLW5ATZ501TQ2□	DLW5ATH501TQ2□	55Ω±25%	500Ω(Typ.)	1.5A	50Vdc	10MΩ	125Vdc	0.056Ω max.
DLW5ATZ112MQ2□	DLW5ATH112MQ2□	50Ωmin.	1100Ω(Typ.)	1.5A	50Vdc	10MΩ	125Vdc	0.056Ω max.

Operating Temp. Range: -40°C to 105°C/-40°C to 125°C

Continued on the following page. ↗

SMD Type  
Chip Ferrite Bead

SMD Type  
Chip EMIFIL®

SMD Type  
Chip Common Mode Choke Coil

SMD Type  
Block Type EMIFIL®

Lead Type  
EMI Suppression Filters

SMD Type  
Microchip Transformer (Balun)

Continued from the preceding page. ↘

**Z-f characteristics: DLW5ATZ\_TQ2 series**

**Z-f characteristics: DLW5ATH\_TQ2 series**

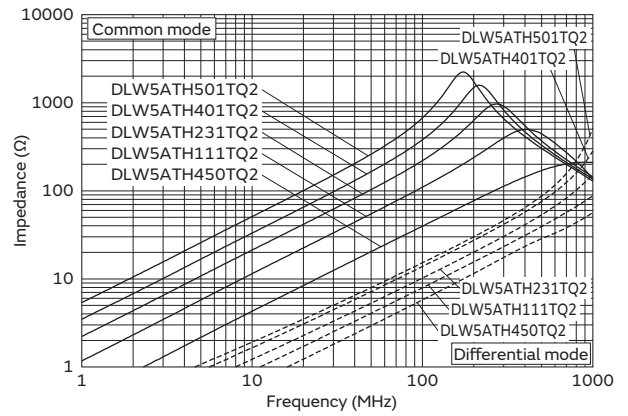
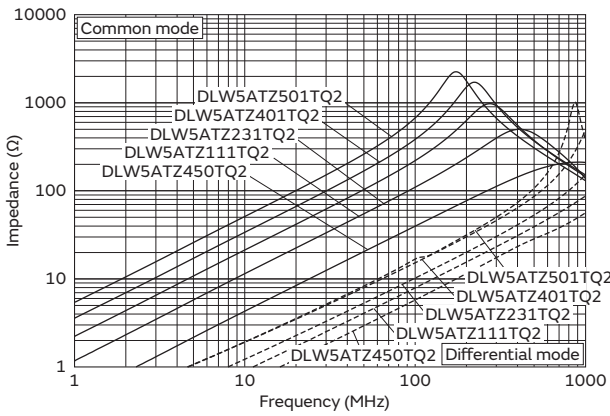

**Z-f characteristics: DLW5ATZ\_MQ2 series**

**Z-f characteristics: DLW5ATH\_MQ2 series**

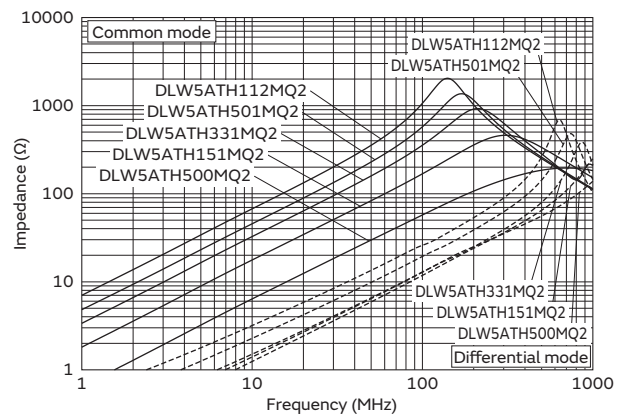
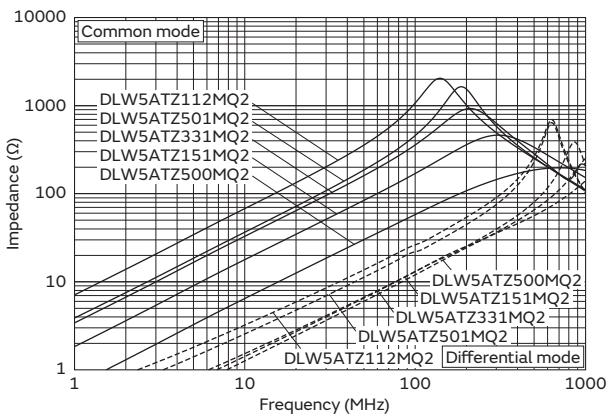

Continued on the following page. ↗

Chip Ferrite Bead  
 SMD Type

Chip EMI FIL®  
 SMD Type

Chip Common Mode Choke Coil  
 SMD Type

Block Type EMI FIL®  
 SMD Type

EMI Suppression Filters  
 Lead Type

Microchip Transformer (Balun)  
 SMD Type

Continued from the preceding page. ↘

### Derating of Rated Current

In operating temperature exceeding +105°C, derating of current is necessary for DLW5ATH\_TQ2 series. Please apply the derating curve shown in chart according to the operating temperature.

Derating of Rated Current

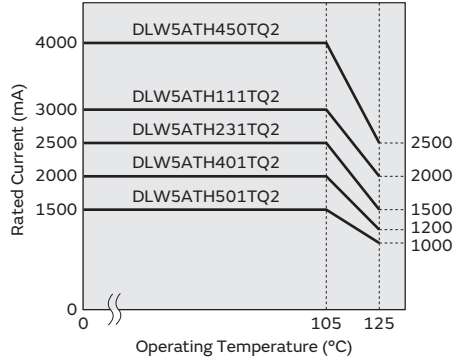

### Derating of Rated Current

In operating temperature exceeding +105°C, derating of current is necessary for DLW5ATH\_MQ2 series. Please apply the derating curve shown in chart according to the operating temperature.

Derating of Rated Current

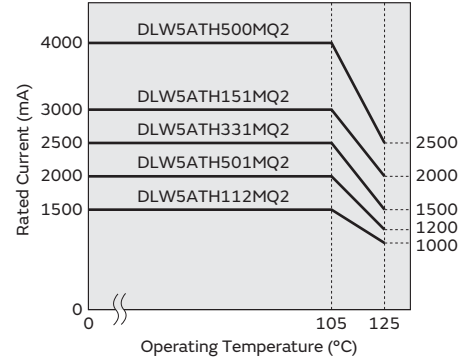

SMD Type  
 Chip Ferrite Bead

SMD Type  
 Chip EMIFIL®

SMD Type  
 Chip Common Mode Choke Coil

SMD Type  
 Block Type EMIFIL®

Lead Type  
 EMI Suppression Filters

SMD Type  
 Microchip Transformer (Balun)

# Chip Common Mode Choke Coil SMD Type

## DLW5BS Series 2020/5050(inch/mm)

### Appearance/Dimensions

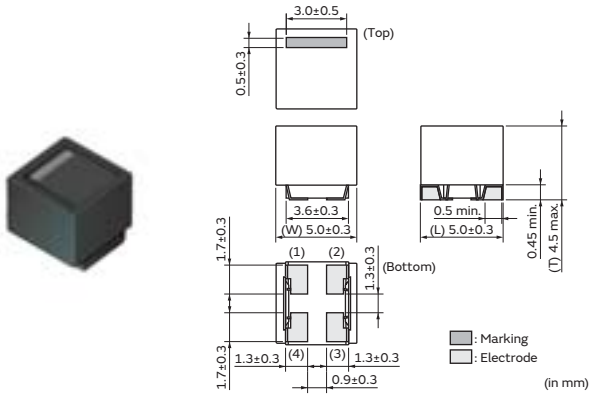

### Packaging

Code	Packaging	Minimum Quantity
K	ø330mm Embossed Tape	1500
L	ø180mm Embossed Tape	400
B	Bulk(Bag)	100

### Equivalent Circuit

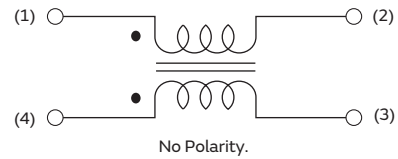

### Rated Value (□: packaging code)

Part Number		Common Mode Impedance at 10MHz	Common Mode Impedance at 100MHz	Rated Current	Rated Voltage	Insulation Resistance (Min.)	Withstanding Voltage	DC Resistance
Infotainment	Powertrain/Safety							
DLW5BSZ501TQ2□	—	2800Ω±40%	500Ω(Typ.)	700mA	50Vdc	10MΩ	125Vdc	0.23Ω max.
DLW5BSZ601TQ2□	—	1200Ω±40%	600Ω(Typ.)	1A	50Vdc	10MΩ	125Vdc	0.12Ω max.
DLW5BSZ801TQ2□	—	550Ω±40%	800Ω(Typ.)	1.5A	50Vdc	10MΩ	125Vdc	0.056Ω max.

Operating Temp. Range: -40°C to 105°C

### Z-f characteristics: DLW5BSZ\_TQ2 series

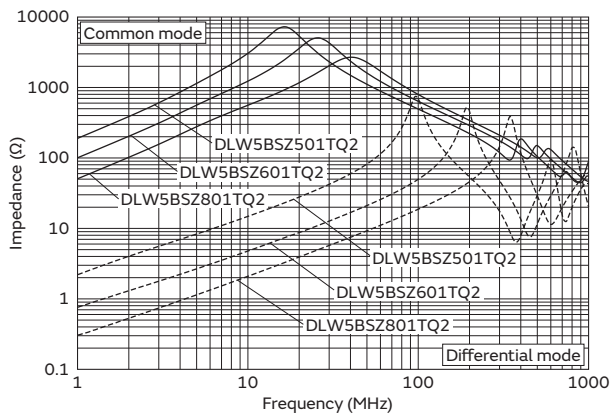

# Chip Common Mode Choke Coil SMD Type

## DLW5BT Series 2020/5050(inch/mm)

### Appearance/Dimensions

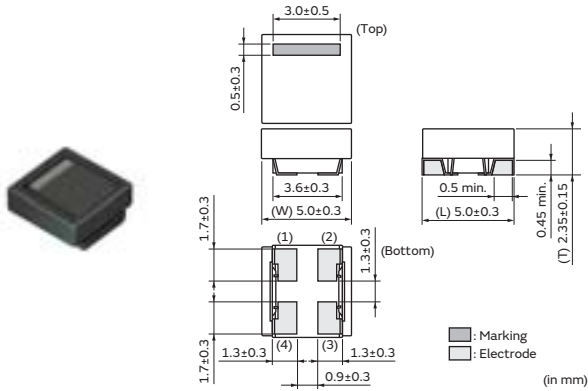

### Packaging

Code	Packaging	Minimum Quantity
K	ø330mm Embossed Tape	2500
L	ø180mm Embossed Tape	700
B	Bulk(Bag)	100

### Equivalent Circuit

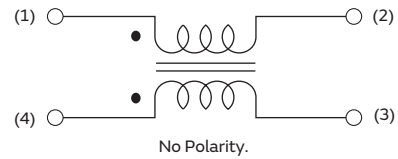

### Rated Value (□: packaging code)

Part Number		Common Mode Impedance at 10MHz	Common Mode Impedance at 100MHz	Rated Current	Rated Voltage	Insulation Resistance (Min.)	Withstanding Voltage	DC Resistance
Infotainment	Powertrain/Safety							
DLW5BTZ101TQ2□	DLW5BTH101TQ2□	10Ωmin.	100Ω(Typ.)	4A	50Vdc	10MΩ	125Vdc	0.013Ω max.
DLW5BTZ251TQ2□	DLW5BTH251TQ2□	20Ωmin.	250Ω(Typ.)	3A	50Vdc	10MΩ	125Vdc	0.020Ω max.
DLW5BTZ501TQ2□	DLW5BTH501TQ2□	30Ωmin.	500Ω(Typ.)	2.5A	50Vdc	10MΩ	125Vdc	0.027Ω max.
DLW5BTZ102TQ2□	DLW5BTH102TQ2□	60Ωmin.	1000Ω(Typ.)	2A	50Vdc	10MΩ	125Vdc	0.034Ω max.
DLW5BTZ142TQ2□	DLW5BTH142TQ2□	100Ωmin.	1400Ω(Typ.)	1.5A	50Vdc	10MΩ	125Vdc	0.056Ω max.

Operating Temp. Range: -40°C to 105°C/-40°C to 125°C

### Z-f characteristics: DLW5BTZ\_TQ2 series

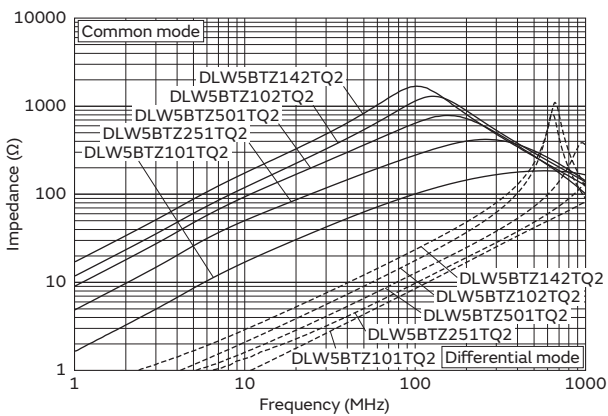

### Z-f characteristics: DLW5BTH\_TQ2 series

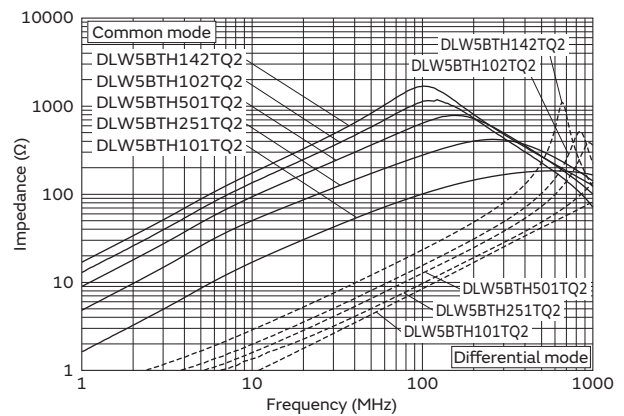

Continued on the following page. ↗

Continued from the preceding page. ↘

## Derating of Rated Current

In operating temperature exceeding +105°C, derating of current is necessary for DLW5BTH\_TQ2 series.  
 Please apply the derating curve shown in chart according to the operating temperature.

Derating of Rated Current

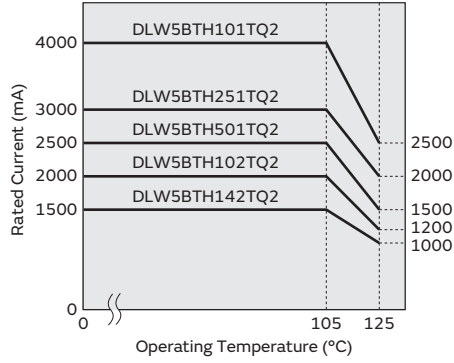

Chip Ferrite Bead  
 SMD Type

Chip EMIFIL®  
 SMD Type

Chip Common Mode Choke Coil  
 SMD Type

Block Type EMIFIL®  
 SMD Type

EMI Suppression Filters  
 Lead Type

Microchip Transformer (Balun)  
 SMD Type

# Chip Common Mode Choke Coil SMD Type

## PLT5BP Series 2020/5050(inch/mm)

### Appearance/Dimensions

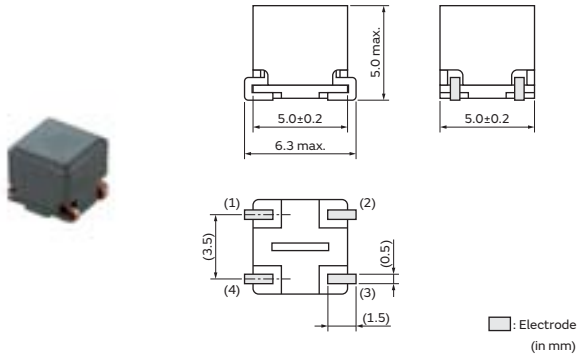

### Packaging

Code	Packaging	Minimum Quantity
L	ø180mm Embossed Tape	300
B	Bulk(Bag)	50

### Equivalent Circuit

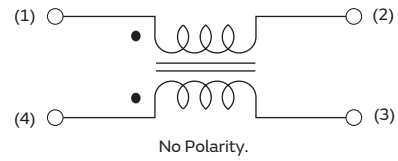

### Rated Value (□: packaging code)

Part Number		Common Mode Impedance at 10MHz	Rated Current	Rated Voltage	Insulation Resistance (Min.)	Withstanding Voltage	DC Resistance
Infotainment	Powertrain/Safety						
—	PLT5BPH1015R6SN□	100Ω(Typ.)	5.6A	80Vdc	10MΩ	200Vdc	4mΩ±30%
—	PLT5BPH2014R4SN□	200Ω(Typ.)	4.4A	80Vdc	10MΩ	200Vdc	7mΩ±30%
—	PLT5BPH3013R7SN□	300Ω(Typ.)	3.7A	80Vdc	10MΩ	200Vdc	11mΩ±30%
—	PLT5BPH5013R1SN□	500Ω(Typ.)	3.1A	80Vdc	10MΩ	200Vdc	17mΩ±30%

Operating Temp. Range: -55°C to 150°C

### Z-f characteristics: PLT5BPH series

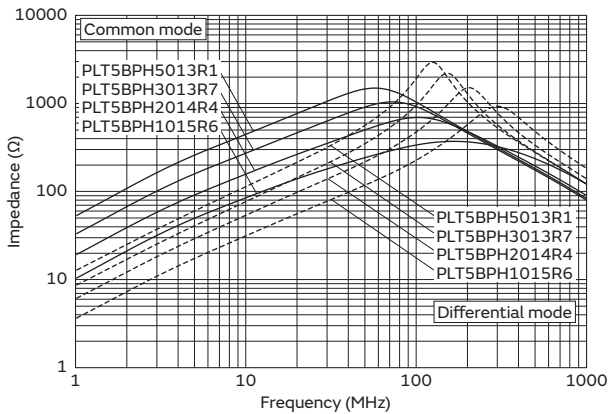

Continued on the following page. ↗

Continued from the preceding page. ↘

## Derating of Rated Current

In operating temperature exceeding +125°C, derating of current is necessary for PLT5BP series.  
Please apply the derating curve shown in chart according to the operating temperature.

Derating of Rated Current

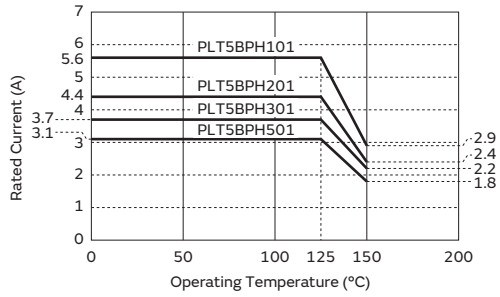

Chip Ferrite Bead  
SMD Type

Chip EMIFIL®  
SMD Type

Chip Common Mode Choke Coil  
SMD Type

Block Type EMIFIL®  
SMD Type

EMI Suppression Filters  
Lead Type

Microchip Transformer (Balun)  
SMD Type



# Chip Common Mode Choke Coil SMD Type

## PLT10H Series

### Appearance/Dimensions

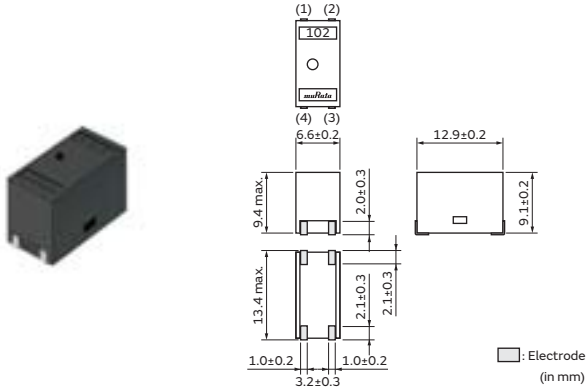

### Packaging

Code	Packaging	Minimum Quantity
K	ø330mm Embossed Tape	500
L	ø180mm Embossed Tape	125
B	Bulk(Bag)	50

### Equivalent Circuit

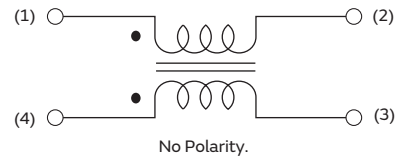

### Rated Value (□: packaging code)

Part Number		Common Mode Impedance at 10MHz	Common Mode Inductance	Rated Current	Rated Voltage	Insulation Resistance (Min.)	Withstanding Voltage	DC Resistance	Operating Temp. Range
Infotainment	Powertrain/Safety								
—	PLT10HH450180PN□	45Ω(Typ.)	0.8μHmin.	18A	300Vdc	10MΩ	750Vdc	1.3mΩ±0.5mΩ	-55°C to 125°C
—	PLT10HH101150PN□	100Ω(Typ.)	2.0μHmin.	15A	300Vdc	10MΩ	750Vdc	1.8mΩ±0.5mΩ	-55°C to 125°C
—	PLT10HH401100PN□	400Ω(Typ.)	6μHmin.	10A	100Vdc	10MΩ	250Vdc	3.6mΩ±0.5mΩ	-55°C to 125°C
—	PLT10HH501100PN□	500Ω(Typ.)	9μHmin.	10A	100Vdc	10MΩ	250Vdc	3.6mΩ±0.5mΩ	-55°C to 105°C
—	PLT10HH9016R0PN□	900Ω(Typ.)	14μHmin.	6A	100Vdc	10MΩ	250Vdc	8.0mΩ±0.5mΩ	-55°C to 125°C
—	PLT10HH1026R0PN□	1000Ω(Typ.)	20μHmin.	6A	100Vdc	10MΩ	250Vdc	8.0mΩ±0.5mΩ	-55°C to 105°C

Operating temperature should include self-temperature rise.

### Z-f characteristics: PLT10HH series

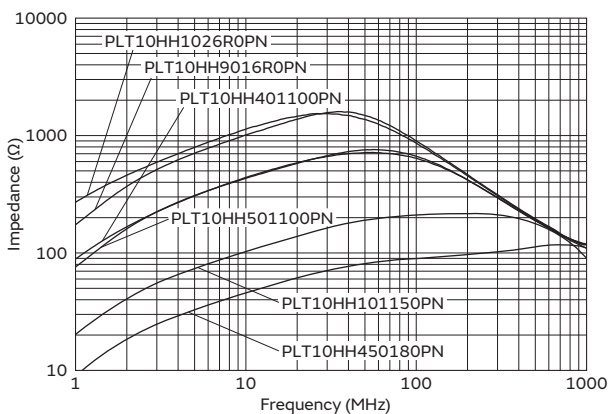

Continued on the following page. ↗

Continued from the preceding page. ↘

## Derating of Rated Current

In operating temperature exceeding +65°C, derating of current is necessary for PLT10H series.  
Please apply the derating curve shown in chart according to the operating temperature.

Derating of Rated Current

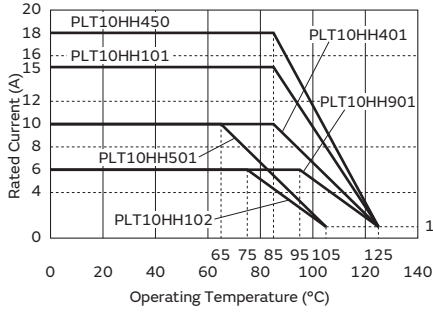

Chip Ferrite Bead  
SMD Type

Chip EMIFIL®  
SMD Type

Chip Common Mode Choke Coil  
SMD Type

Block Type EMIFIL®  
SMD Type

EMI Suppression Filters  
Lead Type

Microchip Transformer (Balun)  
SMD Type

# Chip Common Mode Choke Coil SMD Type

## UCMH0907 Series 3527/9070(inch/mm)

### Appearance/Dimensions

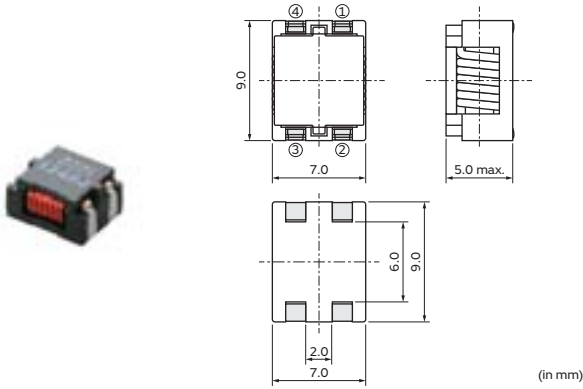

### Packaging

Code	Packaging	Minimum Quantity
=P3	ø330mm Embossed Tape	750

### Equivalent Circuit

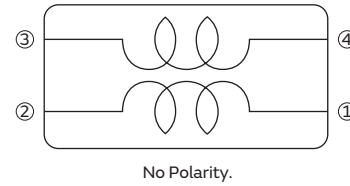

### Rated Value (□: packaging code)

Part Number		Common Mode Impedance at 100MHz	Rated Current	Rated Voltage	Insulation Resistance (Min.)	Withstanding Voltage	DC Resistance
Infotainment	Powertrain/Safety						
1259CM-0001□	—	700Ω(Typ.)	5A	50Vdc	100MΩ	100Vdc	0.01Ω max.

Operating Temp. Range: -40°C to 125°C

Operating temperature should include self-temperature rise.

### Z-f characteristics: UCMH0907 series

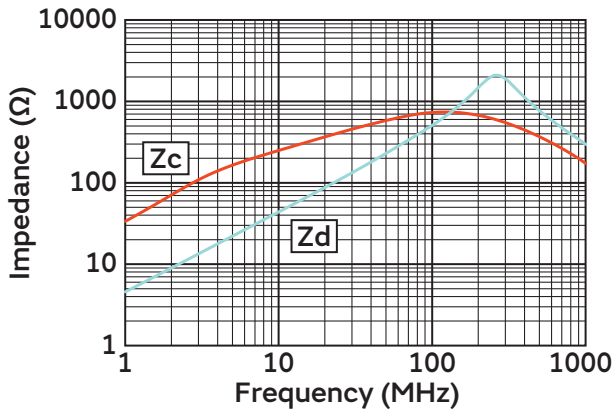

### Insertion loss: UCMH0907 series

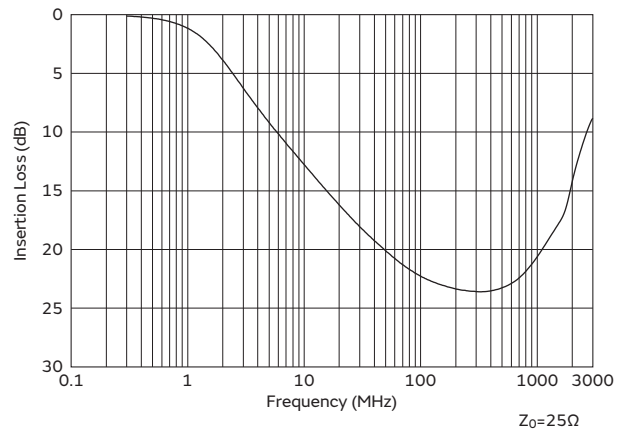

SMD Type  
 Chip Ferrite Bead

SMD Type  
 Chip EMIFIL®

SMD Type  
 Chip Common Mode Choke Coil

SMD Type  
 Block Type EMIFIL®

Lead Type  
 EMI Suppression Filters

SMD Type  
 Microchip Transformer (Balun)

## Chip Common Mode Choke Coil (DL□ Series) ⚠️Caution/Notice

### ⚠️Caution

#### Rating

Do not use products beyond the rated current and rated voltage as this may create excessive heat and deteriorate the insulation resistance. Be sure to provide an appropriate fail-safe function on your product to prevent a second damage that may be caused by the abnormal function or the failure our product.

#### Soldering and Mounting

##### 1. Self-heating

Please provide special attention when mounting chip common mode choke coils DLW5 series in close proximity to other products that radiate heat. The heat generated by other products may deteriorate the insulation resistance and cause excessive heat in this component.

##### 2. Mounting Direction

Mount Chip Common Mode Choke Coils in right direction. Wrong direction, which is 90 degrees rotated from right

direction, causes not only open or short circuit but also flames or other serious trouble.

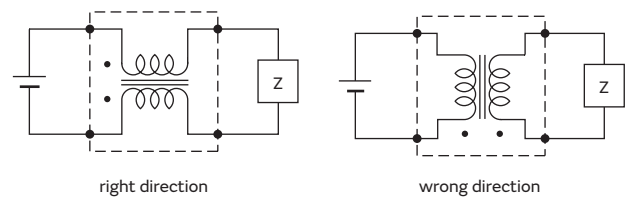

### Notice

#### Storage and Operating Condition

##### <Operating Environment>

Do not use products in the corrodible atmosphere such as acidic gases, alkaline gases, chlorine, sulfur gases, organic gases. (the sea breeze, Cl<sub>2</sub>, H<sub>2</sub>S, NH<sub>3</sub>, SO<sub>2</sub>, NO<sub>2</sub>, etc)

Do not use products in the environment close to the organic solvent.

##### <Storage and Handling Requirements>

##### 1. Storage Period

The DL series should be used within 12 months. Solderability should be checked if this period is exceeded.

##### 2. Storage Conditions

- (1) Storage temperature: -10 to +40°C  
Relative humidity: 15 to 85%  
Avoid sudden changes in temperature and humidity.
- (2) Do not store products in a chemical atmosphere such as chlorine gas, acid or sulfide gas.

#### Notice (Soldering and Mounting)

##### 1. Cleaning

Failure and degradation of a product are caused by the cleaning method. When you clean in conditions that are not in mounting information, please contact Murata engineering.

##### 2. Soldering

Reliability decreases with improper soldering methods. Please solder by the standard soldering conditions shown in mounting information.

##### 3. Other

Noise suppression levels resulting from Murata's EMI suppression filters EMIFIL® may vary, depending on the circuits and ICs used, type of noise, mounting pattern, mounting location, and other operating conditions. Be sure to check and confirm in advance the noise suppression effect of each filter, in actual circuits, etc. before applying the filter in a commercial-purpose equipment design.

Continued on the following page. ↗

## Chip Common Mode Choke Coil (DL□ Series) ⚠Caution/Notice

Continued from the preceding page. ↘

### Handling

#### 1. Resin Coating (Except for DLW Series.)

Using resin for coating/molding products may affect the products performance.

So please pay careful attention in selecting resin.

Prior to use, please make the reliability evaluation with the product mounted in your application set.

#### 2. Resin Coating (DLW31S Series)

Do not make any resin coating DLW31S series.

The impedance value may change due to high cure-stress of resin to be used for coating/molding products.

An open circuit issue may occur by mechanical stress caused by the resin, amount/cured shape of resin, or operating condition etc. Some resin contains some impurities or chloride possible to generate chlorine by hydrolysis under some operating condition may cause corrosion of wire of coil, leading to open circuit.

So, please pay your careful attention in selecting resin in case of coating/molding the products with the resin.

#### 3. Resin Coating (Except DLW31S Series)

The impedance value may change due to high cure-stress of resin to be used for coating/molding products. An open circuit issue may occur by mechanical stress caused by the resin, amount/cured shape of resin, or operating condition etc. Some resin contains some impurities or chloride possible to generate chlorine by hydrolysis under some operating condition may cause corrosion of wire of coil, leading to open circuit.

So, please pay your careful attention in selecting resin in case of coating/molding the products with the resin. Prior to use the coating resin, please make sure no reliability issue is observed by evaluating products mounted on your board.

#### 4. Caution for Use (DLW Series)

When you hold products with a tweezer, please hold by the sides. Sharp materials, such as a pair of tweezers, should not touch the winding portion to prevent breaking the wire. Mechanical shock should not be applied to the products mounted on the board to prevent breaking the core.

#### 5. Brushing (DLW21S/31S/32S/43S/43M Series)

When you clean the neighborhood of products such as connector pins, bristles of cleaning brush shall not be touched to the winding portion of this product to prevent the breaking of wire.

#### 6. Handling of a Substrate

After mounting products on a substrate, do not apply any stress to the product caused by bending or twisting to the substrate when cropping the substrate, inserting and removing a connector from the substrate or tightening screw to the substrate. Excessive mechanical stress may cause cracking in the Product.

Bending

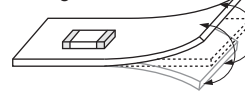

Twisting

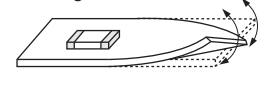

## Chip Common Mode Choke Coil (PL□ Series) ⚠️Caution/Notice

### ⚠️Caution

#### Rating

1. Do not use products beyond the rated current and rated voltage as this may create excessive heat and deteriorate the insulation resistance.
2. Be sure to provide an appropriate fail-safe function on your product to prevent a second damage that may be caused by the abnormal function or the failure our product.

#### Soldering and Mounting

1. Self-heating  
 Please provide special attention when mounting chip common mode choke coils in close proximity to other products that radiate heat.  
 The heat generated by other products may deteriorate the insulation resistance and cause excessive heat in this component.
2. Mounting Direction  
 Mount Chip Common Mode Choke Coils in right direction.

Wrong direction, which is 90 degrees rotated from right direction, causes not only open or short circuit but also flames or other serious trouble.

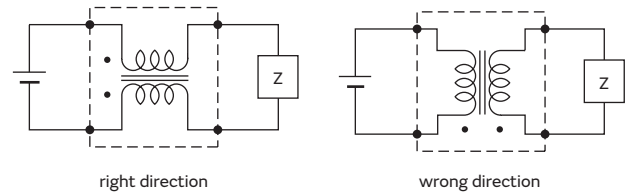

### Notice

#### Storage and Operating Condition

##### <Operating Environment>

Do not use products in a chemical atmosphere such as chlorine gas, acid or sulfide gas.

Do not use products in the environment close to the organic solvent.

##### <Storage and Handling Requirements>

1. Storage Period  
 PLT10H series, PLT5BP series should be used within 12 months.

Solderability should be checked if this period is exceeded.

##### 2. Storage Conditions

- (1) Storage temperature: -10 to +40°C  
 Relative humidity: 15 to 85%  
 Avoid sudden changes in temperature and humidity.
- (2) Do not store products in a chemical atmosphere such as chlorine gas, acid or sulfide gas.

#### Notice (Soldering and Mounting)

1. Cleaning  
 Failure and degradation of a product are caused by the cleaning method. When you clean in conditions that are not in mounting information, please contact Murata engineering.
2. Soldering  
 Reliability decreases with improper soldering methods. Please solder by the standard soldering conditions shown in mounting information.

##### 3. Other

Noise suppression levels resulting from Murata's EMI suppression filters EMIFIL® may vary, depending on the circuits and ICs used, type of noise, mounting pattern, mounting location, and other operating conditions. Be sure to check and confirm in advance the noise suppression effect of each filter, in actual circuits, etc. before applying the filter in a commercial-purpose equipment design.

#### Handling

1. Handling of a Substrate  
 After mounting products on a substrate, do not apply any stress to the product caused by bending or twisting to the substrate when cropping the substrate, inserting and removing a connector from the substrate or tightening screw to the substrate.

Excessive mechanical stress may cause cracking in the Product.



## Chip Common Mode Choke Coil (UCMH□ Series) ⚠️Caution/Notice

### ⚠️Caution

#### Rating

Do not use products beyond the rated current and rated voltage as this may create excessive heat and deteriorate the insulation resistance. Be sure to provide an appropriate fail-safe function on your product to prevent a second damage that may be caused by the abnormal function or the failure our product.

#### Soldering and Mounting

##### 1. Self-heating

Please provide special attention when mounting this product close to other products that radiate heat. The heat generated by other products may deteriorate the insulation resistance and cause excessive heat in this component.

##### 2. Mounting Direction

Mount Chip Common Mode Choke Coils in right direction. Wrong direction, which is 90 degrees rotated from right direction, causes not only open or short circuit but also flames or other serious trouble.

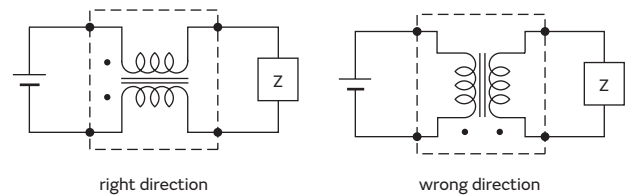

### Notice

#### Handling

##### 1. Resin Coating

The inductance value may change and / or it may affect on the product's performance due to high cure-stress of resin to be used for coating / molding products. So please pay your careful attention when you select resin. In prior to use, please make the reliability evaluation with the product mounted in your application set.

# Chip Common Mode Choke Coil (DL□ Series) Soldering and Mounting

## 1. Standard Land Pattern Dimensions

(in mm)

Series	Standard Land Dimensions																																				
DLM11S DLW21S DLW31S DLW32S DLW43S DLW43M DLW5A DLW5B	<b>●Reflow Soldering</b> 	<table border="1"> <thead> <tr> <th>Series</th> <th>a</th> <th>b</th> <th>c</th> <th>d</th> </tr> </thead> <tbody> <tr> <td>DLW21S/H</td> <td>0.8</td> <td>2.6</td> <td>0.4</td> <td>1.2</td> </tr> <tr> <td>DLW31S</td> <td>1.6</td> <td>3.7</td> <td>0.4</td> <td>1.6</td> </tr> <tr> <td>DLW32S</td> <td>2.0</td> <td>4.1</td> <td>0.4</td> <td>1.6</td> </tr> <tr> <td>DLW43SH110/220/510</td> <td>3.0</td> <td>5.9</td> <td>1.6</td> <td>3.4</td> </tr> <tr> <td>DLW43SH101</td> <td>3.2</td> <td>5.9</td> <td>1.6</td> <td>3.4</td> </tr> <tr> <td>DLW43MH</td> <td>3.5</td> <td>5.9</td> <td>0.7</td> <td>2.1</td> </tr> </tbody> </table>	Series	a	b	c	d	DLW21S/H	0.8	2.6	0.4	1.2	DLW31S	1.6	3.7	0.4	1.6	DLW32S	2.0	4.1	0.4	1.6	DLW43SH110/220/510	3.0	5.9	1.6	3.4	DLW43SH101	3.2	5.9	1.6	3.4	DLW43MH	3.5	5.9	0.7	2.1
	Series	a	b	c	d																																
DLW21S/H	0.8	2.6	0.4	1.2																																	
DLW31S	1.6	3.7	0.4	1.6																																	
DLW32S	2.0	4.1	0.4	1.6																																	
DLW43SH110/220/510	3.0	5.9	1.6	3.4																																	
DLW43SH101	3.2	5.9	1.6	3.4																																	
DLW43MH	3.5	5.9	0.7	2.1																																	
DLW5A/5B (Except for DLW5AT_MQ2)		<p>*1: If the pattern is made with wider than 1.2mm (DLW21) / 1.6mm (DLW31S) it may result in components turning around, because melting speed is different. In the worst case, short circuit between lines may occur.</p> <p>*2: If the pattern is made with less than specified dimensions, in the worst case, short circuit between lines may occur due to spread of soldering paste or mount placing accuracy.</p> <p>*3: If the pattern is made with wider than 0.8mm (DLW21) / 1.6mm (DLW31SN), the bending strength will be reduced. Moreover, if the pattern is made with less than "a" dimension, in the worst case short circuit may be occurred. (DLW43S)</p> <p>Do not use gild pattern; excess soldering heat may dissolve metal of a copper wire.</p>																																			
DLW5AT_MQ2	<b>●Reflow Soldering Chip Mounting Side</b> 	<b>●Flow Soldering Chip Mounting Side</b> 																																			

### ● PCB Warping

PCB should be designed so that products are not subjected to the mechanical stress caused by warping the board.

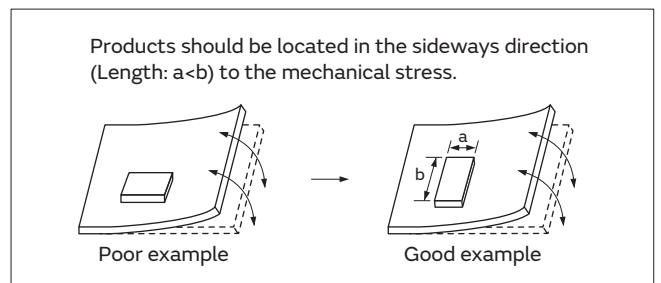

Continued on the following page. ↗

Chip Ferrite Bead  
SMD Type

Chip EMIFIL®  
SMD Type

Chip Common Mode Choke Coil  
SMD Type

Block Type EMIFIL®  
SMD Type

EMI Suppression Filters  
Lead Type

Microchip Transformer (Balun)  
SMD Type



## Chip Common Mode Choke Coil (DL□ Series) Soldering and Mounting

Continued from the preceding page. ↘

### 2. Solder Paste Printing and Adhesive Application

When reflow soldering the chip common mode choke coils, the printing must be conducted in accordance with the following cream solder printing conditions.

If too much solder is applied, the chip will be prone to damage by mechanical and thermal stress from the PCB and may crack.

Standard land dimensions should be used for resist and copper foil patterns.

When flow soldering the chip common mode choke coils, apply the adhesive in accordance with the following conditions.

If too much adhesive is applied, then it may overflow into the land or termination areas and yield poor solderability. In contrast, if insufficient adhesive is applied, or if the adhesive is not sufficiently hardened, then the chip may become detached during flow soldering process.

(in mm)

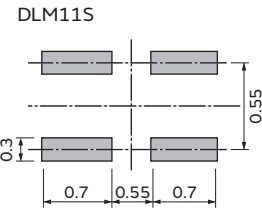
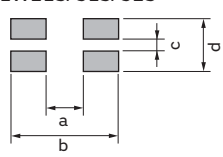
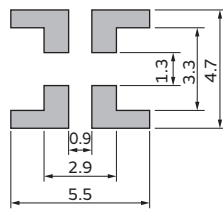
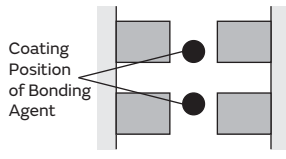
Series	Solder Paste Printing	Adhesive Application																				
<b>DLW DLM</b>	<p>●Guideline of solder paste thickness:                      100-150μm: DLW21S/31S/32S, DLM11S                      150μm: DLW43S                      150-200μm: DLW5A/5B</p> <p>*Solderability is subject to reflow conditions and thermal conductivity. Please make sure that your product has been evaluated in view of your specifications with our product being mounted to your product.</p> <p>DLM11S</p>  <p>DLW21S/31S/32S</p>  <table border="1" data-bbox="646 1198 1117 1332"> <thead> <tr> <th>Series</th> <th>a</th> <th>b</th> <th>c</th> <th>d</th> </tr> </thead> <tbody> <tr> <td>DLW21S</td> <td>0.8</td> <td>2.6</td> <td>0.5</td> <td>1.2</td> </tr> <tr> <td>DLW31S</td> <td>1.6</td> <td>3.7</td> <td>0.4</td> <td>1.6</td> </tr> <tr> <td>DLW32S</td> <td>2.0</td> <td>4.1</td> <td>0.4</td> <td>1.6</td> </tr> </tbody> </table> <p>DLW5A/5B</p> 	Series	a	b	c	d	DLW21S	0.8	2.6	0.5	1.2	DLW31S	1.6	3.7	0.4	1.6	DLW32S	2.0	4.1	0.4	1.6	<p>■DLW5AT_MQ2                      Apply 0.3mg of bonding agent at each chip.</p> <p>DLW5AT_MQ2</p> 
Series	a	b	c	d																		
DLW21S	0.8	2.6	0.5	1.2																		
DLW31S	1.6	3.7	0.4	1.6																		
DLW32S	2.0	4.1	0.4	1.6																		

Continued on the following page. ↗

SMD Type  
 Chip Ferrite Bead

SMD Type  
 Chip EMIFIL®

SMD Type  
 Chip Common Mode Choke Coil

SMD Type  
 Block Type EMIFIL®

Lead Type  
 EMI Suppression Filters

SMD Type  
 Microchip Transformer (Balun)

## Chip Common Mode Choke Coil (DL□ Series) Soldering and Mounting

Continued from the preceding page. ↘

### 3. Standard Soldering Conditions

#### (1) Soldering Methods

Use flow and reflow soldering methods only.  
 Use standard soldering conditions when soldering chip common mode choke coils.  
 In cases where several different parts are soldered, each having different soldering conditions, use those conditions requiring the least heat and minimum time.

**Solder:** Use Sn-3.0Ag-0.5Cu solder. Use of Sn-Zn based solder will deteriorate performance of products.  
 If using DLM series with Sn-Zn based solder, please contact Murata in advance.

#### Flux:

- Use Rosin-based flux.  
 In case of DLW21/31/43 series, use Rosin-based flux with converting chlorine content of 0.06 to 0.1wt%.  
 In case of using RA type solder, products should be cleaned completely with no residual flux.
- Do not use strong acidic flux (with chlorine content exceeding 0.20wt%)
- Do not use water-soluble flux.

For additional mounting methods, please contact Murata.

#### (2) Soldering Profile

##### ● Flow Soldering Profile (Sn-3.0Ag-0.5Cu Solder)

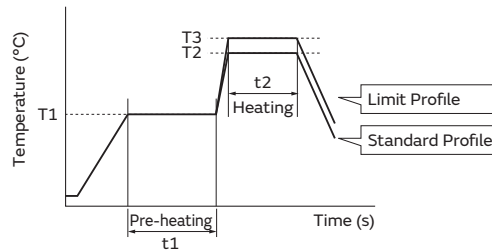

Series	Pre-heating		Standard Profile			Limit Profile		
	Temp. (T1)	Time. (t1)	Heating		Cycle of Flow	Heating		Cycle of Flow
			Temp. (T2)	Time. (t2)		Temp. (T3)	Time. (t2)	
DLW5AT_MQ2	150°C	60s min.	250°C	4 to 6s	2 times max.	265±3°C	5s max.	2 times max.

##### ● Reflow Soldering Profile (Sn-3.0Ag-0.5Cu Solder)

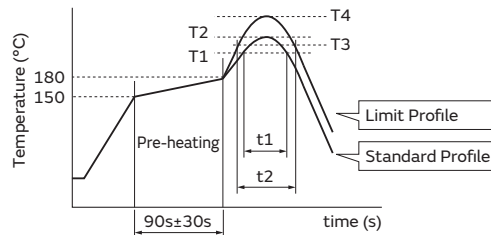

Series	Standard Profile				Limit Profile			
	Heating		Peak Temperature (T2)	Cycle of Reflow	Heating		Peak Temperature (T4)	Cycle of Reflow
	Temp. (T1)	Time. (t1)			Temp. (T3)	Time. (t2)		
DLM/ DLW21S/31S/43MH	220°C min.	30 to 60s	245±3°C	2 times max.	230°C min.	60s max.	260°C/10s	2 times max.
DLW32S/43S	220°C min.	30 to 60s	245±3°C	2 times max.	240°C min.	30s max.	260°C/10s	2 times max.
DLW5A/5B	220°C min.	30 to 60s	250±3°C	2 times max.	230°C min.	60s max.	260°C/10s	2 times max.

Continued on the following page. ↗

## Chip Common Mode Choke Coil (DL□ Series) Soldering and Mounting

Continued from the preceding page. ↘

### (3) Reworking with Solder Iron

The following conditions must be strictly followed when using a soldering iron.

Pre-heating: 150°C 60s min.

Soldering iron power output / Tip diameter:

30W max. / ø3mm max.

Temperature of soldering iron tip / Soldering time /

Times:

350°C max. / 3-4s / 2 times\*<sup>1</sup>

\*<sup>1</sup> DLW31S/DLW43S: 350°C max. / 3s / 2 times

Do not allow the tip of the soldering iron to directly contact the chip.

For additional methods of reworking with a soldering iron, please contact Murata engineering.

## 4. Cleaning

Following conditions should be observed when cleaning chip EMI filter.

Do not clean DLW series.

(1) Cleaning Temperature: 60°C max. (40°C max. for alcohol type cleaner)

(2) Ultrasonic

Output: 20W/liter max.

Duration: 5 minutes max.

Frequency: 28 to 40kHz

### (3) Cleaning agent

The following list of cleaning agents have been tested on the individual components. Evaluation of final assembly should be completed prior to production.

Before cleaning, please contact Murata engineering.

(a) Alcohol cleaning agent

Isopropyl alcohol (IPA)

(b) Aqueous cleaning agent

Pine Alpha ST-100S

(4) Ensure that flux residue is completely removed.

Component should be thoroughly dried after aqueous agent has been removed with deionized water.

# Chip Common Mode Choke Coil (PL□ Series) Soldering and Mounting

## 1. Standard Land Pattern Dimensions

(in mm)

Series	Standard Land Dimensions
<b>PLT10H</b> <b>PLT5BP</b>	<p>●Reflow Soldering</p>

● PCB Warping

PCB should be designed so that products are not subjected to the mechanical stress caused by warping the board.

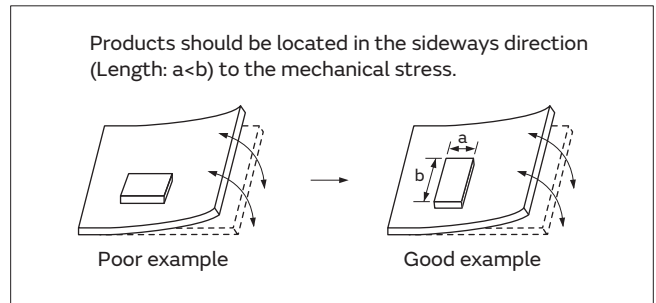

## 2. Solder Paste Printing and Adhesive Application

When reflow soldering the chip common mode choke coils, the printing must be conducted in accordance with the following cream solder printing conditions. If too much solder is applied, the chip will be prone to damage by mechanical and thermal stress from the PCB and may crack.

Standard land dimensions should be used for resist and copper foil patterns.

Series	Solder Paste Printing
<b>PLT10H</b> <b>PLT5BP</b>	<p>●Guideline of solder paste thickness:                      150-200μm: PLT10H                      150μm: PLT5BP                      For the solder paste printing pattern, use standard land dimensions.</p> <p>*Solderability is subject to reflow conditions and thermal conductivity. Please make sure that your product has been evaluated in view of your specifications with our product being mounted to your product.</p>

Continued on the following page. ↗

Chip Ferrite Bead  
SMD Type

Chip EMIFIL®  
SMD Type

Chip Common Mode Choke Coil  
SMD Type

Block Type EMIFIL®  
SMD Type

EMI Suppression Filters  
Lead Type

Microchip Transformer (Balun)  
SMD Type

## Chip Common Mode Choke Coil (PL□ Series) Soldering and Mounting

Continued from the preceding page. ↘

### 3. Standard Soldering Conditions

#### (1) Soldering Methods

Use reflow soldering methods only.  
 Use standard soldering conditions when soldering chip common mode choke coils.  
 In cases where several different parts are soldered, each having different soldering conditions, use those conditions requiring the least heat and minimum time.

Solder: Use Sn-3.0Ag-0.5Cu solder. Use of Sn-Zn based solder will deteriorate performance of products.

Flux:

- Use Rosin-based flux.
- Do not use strong acidic flux (with chlorine content exceeding 0.20wt%)
- Do not use water-soluble flux.

For additional mounting methods, please contact Murata.

#### (2) Soldering Profile

- Reflow Soldering Profile (Sn-3.0Ag-0.5Cu Solder)

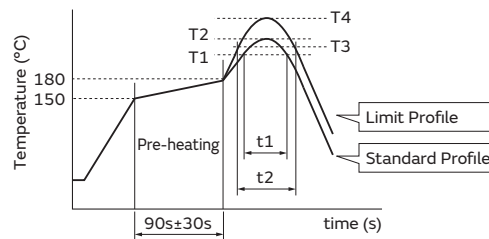

Series	Standard Profile				Limit Profile			
	Heating		Peak Temperature (T2)	Cycle of Reflow	Heating		Peak Temperature (T4)	Cycle of Reflow
	Temp. (T1)	Time. (t1)			Temp. (T3)	Time. (t2)		
PLT10H	220°C min.	30 to 60s	250±3°C	2 times max.	230°C min.	60s max.	260°C/10s	2 times max.
PLT5BP	220°C min.	30 to 60s	245±3°C	2 times max.	240°C min.	30s max.	260°C/10s	2 times max.

#### (3) Reworking with Solder Iron

The following conditions must be strictly followed when using a soldering iron.

Pre-heating: 150°C 60s min.

Soldering iron power output / Tip diameter:

80W max. / ø3mm max.: PLT10HH

30W max. / ø3mm max.: PLT5BP

Temperature of soldering iron tip / Soldering time / Times:

400°C max. / 5s / 2 times: PLT10HH

350°C max. / 3 to 4s / 2 times: PLT5BP

Do not allow the tip of the soldering iron to directly contact the product.

For additional methods of reworking with a soldering iron, please contact Murata engineering.

### 4. Cleaning

Do not clean after soldering.

## Chip Common Mode Choke Coil (UCMH□ Series) Soldering and Mounting

### 1. Standard Land Pattern Dimensions

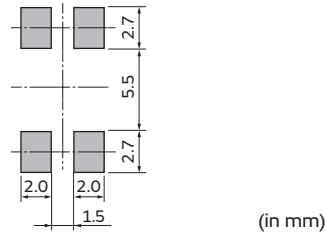

### 2. Standard Soldering Conditions

#### ●Reflow Soldering Condition

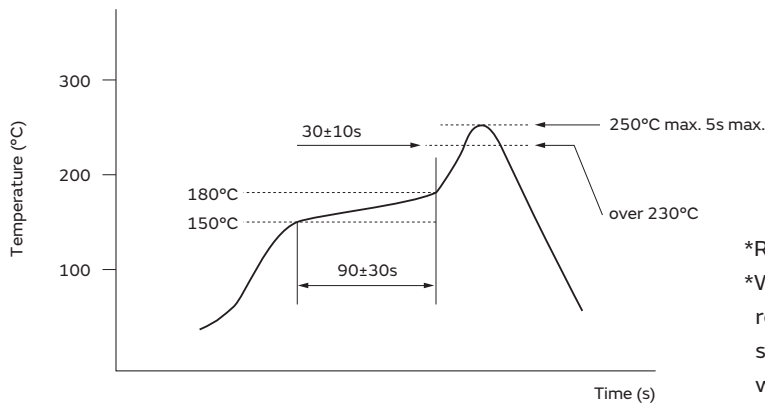

\*Reflow times : 2 times max

\*We recommend infrared ray as heat source of reflow bath. However halogen lamp shall be used, side heat will be beyond range of resistance heat, so we can't recommend it.

## Chip Common Mode Choke Coil (DL□ Series) Packaging

### Minimum Quantity and Dimensions of 8mm Width Embossed Tape

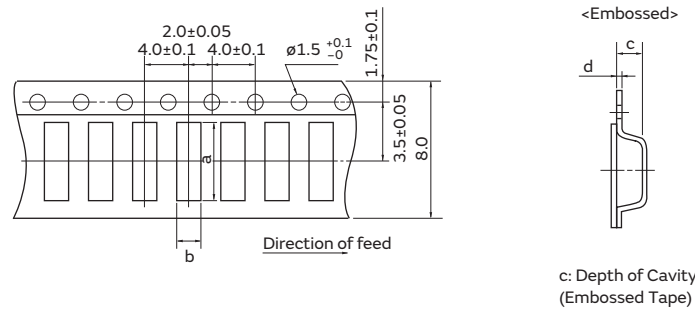

Dimension of the cavity of embossed tape is measured at the bottom side.

Part Number	Dimensions				Minimum Qty. (pcs.)				
					ø180mm Reel		ø330mm Reel		Bulk
	a	b	c	d	Paper Tape	Embossed Tape	Paper Tape	Embossed Tape	
<b>DLM11S</b>	1.4	1.15	0.65	0.25	-	4000	-	-	500
<b>DLW21S</b>	2.25	1.45	1.4	0.3	-	2000	-	-	500
<b>DLW31S</b>	3.6	2.0	2.1	0.3	-	2000	-	-	500
<b>DLW32S</b>	3.6	2.9	2.65	0.3	-	1500	-	-	500

(in mm)

### Minimum Quantity and Dimensions of 12mm Width Embossed Tape

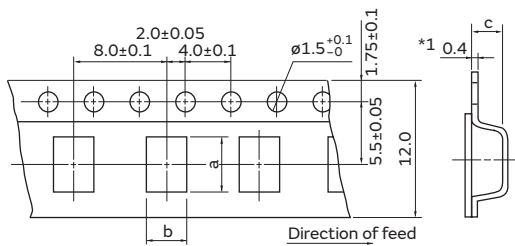

\*1 DLW43/DLW5AT: 0.3 c: Depth of Cavity

Dimension of the cavity is measured at the bottom side.

Part Number	Dimensions			Minimum Qty. (pcs.)		
	a	b	c	ø180mm Reel	ø330mm Reel	Bulk
<b>DLW43SH_XK</b>	4.9	3.6	2.7	500	2500	100
<b>DLW43SH_XP</b>	4.9	3.6	2.9	500	2500	100
<b>DLW5AT</b>	5.4	4.1	2.7	700	2500	100
<b>DLW5BS</b>	5.5	5.4	4.7	400	1500	100
<b>DLW5BT</b>	5.5	5.5	2.7	700	2500	100
<b>DLW43MH</b>	4.9	3.6	3.0	500	2500	100

(in mm)

"Minimum Quantity" means the number of units of each delivery or order. The quantity should be an integral multiple of the "Minimum Quantity."

SMD Type  
 Chip Ferrite Bead

SMD Type  
 Chip EMIFIL®

SMD Type  
 Chip Common Mode Choke Coil

SMD Type  
 Block Type EMIFIL®

Lead Type  
 EMI Suppression Filters

SMD Type  
 Microchip Transformer (Balun)

## Chip Common Mode Choke Coil (PL□ Series) Packaging

### Minimum Quantity and Dimensions of 12mm Width Embossed Tape

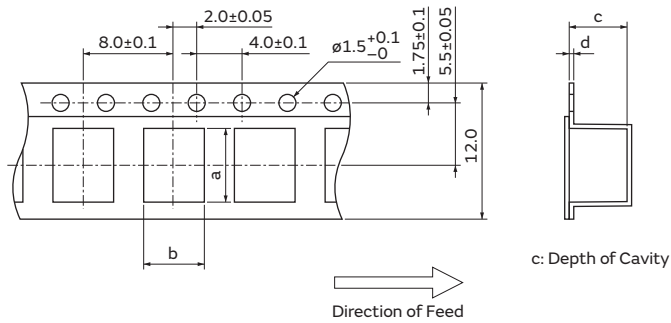

Dimension of the cavity is measured at the bottom side.

Part Number	Dimensions				Minimum Qty. (pcs.)		
	a	b	c	d	ø180mm Reel	ø330mm Reel	Bulk
PLT5BP	6.5	5.35	5.1	0.4	300	-	50

(in mm)

### Minimum Quantity and Dimensions of 24mm Width Embossed Tape

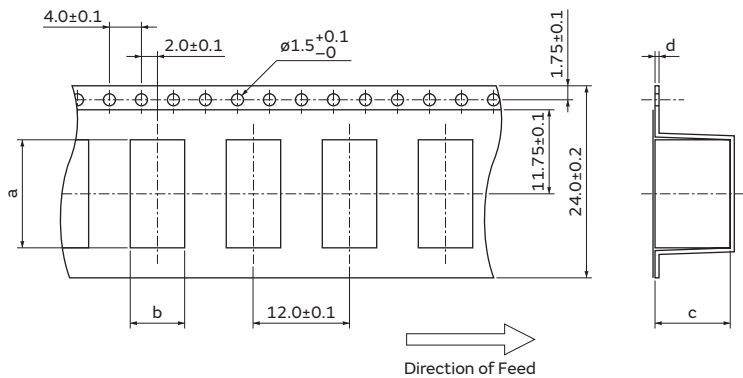

Dimension of the cavity is measured at the bottom side.

Part Number	Dimensions				Minimum Qty. (pcs.)		
	a	b	c	d	ø180mm Reel	ø330mm Reel	Bulk
PLT10H	13.5	6.8	9.4	0.5	125	500	50

(in mm)

Chip Ferrite Bead  
SMD Type

Chip EMIFIL®  
SMD Type

Chip Common Mode Choke Coil  
SMD Type

Block Type EMIFIL®  
SMD Type

EMI Suppression Filters  
Lead Type

Microchip Transformer (Balun)  
SMD Type



## Chip Common Mode Choke Coil (UCMH□ Series) Packaging

### Tape dimensions

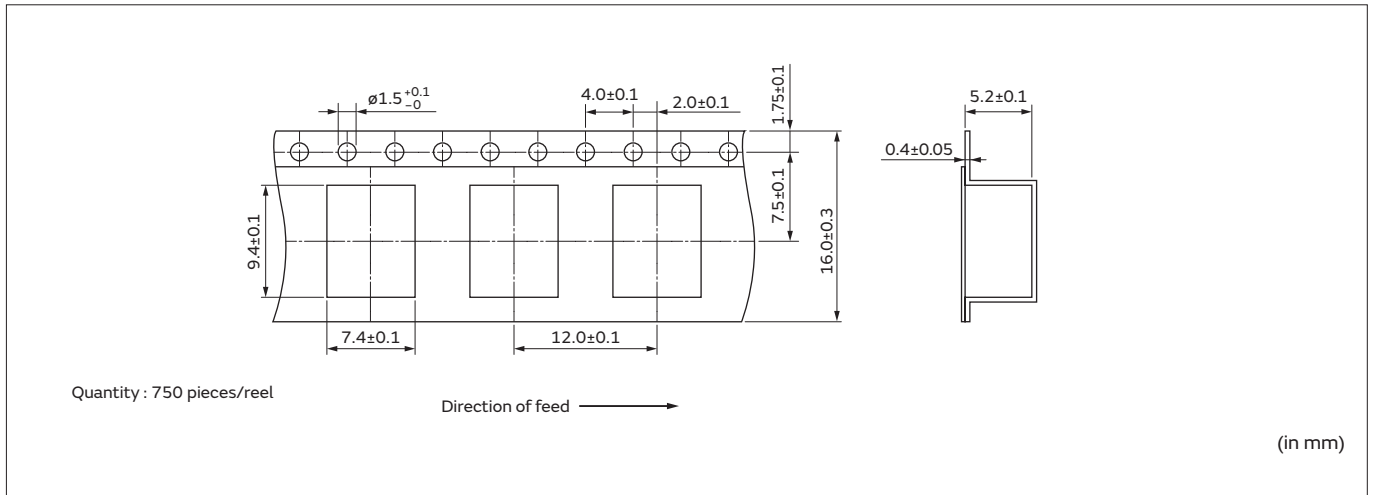

SMD Type  
 Chip Ferrite Bead

SMD Type  
 Chip EMIFIL®

SMD Type  
 Chip Common Mode Choke Coil

SMD Type  
 Block Type EMIFIL®

Lead Type  
 EMI Suppression Filters

SMD Type  
 Microchip Transformer (Balun)

# Block Type EMIFIL®

## BNX02□Series

### Appearance/Dimensions

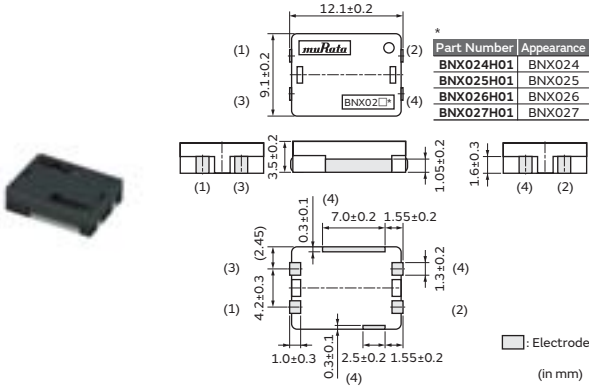

### Packaging

Code	Packaging	Minimum Quantity
L	ø180mm Embossed Taping	400
K	ø330mm Embossed Taping	1500
B	Packing in Bulk	100

### Equivalent Circuit

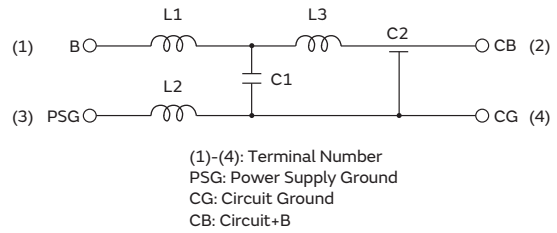

### Rated Value (□: packaging code)

Part Number		Rated Voltage	Withstand Voltage	Rated Current	Insulation Resistance (min.)	Insertion Loss
For Infotainment	For Powertrain/Safety					
—	BNX024H01□	50Vdc	125Vdc	20A	100MΩ	100kHz to 1GHz:35dB min. (Line impedance=50Ω)
—	BNX025H01□	25Vdc	62.5Vdc	20A	50MΩ	50kHz to 1GHz:35dB min. (Line impedance=50Ω)
—	BNX026H01□	50Vdc	125Vdc	20A	10MΩ	50kHz to 1GHz:35dB min. (Line impedance=50Ω)
—	BNX027H01□	16Vdc	40Vdc	20A	1MΩ	40kHz to 1GHz:35dB min. (Line impedance=50Ω)

Operating Temperature Range: -55°C to +125°C  
 In operating temperatures exceeding +85°C, derating of current is necessary.

### Insertion Loss Characteristics (Main Items)

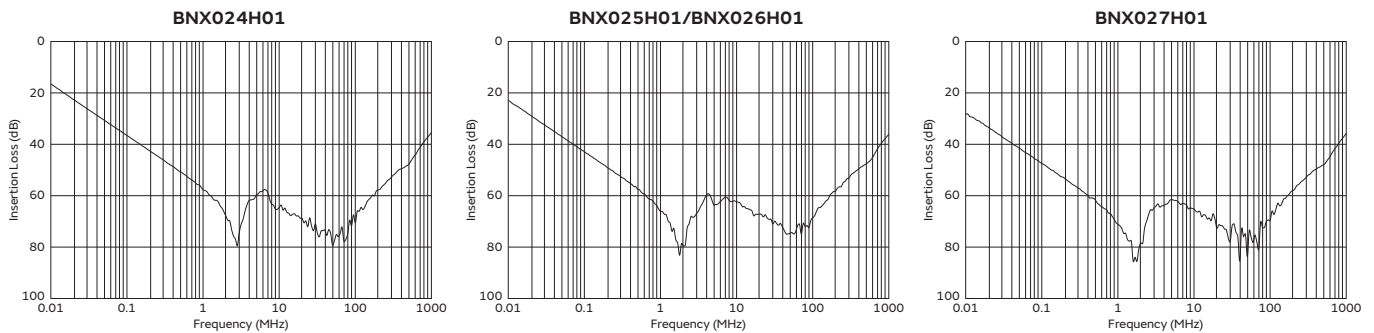

Continued on the following page. ↗

Chip Ferrite Bead  
 SMD Type

Chip EMIFIL®  
 SMD Type

Chip Common Mode Choke Coil  
 SMD Type

Block Type EMIFIL®  
 SMD Type

EMI Suppression Filters  
 Lead Type

Microchip Transformer (Balun)  
 SMD Type

Continued from the preceding page. ↘

## Derating of Rated Current

In operating temperature exceeding +85°C, derating of current is necessary for BNX024H/025H/026H/027H series. Please apply the derating curve shown in chart according to the operating temperature.

Derating of Rated Current

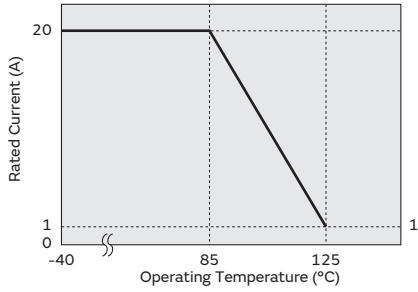

SMD Type  
Chip Ferrite Bead

SMD Type  
Chip EMIFIL®

SMD Type  
Chip Common Mode Choke Coil

SMD Type  
Block Type EMIFIL®

Lead Type  
EMI Suppression Filters

SMD Type  
Microchip Transformer (Balun)

## Block Type EMIFIL<sup>®</sup> SMD Type (BNX Series) ⚠️Caution/Notice

### ⚠️Caution

#### Rating

Do not use products beyond the rated current and rated voltage as this may create excessive heat and deteriorate the insulation resistance.

#### Fail-safe

Be sure to provide an appropriate fail-safe function on your product to prevent a second damage that may be caused by the abnormal function or the failure of our product.

#### ESD

ESD to this product, exceeding condition of IEC61000-4-2 with 30kV, may cause short circuit and fuming or firing.

### Notice

#### Storage and Operating Conditions

##### <Operating Environment>

Do not use products in a chemical atmosphere such as chlorine gas, acid or sulfide gas.

Do not use products in the environment close to the organic solvent.

##### <Storage and Handling Requirements>

##### 1. Storage Period

BNX series should be used within 12 months.

Solderability should be checked if this period is exceeded.

##### 2. Storage Conditions

(1) Storage temperature: -10 to +40°C

Relative humidity: 15 to 85%

Avoid sudden changes in temperature and humidity.

(2) Do not store products in a chemical atmosphere such as chlorine gas, acid or sulfide gas.

#### Notice (Soldering and Mounting)

##### 1. Cleaning

Do not clean BNX series (SMD Type).

##### 2. Soldering

Reliability decreases with improper soldering methods.

Please solder by the standard soldering conditions shown in mounting information.

##### 3. Other

Noise suppression levels resulting from Murata's EMI

suppression filters EMIFIL<sup>®</sup> may vary, depending on the circuits and ICs used, type of noise, mounting pattern, mounting location, and other operating conditions. Be sure to check and confirm in advance the noise suppression effect of each filter, in actual circuits, etc. before applying the filter in a commercial-purpose equipment design.

#### Handling

##### 1. Resin Coating

Using resin for coating/molding products may affect the products performance.

So please pay careful attention in selecting resin.

Prior to use, please make the reliability evaluation with the product mounted in your application set.

##### 2. Handling of a Substrate (for BNX02□)

After mounting products on a substrate, do not apply any stress to the product caused by bending or twisting to

the substrate when cropping the substrate, inserting and removing a connector from the substrate or tightening screw to the substrate.

Excessive mechanical stress may cause cracking in the Product.

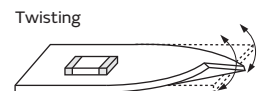
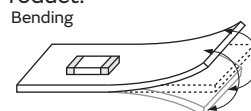

# Block Type EMIFIL<sup>®</sup> SMD Type (BNX Series) Soldering and Mounting

## 1. Standard Land Pattern Dimensions

- Land Pattern + Solder Resist
  - Land Pattern
  - Solder Resist
  - Through Hole
- (in mm)

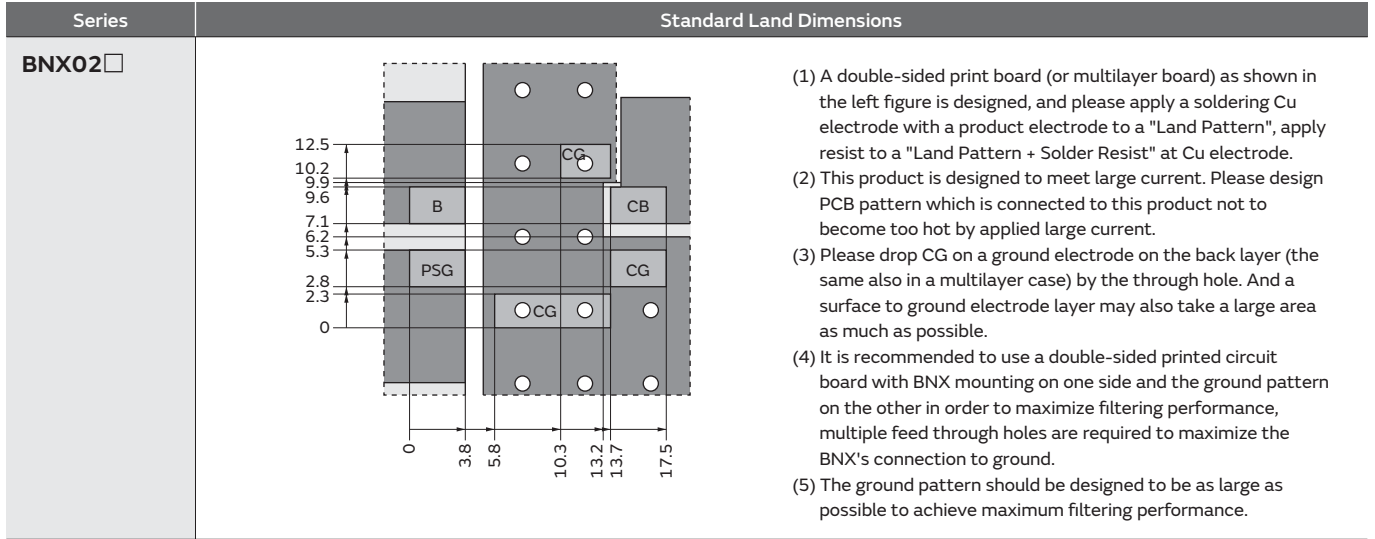

### ● PCB Warping (for BNX02□)

PCB should be designed so that products are not subjected to the mechanical stress caused by warping the board.

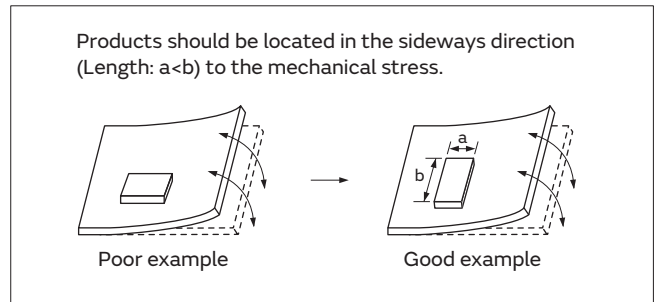

## 2. Solder Paste Printing and Adhesive Application

When reflow soldering the block type EMIFIL<sup>®</sup>, the printing must be conducted in accordance with the following cream solder printing conditions.

If too much solder is applied, the chip will be prone to damage by mechanical and thermal stress from the PCB and may crack.

Standard land dimensions should be used for resist and copper foil patterns.

Series	Solder Paste Printing	Adhesive Application
BNX02□	<p>●Guideline of solder paste thickness: 150-200μm</p>	

Continued on the following page. ↗

SMD Type  
Chip Ferrite Bead

SMD Type  
Chip EMIFIL<sup>®</sup>

SMD Type  
Chip Common Mode Choke Coil

SMD Type  
Block Type EMIFIL<sup>®</sup>

Lead Type  
EMI Suppression Filters

SMD Type  
Microchip Transformer (Balun)

## Block Type EMIFIL<sup>®</sup> SMD Type (BNX Series) Soldering and Mounting

Continued from the preceding page. ↘

### 3. Standard Soldering Conditions

#### (1) Soldering Methods

- Use reflow soldering methods only.
- Use standard soldering conditions when soldering block type EMIFIL<sup>®</sup> SMD type.
- In cases where several different parts are soldered, each having different soldering conditions, use those conditions requiring the least heat and minimum time.

Solder: Use Sn-3.0Ag-0.5Cu solder. Use of Sn-Zn based solder will deteriorate performance of products.

#### Flux:

- Use Rosin-based flux.  
 In case of using RA type solder, products should be cleaned completely with no residual flux.
- Do not use strong acidic flux (with chlorine content exceeding 0.20wt%)
- Do not use water-soluble flux.

For additional mounting methods, please contact Murata.

#### (2) Soldering Profile

- Reflow Soldering Profile (Sn-3.0Ag-0.5Cu solder)

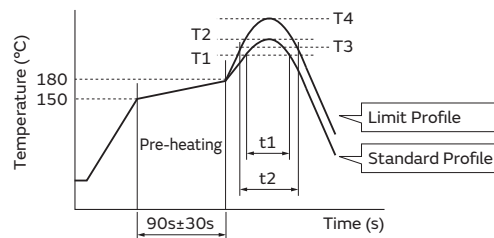

Series	Standard Profile				Limit Profile			
	Heating		Peak Temperature (T2)	Cycle of Reflow	Heating		Peak Temperature (T4)	Cycle of Reflow
	Temp. (T1)	Time. (t1)			Temp. (T3)	Time. (t2)		
BNX02□	220°C min.	30 to 60s	250±3°C	2 times max.	230°C min.	60s max.	260°C/10s	2 times max.

#### (3) Reworking with Solder Iron

- The following conditions must be strictly followed when using a soldering iron.
- Pre-heating: 150°C 60s min.
- Soldering iron power output: 100W max.
- Temperature of soldering iron tip / Soldering time / Times:
- 450°C max. / 5s max. / 2 time

- Do not allow the tip of the soldering iron to directly contact the chip.
- For additional methods of reworking with a soldering iron, please contact Murata engineering.

### 4. Cleaning

Do not clean BNX02□ series, or inner humidity protect material will be damaged, results product's insulation resistance getting worse.

Chip Ferrite Bead SMD Type  
 Chip EMIFIL<sup>®</sup> SMD Type  
 Chip Common Mode Choke Coil SMD Type  
 Block Type EMIFIL<sup>®</sup> SMD Type  
 EMI Suppression Filters Lead Type  
 Microchip Transformer (Balun) SMD Type

## Block Type EMIFIL<sup>®</sup> SMD Type (BNX Series) Packaging

### Minimum Quantity and Dimensions of 24mm Width Embossed Tape

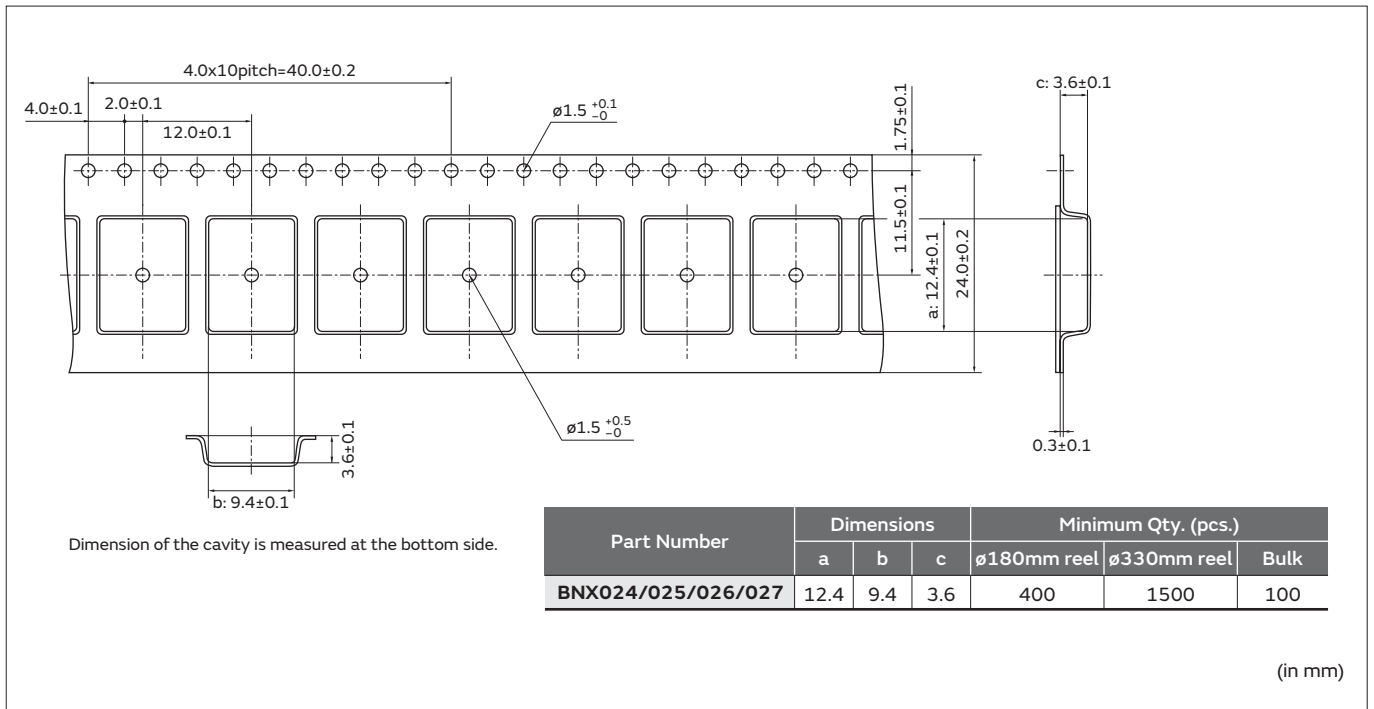

"Minimum Quantity" means the number of units of each delivery or order. The quantity should be an integral multiple of the "Minimum Quantity."

SMD Type  
 Chip Ferrite Bead

SMD Type  
 Chip EMIFIL<sup>®</sup>

SMD Type  
 Chip Common Mode Choke Coil

SMD Type  
 Block Type EMIFIL<sup>®</sup>

Lead Type  
 EMI Suppression Filters

SMD Type  
 Microchip Transformer (Balun)

● Part Numbering

Leaded Multilayer Ferrite Beads for Automotive

(Part Number) 

BL	L	18	AG	121	DB	E1	H	01	A
①	②	③	④	⑤	⑥	⑦	⑧	⑨	⑩

① Product ID

Product ID	
BL	Ferrite Beads

② Type

Code	Type
L	Lead Type

③ Built-in Chip Dimensions

Code	Dimensions (LxW)	Size Code (inch)
18	1.6x0.8mm	0603

④ Characteristics/Applications

Code	Characteristics/Applications
AG	For General Signal

⑤ Impedance

Typical impedance at 100MHz is expressed by three figures.  
 The unit is in ohm (Ω).  
 The first and second figures are significant digits, and the third figure expresses the number of zeros that follow the two figures.

⑥ Lead Type/⑩ Packaging

Code		Lead Type	Lead Length* (mm)	Packaging
⑥	⑩			
A2	B	Straight	28.0±1.0	Bulk
DB	A		20.0±1.0	Ammo Pack

\*Lead distance between reference and bottom planes except for Bulk.

⑦ Category

Code	Category
E1	Expressed by a letter and numbers

⑧ Features

Code	Circuit	
H	For Automotive	Powertrain, Safety

⑨ Individual Specification Code

Code	Lead Material
01	CP Line
02	Cu Line

Chip Ferrite Bead  
SMD Type

Chip EMIFIL®  
SMD Type

Chip Common Mode Choke Coil  
SMD Type

Block Type EMIFIL®  
SMD Type

EMI Suppression Filters  
Lead Type

Microchip Transformer (Balun)  
SMD Type



### Disc Type EMIFIL® for Automotive

(Part Number) 

DS	S	1	Z	B3	2A	220	Q55	B
①	②	③	④	⑤	⑥	⑦	⑧	⑨

#### ① Product ID

Product ID	
<b>DS</b>	Three-terminal Capacitor

#### ② Structure

Code	Structure
<b>S</b>	Built-in Ferrite Beads Type

#### ③ Style

Code	Style
<b>1</b>	Expressed by a letter.

#### ④ Category

Code	Category	
<b>Z</b>	For Automotive	Infotainment

#### ⑥ Lead Type/⑨ Packaging

Code	Lead Type	Lead Length* (mm)	Packaging	Series
<b>Q55B</b>	Straight	25.0 min.	Bulk	<b>DSS1</b>
<b>Q91A</b>		20.0±1.0	Ammo Pack	
<b>Q92A</b>		16.5±1.0		
<b>Q93A</b>		18.5±1.0		

\*Lead Distance between Reference and Bottom Planes Except for Bulk.

#### ⑤ Temperature Characteristics

Code	Capacitance Change
<b>B3</b>	±10% (Temperature Range: -25°C to +85°C)

#### ⑥ Rated Voltage

Code	Rated Voltage
<b>1H</b>	50V
<b>2A</b>	100V

#### ⑦ Capacitance

Expressed by three alphanumeric. The unit is in pico-farad (pF). The first and second figures are significant digits, and the third figure expresses the number of zeros that follow the two figures.

## EMIGUARD® (EMIFIL® with Varistor Function) for Automotive

(Part Number) 

VF	C	2	H	R7	1D	105	K	2	M1	A
①	②	③	④	⑤	⑥	⑦	⑧	⑨	⑩	⑪

### ① Product ID

Product ID	
VF	EMIGUARD® Lead Type

### ② Structure

Code	Structure
C	Built-in Capacitor

### ③ Style

Code	Style
2	Size is expressed by a digit

### ④ Features

Code	Features	
H	For Automotive	Powertrain, Safety

### ⑤ Temperature Characteristics

Code	Capacitance Change
R7	±15% (-55°C to +125°C)

### ⑩ Lead Type/⑪ Packaging

Code	Lead Type	Lead Length*	Packaging	Series
M1A	Inside Crimp	18.0±1.0mm	Ammo Pack	VFC2

\*From bottom of the crimp.

### ⑥ Rated Voltage

Code	Rated Voltage
1D	22V

### ⑦ Capacitance

Expressed by three alphanumerics. The unit is in pico-farad (pF). The first and second figures are significant digits, and the third figure expresses the number of zeros that follow the two figures.

### ⑧ Capacitance Tolerance

Code	Capacitance Tolerance
K	±10%

### ⑨ Varistor Voltage

Code	Varistor Voltage
2	27V

Chip Ferrite Bead  
SMD Type

Chip EMIFIL®  
SMD Type

Chip Common Mode Choke Coil  
SMD Type

Block Type EMIFIL®  
SMD Type

EMI Suppression Filters  
Lead Type

Microchip Transformer (Balun)  
SMD Type

# Leaded Multilayer Ferrite Beads Lead Type

## BLL18AG Series

### Appearance/Dimensions

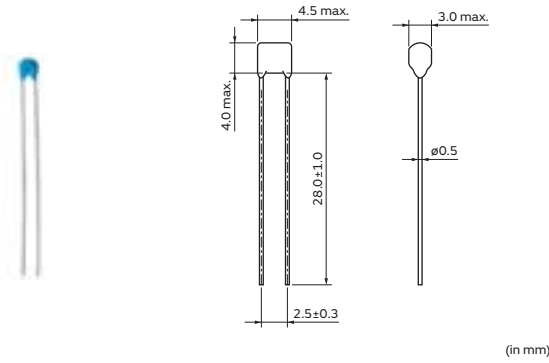

### Packaging

Code	Packaging	Minimum Quantity
B	Packing in Bulk	500
A	Ammo Pack	2000

### Equivalent Circuit



(Resistance element becomes dominant at high frequencies.)

### Rated Value (□: packaging code)

Part Number		Impedance (at 100MHz/20°C)	Rated Current	DC Resistance	Operating Temperature Range
For Infotainment	For Powertrain/Safety				
—	BLL18AG121A2E1H01B	120Ω±40%	200mA	0.5Ω max.	-40°C to +150°C
—	BLL18AG121DBE1H01A	120Ω±40%	200mA	0.5Ω max.	-40°C to +150°C
—	BLL18AG151A2E1H01B	150Ω±40%	200mA	0.55Ω max.	-40°C to +150°C
—	BLL18AG151DBE1H01A	150Ω±40%	200mA	0.55Ω max.	-40°C to +150°C
—	BLL18AG221A2E1H01B	220Ω±40%	200mA	0.55Ω max.	-40°C to +150°C
—	BLL18AG221DBE1H01A	220Ω±40%	200mA	0.55Ω max.	-40°C to +150°C
—	BLL18AG331A2E1H01B	330Ω±40%	200mA	0.6Ω max.	-40°C to +150°C
—	BLL18AG331DBE1H01A	330Ω±40%	200mA	0.6Ω max.	-40°C to +150°C
—	BLL18AG471A2E1H01B	470Ω±40%	200mA	0.65Ω max.	-40°C to +150°C
—	BLL18AG471DBE1H01A	470Ω±40%	200mA	0.65Ω max.	-40°C to +150°C
—	BLL18AG601A2E1H01B	600Ω±40%	200mA	0.7Ω max.	-40°C to +150°C
—	BLL18AG601DBE1H01A	600Ω±40%	200mA	0.7Ω max.	-40°C to +150°C
—	BLL18AG102A2E1H01B	1000Ω±40%	200mA	0.8Ω max.	-40°C to +150°C
—	BLL18AG102DBE1H01A	1000Ω±40%	200mA	0.8Ω max.	-40°C to +150°C

Number of Circuits: 1

### Impedance-Frequency Characteristics (Main Items)

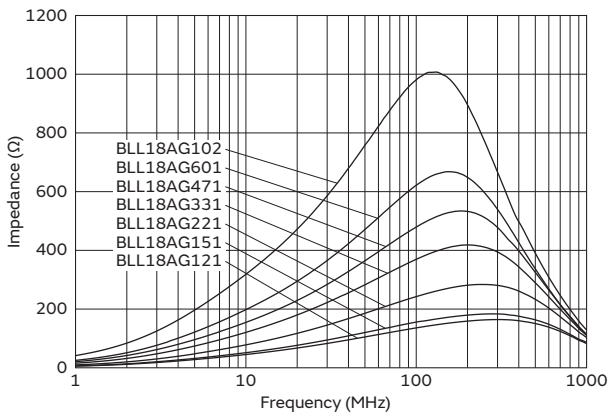

Continued on the following page. ↗

Continued from the preceding page. ↘

## Impedance-Frequency Characteristics

**BLL18AG121A2E1H01/BLL18AG121DBE1H01**

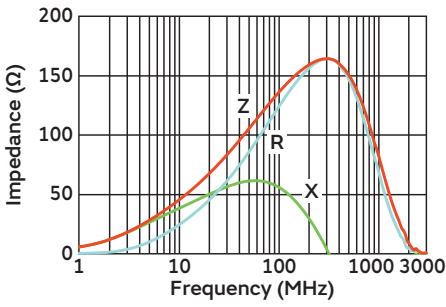

**BLL18AG151A2E1H01/BLL18AG151DBE1H01**

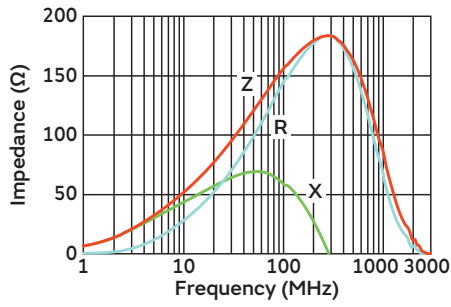

**BLL18AG221A2E1H01/BLL18AG221DBE1H01**

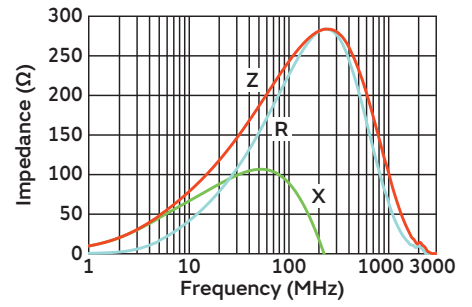

**BLL18AG331A2E1H01/BLL18AG331DBE1H01**

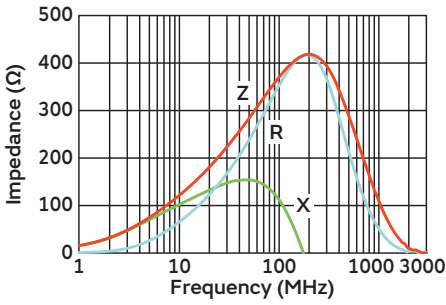

**BLL18AG471A2E1H01/BLL18AG471DBE1H01**

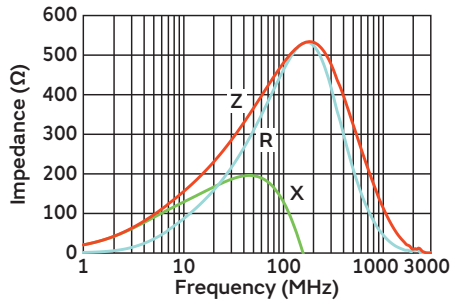

**BLL18AG601A2E1H01/BLL18AG601DBE1H01**

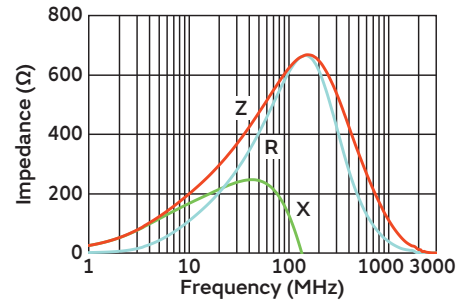

**BLL18AG102A2E1H01/BLL18AG102DBE1H01**

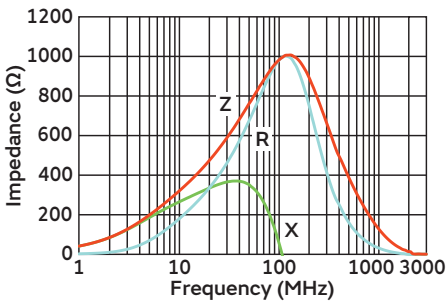

Chip Ferrite Bead  
SMD Type

Chip EMIFIL®  
SMD Type

Chip Common Mode Choke Coil  
SMD Type

Block Type EMIFIL®  
SMD Type

EMI Suppression Filters  
Lead Type

Microchip Transformer (Balun)  
SMD Type

# EMIFIL® Lead Type DSS1 Series

## Appearance/Dimensions

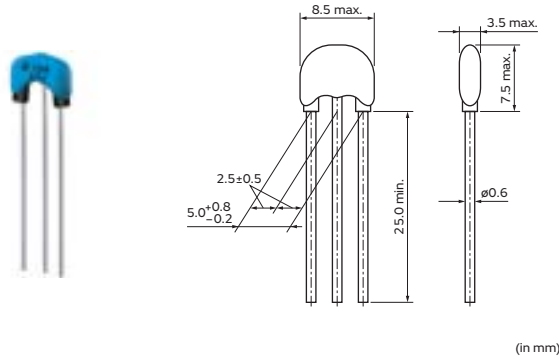

## Packaging

Code	Packaging	Minimum Quantity
B	Packing in Bulk	250
A	Ammo Pack	1500

## Equivalent Circuit

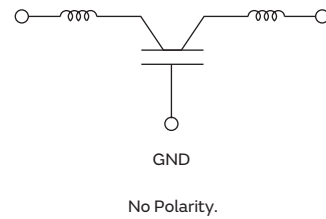

## Rated Value (□: packaging code)

Part Number		Capacitance	Rated Current	Rated Voltage	Operating Temperature Range
For Infotainment	For Powertrain/Safety				
DSS1ZB32A220Q55B	—	22pF±10%	6A	100Vdc	-40°C to +85°C
DSS1ZB32A220Q91A	—	22pF±10%	6A	100Vdc	-40°C to +85°C
DSS1ZB32A220Q92A	—	22pF±10%	6A	100Vdc	-40°C to +85°C
DSS1ZB32A220Q93A	—	22pF±10%	6A	100Vdc	-40°C to +85°C
DSS1ZB32A330Q55B	—	33pF±10%	6A	100Vdc	-40°C to +85°C
DSS1ZB32A330Q91A	—	33pF±10%	6A	100Vdc	-40°C to +85°C
DSS1ZB32A330Q92A	—	33pF±10%	6A	100Vdc	-40°C to +85°C
DSS1ZB32A330Q93A	—	33pF±10%	6A	100Vdc	-40°C to +85°C
DSS1ZB32A470Q55B	—	47pF±10%	6A	100Vdc	-40°C to +85°C
DSS1ZB32A470Q91A	—	47pF±10%	6A	100Vdc	-40°C to +85°C
DSS1ZB32A470Q92A	—	47pF±10%	6A	100Vdc	-40°C to +85°C
DSS1ZB32A470Q93A	—	47pF±10%	6A	100Vdc	-40°C to +85°C
DSS1ZB32A680Q55B	—	68pF±10%	6A	100Vdc	-40°C to +85°C
DSS1ZB32A680Q91A	—	68pF±10%	6A	100Vdc	-40°C to +85°C
DSS1ZB32A680Q92A	—	68pF±10%	6A	100Vdc	-40°C to +85°C
DSS1ZB32A680Q93A	—	68pF±10%	6A	100Vdc	-40°C to +85°C
DSS1ZB32A101Q55B	—	100pF±10%	6A	100Vdc	-40°C to +85°C
DSS1ZB32A101Q91A	—	100pF±10%	6A	100Vdc	-40°C to +85°C
DSS1ZB32A101Q92A	—	100pF±10%	6A	100Vdc	-40°C to +85°C
DSS1ZB32A101Q93A	—	100pF±10%	6A	100Vdc	-40°C to +85°C
DSS1ZB32A121Q55B	—	120pF±10%	6A	100Vdc	-40°C to +85°C
DSS1ZB32A121Q91A	—	120pF±10%	6A	100Vdc	-40°C to +85°C
DSS1ZB32A121Q92A	—	120pF±10%	6A	100Vdc	-40°C to +85°C
DSS1ZB32A121Q93A	—	120pF±10%	6A	100Vdc	-40°C to +85°C
DSS1ZB32A151Q55B	—	150pF±10%	6A	100Vdc	-40°C to +85°C
DSS1ZB32A151Q91A	—	150pF±10%	6A	100Vdc	-40°C to +85°C
DSS1ZB32A151Q92A	—	150pF±10%	6A	100Vdc	-40°C to +85°C
DSS1ZB32A151Q93A	—	150pF±10%	6A	100Vdc	-40°C to +85°C
DSS1ZB32A221Q55B	—	220pF±10%	6A	100Vdc	-40°C to +85°C
DSS1ZB32A221Q91A	—	220pF±10%	6A	100Vdc	-40°C to +85°C
DSS1ZB32A221Q92A	—	220pF±10%	6A	100Vdc	-40°C to +85°C
DSS1ZB32A221Q93A	—	220pF±10%	6A	100Vdc	-40°C to +85°C

Number of Circuit: 1

Continued on the following page. ↗

SMD Type  
 Chip Ferrite Bead

SMD Type  
 Chip EMIFIL®

SMD Type  
 Chip Common Mode Choke Coil

SMD Type  
 Block Type EMIFIL®

Lead Type  
 EMI Suppression Filters

SMD Type  
 Microchip Transformer (Balun)

Continued from the preceding page. ↘

Part Number		Capacitance	Rated Current	Rated Voltage	Operating Temperature Range
For Infotainment	For Powertrain/Safety				
DSS1ZB32A271Q55B	—	270pF±10%	6A	100Vdc	-40°C to +85°C
DSS1ZB32A271Q91A	—	270pF±10%	6A	100Vdc	-40°C to +85°C
DSS1ZB32A271Q92A	—	270pF±10%	6A	100Vdc	-40°C to +85°C
DSS1ZB32A271Q93A	—	270pF±10%	6A	100Vdc	-40°C to +85°C
DSS1ZB32A331Q55B	—	330pF±10%	6A	100Vdc	-40°C to +85°C
DSS1ZB32A331Q91A	—	330pF±10%	6A	100Vdc	-40°C to +85°C
DSS1ZB32A331Q92A	—	330pF±10%	6A	100Vdc	-40°C to +85°C
DSS1ZB32A331Q93A	—	330pF±10%	6A	100Vdc	-40°C to +85°C
DSS1ZB32A471Q55B	—	470pF±10%	6A	100Vdc	-40°C to +85°C
DSS1ZB32A471Q91A	—	470pF±10%	6A	100Vdc	-40°C to +85°C
DSS1ZB32A471Q92A	—	470pF±10%	6A	100Vdc	-40°C to +85°C
DSS1ZB32A471Q93A	—	470pF±10%	6A	100Vdc	-40°C to +85°C
DSS1ZB32A681Q55B	—	680pF±10%	6A	100Vdc	-40°C to +85°C
DSS1ZB32A681Q91A	—	680pF±10%	6A	100Vdc	-40°C to +85°C
DSS1ZB32A681Q92A	—	680pF±10%	6A	100Vdc	-40°C to +85°C
DSS1ZB32A681Q93A	—	680pF±10%	6A	100Vdc	-40°C to +85°C
DSS1ZB32A102Q55B	—	1000pF±10%	6A	100Vdc	-40°C to +85°C
DSS1ZB32A102Q91A	—	1000pF±10%	6A	100Vdc	-40°C to +85°C
DSS1ZB32A102Q92A	—	1000pF±10%	6A	100Vdc	-40°C to +85°C
DSS1ZB32A102Q93A	—	1000pF±10%	6A	100Vdc	-40°C to +85°C
DSS1ZB32A152Q55B	—	1500pF±10%	6A	100Vdc	-40°C to +85°C
DSS1ZB32A152Q91A	—	1500pF±10%	6A	100Vdc	-40°C to +85°C
DSS1ZB32A152Q92A	—	1500pF±10%	6A	100Vdc	-40°C to +85°C
DSS1ZB32A152Q93A	—	1500pF±10%	6A	100Vdc	-40°C to +85°C
DSS1ZB32A222Q55B	—	2200pF±10%	6A	100Vdc	-40°C to +85°C
DSS1ZB32A222Q91A	—	2200pF±10%	6A	100Vdc	-40°C to +85°C
DSS1ZB32A222Q92A	—	2200pF±10%	6A	100Vdc	-40°C to +85°C
DSS1ZB32A222Q93A	—	2200pF±10%	6A	100Vdc	-40°C to +85°C
DSS1ZB32A332Q55B	—	3300pF±10%	6A	100Vdc	-40°C to +85°C
DSS1ZB32A332Q91A	—	3300pF±10%	6A	100Vdc	-40°C to +85°C
DSS1ZB32A332Q92A	—	3300pF±10%	6A	100Vdc	-40°C to +85°C
DSS1ZB32A332Q93A	—	3300pF±10%	6A	100Vdc	-40°C to +85°C
DSS1ZB32A472Q55B	—	4700pF±10%	6A	100Vdc	-40°C to +85°C
DSS1ZB32A472Q91A	—	4700pF±10%	6A	100Vdc	-40°C to +85°C
DSS1ZB32A472Q92A	—	4700pF±10%	6A	100Vdc	-40°C to +85°C
DSS1ZB32A472Q93A	—	4700pF±10%	6A	100Vdc	-40°C to +85°C
DSS1ZB32A682Q55B	—	6800pF±10%	6A	100Vdc	-40°C to +85°C
DSS1ZB32A682Q91A	—	6800pF±10%	6A	100Vdc	-40°C to +85°C
DSS1ZB32A682Q92A	—	6800pF±10%	6A	100Vdc	-40°C to +85°C
DSS1ZB32A682Q93A	—	6800pF±10%	6A	100Vdc	-40°C to +85°C
DSS1ZB32A103Q55B	—	10000pF±10%	6A	100Vdc	-40°C to +85°C
DSS1ZB32A103Q91A	—	10000pF±10%	6A	100Vdc	-40°C to +85°C
DSS1ZB32A103Q92A	—	10000pF±10%	6A	100Vdc	-40°C to +85°C
DSS1ZB32A103Q93A	—	10000pF±10%	6A	100Vdc	-40°C to +85°C
DSS1ZB32A153Q55B	—	15000pF±10%	6A	100Vdc	-40°C to +85°C
DSS1ZB32A153Q91A	—	15000pF±10%	6A	100Vdc	-40°C to +85°C
DSS1ZB32A153Q92A	—	15000pF±10%	6A	100Vdc	-40°C to +85°C
DSS1ZB32A153Q93A	—	15000pF±10%	6A	100Vdc	-40°C to +85°C
DSS1ZB32A223Q55B	—	22000pF±10%	6A	100Vdc	-40°C to +85°C
DSS1ZB32A223Q91A	—	22000pF±10%	6A	100Vdc	-40°C to +85°C
DSS1ZB32A223Q92A	—	22000pF±10%	6A	100Vdc	-40°C to +85°C
DSS1ZB32A223Q93A	—	22000pF±10%	6A	100Vdc	-40°C to +85°C
DSS1ZB31H333Q55B	—	33000pF±10%	6A	50Vdc	-40°C to +85°C

Number of Circuit: 1

Continued on the following page. ↗

Continued from the preceding page. ↘

Part Number		Capacitance	Rated Current	Rated Voltage	Operating Temperature Range
For Infotainment	For Powertrain/Safety				
DSS1ZB31H333Q91A	—	33000pF±10%	6A	50Vdc	-40°C to +85°C
DSS1ZB31H333Q92A	—	33000pF±10%	6A	50Vdc	-40°C to +85°C
DSS1ZB31H333Q93A	—	33000pF±10%	6A	50Vdc	-40°C to +85°C
DSS1ZB31H473Q55B	—	47000pF±10%	6A	50Vdc	-40°C to +85°C
DSS1ZB31H473Q91A	—	47000pF±10%	6A	50Vdc	-40°C to +85°C
DSS1ZB31H473Q92A	—	47000pF±10%	6A	50Vdc	-40°C to +85°C
DSS1ZB31H473Q93A	—	47000pF±10%	6A	50Vdc	-40°C to +85°C
DSS1ZB31H104Q55B	—	100000pF±10%	6A	50Vdc	-40°C to +85°C
DSS1ZB31H104Q91A	—	100000pF±10%	6A	50Vdc	-40°C to +85°C
DSS1ZB31H104Q92A	—	100000pF±10%	6A	50Vdc	-40°C to +85°C
DSS1ZB31H104Q93A	—	100000pF±10%	6A	50Vdc	-40°C to +85°C

Number of Circuit: 1

### Insertion Loss Characteristics (Main Items)

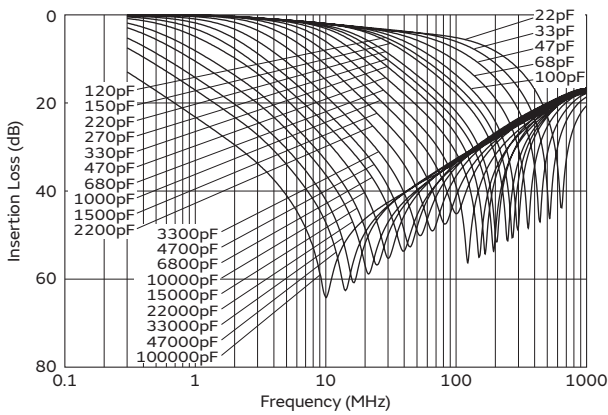

SMD Type  
 Chip Ferrite Bead

SMD Type  
 Chip EMIFIL®

SMD Type  
 Chip Common Mode Choke Coil

SMD Type  
 Block Type EMIFIL®

Lead Type  
 EMI Suppression Filters

SMD Type  
 Microchip Transformer (Balun)

# EMIGUARD® (EMIFIL® with Varistor Function) Lead Type VFC2 Series

## Appearance/Dimensions

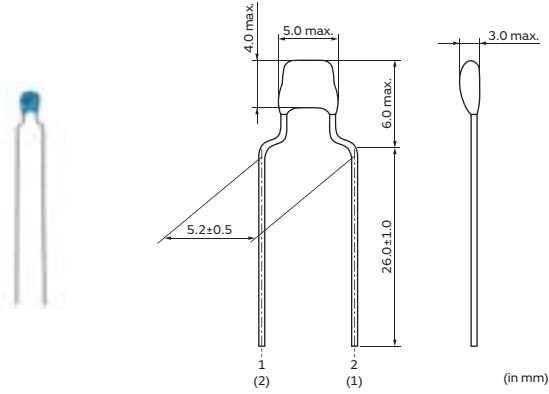

## Packaging

Code	Packaging	Minimum Quantity
A	Ammo Pack	2000

## Equivalent Circuit

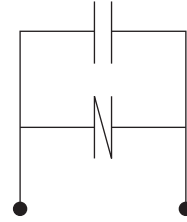

## Rated Value (□: packaging code)

Part Number		Varistor Voltage	Capacitance	Temperature Characteristics	Rated Voltage	Insulation Resistance (min.)
For Infotainment	For Powertrain/Safety					
—	VFC2HR71D105K2M1□	27Vdc +5/-3V	1.0μF ±10%	R7 (±15%)	22Vdc	1MΩ

Operating Temperature Range: -55°C to +125°C

Chip Ferrite Bead  
SMD Type

Chip EMIFIL®  
SMD Type

Chip Common Mode Choke Coil  
SMD Type

Block Type EMIFIL®  
SMD Type

EMI Suppression Filters  
Lead Type

Microchip Transformer (Balun)  
SMD Type



# Block Type EMIFIL® Lead Type BNX012 Series

## Appearance/Dimensions

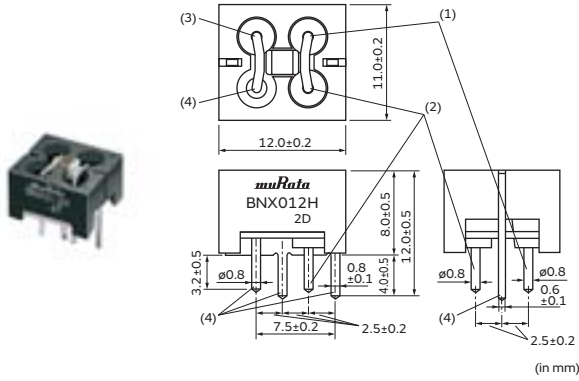

## Packaging

Code	Packaging	Minimum Quantity
-	Box	150

## Equivalent Circuit

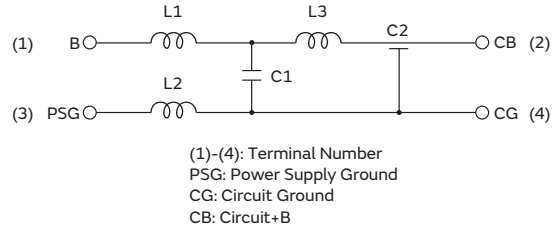

## Rated Value (□: packaging code)

Part Number		Rated Voltage	Withstand Voltage	Rated Current	Insulation Resistance (min.)	Insertion Loss
For Infotainment	For Powertrain/Safety					
—	<b>BNX012H01</b>	50Vdc	125Vdc	15A	500MΩ	1MHz to 1GHz:40dB min. (Line impedance=50Ω)

Operating Temperature Range: -55°C to +125°C  
 In operating temperatures exceeding +85°C, derating of current is necessary.

## Insertion Loss Characteristics (Main Items)

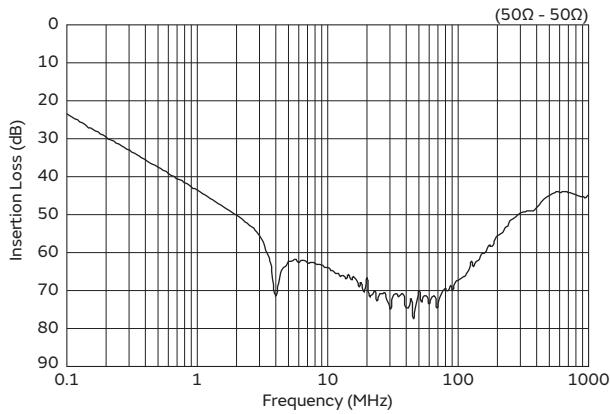

Continued on the following page. ↗

Continued from the preceding page. ↘

## Derating of Rated current

### ● Rating

In operating temperatures exceeding +85°C, derating of current is necessary for BNX012H series. Please apply the derating curve shown in chart according to the operating temperature.

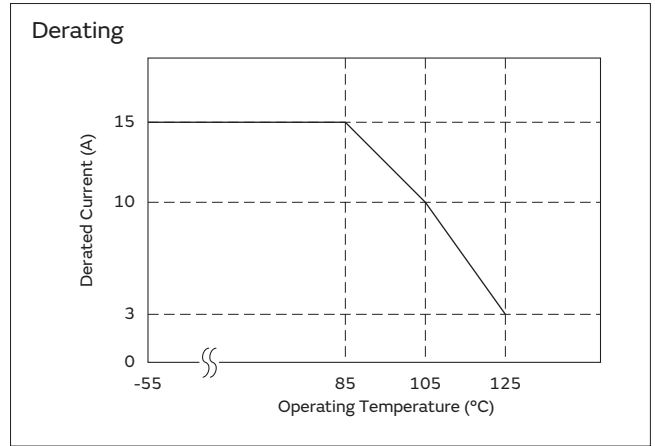

### ● Connecting ± Power Line

In case of using ± power line, please connect to each terminal as shown.

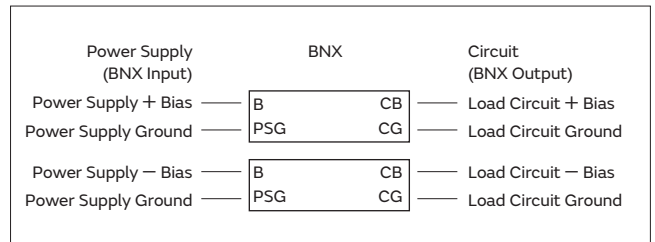

Chip Ferrite Bead  
SMD Type

Chip EMIFIL®  
SMD Type

Chip Common Mode Choke Coil  
SMD Type

Block Type EMIFIL®  
SMD Type

EMI Suppression Filters  
Lead Type

Microchip Transformer (Balun)  
SMD Type

## Leaded Multilayer Ferrite Beads (BLL□ Series) ⚠️Caution/Notice

### ⚠️Caution

#### Rating

Do not use products beyond the rated current as this may create excessive heat and deteriorate the insulation resistance.

#### Soldering and Mounting

##### 1. Bonding, resin molding and coating

In case of bonding, molding or coating this product, verify that these processes do not affect the quality of the capacitor by testing the performance of the bonded, molded or coated product in the intended equipment. In case the amount of application, dryness / hardening conditions of adhesives and molding resins containing organic solvents (ethyl acetate, methyl ethyl ketone, toluene, etc.) are unsuitable, the outer coating resin of a capacitor may be damaged by the organic solvents and may result, worst case, in a short circuit. The variation in thickness of adhesive or molding resin or coating may cause an outer coating resins cracking and / or ceramic element cracking of this product in a temperature cycling.

##### 2. Treatment after bonding, resin molding and coating

When the outer coating is hot (over 100 degrees centigrade) after soldering, it becomes soft and fragile, so please be careful not to give it mechanical stress.

##### 3. Mounting holes

Mounting holes should be designed as specified in this specifications.

Or different design from this specifications may cause cracks in ceramics which may lead to smoking / firing.

##### 4. Caution for the product angle adjust work

Take care not to apply any mechanical stress to product body at the lead terminal bending process for product angle adjustment after insertion.

### Notice

#### Storage and Operating Condition

##### 1. Operating Environment

- (1) Do not use products in corrosive gases such as chlorine gas, acid or sulfide gas.
- (2) Do not use products in the environment where water, oil or organic solvents may adhere to products.
- (3) Do not adhere any resin to products, coat nor mold products with any resin (including adhesive) to prevent mechanical and chemical stress on products.

##### 2. Storage period

Use the products within 12 months after delivered. Solderability should be checked if this period is exceeded.

##### 3. Storage Conditions

- (1) Storage temperature: -10 to +40 degree C  
Relative humidity: 15 to 85%  
Avoid sudden changes in temperature and humidity.
- (2) Do not store products in a chemical atmosphere such as chlorine gas, acid or sulfide gas.

#### Soldering and Mounting

##### 1. Washing

Failure and degradation of a product are caused by the washing method. When you wash in conditions that are not in the mounting information, please contact Murata engineering.

##### 2. Soldering

Reliability decreases with improper soldering methods. Please solder by the standard soldering conditions shown in the mounting information.

## EMIFIL<sup>®</sup> Lead Type (DS□/VF□ Series) ⚠️Caution/Notice

### ⚠️Caution

#### Rating

1. Do not use products beyond the rated current and rated voltage as this may create excessive heat and deteriorate the insulation resistance.
2. Products should not be applied for the absorption of surge which have large energy (ex. Included lighting surge, switching surges) because it is designed for the absorption of electrostatic surges, or it results cracks in ceramics which may lead to smoking / firing.

#### Soldering and Mounting

1. Mounting holes should be designed as specified in these specifications. Other designs than those shown in these specifications may cause cracks in ceramics that may lead to smoking or firing.
2. Take care not to apply any mechanical stress to product body at the lead terminal bending process for product angle adjustment after insertion.

### Notice

#### Storage and Operating Conditions

##### <Operating Environment>

1. Do not use products in a chemical atmosphere such as chlorine gas, acid or sulfide gas.
2. Do not use products near water, oil or organic solvents. Avoid environments where dust or dirt may adhere to the product.
3. Do not adhere any resin to products, coat nor mold products with any resin (including adhesive) to prevent mechanical and chemical stress on products.

##### <Storage and Handling Requirements>

1. Storage Period  
Use the products within 12 months after delivery.  
Solderability should be checked if this period is exceeded.

##### 2. Storage Conditions

- (1) Storage temperature: -10 to 40 degrees C  
Relative humidity: 15 to 85%  
Avoid sudden changes in temperature and humidity.
- (2) Do not store products in a chemical atmosphere such as chlorine gas, acid or sulfide gas.

##### <Using EMIGUARD<sup>®</sup> effectively>

1. Products should be used at rated voltage or less and rated current or less.

#### Soldering and Mounting

##### 1. Washing

Failure and degradation of a product are caused by the washing method. When you wash in conditions that are not in the mounting information, please contact Murata engineering.

##### 2. Soldering

Reliability decreases with improper soldering methods. Please solder by the standard soldering conditions shown in the mounting information.

##### 3. Other

Noise suppression levels resulting from Murata's EMI suppression filters EMIFIL<sup>®</sup> may vary, depending on the circuits and ICs used, type of noise, mounting pattern, lead wire length, mounting location, and other operating conditions. Be sure to check and confirm in advance the noise suppression effect of each filter, in actual circuits, etc. before applying the filter in a commercial-purpose equipment design.

## Block Type EMIFIL<sup>®</sup> Lead Type (BNX Series) ⚠️Caution/Notice

### ⚠️Caution

#### Rating

Do not use products beyond the rated current and rated voltage as this may create excessive heat and deteriorate the insulation resistance.

#### Fail-safe

Be sure to provide an appropriate fail-safe function on your product to prevent a second damage that may be caused by the abnormal function or the failure of our product.

### Notice

#### Storage and Operating Conditions

##### <Operating Environment>

1. Do not use products in a chemical atmosphere such as chlorine gas, acid or sulfide gas.
2. Do not use products near water, oil or organic solvents.

##### <Storage and Handling Requirements>

##### 1. Storage Period

- BNX Series should be used within 12 months.
- Solderability should be checked if this period is exceeded.

##### 2. Storage Conditions

- (1) Storage temperature: -10 to +40°C  
Relative humidity: 15 to 85%  
Avoid sudden changes in temperature and humidity.
- (2) Do not store products in a chemical atmosphere such as chlorine gas, acid or sulfide gas.

#### Notice (Soldering and Mounting)

##### 1. Cleaning

Failure and degradation of a product are caused by the cleaning method. When you clean in conditions that are not in mounting information, please contact Murata engineering.

##### 2. Soldering

Reliability decreases with improper soldering methods. Please solder by the standard soldering conditions shown in mounting information.

##### 3. Other

Noise suppression levels resulting from Murata's EMI suppression filters "EMIFIL" may vary, depending on the circuits and ICs used, type of noise, mounting pattern, lead wire length, mounting location, and other operating conditions. Be sure to check and confirm in advance the noise suppression effect of each filter, in actual circuits, etc. before applying the filter in a commercial-purpose equipment design.

#### Notice (Appearance)

Although some part of the product surface seems to be white in some cases, do not care because it is the result of waxing process for humidity resistance improvement. This wax does not make bad affection to mechanical or electrical performance, reliability of the product.

## Leaded Multilayer Ferrite Beads (BLL□ Series) Soldering and Mounting

### 1. Mounting Hole

Mounting holes should be designed as specified below.

(in mm)

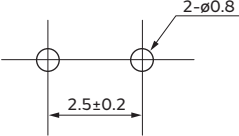
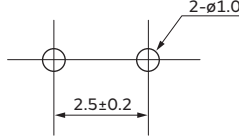
Part Number	Bulk Type	Taping Type
<b>BLL</b>		

### 2. Soldering

- (1) Use Sn-3.0Ag-0.5Cu solder.
- (2) Use Rosin-based flux. Do not use strong acidic flux with halide content exceeding 0.2wt% (chlorine conversion value).
- (3) Products and the leads should not be subjected to any mechanical stress during the soldering process, or while subjected to the equivalent high temperatures.
- (4) Standard flow soldering profile.

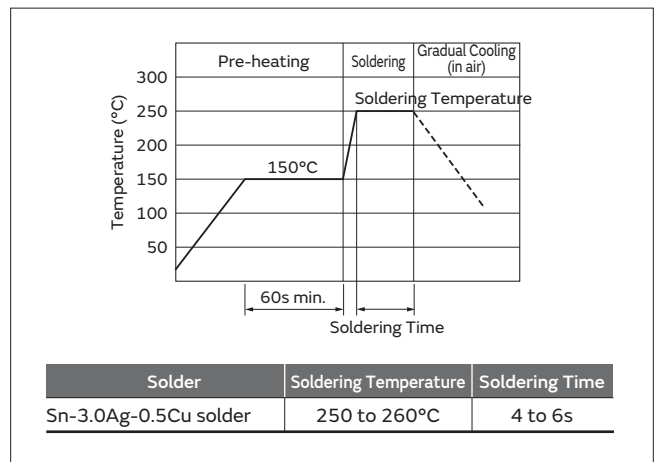

### 3. Cleaning Conditions

- (1) Do not clean after soldering. If cleaning, please contact us.

# EMIFIL® Lead Type (DS□/VF□ Series) Soldering and Mounting

## 1. Mounting Hole

Mounting holes should be designed as specified below.

Part Number	Bulk Type (in mm)	Taping Type (in mm)
DSS1		
VFC2H		

## 2. Soldering

- (1) Use Sn-3.0Ag-0.5Cu solder.
- (2) Use Rosin-based flux. Do not use strong acidic flux with halide content exceeding 0.2wt% (chlorine conversion value).
- (3) Products and the leads should not be subjected to any mechanical stress during the soldering process, or while subjected to the equivalent high temperatures.
- (4) Standard flow soldering profile.

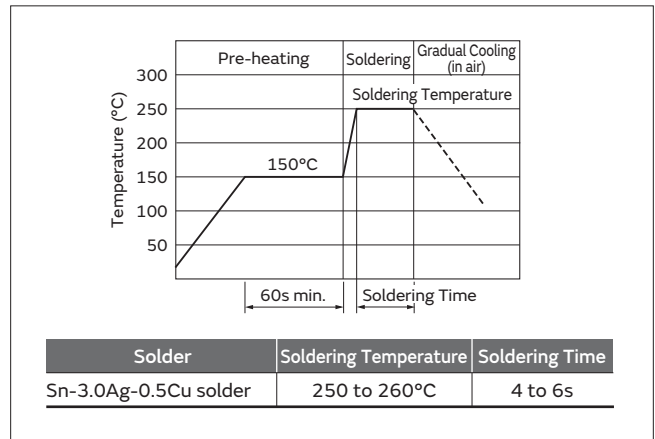

## 3. Cleaning Conditions

Clean other parts in the following conditions.

- (1) Cleaning temperature should be limited to 60°C max. (40°C max for alcohol type cleaner).
- (2) Ultrasonic cleaning should comply with the following conditions, avoiding the resonance phenomenon at the mounted products and PCB.  
 Power: 20 W / l max. Frequency: 28 to 40kHz  
 Time: 5 min. max.
- (3) Cleaner
  - (a) Alcohol type cleaner  
 Isopropyl alcohol (IPA)
  - (b) Aqueous agent (VFC2 series cannot be cleaned)  
 PINE ALPHA ST-100S

- (4) There should be no residual flux or residual cleaner left after cleaning.  
 In the case of using aqueous agent, products should be dried completely after rinsing with de-ionized water in order to remove the cleaner.
- (5) The surface of products may become dirty after cleaning, but there is no deterioration on mechanical, electrical characteristics and reliability.
- (6) Other cleaning: Please contact us.

# Block Type EMIFIL<sup>®</sup> Lead Type (BNX Series) Soldering and Mounting

## 1. Mounting Hole

■ Mounting holes should be designed as specified below.

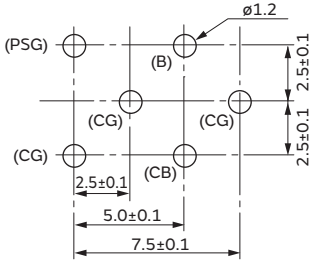
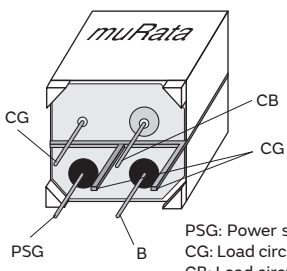
Series	Mounting Hole
BNX01□	<p>Component Side</p>  <p>Terminal Layout (Bottom figure)</p>  <p>PSG: Power supply ground                  CG: Load circuit ground                  CB: Load circuit + Bias</p>

## 2. Using the Block Type EMIFIL<sup>®</sup> (Lead Type) Effectively

### (1) How to use effectively

This product effectively prevents undesired radiation and external noise from going out / entering the circuit by grounding the high frequency components which cause noise problems. Therefore, grounding conditions may affect the performance of the filter and attention should be paid to the following for effective use.

- Design maximized grounding area in the P.C. board, and grounding pattern for all the grounding terminals of the product to be connected. (Please follow the specified recommendations.)
- Minimize the distance between ground of the P.C. board and the ground plate of the product. (Recommend using the through hole connection between grounding area both of component side and bottom side.)
- Insert the terminals into the holes on P.C. board completely.
- Don't connect PSG terminal with CG terminal directly. (See the item 1. Terminal Layout)

### (2) Self-heating

Though this product has a large rated current, localized selfheating may be caused depending on soldering conditions. To avoid this, attention should be paid to the following:

- Use P.C. board with our recommendation on hole diameter / land pattern dimensions, mentioned in the right hand drawing, especially for 4 terminals which pass current.
- Solder the terminals to the P.C. board with soldercover area at least 90%. Otherwise, excess self-heating at connection between terminals and P.C. board may lead to smoke and / or fire of the product even when operating at rated current.
- After installing this product in your product, please make sure the self-heating is within the rated current recommended.

### P. C. Board Patterns

Use a bilateral P.C. board. Insert the BNX into the P.C.board until the root of the terminal is secured, then solder.

#### (1) Component Side View

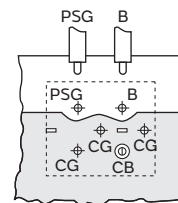

#### (2) Bottom View

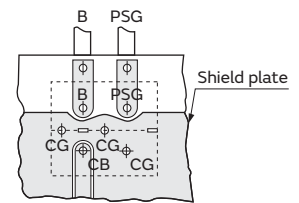

■ Copper foil pattern

### Recommended Land Pattern

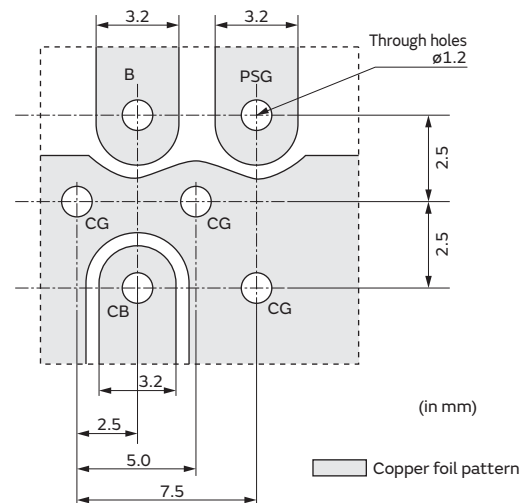

Continued on the following page. ↗



## Block Type EMIFIL<sup>®</sup> Lead Type (BNX Series) Soldering and Mounting

Continued from the preceding page. ↘

### 3. Soldering

- (1) Use Sn-3.0Ag-0.5Cu solder.
- (2) Use Rosin-based flux. Do not use strong acidic flux with halide content exceeding 0.2wt% (chlorine conversion value).
- (3) Products and the leads should not be subjected to any mechanical stress during the soldering process, or while subjected to the equivalent high temperatures.
- (4) Standard flow soldering profile

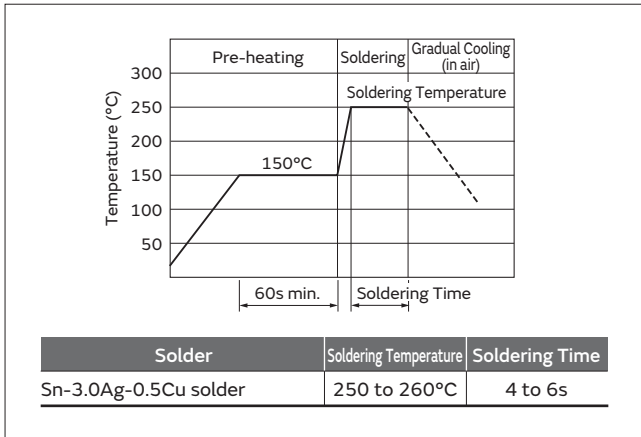

### 4. Cleaning

Clean the block Type EMIFIL<sup>®</sup>(Lead Type) in the following conditions.

- (1) Cleaning temperature should be limited to 60°C max. (40°C max for alcohol type cleaner).
- (2) Ultrasonic cleaning should comply with the following conditions, avoiding the resonance phenomenon at the mounted products and P.C.B.  
 Power: 20W/liter max.  
 Frequency: 28 to 40kHz  
 Time: 5 min. max.
- (3) Cleaner
  - (a) Alcohol type cleaner  
 Isopropyl alcohol (IPA)
  - (b) Aqueous agent  
 Pine Alpha ST-100S

- (4) There should be no residual flux or residual cleaner left after cleaning.  
 In the case of using aqueous agent, products should be dried completely after rinsing with de-ionized water in order to remove the cleaner.
- (5) The surface of products may become dirty after cleaning, but there is no deterioration on mechanical, electrical characteristics and reliability.
- (6) Other cleaning: Please contact us.

## Leaded Multilayer Ferrite Beads (BLL□ Series) Packaging

### Minimum Quantity

Part Number	Minimum Order Quantity (order in sets only) (pcs.)	
	Ammo Pack	Bulk (Bag)
<b>BLL Series</b>	2000	500

(in mm)

### Lead Type Code

Lead Type Code	Lead Length * (mm)	Packaging
Straight Type / Packaging		
<b>A2 / B</b>	28.0±1.0	Bulk
<b>DB / A</b>	20.0±1.0	Ammo Pack

\*Lead distance between reference and bottom planes except for Bulk.

### Taping Dimensions

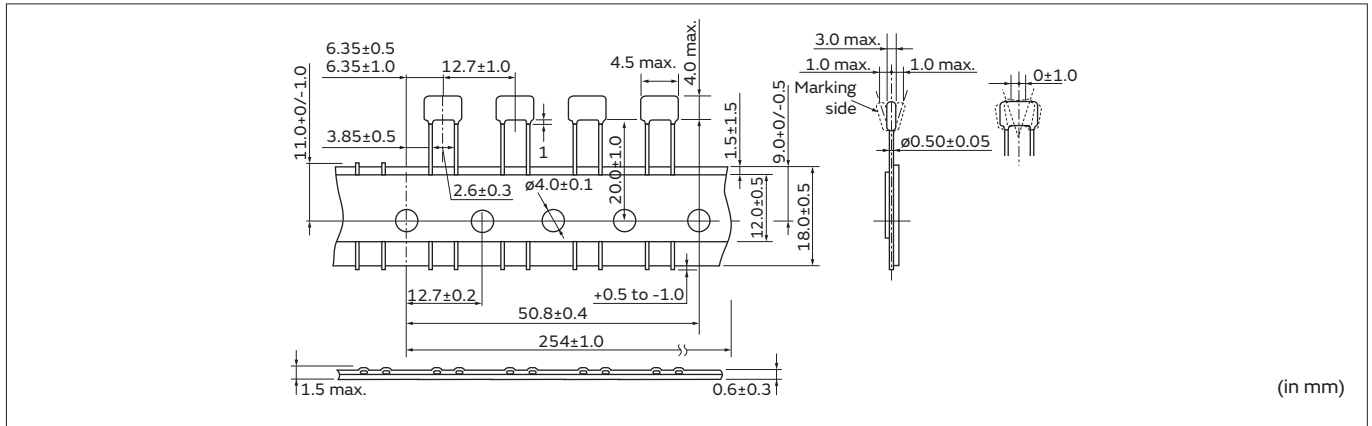

# Disc Type EMIFIL®/EMIGUARD® Lead Type (DS□/VF□ Series) Packaging

## Minimum Quantity

Part Number	Minimum Order Quantity (order in sets only) (pcs.)	
	Ammo Pack	Bulk (Bag)
VFC2H Series	2000	500
DSS1 Series	1500	250

## Lead Type Code

Lead Type Code	Lead Length (H)
Straight Type	
Q55B	25.0mm min.
Q91A	20.0±1.0mm
Q92A	16.5±1.0mm
Q93A	18.5±1.0mm

Lead Type Code	Lead Length (from bottom of the crimp)
Inside Crimp	
K1B	26.0±1.0mm
M1A	18.0±1.0mm

## Taping Dimensions

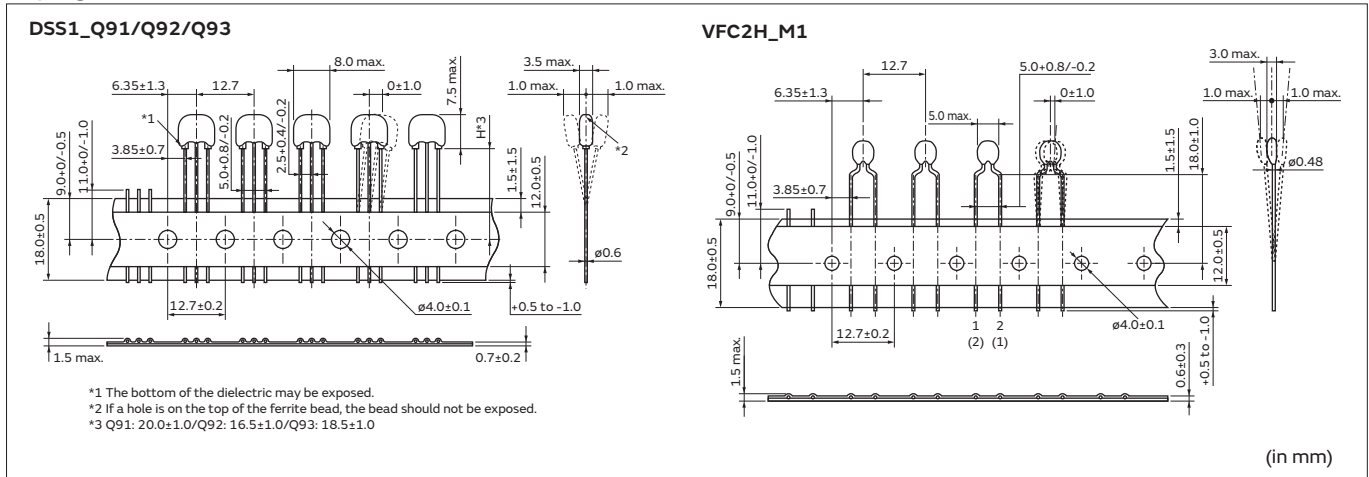

SMD Type  
Chip Ferrite Bead

SMD Type  
Chip EMIFIL®

SMD Type  
Chip Common Mode Choke Coil

SMD Type  
Block Type EMIFIL®

Lead Type  
EMI Suppression Filters

SMD Type  
Microchip Transformer (Balun)

● Part Numbering

Micro Chip Transformer for Automotive

(Part Number) 

DX	W	21	B	Z	75	11	S	L
①	②	③	④	⑤	⑥	⑦	⑧	⑨

① Product ID

Product ID	
DX	Micro Chip Transformer

② Structure

Code	Structure
W	Winding Type

③ Dimensions (LxW)

Code	Dimensions (LxW)	Size Code (inch)
21	2.0x1.2mm	0805

④ Type of Transformer

Code	Type of Transformer
B	Balun

⑤ Category

Code	Category	
Z	For Automotive	Infotainment

⑥ Port Impedance

Code	Port Impedance
75	75Ω

⑦ Characteristics

Code	Impedance Ratio
11	one to one

⑧ Rough Frequency Range

Code	Rough Frequency Range
T	50MHz to 870MHz
S	950MHz to 2150MHz

⑨ Packaging

Code	Packaging
K	Embossed Taping (ø330mm Reel)
L	Embossed Taping (ø180mm Reel)
B	Bulk

# Microchip Transformer (Balun)

## DXW21B Series 0805/2012 (inch/mm)

### Appearance/Dimensions

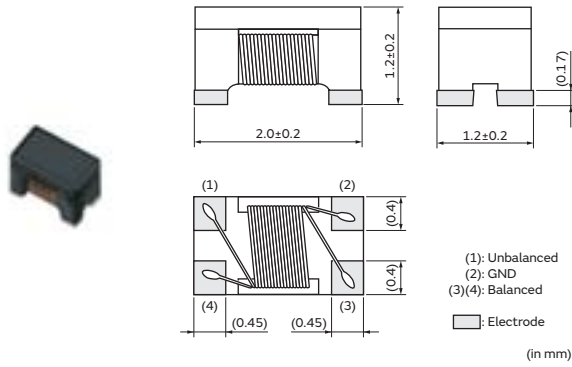

### Packaging

Code	Packaging	Minimum Quantity
L	ø180mm Embossed Taping	2000
K	ø330mm Embossed Taping	10000
B	Packing in Bulk	500

### Equivalent Circuit

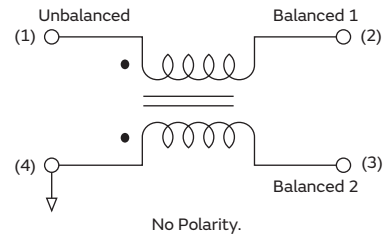

### Rated Value (□: packaging code)

Part Number		Frequency Range	Port Impedance	Insertion Loss at Freq. Range (max.)	CMRR at Freq. Range (min.)	Rated Power
For Infotainment	For Powertrain/Safety					
DXW21BZ7511S□	—	1 to 1.5GHz	75Ω - 75Ω	1.4dB	20dB	27dBm
DXW21BZ7511T□	—	50 to 870MHz	75Ω - 75Ω	1.0dB	20dB	27dBm

Operating Temperature Range: -40°C to +105°C Only for reflow soldering.

### Insertion Loss Characteristics

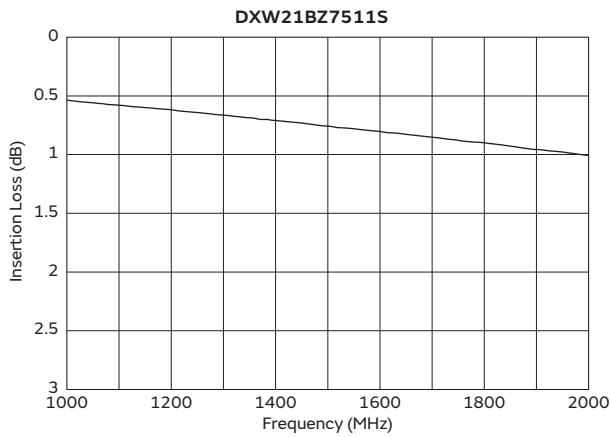

### CMRR Characteristics

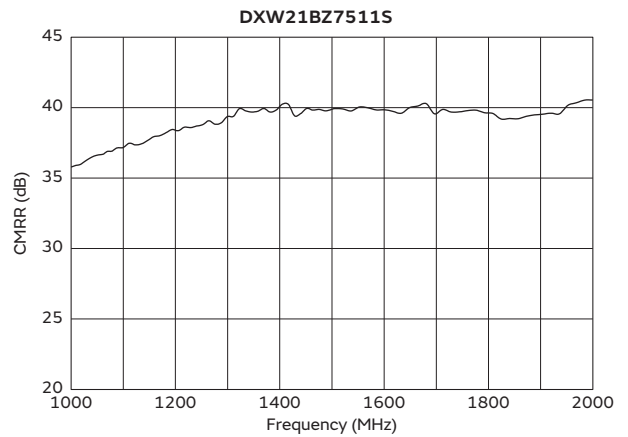

### Insertion Loss Characteristics

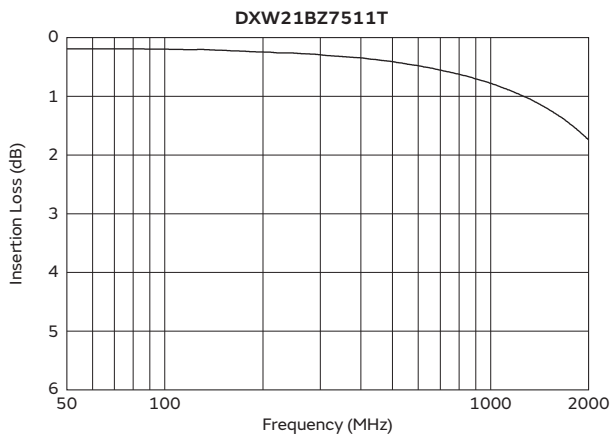

### CMRR Characteristics

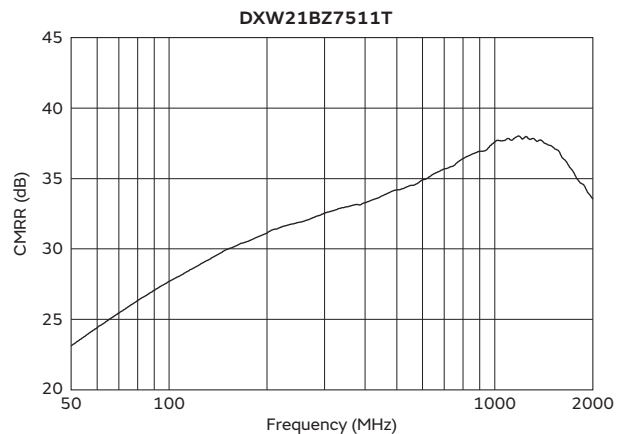

SMD Type  
 Chip Ferrite Bead

SMD Type  
 Chip EMIFIL®

SMD Type  
 Chip Common Mode Choke Coil

SMD Type  
 Block Type EMIFIL®

Lead Type  
 EMI Suppression Filters

SMD Type  
 Microchip Transformer (Balun)

## Microchip Transformer (Balun) (DX□ Series) ⚠️Caution/Notice

### ⚠️Caution

#### Rating

Do not use products beyond the rated current and rated voltage as this may create excessive heat and deteriorate the insulation resistance.

#### Soldering and Mounting

##### 1. Self-heating

Please provide special attention when mounting chip Micro Chip Transformer (DXW) series in close proximity to other products that radiate heat.

The heat generated by other products may deteriorate the insulation resistance and cause excessive heat in this component.

##### 2. Mounting Direction

Mount Micro Chip Transformer in right direction. Wrong direction, which is 90 degree rotated from right direction,

the characteristics does not come out as Micro Chip Transformer or causes not only open or short circuit but also flames or other serious trouble.

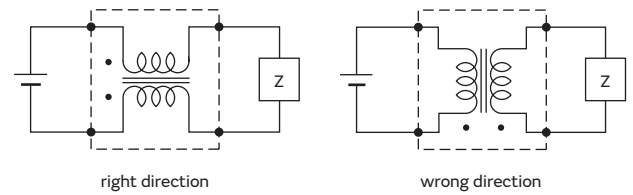

### Notice

#### Storage and Operating Conditions

##### <Operating Environment>

Do not use products in a chemical atmosphere such as chlorine gas, acid or sulfide gas.

##### <Storage and Handling Requirements>

##### 1. Storage Period

DXW series should be used within 12 months.  
Solderability should be checked if this period is exceeded.

##### 2. Storage Conditions

- (1) Storage temperature: -10 to +40 degree C  
Relative humidity: 15 to 85%  
Avoid sudden changes in temperature and humidity.
- (2) Do not store products in a chemical atmosphere such as chlorine gas, acid or sulfide gas.

#### Handling

##### 1. Resin Coating

The impedance value may change due to high cure-stress of resin to be used for coating/molding products. An open circuit issue may occur by mechanical stress caused by the resin, amount/cured shape of resin, or operating condition etc. Some resin contains some impurities or chloride possible to generate chlorine by hydrolysis under some operating condition may cause corrosion of wire of coil, leading to open circuit. So, please pay your careful attention in selecting resin in case of coating/molding the products with the resin. Prior to use the coating resin, please make sure no reliability issue is observed by evaluating products mounted on your board.

##### 2. Handling of a Substrate

After mounting products on a substrate, do not apply any stress to the product caused by bending or twisting to the substrate when cropping the substrate, inserting and removing a connector from the substrate or tightening screw to the substrate. Excessive mechanical stress may cause cracking in the Product.



# Microchip Transformer (Balun) (DX□ Series) Soldering and Mounting

## 1. Standard Land Pattern Dimensions

Land Pattern + Solder Resist  
 Land Pattern  
 Solder Resist (in mm)

Series	Standard Land Pattern Dimensions
<b>DXW21</b>	<p>● <b>Reflow Soldering</b> DXW21</p> <p>* 1 : If the pattern is made with wider than 1.2mm (DXW21) it may result in components turning around, because melting speed is different. In the worst case, short circuit between lines may occur.</p> <p>* 2 : If the pattern is made with less than 0.4mm, in the worst case, short circuit between lines may occur due to spread of soldering paste or mount placing accuracy.</p> <p>* 3 : If the pattern is made with wider than 0.8mm (DXW21), the bending strength will be reduced.</p> <p>Do not use gild pattern; excess soldering heat may dissolve metal of a copper wire.</p>

## 2. Solder Paste Printing and Adhesive Application

When reflow soldering the Micro Chip Transformer, the printing must be conducted in accordance with the following cream solder printing conditions.

If too much solder is applied, the chip will be prone to damage by mechanical and thermal stress from the PCB

and may crack. In contrast, if too little solder is applied, there is the potential that the termination strength will be insufficient, creating the potential for detachment. Standard land dimensions should be used for resist and copper foil patterns.

(in mm)

Series	Solder Paste Printing
<b>DXW21</b>	<p>● Coat the solder paste a thickness: 100-150µm</p>

## 3. Standard Soldering Conditions

### (1) Soldering Methods

Use reflow soldering methods only.

Use standard soldering conditions when soldering Micro Chip Transformer.

In cases where several different parts are soldered, each having different soldering conditions, use those conditions requiring the least heat and minimum time.

**Solder:** Use Sn-3.0Ag-0.5Cu solder.

**Flux:**

- Use Rosin-based flux, (with converting chlorine content 0.06 to 0.1(wt%), but not highly acidic flux (with Halogen content exceeding 0.2(wt)% conversion to chlorine).
- Do not use water-soluble flux.

Continued on the following page. ↗

SMD Type  
Chip Ferrite Bead

SMD Type  
Chip EMIFIL®

SMD Type  
Chip Common Mode Choke Coil

SMD Type  
Block Type EMIFIL®

Lead Type  
EMI Suppression Filters

SMD Type  
Microchip Transformer (Balun)

## Microchip Transformer (Balun) (DX□ Series) Soldering and Mounting

Continued from the preceding page. ↘

### (2) Soldering profile

#### ●Reflow Soldering profile (Sn-3.0Ag-0.5Cu)

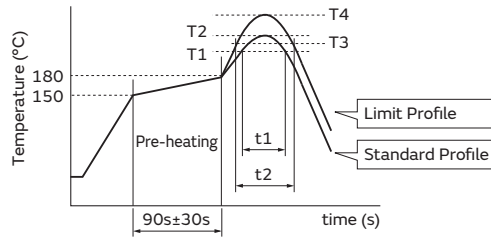

Series	Standard Profile				Limit Profile			
	Heating		Peak temperature (T2)	Cycle of reflow	Heating		Peak temperature (T4)	Cycle of reflow
	Temp. (T1)	Time. (t1)			Temp. (T3)	Time. (t2)		
<b>DXW</b>	220°C min.	30 to 60s	245±3°C	2 times max.	230°C min.	60s max.	260°C/10s	2 times max.

### (3) Reworking with Solder Iron

The following conditions must be strictly followed when using a soldering iron.

Pre-heating : 150°C 60s min.

Soldering iron power output : 30W max.

Temperature of soldering iron tip / Soldering time :  
 350°C max./3s max.

For additional methods of reworking with a soldering iron, please contact Murata engineering.

### 4. Cleaning

Do not clean.



## Microchip Transformer (Balun) (DX□ Series) Packaging

### Minimum Quantity and Dimensions of 8mm Width Embossed Tape

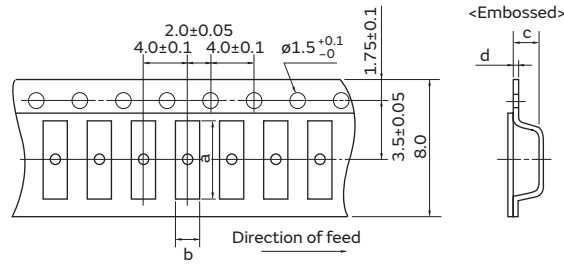

Dimension of the cavity is measured at the bottom side.

Part Number	Dimensions				Minimum Qty. (pcs.)		
					ø180mm reel	ø330mm reel	Bulk
	a	b	c	d	Embossed Tape	Embossed Tape	
<b>DXW21B</b>	2.25	1.45	1.40	0.30	2000	10000	500

(in mm)

SMD Type  
 Chip Ferrite Bead

SMD Type  
 Chip EMIFIL®

SMD Type  
 Chip Common Mode Choke Coil

SMD Type  
 Block Type EMIFIL®

Lead Type  
 EMI Suppression Filters

SMD Type  
 Microchip Transformer (Balun)



Product Guide ..... p210

**Inductors for Power Lines**

Part Numbering ..... p212  
Product Detail ..... p214  
⚠Caution/Notice ..... p304  
Soldering and Mounting ..... p308  
Packaging ..... p314

**Inductors for General Circuits**

Part Numbering ..... p317  
Product Detail ..... p318  
⚠Caution/Notice ..... p327  
Soldering and Mounting ..... p329  
Packaging ..... p334

**RF Inductors**

Part Numbering ..... p337  
Product Detail ..... p338  
⚠Caution/Notice ..... p386  
Soldering and Mounting ..... p388  
Packaging ..... p391

# Product Guide

Structure	Series	Applications	Size Code in inch (in mm)	Inductance Range		Rated Current Range	
				Min.	Max.	Min.	Max.
Wire Wound Metal Alloy Core Type	DFE201612P_D	p214	0806 (2016)	150nH	2.2μH	1.7A	6.2A
	DFE252012P_D	p216	1008 (2520)	330nH	4.7μH	1.9A	6A
	DFEG7030D	p218	2726 (7066)	1μH	22μH	2A	9.1A
	DFEH7030D	p220	2726 (7066)	1μH	22μH	2A	9.1A
	DFEG10040D	p222	4339 (109100)	1μH	47μH	2.9A	18A
	DFEH10040D	p224	4339 (109100)	1μH	47μH	2.9A	18A
	DFEG12060D	p226	5150 (130126)	1μH	47μH	3.6A	20A
	DFEH12060D	p228	5150 (130126)	1μH	47μH	3.6A	20A
Wire Wound Ferrite Core Type	LQH2MPZ_GR	p230	0806 (2016)	330nH	82μH	210mA	2.2A
	LQH2HPZ_DR	p232	1008 (2520)	470nH	22μH	270mA	1.67A
	LQH2HPZ_GR	p234	1008 (2520)	470nH	22μH	460mA	2.9A
	LQH2HPZ_JR	p236	1008 (2520)	470nH	22μH	540mA	3.5A
	LQH32CH_23	p238	1210 (3225)	1μH	22μH	250mA	800mA
	LQH32CH_33	p239	1210 (3225)	150nH	10μH	450mA	1.45A
	LQH32CH_53	p240	1210 (3225)	1μH	22μH	250mA	1A
	LQH32DZ_23	p241	1210 (3225)	1μH	470μH	60mA	800mA
	LQH32DZ_53	p242	1210 (3225)	1μH	100μH	100mA	1A
	LQH32PZ_NO	p243	1210 (3225)	470nH	120μH	200mA	3.4A
	LQH32PH_NO	p243	1210 (3225)	470nH	10μH	750mA	3.4A
	LQH32PZ_NC	p245	1210 (3225)	470nH	22μH	650mA	4.4A
	LQH32PH_NC	p245	1210 (3225)	470nH	22μH	650mA	4.4A
	LQH3NPZ_GR	p247	1212 (3030)	470nH	47μH	460mA	2.82A
	LQH3NPZ_JR	p249	1212 (3030)	680nH	47μH	570mA	2.86A
	LQH3NPZ_ME	p251	1212 (3030)	1μH	100μH	430mA	3A
	LQH44PZ_GR	p253	1515 (4040)	680nH	47μH	410mA	2.5A
	LQH43PZ_26	p255	1812 (4532)	1μH	220μH	240mA	3.4A
	LQH43PH_26	p255	1812 (4532)	1μH	220μH	240mA	3.4A
	LQH5BPZ_T0	p257	2020 (5050)	470nH	22μH	1.4A	7.7A
	MBH6045C High Current	p259	2424 (6262)	1.5μH	220μH	480mA	6.3A
	MBH6045C Low Rdc	p261	2424 (6262)	1μH	470μH	410mA	4.4A
	MDH6045C High Current	p263	2524 (6360)	1μH	220μH	440mA	5.8A
	MDH6045C Low Rdc	p265	2524 (6360)	1.2μH	470μH	340mA	5.5A
	MBH7045C High Current	p267	2828 (7272)	3.3μH	220μH	550mA	3.4A
	MBH7045C Low Rdc	p269	2828 (7272)	3.3μH	1mH	310mA	3.5A
	MDH7045C	p271	2928 (7470)	1μH	470μH	360mA	8.8A
	MDH10060C	p273	4039 (101100)	4.7μH	470μH	560mA	5.9A
	MBH10145C	p275	4141 (104104)	3.3μH	1.5mH	330mA	4.9A
	MBH12282C	p277	4949 (125125)	2μH	1mH	590mA	13A
	MDH12577C	p279	5049 (128125)	4.7μH	470μH	1A	11A
	MBH12575C	p281	5050 (128128)	2.7μH	220μH	1.2A	10A
Multilayer Type	LQM18PZ_CH	p283	0603 (1608)	1μH	2.5μH	750mA	950mA
	LQM18PZ_DH	p285	0603 (1608)	2.2μH	2.2μH	650mA	650mA
	LQM18PZ_FH	p286	0603 (1608)	2.2μH	2.2μH	700mA	700mA
	LQM21PZ_CO	p287	0805 (2012)	470nH	2.2μH	600mA	1.1A
	LQM21PZ_GO	p289	0805 (2012)	470nH	3.3μH	800mA	1.3A
	LQM21PZ_GC	p291	0805 (2012)	1μH	2.2μH	800mA	900mA
	LQM21PH_GC	p291	0805 (2012)	2.2μH	2.2μH	800mA	800mA
	LQM21PZ_GR	p293	0805 (2012)	1μH	4.7μH	800mA	1.3A
	LQM2MPZ_GO	p295	0806 (2016)	470nH	4.7μH	1.1A	1.6A
	LQM2MPZ_JH	p297	0806 (2016)	100nH	100nH	4A	4A
	LQM2HPZ_EO	p298	1008 (2520)	560nH	560nH	1.5A	1.5A
	LQM2HPZ_GO	p299	1008 (2520)	470nH	4.7μH	1.1A	1.8A
	LQM2HPZ_GC	p301	1008 (2520)	1μH	4.7μH	800mA	1.5A
	LQM2HPZ_GS	p302	1008 (2520)	2.2μH	4.7μH	1A	1.1A
	LQM2HPZ_JO	p303	1008 (2520)	1μH	3.3μH	1A	1.5A

Inductors for Power Lines

	Structure	Series	Applications	Size Code in inch (in mm)	Inductance Range		Rated Current Range		
					Min.	Max.	Min.	Max.	
RF Inductors	Multilayer Type	LQG15HZ_02	p338	<a href="#">Info-tainment</a>	0402 (1005)	1nH	270nH	110mA	1A
		LQG15HH_02	p338	<a href="#">Info-tainment</a>	0402 (1005)	1nH	270nH	110mA	1A
		LQG15WZ_02	p341	<a href="#">Info-tainment</a>	0402 (1005)	0.7nH	150nH	110mA	1.2A
		LQG15WH_02	p341	<a href="#">Info-tainment</a>	0402 (1005)	0.7nH	150nH	110mA	1.2A
		LQG18HH_00	p347	<a href="#">Info-tainment</a>	0603 (1608)	1.2nH	270nH	200mA	1.1A
	Film Type	LQP03TN_Z2	p349	<a href="#">Info-tainment</a>	0201 (0603)	0.6nH	120nH	80mA	850mA
	Wire Wound Non-Magnetic Core Type	LQW15AN_0Z	p353	<a href="#">Info-tainment</a>	0402 (1005)	1.5nH	120nH	110mA	1A
		LQW15AN_1Z	p359	<a href="#">Info-tainment</a>	0402 (1005)	1.3nH	8.4nH	640mA	1.2A
		LQW15AN_8Z	p361	<a href="#">Info-tainment</a>	0402 (1005)	1.3nH	75nH	320mA	3.15A
		LQW18AN_0Z	p368	<a href="#">Info-tainment</a>	0603 (1608)	2.2nH	470nH	75mA	850mA
		LQW18AN_1Z	p371	<a href="#">Info-tainment</a>	0603 (1608)	2.2nH	33nH	550mA	1.4A
		LQW18AN_8Z	p372	<a href="#">Info-tainment</a>	0603 (1608)	2.2nH	390nH	190mA	3.2A
		LQW18AS_0Z	p376	<a href="#">Info-tainment</a>	0603 (1608)	1.6nH	390nH	100mA	700mA
	Wire Wound Ferrite Core Type	LQW15CN_0Z	p379	<a href="#">Info-tainment</a>	0402 (1005)	18nH	200nH	390mA	1.4A
		LQW15CN_1Z	p381	<a href="#">Info-tainment</a>	0402 (1005)	20nH	560nH	300mA	2.2A
		LQW18CN_0Z	p383	<a href="#">Info-tainment</a>	0603 (1608)	4.9nH	650nH	430mA	2.6A
		LQH31HZ_03	p385	<a href="#">Info-tainment</a>	1206 (3216)	54nH	880nH	180mA	920mA
Inductors for General Circuits	Wire Wound Ferrite Core Type	LQH32NZ_23	p318	<a href="#">Info-tainment</a>	1210 (3225)	1μH	470μH	45mA	445mA
		LQH32NH_23	p318	<a href="#">Info-tainment</a>	1210 (3225)	1μH	560μH	40mA	780mA
		LQH43NZ_03	p320	<a href="#">Info-tainment</a>	1812 (4532)	1μH	2.4mH	25mA	500mA
		HEAWS	p323	<a href="#">Info-tainment</a>	4241 (107104)	10μH	10μH	5A	5A
		HEAW	p324	<a href="#">Info-tainment</a>	5551 (140130)	10μH	10μH	7.2A	7.2A
		5CCEG	p325	<a href="#">Info-tainment</a>	2222 (5656)	Please refer to the product detail page.			
		FSDVA	p326	<a href="#">Info-tainment</a>	2323 (5858)				

## ● Part Numbering

### Inductors for Power Lines for Automotive

(Part Number) 

LQ	M	21	P	Z	R54	M	G	0	D
①	②	③	④	⑤	⑥	⑦	⑧	⑨	⑩

#### ① Product ID

Product ID	
LQ	Chip Inductors (Chip Coils)

#### ② Structure

Code	Structure
H	Wire Wound Type (Ferrite Core)
M	Multilayer Type (Ferrite Core)
W	Wire Wound Type (Ferrite Core)

#### ③ Dimensions (LxW)

Code	Nominal Dimensions (LxW)	Size Code (in inch)
18	1.6x0.8mm	0603
21	2.0x1.25mm	0805
2M	2.0x1.6mm	0806
2H	2.5x2.0mm	1008
3N	3.0x3.0mm	1212
32	3.2x2.5mm	1210
43	4.5x3.2mm	1812
44	4.0x4.0mm	1515
5B	5.0x5.0mm	2020

#### ④ Applications and Characteristics

Code	Series	Applications and Characteristics
D	LQH	for Choke
C		for Choke (Coating Type)
P	LQM/LQH	for Power Line
F	LQW	for Choke

#### ⑤ Category

Code	Series	Category	
Z	LQH/LQM	Automotive	Infotainment
H			Powertrain/Safety
T	LQW	Standard Type	

#### ⑥ Inductance

Expressed by three-digit alphanumerics. The unit is micro-henry (μH). The first and second figures are significant digits, and the third figure expresses the number of zeros that follow the two figures. If there is a decimal point, it is expressed by the capital letter "R." In this case, all figures are significant digits. If inductance is less than 0.1μH, the inductance code is expressed by a combination of two figures and the capital letter "N," and the unit of inductance is nano-henry (nH). The capital letter "N" indicates the unit of "nH," and also expresses a decimal point. In this case, all figures are significant digits. For those products whose inductance values are specified using three designated digits, these values may be indicated using the closest two digits instead.

#### ⑦ Inductance Tolerance

Code	Inductance Tolerance
K	±10%
M	±20%
N	±30%

#### ⑧ Features (Except for LQH□□P/LQM□□P)

Code	Features	Series
0	Standard Type	LQW
2	Standard Type	LQH32C/32D
3	Low DC Resistance	
5	Low Profile Type	

#### ⑨ Thickness

(LQH□□P/LQM□□P Only • Except for LQH43P)

Code	Nominal Dimensions (T)
C	0.5mm
D	0.6mm
E	0.7mm
F	0.8mm
G	0.9mm
J	1.1mm
M	1.4mm
N	1.55mm
T	2.0mm

#### ⑩ Electrode (Except for LQH□□P/LQM□□P)

•Lead (Pb) Free

Code	Electrode	Series
0	Sn	LQM
3	LF Solder	LQH
H	Automotive Powertrain/Safety	LQW

#### ⑪ Specification

(LQH□□P/LQM□□P Only • Except for LQH43P)

Code	Specification
0/S	Standard Type
C	Good Bias Current Characteristics Type
H/E	High Spec Type (Low DC Resistance; Good Bias Current Characteristics Type)
R	Low DC Resistance Type

Continued on the following page. ↗

Continued from the preceding page. ↘

⑨ Thickness (LQH43P Only)

Code	Dimensions (T)
26	2.6mm

⑩ Packaging

Code	Packaging
K	Embossed Taping (ø330mm Reel)
L	Embossed Taping (ø180mm Reel)
B	Bulk
D	Paper Taping (ø180mm Reel)

## Inductors for Power Lines

# DFE201612P\_D Series 0806 (2016) inch (mm)

### Appearance/Dimensions

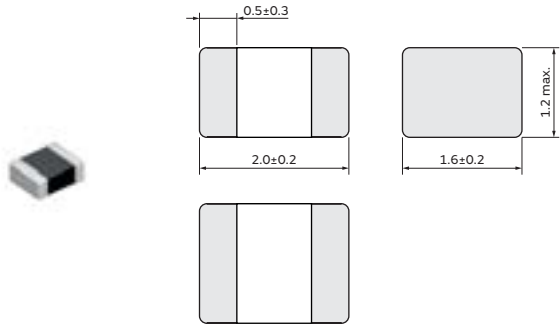

(in mm)

### Packaging

Code	Packaging	Minimum Quantity
=P2	ø180mm Embossed Taping	3000

### Rated Value (□: packaging code)

Part Number		Inductance	Inductance Test Frequency	Rated Current (Isat)*	Rated Current (Itemp)*	Max. of DC Resistance
Infotainment	Powertrain/Safety					
DFE201612PD-R15M□	—	0.15μH ±20%	1MHz	6200mA	5200mA	0.018Ω
DFE201612PD-R24M□	—	0.24μH ±20%	1MHz	5000mA	4000mA	0.022Ω
DFE201612PD-R33M□	—	0.33μH ±20%	1MHz	4500mA	3800mA	0.026Ω
DFE201612PD-R47M□	—	0.47μH ±20%	1MHz	3800mA	3200mA	0.032Ω
DFE201612PD-R68M□	—	0.68μH ±20%	1MHz	3100mA	2500mA	0.046Ω
DFE201612PD-1R0M□	—	1.0μH ±20%	1MHz	2700mA	2200mA	0.060Ω
DFE201612PD-1R5M□	—	1.5μH ±20%	1MHz	2000mA	1700mA	0.098Ω
DFE201612PD-2R2M□	—	2.2μH ±20%	1MHz	1700mA	1200mA	0.172Ω

Operating temp.range (Self-temp.rise included): -40 to 125°C

Absolute maximum voltage: 10V DC

Inductance:

Measured with an LCR meter 4284A (Keysight) or equivalent.

RDC:

Measured with a Resistance Hitester 3541 (HIOKI) or equivalent.

Only for reflow soldering

\*Isat: Rated Current based on Inductance change

\*Itemp: Rated Current based on Temperature rise

Rated current (Isat) is specified when the decrease of the initial inductance value at 30%. (The ambient reference temperature is 20°C.)

Rated current (Itemp) is specified when temperature of inductor the is raised 40°C by DC current. (The ambient reference temperature is 20°C.)

Class of Magnetic Shield: Metal Alloy

### Inductance-Current Characteristics (Typ.)

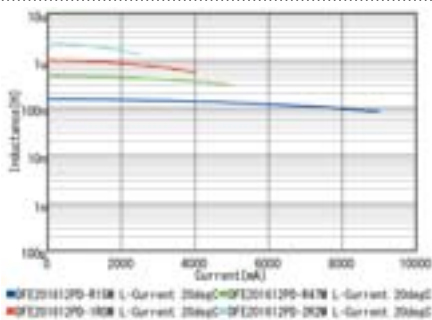

### Temperature Rise Characteristics (Typ.)

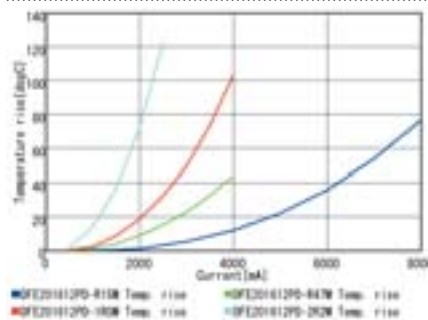

### Inductance-Frequency Characteristics (Typ.)

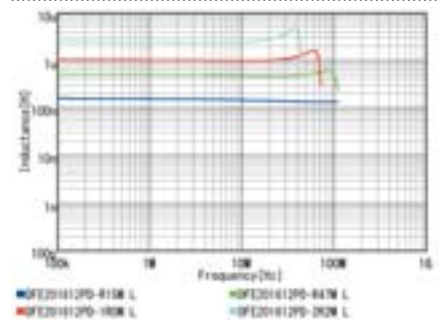

Continued on the following page. ↗



Continued from the preceding page. ↘

### Notice (Rating)

Max. current (DC, AC) as function of ambient temperature (derating curve).

Derating of Rated Current

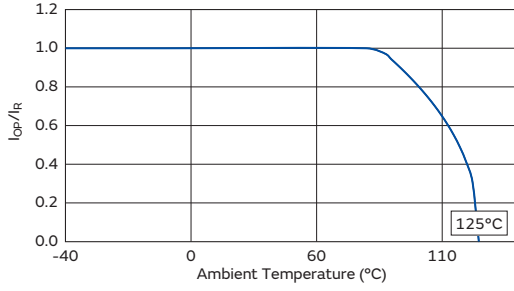

## Inductors for Power Lines

# DFE252012P\_D Series 1008 (2520) inch (mm)

### Appearance/Dimensions

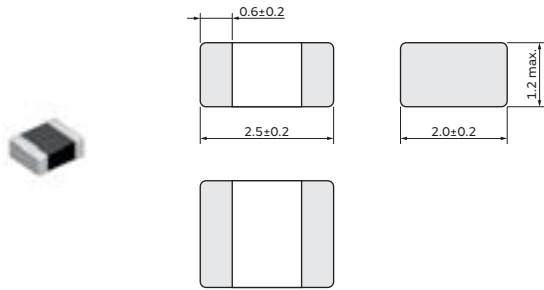

(in mm)

### Packaging

Code	Packaging	Minimum Quantity
=P2	ø180mm Embossed Taping	3000

### Rated Value (□: packaging code)

Part Number		Inductance	Inductance Test Frequency	Rated Current (Isat)*	Rated Current (Itemp)*	Max. of DC Resistance
Infotainment	Powertrain/Safety					
DFE252012PD-R33M□	—	0.33μH ±20%	1MHz	6000mA	4600mA	0.023Ω
DFE252012PD-R47M□	—	0.47μH ±20%	1MHz	5200mA	4000mA	0.027Ω
DFE252012PD-R68M□	—	0.68μH ±20%	1MHz	4300mA	3500mA	0.037Ω
DFE252012PD-1R0M□	—	1.0μH ±20%	1MHz	3800mA	3200mA	0.042Ω
DFE252012PD-1R5M□	—	1.5μH ±20%	1MHz	3300mA	2600mA	0.060Ω
DFE252012PD-2R2M□	—	2.2μH ±20%	1MHz	2800mA	2200mA	0.084Ω
DFE252012PD-3R3M□	—	3.3μH ±20%	1MHz	2100mA	1700mA	0.140Ω
DFE252012PD-4R7M□	—	4.7μH ±20%	1MHz	1900mA	1400mA	0.200Ω

Operating temp.range (Self-temp.rise included): -40 to 125°C

Absolute maximum voltage: 20V DC

Inductance:

Measured with an LCR meter 4284A (Keysight) or equivalent.

RDC:

Measured with a Resistance Hitester 3541 (HIOKI) or equivalent.

Only for reflow soldering

\*Isat: Rated Current based on Inductance change

\*Itemp: Rated Current based on Temperature rise

Rated current (Isat) is specified when the decrease of the initial inductance value at 30%. (The ambient reference temperature is 20°C.)

Rated current (Itemp) is specified when temperature of inductor the is raised 40°C by DC current. (The ambient reference temperature is 20°C.)

Class of Magnetic Shield: Metal Alloy

### Inductance-Current Characteristics (Typ.)

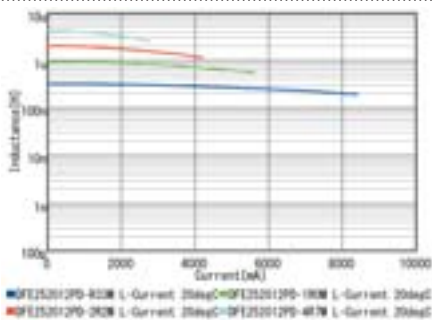

### Temperature Rise Characteristics (Typ.)

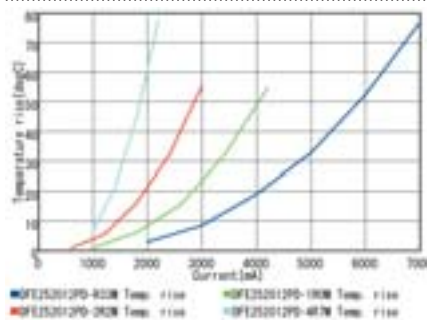

### Inductance-Frequency Characteristics (Typ.)

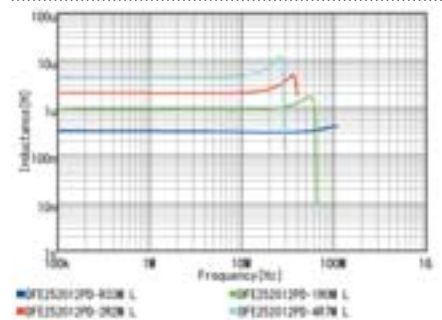

Continued on the following page. ↗

Continued from the preceding page. ↘

### Notice (Rating)

Max. current (DC, AC) as function of ambient temperature (derating curve).

Derating of Rated Current

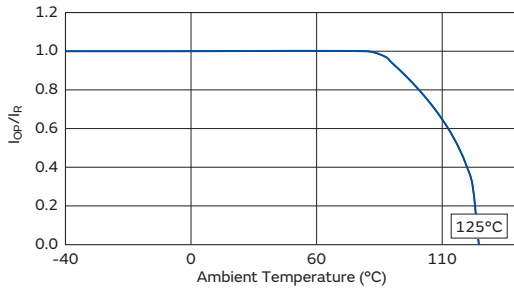

## Inductors for Power Lines

# DFEG7030D Series 2726 (7066) inch (mm)

### Appearance/Dimensions

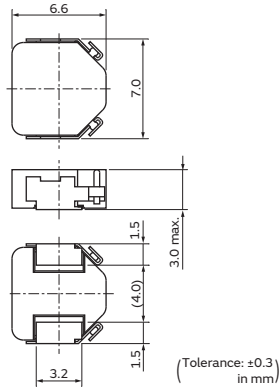

### Packaging

Code	Packaging	Minimum Quantity
=P3	ø330mm Embossed Taping	1000

### Rated Value (□: packaging code)

Part Number		Inductance	Inductance Test Frequency	Rated Current (I <sub>sat</sub> )*	Rated Current (I <sub>temp</sub> )*	Max. of DC Resistance
Infotainment	Powertrain/Safety					
—	DFEG7030D-1R0M□	1.0μH ±20%	0.1MHz	9000mA	9100mA	0.0099Ω
—	DFEG7030D-1R5M□	1.5μH ±20%	0.1MHz	7300mA	7600mA	0.0150Ω
—	DFEG7030D-2R2M□	2.2μH ±20%	0.1MHz	6900mA	7100mA	0.0180Ω
—	DFEG7030D-3R3M□	3.3μH ±20%	0.1MHz	5300mA	5400mA	0.0290Ω
—	DFEG7030D-4R7M□	4.7μH ±20%	0.1MHz	4200mA	4200mA	0.0410Ω
—	DFEG7030D-5R6M□	5.6μH ±20%	0.1MHz	4100mA	3800mA	0.0540Ω
—	DFEG7030D-6R8M□	6.8μH ±20%	0.1MHz	3900mA	3500mA	0.0590Ω
—	DFEG7030D-8R2M□	8.2μH ±20%	0.1MHz	3200mA	3100mA	0.0780Ω
—	DFEG7030D-100M□	10μH ±20%	0.1MHz	3200mA	3000mA	0.0820Ω
—	DFEG7030D-150M□	15μH ±20%	0.1MHz	2400mA	2200mA	0.1470Ω
—	DFEG7030D-220M□	22μH ±20%	0.1MHz	2000mA	1900mA	0.1980Ω

Operating temp.range (Self-temp.rise included): -40 to 125°C

Absolute maximum voltage: 50V DC

Inductance:

Measured with an LCR meter 4284A (Keysight) or equivalent.

RDC:

Measured with a Resistance Hitester 3541 (HIOKI) or equivalent.

Only for reflow soldering

\*I<sub>sat</sub>: Rated Current based on Inductance change

\*I<sub>temp</sub>: Rated Current based on Temperature rise

Rated current (I<sub>sat</sub>) is specified when the decrease of the initial inductance value at 20%. (The ambient reference temperature is 25°C.)

Rated current (I<sub>temp</sub>) is specified when temperature of inductor the is raised 40°C by DC current. (The ambient reference temperature is 25°C.)

Class of Magnetic Shield: Metal Alloy

### Inductance-Current Characteristics (Typ.)

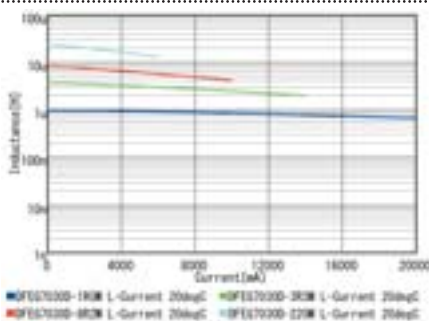

### Temperature Rise Characteristics (Typ.)

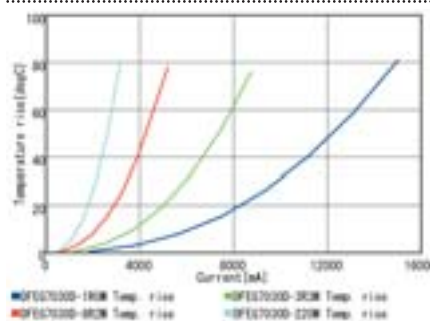

### Inductance-Frequency Characteristics (Typ.)

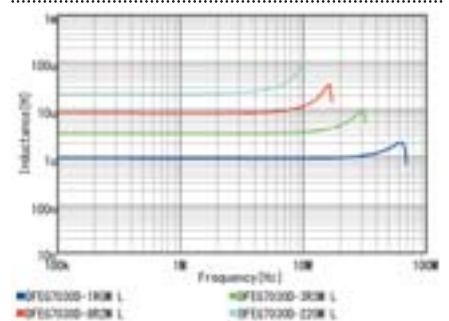

Continued on the following page. ↗

Continued from the preceding page. ↘

### Notice (Rating)

Max. current (DC, AC) as function of ambient temperature (derating curve).

Derating of Rated Current

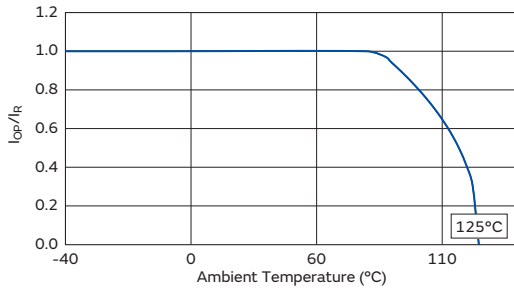

## Inductors for Power Lines

# DFEH7030D Series 2726 (7066) inch (mm)

### Appearance/Dimensions

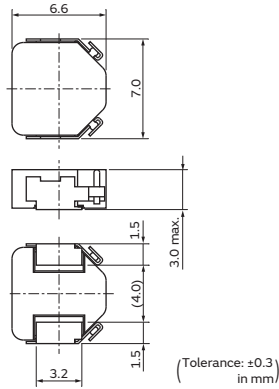

### Packaging

Code	Packaging	Minimum Quantity
=P3	ø330mm Embossed Taping	1000

### Rated Value (□: packaging code)

Part Number		Inductance	Inductance Test Frequency	Rated Current (I <sub>sat</sub> )*	Rated Current (I <sub>temp</sub> )*	Max. of DC Resistance
Infotainment	Powertrain/Safety					
—	DFEH7030D-1R0M□	1.0μH ±20%	0.1MHz	9000mA	9100mA	0.0099Ω
—	DFEH7030D-1R5M□	1.5μH ±20%	0.1MHz	7300mA	7600mA	0.0150Ω
—	DFEH7030D-2R2M□	2.2μH ±20%	0.1MHz	6900mA	7100mA	0.0180Ω
—	DFEH7030D-3R3M□	3.3μH ±20%	0.1MHz	5300mA	5400mA	0.0290Ω
—	DFEH7030D-4R7M□	4.7μH ±20%	0.1MHz	4200mA	4200mA	0.0410Ω
—	DFEH7030D-5R6M□	5.6μH ±20%	0.1MHz	4100mA	3800mA	0.0540Ω
—	DFEH7030D-6R8M□	6.8μH ±20%	0.1MHz	3900mA	3500mA	0.0590Ω
—	DFEH7030D-8R2M□	8.2μH ±20%	0.1MHz	3200mA	3100mA	0.0780Ω
—	DFEH7030D-100M□	10μH ±20%	0.1MHz	3200mA	3000mA	0.0820Ω
—	DFEH7030D-150M□	15μH ±20%	0.1MHz	2400mA	2200mA	0.1470Ω
—	DFEH7030D-220M□	22μH ±20%	0.1MHz	2000mA	1900mA	0.1980Ω

Operating temp.range (Self-temp.rise included): -40 to 155°C

Absolute maximum voltage: 50V DC

Inductance:

Measured with an LCR meter 4284A (Keysight) or equivalent.

RDC:

Measured with a Resistance Hitester 3541 (HIOKI) or equivalent.

Only for reflow soldering

\*I<sub>sat</sub>: Rated Current based on Inductance change

\*I<sub>temp</sub>: Rated Current based on Temperature rise

Rated current (I<sub>sat</sub>) is specified when the decrease of the initial inductance value at 20%. (The ambient reference temperature is 25°C.)

Rated current (I<sub>temp</sub>) is specified when temperature of inductor the is raised 40°C by DC current. (The ambient reference temperature is 25°C.)

Class of Magnetic Shield: Metal Alloy

### Inductance-Current Characteristics (Typ.)

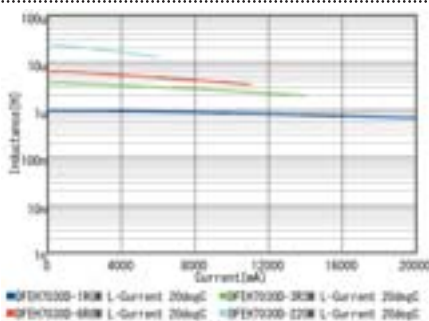

### Temperature Rise Characteristics (Typ.)

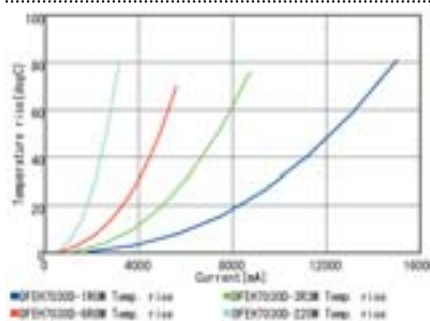

### Inductance-Frequency Characteristics (Typ.)

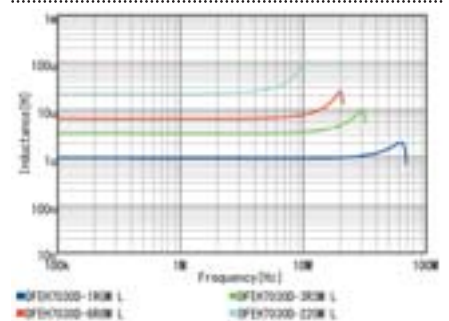

Continued on the following page. ↗

Continued from the preceding page. ↘

### Notice (Rating)

Max. current (DC, AC) as function of ambient temperature (derating curve).

Derating of Rated Current

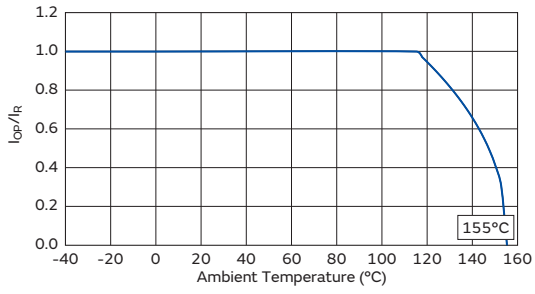

## Inductors for Power Lines

# DFEG10040D Series 4339 (109100) inch (mm)

### Appearance/Dimensions

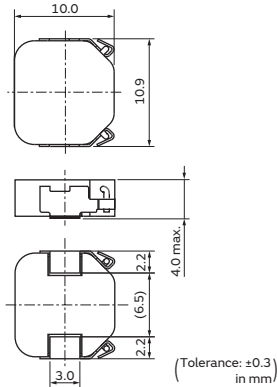

### Packaging

Code	Packaging	Minimum Quantity
=P3	ø330mm Embossed Taping	500

### Rated Value (□: packaging code)

Part Number		Inductance	Inductance Test Frequency	Rated Current (Isat)*	Rated Current (Itemp)*	Max. of DC Resistance
Infotainment	Powertrain/Safety					
—	DFEG10040D-1R0M□	1.0μH ±20%	0.1MHz	18000mA	17000mA	0.0035Ω
—	DFEG10040D-1R5M□	1.5μH ±20%	0.1MHz	14000mA	14000mA	0.0050Ω
—	DFEG10040D-2R2M□	2.2μH ±20%	0.1MHz	11000mA	12000mA	0.0075Ω
—	DFEG10040D-3R3M□	3.3μH ±20%	0.1MHz	10000mA	10000mA	0.0120Ω
—	DFEG10040D-4R7M□	4.7μH ±20%	0.1MHz	7300mA	8800mA	0.0160Ω
—	DFEG10040D-5R6M□	5.6μH ±20%	0.1MHz	6900mA	8000mA	0.0180Ω
—	DFEG10040D-6R8M□	6.8μH ±20%	0.1MHz	6500mA	6400mA	0.0230Ω
—	DFEG10040D-8R2M□	8.2μH ±20%	0.1MHz	5600mA	5900mA	0.0290Ω
—	DFEG10040D-100M□	10μH ±20%	0.1MHz	5500mA	5700mA	0.0330Ω
—	DFEG10040D-150M□	15μH ±20%	0.1MHz	4400mA	5200mA	0.0470Ω
—	DFEG10040D-220M□	22μH ±20%	0.1MHz	4000mA	3800mA	0.0700Ω
—	DFEG10040D-330M□	33μH ±20%	0.1MHz	3000mA	3300mA	0.1070Ω
—	DFEG10040D-470M□	47μH ±20%	0.1MHz	2900mA	2500mA	0.1640Ω

Operating temp.range (Self-temp.rise included): -40 to 125°C

Absolute maximum voltage: 50V DC

Inductance:

Measured with an LCR meter 4284A (Keysight) or equivalent.

RDC:

Measured with a Resistance Hitester 3541 (HIOKI) or equivalent.

Only for reflow soldering

\*Isat: Rated Current based on Inductance change

\*Itemp: Rated Current based on Temperature rise

Rated current (Isat) is specified when the decrease of the initial inductance value at 20%. (The ambient reference temperature is 25°C.)

Rated current (Itemp) is specified when temperature of inductor the is raised 40°C by DC current. (The ambient reference temperature is 25°C.)

Class of Magnetic Shield: Metal Alloy

### Inductance-Current Characteristics (Typ.)



### Temperature Rise Characteristics (Typ.)

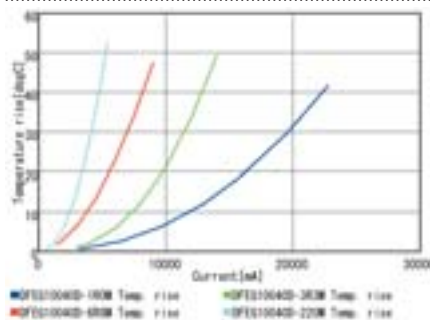

### Inductance-Frequency Characteristics (Typ.)

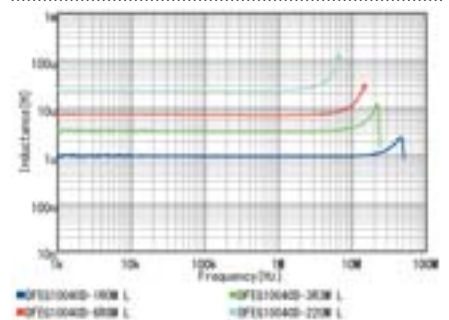

Continued on the following page. ↗



Continued from the preceding page. ↘

### Notice (Rating)

Max. current (DC, AC) as function of ambient temperature (derating curve).

Derating of Rated Current

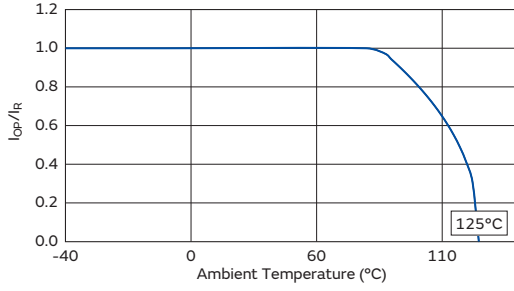

## Inductors for Power Lines

# DFEH10040D Series 4339 (109100) inch (mm)

### Appearance/Dimensions

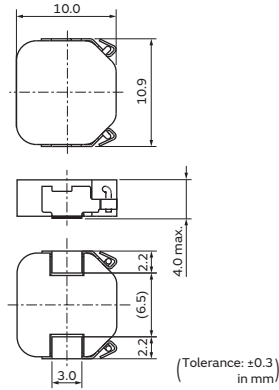

### Packaging

Code	Packaging	Minimum Quantity
=P3	ø330mm Embossed Taping	500

### Rated Value (□: packaging code)

Part Number		Inductance	Inductance Test Frequency	Rated Current (Isat)*	Rated Current (Itemp)*	Max. of DC Resistance
Infotainment	Powertrain/Safety					
—	DFEH10040D-1R0M□	1.0μH ±20%	0.1MHz	18000mA	17000mA	0.0035Ω
—	DFEH10040D-1R5M□	1.5μH ±20%	0.1MHz	14000mA	14000mA	0.0050Ω
—	DFEH10040D-2R2M□	2.2μH ±20%	0.1MHz	11000mA	12000mA	0.0075Ω
—	DFEH10040D-3R3M□	3.3μH ±20%	0.1MHz	10000mA	10000mA	0.0120Ω
—	DFEH10040D-4R7M□	4.7μH ±20%	0.1MHz	7300mA	8800mA	0.0160Ω
—	DFEH10040D-5R6M□	5.6μH ±20%	0.1MHz	6900mA	8000mA	0.0180Ω
—	DFEH10040D-6R8M□	6.8μH ±20%	0.1MHz	6500mA	6400mA	0.0230Ω
—	DFEH10040D-8R2M□	8.2μH ±20%	0.1MHz	5600mA	5900mA	0.0290Ω
—	DFEH10040D-100M□	10μH ±20%	0.1MHz	5500mA	5700mA	0.0330Ω
—	DFEH10040D-150M□	15μH ±20%	0.1MHz	4400mA	5200mA	0.0470Ω
—	DFEH10040D-220M□	22μH ±20%	0.1MHz	4000mA	3800mA	0.0700Ω
—	DFEH10040D-330M□	33μH ±20%	0.1MHz	3000mA	3300mA	0.1070Ω
—	DFEH10040D-470M□	47μH ±20%	0.1MHz	2900mA	2500mA	0.1640Ω

Operating temp.range (Self-temp.rise included): -40 to 155°C

Absolute maximum voltage: 50V DC

Inductance:

Measured with an LCR meter 4284A (Keysight) or equivalent.

RDC:

Measured with a Resistance Hitester 3541 (HIOKI) or equivalent.

Only for reflow soldering

\*Isat: Rated Current based on Inductance change

\*Itemp: Rated Current based on Temperature rise

Rated current (Isat) is specified when the decrease of the initial inductance value at 20%. (The ambient reference temperature is 25°C.)

Rated current (Itemp) is specified when temperature of inductor the is raised 40°C by DC current. (The ambient reference temperature is 25°C.)

Class of Magnetic Shield: Metal Alloy

### Inductance-Current Characteristics (Typ.)



### Temperature Rise Characteristics (Typ.)

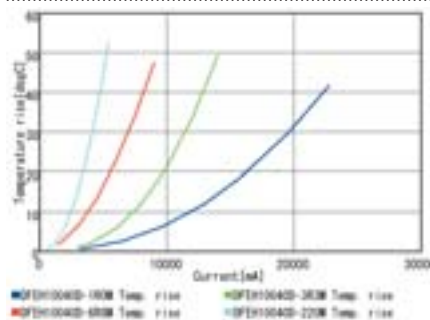

### Inductance-Frequency Characteristics (Typ.)

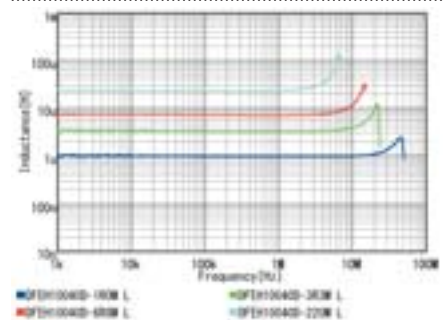

Continued on the following page. ↗

Continued from the preceding page. ↘

### Notice (Rating)

Max. current (DC, AC) as function of ambient temperature (derating curve).

Derating of Rated Current

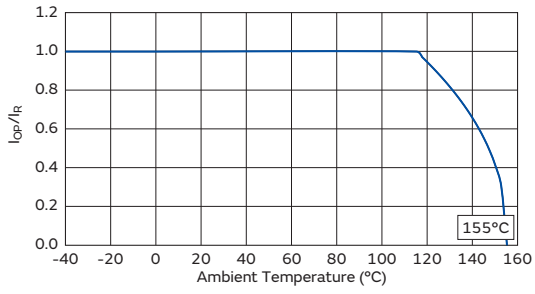

Inductors for Power Lines  
 Inductors for General Circuits  
 RF Inductors

## Inductors for Power Lines

# DFEG12060D Series 5150 (130126) inch (mm)

### Appearance/Dimensions

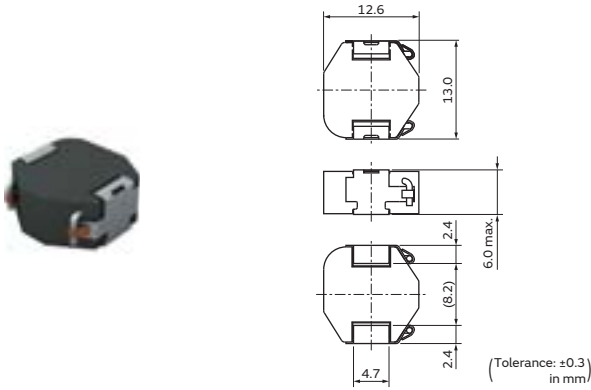

### Packaging

Code	Packaging	Minimum Quantity
=P3	ø330mm Embossed Taping	500

### Rated Value (□: packaging code)

Part Number		Inductance	Inductance Test Frequency	Rated Current (Isat)*	Rated Current (Itemp)*	Max. of DC Resistance
Infotainment	Powertrain/Safety					
—	DFEG12060D-1R0M□	1.0μH ±20%	0.1MHz	19000mA	20000mA	0.0029Ω
—	DFEG12060D-1R5M□	1.5μH ±20%	0.1MHz	17000mA	17000mA	0.0036Ω
—	DFEG12060D-2R2M□	2.2μH ±20%	0.1MHz	16000mA	16000mA	0.0044Ω
—	DFEG12060D-3R3M□	3.3μH ±20%	0.1MHz	14000mA	13000mA	0.0063Ω
—	DFEG12060D-4R7M□	4.7μH ±20%	0.1MHz	11000mA	10000mA	0.0110Ω
—	DFEG12060D-5R6M□	5.6μH ±20%	0.1MHz	10000mA	10000mA	0.0110Ω
—	DFEG12060D-6R8M□	6.8μH ±20%	0.1MHz	8300mA	9000mA	0.0140Ω
—	DFEG12060D-8R2M□	8.2μH ±20%	0.1MHz	8300mA	8000mA	0.0170Ω
—	DFEG12060D-100M□	10μH ±20%	0.1MHz	6600mA	7900mA	0.0200Ω
—	DFEG12060D-150M□	15μH ±20%	0.1MHz	5600mA	6600mA	0.0280Ω
—	DFEG12060D-220M□	22μH ±20%	0.1MHz	4900mA	6000mA	0.0350Ω
—	DFEG12060D-330M□	33μH ±20%	0.1MHz	3400mA	4200mA	0.0540Ω
—	DFEG12060D-470M□	47μH ±20%	0.1MHz	3000mA	3600mA	0.0790Ω

Operating temp.range (Self-temp.rise included): -40 to 125°C

Absolute maximum voltage: 50V DC

Inductance:

Measured with an LCR meter 4284A (Keysight) or equivalent.

RDC:

Measured with a Resistance Hitester 3541 (HIOKI) or equivalent.

Only for reflow soldering

\*Isat: Rated Current based on Inductance change

\*Itemp: Rated Current based on Temperature rise

Rated current (Isat) is specified when the decrease of the initial inductance value at 20%. (The ambient reference temperature is 25°C.)

Rated current (Itemp) is specified when temperature of inductor the is raised 40°C by DC current. (The ambient reference temperature is 25°C.)

Class of Magnetic Shield: Metal Alloy

### Inductance-Current Characteristics (Typ.)



### Temperature Rise Characteristics (Typ.)

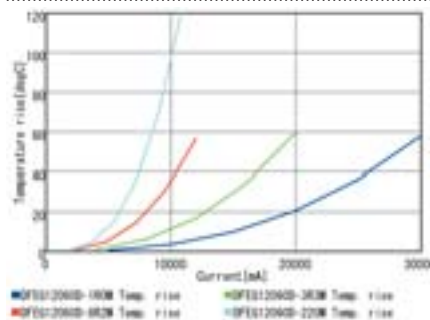

### Inductance-Frequency Characteristics (Typ.)

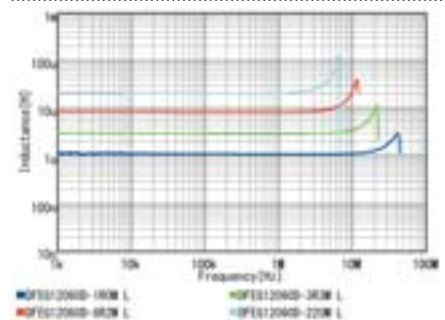

Continued on the following page. ↗

Continued from the preceding page. ↘

### Notice (Rating)

Max. current (DC, AC) as function of ambient temperature (derating curve).

Derating of Rated Current

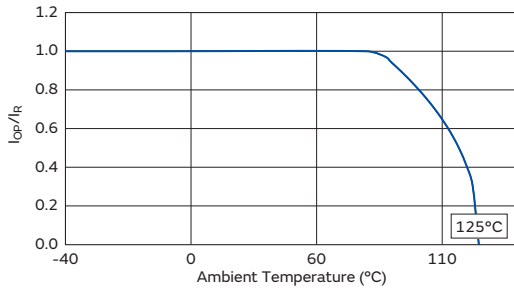

## Inductors for Power Lines

# DFEH12060D Series 5150 (130126) inch (mm)

### Appearance/Dimensions

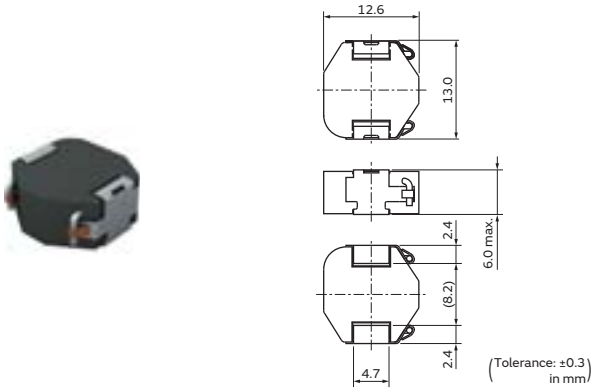

### Packaging

Code	Packaging	Minimum Quantity
=P3	ø330mm Embossed Taping	500

### Rated Value (□: packaging code)

Part Number		Inductance	Inductance Test Frequency	Rated Current (Isat)*	Rated Current (Itemp)*	Max. of DC Resistance
Infotainment	Powertrain/Safety					
—	DFEH12060D-1R0M□	1.0μH ±20%	0.1MHz	19000mA	20000mA	0.0029Ω
—	DFEH12060D-1R5M□	1.5μH ±20%	0.1MHz	17000mA	17000mA	0.0036Ω
—	DFEH12060D-2R2M□	2.2μH ±20%	0.1MHz	16000mA	16000mA	0.0044Ω
—	DFEH12060D-3R3M□	3.3μH ±20%	0.1MHz	14000mA	13000mA	0.0063Ω
—	DFEH12060D-4R7M□	4.7μH ±20%	0.1MHz	11000mA	10000mA	0.0110Ω
—	DFEH12060D-5R6M□	5.6μH ±20%	0.1MHz	10000mA	10000mA	0.0110Ω
—	DFEH12060D-6R8M□	6.8μH ±20%	0.1MHz	8300mA	9000mA	0.0140Ω
—	DFEH12060D-8R2M□	8.2μH ±20%	0.1MHz	8300mA	8000mA	0.0170Ω
—	DFEH12060D-100M□	10μH ±20%	0.1MHz	6600mA	7900mA	0.0200Ω
—	DFEH12060D-150M□	15μH ±20%	0.1MHz	5600mA	6600mA	0.0280Ω
—	DFEH12060D-220M□	22μH ±20%	0.1MHz	4900mA	6000mA	0.0350Ω
—	DFEH12060D-330M□	33μH ±20%	0.1MHz	3400mA	4200mA	0.0540Ω
—	DFEH12060D-470M□	47μH ±20%	0.1MHz	3000mA	3600mA	0.0790Ω

Operating temp.range (Self-temp.rise included): -40 to 155°C

Absolute maximum voltage: 50V DC

Inductance:

Measured with an LCR meter 4284A (Keysight) or equivalent.

RDC:

Measured with a Resistance Hitester 3541 (HIOKI) or equivalent.

Only for reflow soldering

\*Isat: Rated Current based on Inductance change

\*Itemp: Rated Current based on Temperature rise

Rated current (Isat) is specified when the decrease of the initial inductance value at 20%. (The ambient reference temperature is 25°C.)

Rated current (Itemp) is specified when temperature of inductor the is raised 40°C by DC current. (The ambient reference temperature is 25°C.)

Class of Magnetic Shield: Metal Alloy

### Inductance-Current Characteristics (Typ.)



### Temperature Rise Characteristics (Typ.)

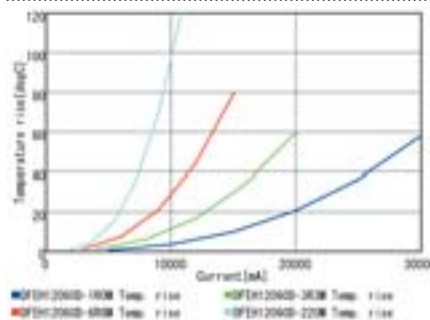

### Inductance-Frequency Characteristics (Typ.)

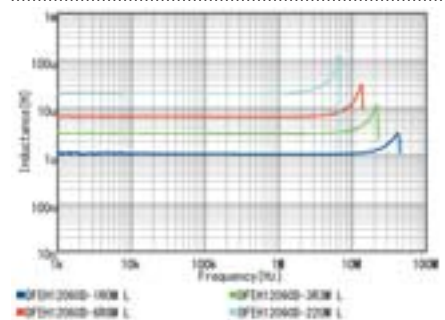

Continued on the following page. ↗

Continued from the preceding page. ↘

### Notice (Rating)

Max. current (DC, AC) as function of ambient temperature (derating curve).

Derating of Rated Current

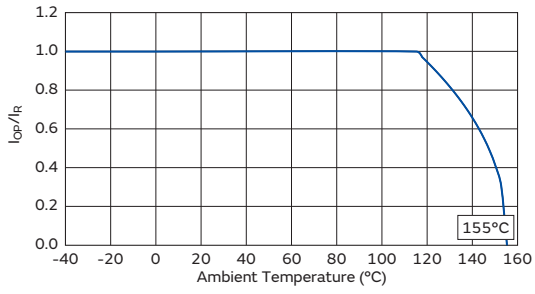

## Inductors for Power Lines

# LQH2MPZ\_GR Series 0806 (2016) inch (mm)

### Appearance/Dimensions

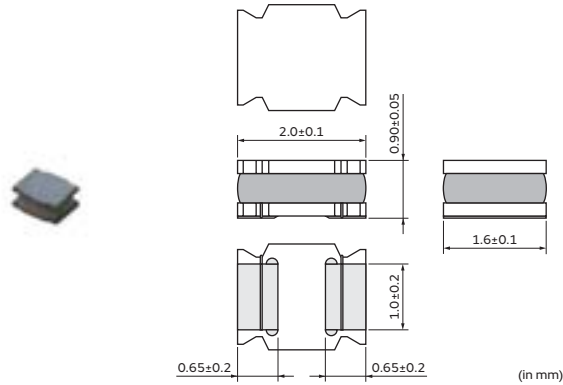

### Packaging

Code	Packaging	Minimum Quantity
L	ø180mm Embossed Taping	3000

### Rated Value (□: packaging code)

Part Number		Inductance	Inductance Test Frequency	Rated Current (Isat)*	Rated Current (Itemp)*	DC Resistance	S.R.F.* (min.)
Infotainment	Powertrain/Safety						
LQH2MPZR33NGR□	—	0.33μH ±30%	1MHz	2200mA	1130mA(Ambient temp.85°C) 670mA(Ambient temp.105°C)	0.15Ω±20%	130MHz
LQH2MPZR47NGR□	—	0.47μH ±30%	1MHz	1950mA	1060mA(Ambient temp.85°C) 630mA(Ambient temp.105°C)	0.18Ω±20%	120MHz
LQH2MPZ1R0NGR□	—	1.0μH ±30%	1MHz	1550mA	900mA(Ambient temp.85°C) 540mA(Ambient temp.105°C)	0.25Ω±20%	100MHz
LQH2MPZ1R5NGR□	—	1.5μH ±30%	1MHz	1330mA	790mA(Ambient temp.85°C) 470mA(Ambient temp.105°C)	0.32Ω±20%	60MHz
LQH2MPZ2R2MGR□	—	2.2μH ±20%	1MHz	1180mA	680mA(Ambient temp.85°C) 400mA(Ambient temp.105°C)	0.39Ω±20%	50MHz
LQH2MPZ3R3MGR□	—	3.3μH ±20%	1MHz	1020mA	640mA(Ambient temp.85°C) 380mA(Ambient temp.105°C)	0.47Ω±20%	45MHz
LQH2MPZ4R7MGR□	—	4.7μH ±20%	1MHz	870mA	580mA(Ambient temp.85°C) 340mA(Ambient temp.105°C)	0.60Ω±20%	40MHz
LQH2MPZ6R8MGR□	—	6.8μH ±20%	1MHz	730mA	530mA(Ambient temp.85°C) 310mA(Ambient temp.105°C)	0.72Ω±20%	35MHz
LQH2MPZ100MGR□	—	10μH ±20%	1MHz	610mA	480mA(Ambient temp.85°C) 280mA(Ambient temp.105°C)	0.88Ω±20%	30MHz
LQH2MPZ150MGR□	—	15μH ±20%	1MHz	490mA	340mA(Ambient temp.85°C) 200mA(Ambient temp.105°C)	1.7Ω±20%	25MHz
LQH2MPZ220MGR□	—	22μH ±20%	1MHz	410mA	290mA(Ambient temp.85°C) 170mA(Ambient temp.105°C)	2.1Ω±20%	20MHz
LQH2MPZ330MGR□	—	33μH ±20%	1MHz	310mA	200mA(Ambient temp.85°C) 120mA(Ambient temp.105°C)	4.3Ω±20%	15MHz
LQH2MPZ470MGR□	—	47μH ±20%	1MHz	270mA	180mA(Ambient temp.85°C) 110mA(Ambient temp.105°C)	5.3Ω±20%	10MHz

Operating temp.range (Self-temp.rise included): -40 to 125°C

Operating temp.range (Self-temp.rise not included): -40 to 105°C

Class of Magnetic Shield: Ferrite Core

Only for reflow soldering

\*Isat: Rated Current based on Inductance change

\*Itemp: Rated Current based on Temperature rise

\*S.R.F.: Self Resonant Frequency

When rated current is applied to the products, inductance will be within ±30% of initial inductance value range. Keep the temperature (ambient temperature plus self-generation of heat) under 125°C. When rated current is applied to the products, the self-temperature rise shall be limited to 40°C max. (ambient temperature 85°C). When rated current is applied to the products, the self-temperature rise shall be limited to 20°C max. (ambient temperature 85-105°C).

Continued on the following page. ↗



Continued from the preceding page. ↘

Part Number		Inductance	Inductance Test Frequency	Rated Current (Isat)*	Rated Current (Itemp)*	DC Resistance	S.R.F* (min.)
Infotainment	Powertrain/Safety						
LQH2MPZ680MGR□	—	68μH ±20%	1MHz	230mA	160mA(Ambient temp.85°C) 100mA(Ambient temp.105°C)	6.7Ω±20%	7MHz
LQH2MPZ820MGR□	—	82μH ±20%	1MHz	210mA	150mA(Ambient temp.85°C) 90mA(Ambient temp.105°C)	7.3Ω±20%	5MHz

Operating temp.range (Self-temp.rise included): -40 to 125°C  
 Operating temp.range (Self-temp.rise not included): -40 to 105°C  
 Class of Magnetic Shield: Ferrite Core

Only for reflow soldering

\*Isat: Rated Current based on Inductance change

\*Itemp: Rated Current based on Temperature rise

\*S.R.F: Self Resonant Frequency

When rated current is applied to the products, inductance will be within ±30% of initial inductance value range. Keep the temperature (ambient temperature plus self-generation of heat) under 125°C. When rated current is applied to the products, the self-temperature rise shall be limited to 40°C max. (ambient temperature 85°C). When rated current is applied to the products, the self-temperature rise shall be limited to 20°C max. (ambient temperature 85-105°C).

**Inductance-Frequency Characteristics (Typ.)**

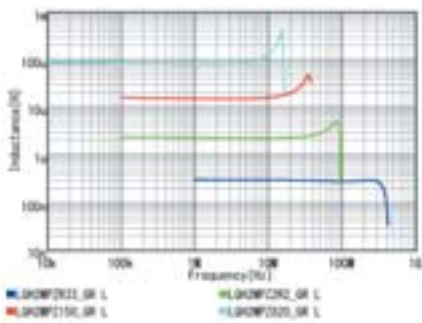

**Inductance-Current Characteristics (Typ.)**

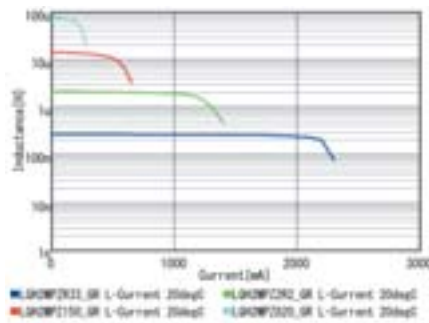

**Temperature Rise Characteristics (Typ.)**

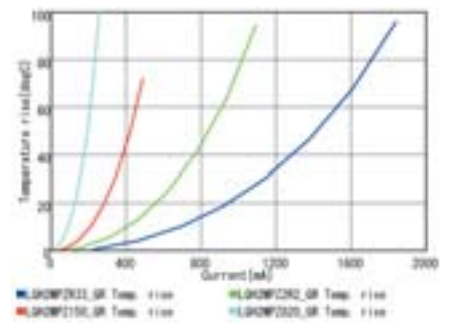

## Inductors for Power Lines

# LQH2HPZ\_DR Series 1008 (2520) inch (mm)

### Appearance/Dimensions

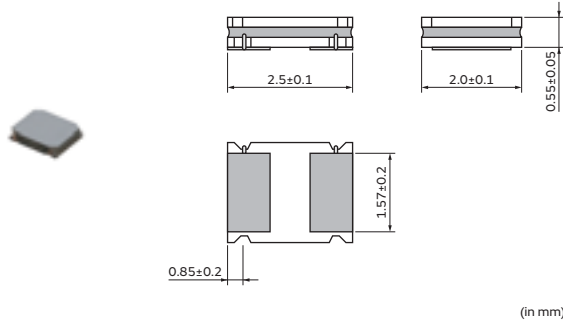

### Packaging

Code	Packaging	Minimum Quantity
L	ø180mm Embossed Taping	4000

### Rated Value (□: packaging code)

Part Number		Inductance	Inductance Test Frequency	Rated Current (Isat)*	Rated Current (Itemp)*	DC Resistance	S.R.F* (min.)
Infotainment	Powertrain/Safety						
LQH2HPZR47MDR□	—	0.47μH ±20%	1MHz	1670mA	1250mA(Ambient temp.85°C) 750mA(Ambient temp.105°C)	0.14Ω±20%	120MHz
LQH2HPZ1R0MDR□	—	1.0μH ±20%	1MHz	1370mA	960mA(Ambient temp.85°C) 580mA(Ambient temp.105°C)	0.24Ω±20%	100MHz
LQH2HPZ1R5MDR□	—	1.5μH ±20%	1MHz	1120mA	900mA(Ambient temp.85°C) 540mA(Ambient temp.105°C)	0.29Ω±20%	60MHz
LQH2HPZ2R2MDR□	—	2.2μH ±20%	1MHz	850mA	820mA(Ambient temp.85°C) 500mA(Ambient temp.105°C)	0.34Ω±20%	50MHz
LQH2HPZ3R3MDR□	—	3.3μH ±20%	1MHz	750mA	730mA(Ambient temp.85°C) 440mA(Ambient temp.105°C)	0.45Ω±20%	45MHz
LQH2HPZ4R7MDR□	—	4.7μH ±20%	1MHz	650mA	650mA(Ambient temp.85°C) 390mA(Ambient temp.105°C)	0.56Ω±20%	40MHz
LQH2HPZ6R8MDR□	—	6.8μH ±20%	1MHz	550mA	490mA(Ambient temp.85°C) 300mA(Ambient temp.105°C)	1.0Ω±20%	35MHz
LQH2HPZ100MDR□	—	10μH ±20%	1MHz	420mA	430mA(Ambient temp.85°C) 260mA(Ambient temp.105°C)	1.2Ω±20%	30MHz
LQH2HPZ150MDR□	—	15μH ±20%	1MHz	340mA	290mA(Ambient temp.85°C) 180mA(Ambient temp.105°C)	2.5Ω±20%	25MHz
LQH2HPZ220MDR□	—	22μH ±20%	1MHz	260mA	270mA(Ambient temp.85°C) 170mA(Ambient temp.105°C)	3.0Ω±20%	20MHz

Operating temp.range (Self-temp.rise included): -40 to 125°C  
 Operating temp.range (Self-temp.rise not included): -40 to 105°C  
 Class of Magnetic Shield: Magnetic Resin

Only for reflow soldering

\*Isat: Rated Current based on Inductance change

\*Itemp: Rated Current based on Temperature rise

\*S.R.F: Self Resonant Frequency

When rated current is applied to the products, inductance will be within ±30% of initial inductance value range. Keep the temperature (ambient temperature plus self-generation of heat) under 125°C. When rated current is applied to the products, the self-temperature rise shall be limited to 40°C max. (ambient temperature 85°C). When rated current is applied to the products, the self-temperature rise shall be limited to 20°C max. (ambient temperature 85-105°C).

Continued on the following page. ↗

Continued from the preceding page. ↘

**Inductance-Frequency Characteristics (Typ.)**

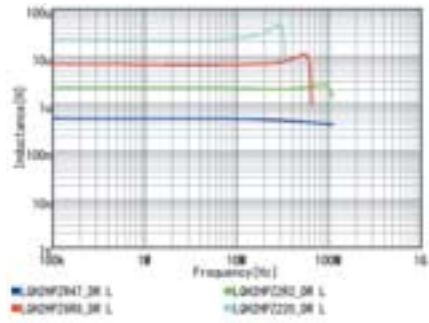

**Inductance-Current Characteristics (Typ.)**

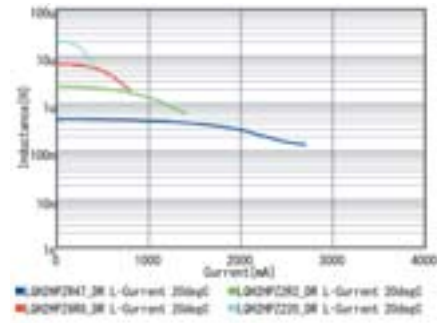

**Temperature Rise Characteristics (Typ.)**

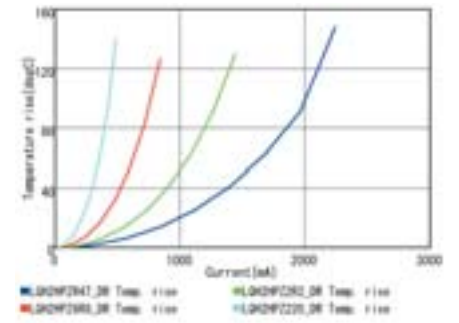

Inductors for Power Lines  
 Inductors for General Circuits  
 RF Inductors

## Inductors for Power Lines

# LQH2HPZ\_GR Series 1008 (2520) inch (mm)

### Appearance/Dimensions

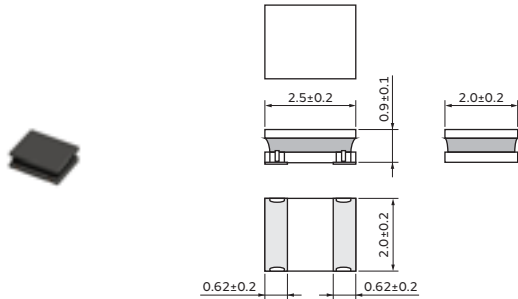

(in mm)

### Packaging

Code	Packaging	Minimum Quantity
L	ø180mm Embossed Taping	3000

### Rated Value (□: packaging code)

Part Number		Inductance	Inductance Test Frequency	Rated Current (Isat)*	Rated Current (Itemp)*	DC Resistance	S.R.F.* (min.)
Infotainment	Powertrain/Safety						
LQH2HPZR47MGR□	—	0.47µH ±20%	1MHz	2900mA	2520mA(Ambient temp.85°C) 1470mA(Ambient temp.105°C)	0.045Ω±20%	120MHz
LQH2HPZR68MGR□	—	0.68µH ±20%	1MHz	2430mA	2330mA(Ambient temp.85°C) 1350mA(Ambient temp.105°C)	0.055Ω±20%	110MHz
LQH2HPZ1R0MGR□	—	1.0µH ±20%	1MHz	2130mA	2100mA(Ambient temp.85°C) 1200mA(Ambient temp.105°C)	0.068Ω±20%	100MHz
LQH2HPZ1R5MGR□	—	1.5µH ±20%	1MHz	1700mA	1850mA(Ambient temp.85°C) 1110mA(Ambient temp.105°C)	0.087Ω±20%	90MHz
LQH2HPZ2R2MGR□	—	2.2µH ±20%	1MHz	1550mA	1470mA(Ambient temp.85°C) 850mA(Ambient temp.105°C)	0.134Ω±20%	80MHz
LQH2HPZ3R3MGR□	—	3.3µH ±20%	1MHz	1230mA	1100mA(Ambient temp.85°C) 660mA(Ambient temp.105°C)	0.225Ω±20%	70MHz
LQH2HPZ4R7MGR□	—	4.7µH ±20%	1MHz	1090mA	1000mA(Ambient temp.85°C) 570mA(Ambient temp.105°C)	0.300Ω±20%	50MHz
LQH2HPZ6R8MGR□	—	6.8µH ±20%	1MHz	830mA	860mA(Ambient temp.85°C) 490mA(Ambient temp.105°C)	0.395Ω±20%	40MHz
LQH2HPZ100MGR□	—	10µH ±20%	1MHz	700mA	710mA(Ambient temp.85°C) 430mA(Ambient temp.105°C)	0.560Ω±20%	30MHz
LQH2HPZ150MGR□	—	15µH ±20%	1MHz	570mA	560mA(Ambient temp.85°C) 310mA(Ambient temp.105°C)	0.925Ω±20%	20MHz
LQH2HPZ220MGR□	—	22µH ±20%	1MHz	460mA	430mA(Ambient temp.85°C) 250mA(Ambient temp.105°C)	1.360Ω±20%	15MHz

Operating temp.range (Self-temp.rise included): -40 to 125°C

Operating temp.range (Self-temp.rise not included): -40 to 105°C

Class of Magnetic Shield: Magnetic Resin

Only for reflow soldering

\*Isat: Rated Current based on Inductance change

\*Itemp: Rated Current based on Temperature rise

\*S.R.F: Self Resonant Frequency

When rated current is applied to the products, inductance will be within ±30% of initial inductance value range. Keep the temperature (ambient temperature plus self-generation of heat) under 125°C. When rated current is applied to the products, the self-temperature rise shall be limited to 40°C max. (ambient temperature 85°C). When rated current is applied to the products, the self-temperature rise shall be limited to 20°Cmax. (ambient temperature 85 to 105°C).

Continued on the following page. ↗

Continued from the preceding page. ↘

**Inductance-Frequency Characteristics (Typ.)**

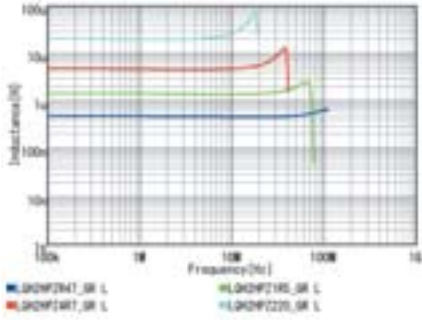

**Inductance-Current Characteristics (Typ.)**

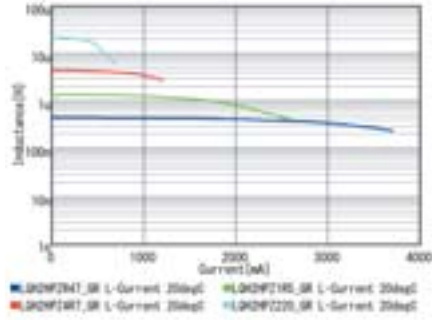

**Temperature Rise Characteristics (Typ.)**

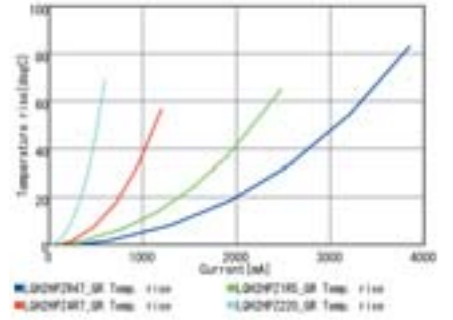

## Inductors for Power Lines

# LQH2HPZ\_JR Series 1008 (2520) inch (mm)

### Appearance/Dimensions

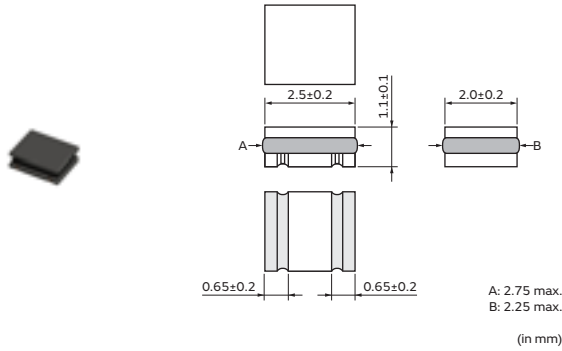

### Packaging

Code	Packaging	Minimum Quantity
L	ø180mm Embossed Taping	2000

### Rated Value (□: packaging code)

Part Number		Inductance	Inductance Test Frequency	Rated Current (Isat)*	Rated Current (Itemp)*	DC Resistance	S.R.F.* (min.)
Infotainment	Powertrain/Safety						
LQH2HPZR47NJR□	—	0.47μH ±30%	1MHz	3500mA	2750mA(Ambient temp.85°C) 1650mA(Ambient temp.105°C)	0.031Ω±20%	190MHz
LQH2HPZ1R0NJR□	—	1.0μH ±30%	1MHz	2600mA	2400mA(Ambient temp.85°C) 1440mA(Ambient temp.105°C)	0.048Ω±20%	120MHz
LQH2HPZ1R2NJR□	—	1.2μH ±30%	1MHz	2450mA	2070mA(Ambient temp.85°C) 1240mA(Ambient temp.105°C)	0.055Ω±20%	100MHz
LQH2HPZ1R5NJR□	—	1.5μH ±30%	1MHz	2200mA	1810mA(Ambient temp.85°C) 1080mA(Ambient temp.105°C)	0.075Ω±20%	95MHz
LQH2HPZ2R2MJR□	—	2.2μH ±20%	1MHz	1700mA	1650mA(Ambient temp.85°C) 990mA(Ambient temp.105°C)	0.092Ω±20%	50MHz
LQH2HPZ3R3MJR□	—	3.3μH ±20%	1MHz	1450mA	1420mA(Ambient temp.85°C) 850mA(Ambient temp.105°C)	0.13Ω±20%	45MHz
LQH2HPZ4R7MJR□	—	4.7μH ±20%	1MHz	1230mA	1290mA(Ambient temp.85°C) 770mA(Ambient temp.105°C)	0.17Ω±20%	40MHz
LQH2HPZ6R8MJR□	—	6.8μH ±20%	1MHz	1050mA	1000mA(Ambient temp.85°C) 600mA(Ambient temp.105°C)	0.26Ω±20%	35MHz
LQH2HPZ100MJR□	—	10μH ±20%	1MHz	830mA	830mA(Ambient temp.85°C) 490mA(Ambient temp.105°C)	0.38Ω±20%	30MHz
LQH2HPZ150MJR□	—	15μH ±20%	1MHz	690mA	710mA(Ambient temp.85°C) 420mA(Ambient temp.105°C)	0.55Ω±20%	20MHz
LQH2HPZ220MJR□	—	22μH ±20%	1MHz	530mA	540mA(Ambient temp.85°C) 320mA(Ambient temp.105°C)	0.84Ω±20%	20MHz

Operating temp.range (Self-temp.rise included): -40 to 125°C

Operating temp.range (Self-temp.rise not included): -40 to 105°C

Class of Magnetic Shield: Magnetic Resin

Only for reflow soldering

\*Isat: Rated Current based on Inductance change

\*Itemp: Rated Current based on Temperature rise

\*S.R.F: Self Resonant Frequency

When rated current is applied to the products, inductance will be within ±30% of initial inductance value range. Keep the temperature (ambient temperature plus self-generation of heat) under 125°C. When rated current is applied to the products, the self-temperature rise shall be limited to 40°C max. (ambient temperature 85°C). When rated current is applied to the products, the self-temperature rise shall be limited to 20°C max. (ambient temperature 85-105°C).

Continued on the following page. ↗

Continued from the preceding page. ↘

**Inductance-Frequency Characteristics (Typ.)**

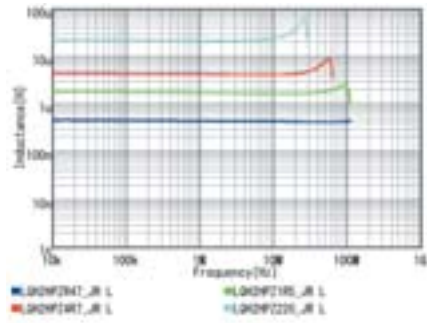

**Inductance-Current Characteristics (Typ.)**

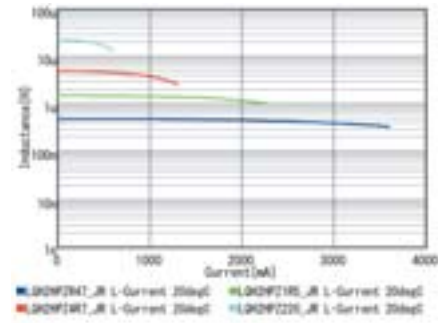

**Temperature Rise Characteristics (Typ.)**

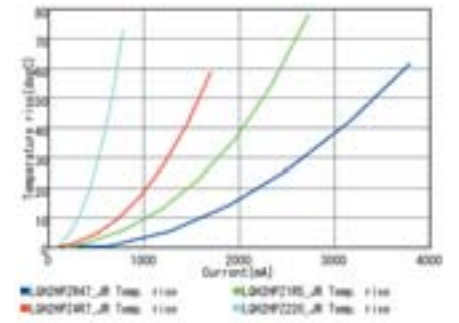

Inductors for Power Lines  
 Inductors for General Circuits  
 RF Inductors

## Inductors for Power Lines

# LQH32CH\_23 Series 1210 (3225) inch (mm)

### Appearance/Dimensions

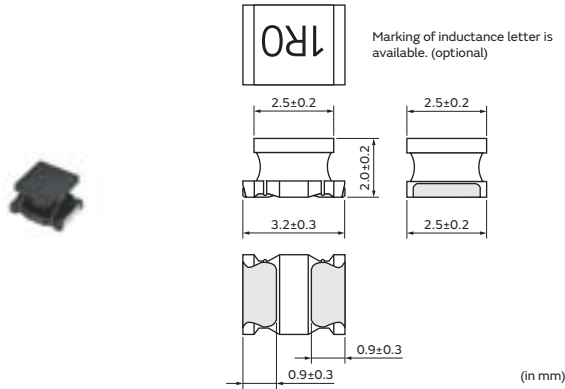

### Packaging

Code	Packaging	Minimum Quantity
K	ø330mm Embossed Taping	7500
L	ø180mm Embossed Taping	2000
B	Packing in Bulk	500

### Rated Value (□: packaging code)

Part Number		Inductance	Inductance Test Frequency	Rated Current	DC Resistance	S.R.F* (min.)
Infotainment	Powertrain/Safety					
—	LQH32CH1R0M23□	1.0μH ±20%	1MHz	800mA	0.09Ω±30%	96MHz
—	LQH32CH2R2M23□	2.2μH ±20%	1MHz	600mA	0.13Ω±30%	64MHz
—	LQH32CH4R7M23□	4.7μH ±20%	1MHz	450mA	0.20Ω±30%	43MHz
—	LQH32CH100K23□	10μH ±10%	1MHz	300mA	0.44Ω±30%	26MHz
—	LQH32CH220K23□	22μH ±10%	1MHz	250mA	0.71Ω±30%	19MHz

Operating temp.range (Self-temp.rise not included): -40 to 85°C

Class of Magnetic Shield: No Shield

\*S.R.F: Self Resonant Frequency

When rated current is applied to the products, self-temperature rise shall be limited to 20°C max and inductance will be within ±10% of initial inductance value.

### Inductance-Frequency Characteristics (Typ.)

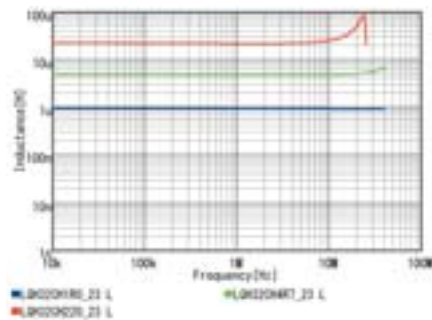

### Inductance-Current Characteristics (Typ.)

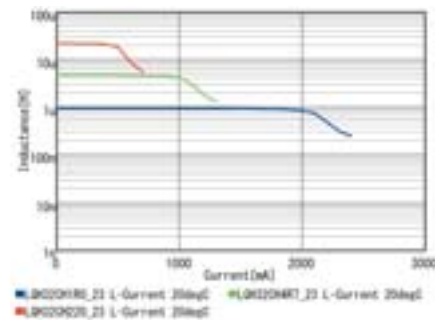

### Impedance-Frequency Characteristics (Typ.)

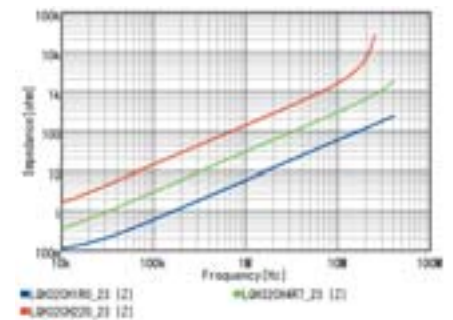



# Inductors for Power Lines

## LQH32CH\_33 Series 1210 (3225) inch (mm)

### Appearance/Dimensions

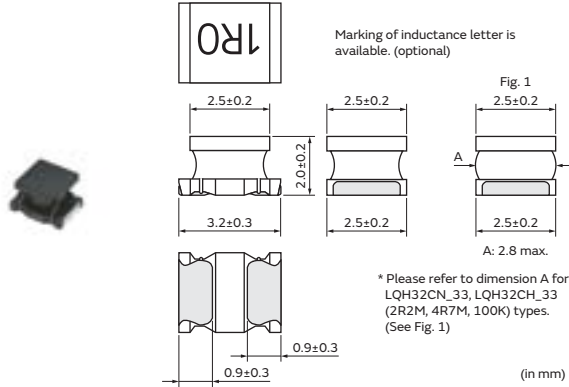

### Packaging

Code	Packaging	Minimum Quantity
K	ø330mm Embossed Taping	7500
L	ø180mm Embossed Taping	2000
B	Packing in Bulk	500

### Rated Value (□: packaging code)

Part Number		Inductance	Inductance Test Frequency	Rated Current	DC Resistance	S.R.F* (min.)
Infotainment	Powertrain/Safety					
—	LQH32CHR15M33□	0.15μH ±20%	1MHz	1450mA	0.028Ω±30%	400MHz
—	LQH32CHR27M33□	0.27μH ±20%	1MHz	1250mA	0.034Ω±30%	250MHz
—	LQH32CHR47M33□	0.47μH ±20%	1MHz	1100mA	0.042Ω±30%	150MHz
—	LQH32CH1R0M33□	1.0μH ±20%	1MHz	1000mA	0.060Ω±30%	100MHz
—	LQH32CH2R2M33□	2.2μH ±20%	1MHz	790mA	0.097Ω±30%	64MHz
—	LQH32CH4R7M33□	4.7μH ±20%	1MHz	650mA	0.15Ω±30%	43MHz
—	LQH32CH100K33□	10μH ±10%	1MHz	450mA	0.30Ω±30%	26MHz

Operating temp.range (Self-temp.rise not included): -40 to 85°C

Class of Magnetic Shield: No Shield

\*S.R.F: Self Resonant Frequency

When rated current is applied to the products, self-temperature rise shall be limited to 20°C max and inductance will be within ±10% of initial inductance value.

### Inductance-Frequency Characteristics (Typ.)

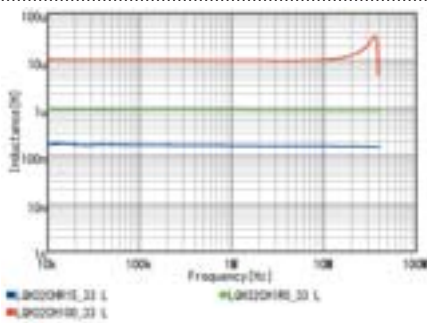

### Inductance-Current Characteristics (Typ.)

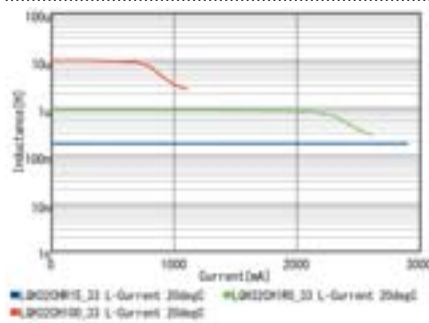

### Impedance-Frequency Characteristics (Typ.)

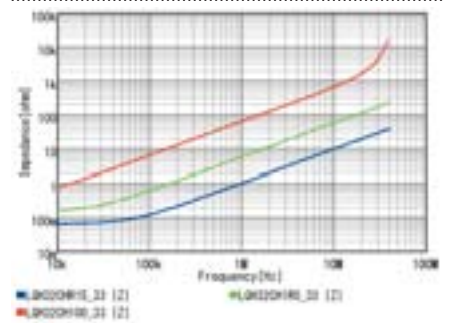

## Inductors for Power Lines

# LQH32CH\_53 Series 1210 (3225) inch (mm)

### Appearance/Dimensions

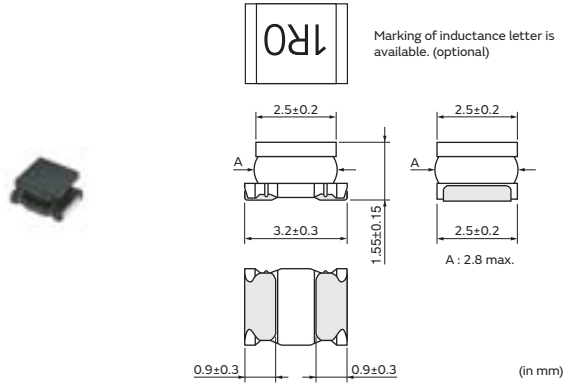

### Packaging

Code	Packaging	Minimum Quantity
K	ø330mm Embossed Taping	7500
L	ø180mm Embossed Taping	2000
B	Packing in Bulk	500

### Rated Value (□: packaging code)

Part Number		Inductance	Inductance Test Frequency	Rated Current	DC Resistance	S.R.F* (min.)
Infotainment	Powertrain/Safety					
—	LQH32CH1R0M53□	1.0μH ±20%	1MHz	1000mA	0.060Ω±30%	100MHz
—	LQH32CH2R2M53□	2.2μH ±20%	1MHz	790mA	0.097Ω±30%	64MHz
—	LQH32CH3R3M53□	3.3μH ±20%	1MHz	710mA	0.12Ω±30%	50MHz
—	LQH32CH4R7M53□	4.7μH ±20%	1MHz	650mA	0.15Ω±30%	43MHz
—	LQH32CH6R8M53□	6.8μH ±20%	1MHz	540mA	0.25Ω±30%	32MHz
—	LQH32CH100K53□	10μH ±10%	1MHz	450mA	0.30Ω±30%	26MHz
—	LQH32CH150K53□	15μH ±10%	1MHz	300mA	0.58Ω±30%	26MHz
—	LQH32CH220K53□	22μH ±10%	1MHz	250mA	0.71Ω±30%	19MHz

Operating temp.range (Self-temp.rise not included): -40 to 85°C

Class of Magnetic Shield: No Shield

\*S.R.F: Self Resonant Frequency

When rated current is applied to the products, self-temperature rise shall be limited to 20°C max and inductance will be within ±10% of initial inductance value.

### Inductance-Frequency Characteristics (Typ.)

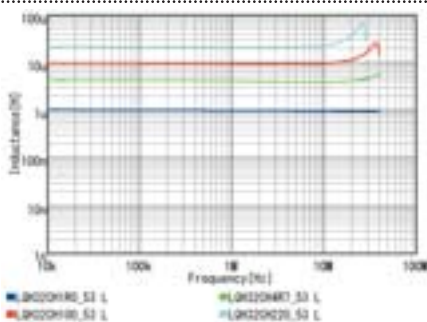

### Inductance-Current Characteristics (Typ.)

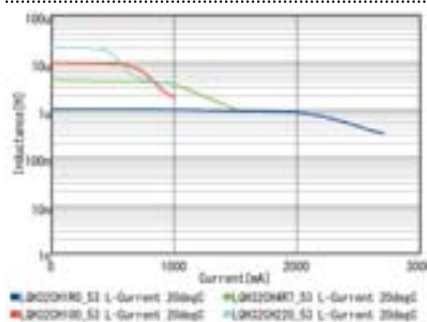

### Impedance-Frequency Characteristics (Typ.)

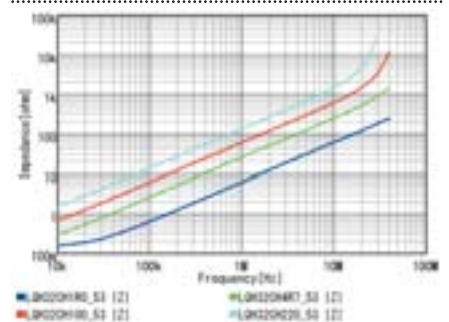

# Inductors for Power Lines

## LQH32DZ\_23 Series 1210 (3225) inch (mm)

### Appearance/Dimensions

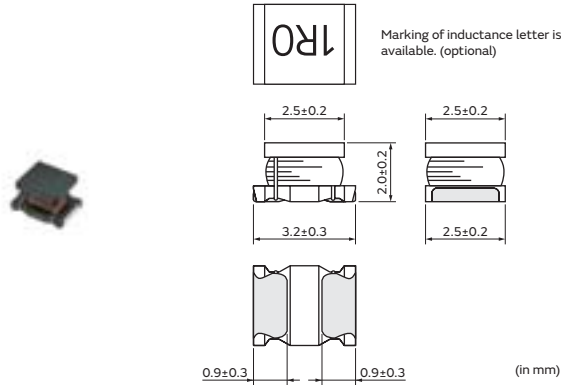

### Packaging

Code	Packaging	Minimum Quantity
K	ø330mm Embossed Taping	7500
L	ø180mm Embossed Taping	2000

### Rated Value (□: packaging code)

Part Number		Inductance	Inductance Test Frequency	Rated Current	DC Resistance	S.R.F* (min.)
Infotainment	Powertrain/Safety					
LQH32DZ1R0M23□	—	1.0μH ±20%	1MHz	800mA	0.09Ω±30%	96MHz
LQH32DZ2R2M23□	—	2.2μH ±20%	1MHz	600mA	0.13Ω±30%	64MHz
LQH32DZ3R3M23□	—	3.3μH ±20%	1MHz	530mA	0.20Ω±30%	50MHz
LQH32DZ4R7M23□	—	4.7μH ±20%	1MHz	450mA	0.20Ω±30%	43MHz
LQH32DZ100K23□	—	10μH ±10%	1MHz	300mA	0.44Ω±30%	26MHz
LQH32DZ220K23□	—	22μH ±10%	1MHz	250mA	0.71Ω±30%	19MHz
LQH32DZ390K23□	—	39μH ±10%	1MHz	200mA	1.2Ω±30%	16MHz
LQH32DZ470K23□	—	47μH ±10%	1MHz	170mA	1.3Ω±30%	15MHz
LQH32DZ680K23□	—	68μH ±10%	1MHz	130mA	2.2Ω±30%	12MHz
LQH32DZ101K23□	—	100μH ±10%	1MHz	100mA	3.5Ω±30%	10MHz
LQH32DZ151K23□	—	150μH ±10%	1MHz	80mA	5.1Ω±30%	8.0MHz
LQH32DZ221K23□	—	220μH ±10%	1MHz	70mA	8.4Ω±30%	6.8MHz
LQH32DZ331K23□	—	330μH ±10%	1MHz	60mA	10.0Ω±30%	5.6MHz
LQH32DZ391K23□	—	390μH ±10%	1MHz	60mA	12.4Ω±30%	5MHz
LQH32DZ471K23□	—	470μH ±10%	1kHz	60mA	14.1Ω±30%	5MHz

Operating temp.range: -40 to 105°C

Class of Magnetic Shield: No Shield

Only for reflow soldering

\*S.R.F: Self Resonant Frequency

When rated current is applied to the products, self-temperature rise shall be limited to 20°C max and inductance will be within ±10% of initial inductance value.

### Inductance-Frequency Characteristics (Typ.)

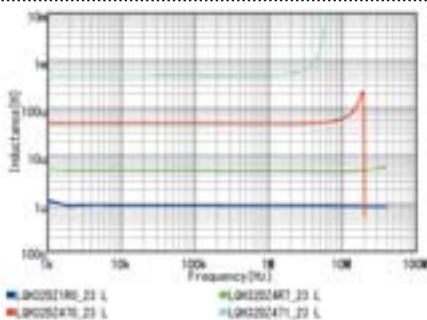

### Inductance-Current Characteristics (Typ.)

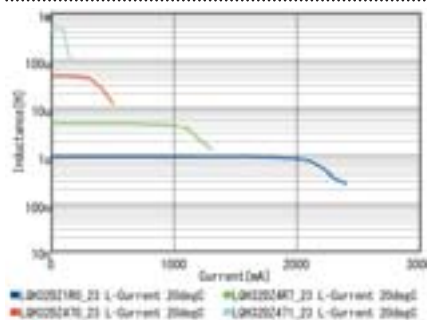

### Impedance-Frequency Characteristics (Typ.)

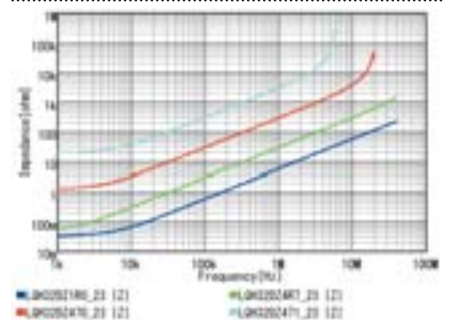

## Inductors for Power Lines

# LQH32DZ\_53 Series 1210 (3225) inch (mm)

### Appearance/Dimensions

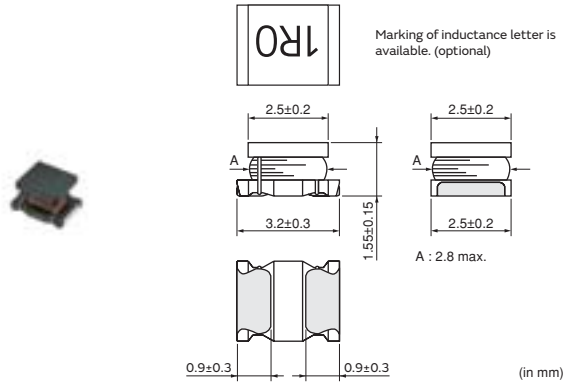

### Packaging

Code	Packaging	Minimum Quantity
K	ø330mm Embossed Taping	7500
L	ø180mm Embossed Taping	2000

### Rated Value (□: packaging code)

Part Number		Inductance	Inductance Test Frequency	Rated Current	DC Resistance	S.R.F* (min.)
Infotainment	Powertrain/Safety					
LQH32DZ1R0M53□	—	1.0μH ±20%	1MHz	1000mA	0.060Ω±30%	100MHz
LQH32DZ2R2M53□	—	2.2μH ±20%	1MHz	790mA	0.097Ω±30%	64MHz
LQH32DZ3R3M53□	—	3.3μH ±20%	1MHz	710mA	0.12Ω±30%	50MHz
LQH32DZ4R7M53□	—	4.7μH ±20%	1MHz	650mA	0.15Ω±30%	43MHz
LQH32DZ6R8M53□	—	6.8μH ±20%	1MHz	540mA	0.25Ω±30%	32MHz
LQH32DZ100K53□	—	10μH ±10%	1MHz	450mA	0.30Ω±30%	26MHz
LQH32DZ150K53□	—	15μH ±10%	1MHz	300mA	0.58Ω±30%	26MHz
LQH32DZ220K53□	—	22μH ±10%	1MHz	250mA	0.71Ω±30%	19MHz
LQH32DZ330K53□	—	33μH ±10%	1MHz	200mA	1.1Ω±30%	17MHz
LQH32DZ470K53□	—	47μH ±10%	1MHz	170mA	1.3Ω±30%	15MHz
LQH32DZ680K53□	—	68μH ±10%	1MHz	130mA	2.2Ω±30%	12MHz
LQH32DZ101K53□	—	100μH ±10%	1MHz	100mA	3.5Ω±30%	10MHz

Operating temp.range: -40 to 105°C

Class of Magnetic Shield: No Shield

Only for reflow soldering

\*S.R.F: Self Resonant Frequency

When rated current is applied to the products, self-temperature rise shall be limited to 20°C max and inductance will be within ±10% of initial inductance value.

### Inductance-Frequency Characteristics (Typ.)

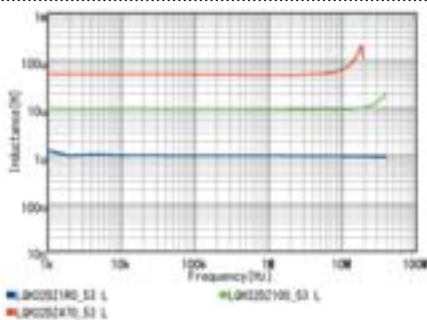

### Inductance-Current Characteristics (Typ.)

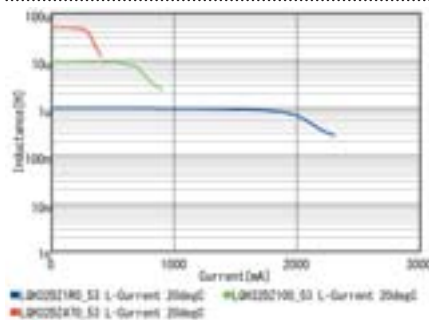

### Impedance-Frequency Characteristics (Typ.)

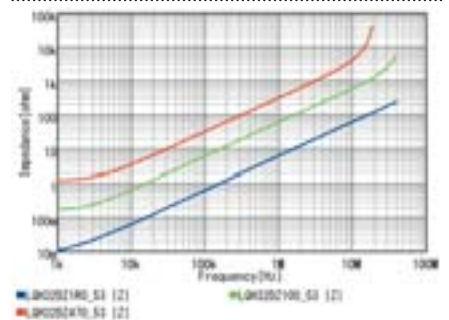

## Inductors for Power Lines

# LQH32PZ\_N0/LQH32PH\_N0 Series 1210 (3225) inch (mm)

### Appearance/Dimensions

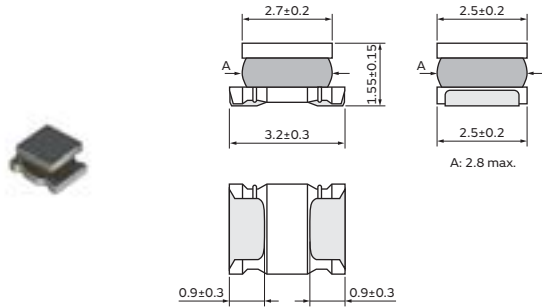

(in mm)

### Packaging

Code	Packaging	Minimum Quantity
K	ø330mm Embossed Taping	7500
L	ø180mm Embossed Taping	2000

### Rated Value (□: packaging code)

Part Number		Inductance	Inductance Test Frequency	Rated Current (I <sub>sat</sub> )*	Rated Current (I <sub>temp</sub> )*	DC Resistance	S.R.F.* (min.)
Infotainment	Powertrain/Safety						
LQH32PZR47NNO□	LQH32PHR47NNO□	0.47μH ±30%	1MHz	3400mA	2550mA(Ambient temp.85°C) 1600mA(Ambient temp.105°C)	0.030Ω±20%	100MHz
LQH32PZ1R0NNO□	LQH32PH1R0NNO□	1.0μH ±30%	1MHz	2300mA	2050mA(Ambient temp.85°C) 1320mA(Ambient temp.105°C)	0.045Ω±20%	100MHz
LQH32PZ1R5NNO□	LQH32PH1R5NNO□	1.5μH ±30%	1MHz	1750mA	1750mA(Ambient temp.85°C) 1010mA(Ambient temp.105°C)	0.057Ω±20%	70MHz
LQH32PZ2R2NNO□	LQH32PH2R2NNO□	2.2μH ±30%	1MHz	1550mA	1600mA(Ambient temp.85°C) 970mA(Ambient temp.105°C)	0.076Ω±20%	70MHz
LQH32PZ3R3NNO□	LQH32PH3R3NNO□	3.3μH ±30%	1MHz	1250mA	1200mA(Ambient temp.85°C) 670mA(Ambient temp.105°C)	0.12Ω±20%	50MHz
LQH32PZ4R7NNO□	LQH32PH4R7NNO□	4.7μH ±30%	1MHz	1000mA	1000mA(Ambient temp.85°C) 530mA(Ambient temp.105°C)	0.18Ω±20%	40MHz
LQH32PZ6R8NNO□	LQH32PH6R8NNO□	6.8μH ±30%	1MHz	850mA	850mA(Ambient temp.85°C) 510mA(Ambient temp.105°C)	0.24Ω±20%	40MHz
LQH32PZ100MN0□	LQH32PH100MN0□	10μH ±20%	1MHz	750mA	700mA(Ambient temp.85°C) 380mA(Ambient temp.105°C)	0.38Ω±20%	30MHz
LQH32PZ150MN0□	—	15μH ±20%	1MHz	600mA	520mA(Ambient temp.85°C) 320mA(Ambient temp.105°C)	0.57Ω±20%	20MHz
LQH32PZ220MN0□	—	22μH ±20%	1MHz	500mA	450mA(Ambient temp.85°C) 240mA(Ambient temp.105°C)	0.81Ω±20%	20MHz
LQH32PZ330MN0□	—	33μH ±20%	1MHz	380mA	390mA(Ambient temp.85°C) 190mA(Ambient temp.105°C)	1.15Ω±20%	13MHz
LQH32PZ470MN0□	—	47μH ±20%	1MHz	330mA	310mA(Ambient temp.85°C) 140mA(Ambient temp.105°C)	1.78Ω±20%	11MHz
LQH32PZ680MN0□	—	68μH ±20%	1MHz	280mA	275mA(Ambient temp.85°C) 120mA(Ambient temp.105°C)	2.28Ω±20%	11MHz
LQH32PZ101MN0□	—	100μH ±20%	1MHz	180mA	250mA(Ambient temp.85°C) 110mA(Ambient temp.105°C)	2.70Ω±20%	8MHz

Operating temp.range (Self-temp.rise included): -40 to 125°C

Operating temp.range (Self-temp.rise not included): -40 to 105°C

Class of Magnetic Shield: Magnetic Resin

Only for reflow soldering

\*I<sub>sat</sub>: Rated Current based on Inductance change

\*I<sub>temp</sub>: Rated Current based on Temperature rise

\*S.R.F.: Self Resonant Frequency

When rated current is applied to the products, inductance will be within ±30% of nominal inductance value. When rated current is applied to the products, the temperature rise caused by self-generated heat shall be limited to 40°C max. Keep the temperature (ambient temperature plus self-generation of heat) under 125°C.

Continued on the following page. ↗

Continued from the preceding page. ↘

Part Number		Inductance	Inductance Test Frequency	Rated Current (Isat)*	Rated Current (Itemp)*	DC Resistance	S.R.F* (min.)
Infotainment	Powertrain/Safety						
LQH32PZ121MNO□	—	120μH ±20%	1MHz	170mA	200mA(Ambient temp.85°C) 80mA(Ambient temp.105°C)	4.38Ω±20%	8MHz

Operating temp.range (Self-temp.rise included): -40 to 125°C  
 Operating temp.range (Self-temp.rise not included): -40 to 105°C  
 Class of Magnetic Shield: Magnetic Resin

Only for reflow soldering

\*Isat: Rated Current based on Inductance change

\*Itemp: Rated Current based on Temperature rise

\*S.R.F: Self Resonant Frequency

When rated current is applied to the products, inductance will be within ±30% of nominal inductance value. When rated current is applied to the products, the temperature rise caused by self-generated heat shall be limited to 40°C max. Keep the temperature (ambient temperature plus self-generation of heat) under 125°C.

### Inductance-Frequency Characteristics (Typ.)

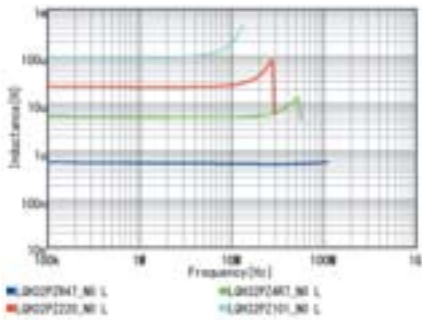

### Inductance-Current Characteristics (Typ.)

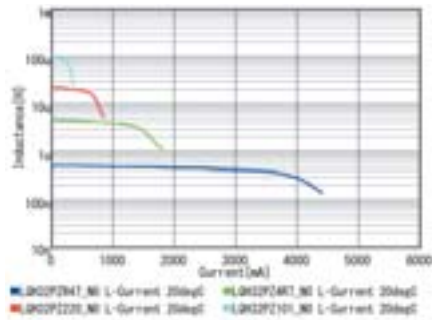

### Temperature Rise Characteristics (Typ.)

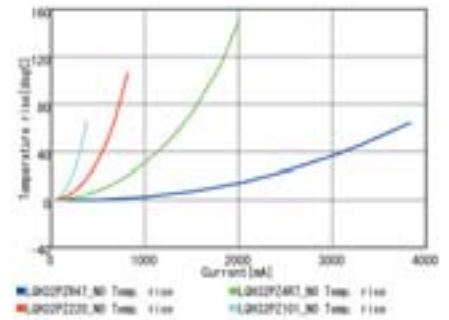

## Inductors for Power Lines

# LQH32PZ\_NC/LQH32PH\_NC Series 1210 (3225) inch (mm)

### Appearance/Dimensions

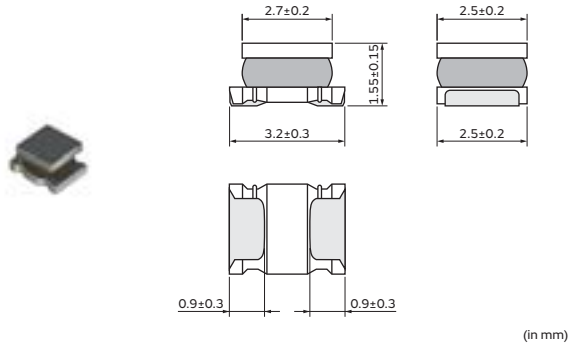

### Packaging

Code	Packaging	Minimum Quantity
K	ø330mm Embossed Taping	7500
L	ø180mm Embossed Taping	2000

### Rated Value (□: packaging code)

Part Number		Inductance	Inductance Test Frequency	Rated Current (Isat)*	Rated Current (Itemp)*	DC Resistance	S.R.F* (min.)
Infotainment	Powertrain/Safety						
LQH32PZR47NNC□	LQH32PHR47NNC□	0.47µH ±30%	1MHz	4400mA	2900mA(Ambient temp.85°C) 1490mA(Ambient temp.105°C)	0.024Ω±20%	100MHz
LQH32PZ1R0NNC□	LQH32PH1R0NNC□	1.0µH ±30%	1MHz	3000mA	2500mA(Ambient temp.85°C) 1380mA(Ambient temp.105°C)	0.036Ω±20%	100MHz
LQH32PZ1R5NNC□	LQH32PH1R5NNC□	1.5µH ±30%	1MHz	2600mA	2100mA(Ambient temp.85°C) 1110mA(Ambient temp.105°C)	0.053Ω±20%	70MHz
LQH32PZ2R2NNC□	LQH32PH2R2NNC□	2.2µH ±30%	1MHz	2000mA	1850mA(Ambient temp.85°C) 910mA(Ambient temp.105°C)	0.064Ω±20%	70MHz
LQH32PZ3R3NNC□	LQH32PH3R3NNC□	3.3µH ±30%	1MHz	1900mA	1550mA(Ambient temp.85°C) 800mA(Ambient temp.105°C)	0.100Ω±20%	50MHz
LQH32PZ4R7NNC□	LQH32PH4R7NNC□	4.7µH ±30%	1MHz	1600mA	1200mA(Ambient temp.85°C) 610mA(Ambient temp.105°C)	0.155Ω±20%	40MHz
LQH32PZ6R8NNC□	LQH32PH6R8NNC□	6.8µH ±30%	1MHz	1300mA	1100mA(Ambient temp.85°C) 550mA(Ambient temp.105°C)	0.220Ω±20%	40MHz
LQH32PZ100MNC□	LQH32PH100MNC□	10µH ±20%	1MHz	1000mA	900mA(Ambient temp.85°C) 450mA(Ambient temp.105°C)	0.295Ω±20%	30MHz
LQH32PZ150MNC□	LQH32PH150MNC□	15µH ±20%	1MHz	800mA	700mA(Ambient temp.85°C) 330mA(Ambient temp.105°C)	0.475Ω±20%	20MHz
LQH32PZ220MNC□	LQH32PH220MNC□	22µH ±20%	1MHz	650mA	550mA(Ambient temp.85°C) 270mA(Ambient temp.105°C)	0.685Ω±20%	20MHz

Operating temp.range (Self-temp.rise included): -40 to 125°C  
 Operating temp.range (Self-temp.rise not included): -40 to 105°C  
 Class of Magnetic Shield: Magnetic Resin

Only for reflow soldering

\*Isat: Rated Current based on Inductance change

\*Itemp: Rated Current based on Temperature rise

\*S.R.F: Self Resonant Frequency

When rated current is applied to the products, inductance will be within ±30% of nominal inductance value. When rated current is applied to the products, the temperature rise caused by self-generated heat shall be limited to 40°C max. Keep the temperature (ambient temperature plus self-generation of heat) under 125°C.

Continued on the following page. ↗

Continued from the preceding page. ↘

**Inductance-Frequency Characteristics (Typ.)**

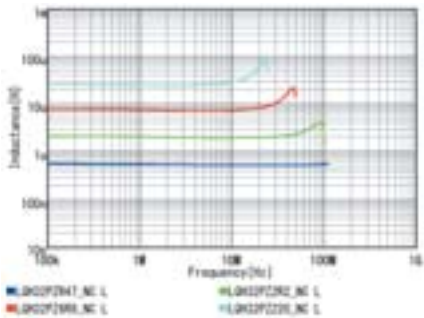

**Inductance-Current Characteristics (Typ.)**

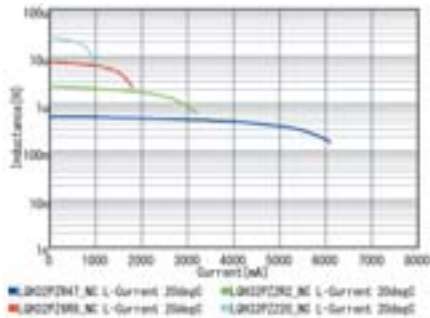

**Temperature Rise Characteristics (Typ.)**

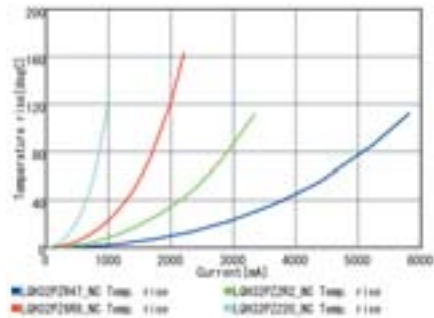

Inductors for Power Lines

Inductors for General Circuits

RF Inductors



## Inductors for Power Lines

# LQH3NPZ\_GR Series 1212 (3030) inch (mm)

### Appearance/Dimensions

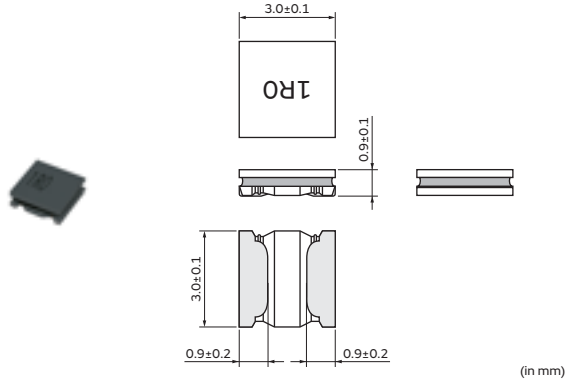

### Packaging

Code	Packaging	Minimum Quantity
L	ø180mm Embossed Taping	3000

### Rated Value (□: packaging code)

Part Number		Inductance	Inductance Test Frequency	Rated Current (Isat)*	Rated Current (Itemp)*	DC Resistance	S.R.F.* (min.)
Infotainment	Powertrain/Safety						
LQH3NPZR47NGR□	—	0.47μH ±30%	1MHz	2820mA	2540mA(Ambient temp.85°C) 1520mA(Ambient temp.105°C)	0.047Ω±20%	180MHz
LQH3NPZ1R0MGR□	—	1.0μH ±20%	1MHz	1700mA	2080mA(Ambient temp.85°C) 1240mA(Ambient temp.105°C)	0.062Ω±20%	100MHz
LQH3NPZ1R5MGR□	—	1.5μH ±20%	1MHz	1400mA	2040mA(Ambient temp.85°C) 1220mA(Ambient temp.105°C)	0.074Ω±20%	80MHz
LQH3NPZ2R2MGR□	—	2.2μH ±20%	1MHz	1180mA	1730mA(Ambient temp.85°C) 1030mA(Ambient temp.105°C)	0.087Ω±20%	50MHz
LQH3NPZ3R3MGR□	—	3.3μH ±20%	1MHz	1050mA	1580mA(Ambient temp.85°C) 940mA(Ambient temp.105°C)	0.12Ω±20%	30MHz
LQH3NPZ4R7MGR□	—	4.7μH ±20%	1MHz	850mA	1520mA(Ambient temp.85°C) 910mA(Ambient temp.105°C)	0.14Ω±20%	27MHz
LQH3NPZ6R8MGR□	—	6.8μH ±20%	1MHz	720mA	1140mA(Ambient temp.85°C) 680mA(Ambient temp.105°C)	0.23Ω±20%	25MHz
LQH3NPZ100MGR□	—	10μH ±20%	1MHz	570mA	1120mA(Ambient temp.85°C) 670mA(Ambient temp.105°C)	0.28Ω±20%	20MHz
LQH3NPZ150MGR□	—	15μH ±20%	1MHz	480mA	900mA(Ambient temp.85°C) 540mA(Ambient temp.105°C)	0.39Ω±20%	15MHz
LQH3NPZ220MGR□	—	22μH ±20%	1MHz	390mA	750mA(Ambient temp.85°C) 450mA(Ambient temp.105°C)	0.53Ω±20%	10MHz
LQH3NPZ330MGR□	—	33μH ±20%	1MHz	320mA	600mA(Ambient temp.85°C) 360mA(Ambient temp.105°C)	0.86Ω±20%	8MHz
LQH3NPZ470MGR□	—	47μH ±20%	1MHz	260mA	460mA(Ambient temp.85°C) 270mA(Ambient temp.105°C)	1.4Ω±20%	5MHz

Operating temp.range (Self-temp.rise included): -40 to 125°C

Operating temp.range (Self-temp.rise not included): -40 to 105°C

Class of Magnetic Shield: Magnetic Resin

Only for reflow soldering

\*Isat: Rated Current based on Inductance change

\*Itemp: Rated Current based on Temperature rise

\*S.R.F: Self Resonant Frequency

When rated current is applied to the products, inductance will be within ±30% of initial inductance value range. Keep the temperature (ambient temperature plus self-generation of heat) under 125°C. When rated current is applied to the products, the self-temperature rise shall be limited to 40°C max. (ambient temperature 85°C). When rated current is applied to the products, the self-temperature rise shall be limited to 20°C max. (ambient temperature 85 to 105°C).

Continued on the following page. ↗

Continued from the preceding page. ↘

**Inductance-Frequency Characteristics (Typ.)**

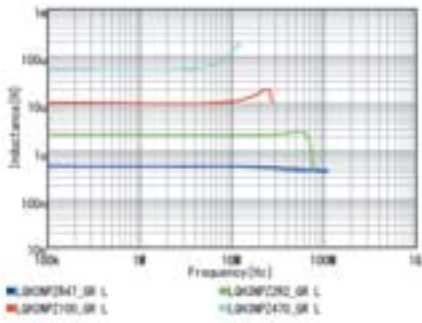

**Inductance-Current Characteristics (Typ.)**

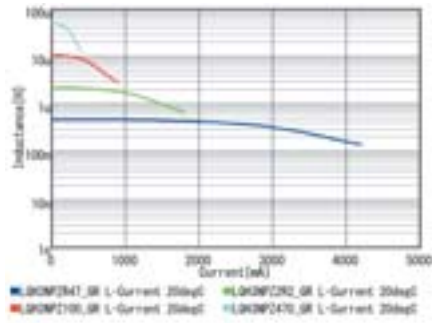

**Temperature Rise Characteristics (Typ.)**

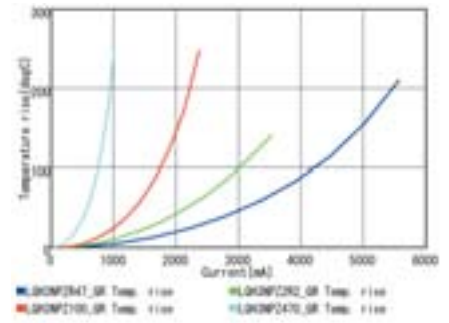

Inductors for Power Lines  
 Inductors for General Circuits  
 RF Inductors

## Inductors for Power Lines

# LQH3NPZ\_JR Series 1212 (3030) inch (mm)

### Appearance/Dimensions

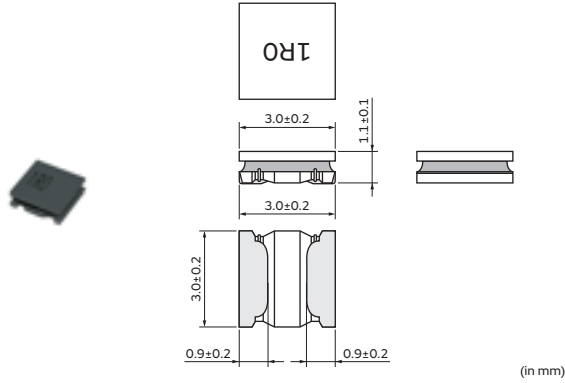

### Packaging

Code	Packaging	Minimum Quantity
L	ø180mm Embossed Taping	2000

### Rated Value (□: packaging code)

Part Number		Inductance	Inductance Test Frequency	Rated Current (Isat)*	Rated Current (Itemp)*	DC Resistance	S.R.F.* (min.)
Infotainment	Powertrain/Safety						
LQH3NPZR68NJR□	—	0.68μH ±30%	1MHz	2700mA	2860mA(Ambient temp.85°C) 1280mA(Ambient temp.105°C)	0.032Ω±20%	130MHz
LQH3NPZ1R0MJR□	—	1.0μH ±20%	1MHz	2250mA	2780mA(Ambient temp.85°C) 1230mA(Ambient temp.105°C)	0.040Ω±20%	100MHz
LQH3NPZ1R5MJR□	—	1.5μH ±20%	1MHz	1950mA	2510mA(Ambient temp.85°C) 1100mA(Ambient temp.105°C)	0.049Ω±20%	60MHz
LQH3NPZ2R2MJR□	—	2.2μH ±20%	1MHz	1800mA	2200mA(Ambient temp.85°C) 980mA(Ambient temp.105°C)	0.068Ω±20%	45MHz
LQH3NPZ3R3MJR□	—	3.3μH ±20%	1MHz	1350mA	1700mA(Ambient temp.85°C) 750mA(Ambient temp.105°C)	0.095Ω±20%	45MHz
LQH3NPZ4R7MJR□	—	4.7μH ±20%	1MHz	1180mA	1580mA(Ambient temp.85°C) 710mA(Ambient temp.105°C)	0.12Ω±20%	40MHz
LQH3NPZ6R8MJR□	—	6.8μH ±20%	1MHz	970mA	1360mA(Ambient temp.85°C) 610mA(Ambient temp.105°C)	0.18Ω±20%	35MHz
LQH3NPZ100MJR□	—	10μH ±20%	1MHz	810mA	1200mA(Ambient temp.85°C) 530mA(Ambient temp.105°C)	0.24Ω±20%	30MHz
LQH3NPZ150MJR□	—	15μH ±20%	1MHz	650mA	870mA(Ambient temp.85°C) 370mA(Ambient temp.105°C)	0.38Ω±20%	25MHz
LQH3NPZ220MJR□	—	22μH ±20%	1MHz	520mA	800mA(Ambient temp.85°C) 350mA(Ambient temp.105°C)	0.50Ω±20%	20MHz
LQH3NPZ330MJR□	—	33μH ±20%	1MHz	420mA	630mA(Ambient temp.85°C) 280mA(Ambient temp.105°C)	0.79Ω±20%	15MHz
LQH3NPZ470MJR□	—	47μH ±20%	1MHz	360mA	570mA(Ambient temp.85°C) 240mA(Ambient temp.105°C)	1.0Ω±20%	10MHz

Operating temp.range (Self-temp.rise included): -40 to 125°C

Operating temp.range (Self-temp.rise not included): -40 to 105°C

Class of Magnetic Shield: Magnetic Resin

Only for reflow soldering

\*Isat: Rated Current based on Inductance change

\*Itemp: Rated Current based on Temperature rise

\*S.R.F: Self Resonant Frequency

When rated current is applied to the products, inductance will be within ±30% of initial inductance value range. Keep the temperature (ambient temperature plus self-generation of heat) under 125°C. When rated current is applied to the products, the self-temperature rise shall be limited to 40°C max. (ambient temperature 85°C). When rated current is applied to the products, the self-temperature rise shall be limited to 20°C max. (ambient temperature 85°C to 105°C).

Continued on the following page. ↗

Continued from the preceding page. ↘

**Inductance-Frequency Characteristics (Typ.)**

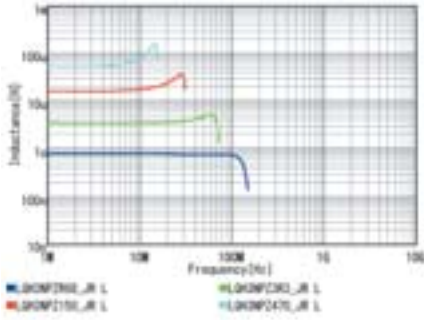

**Inductance-Current Characteristics (Typ.)**

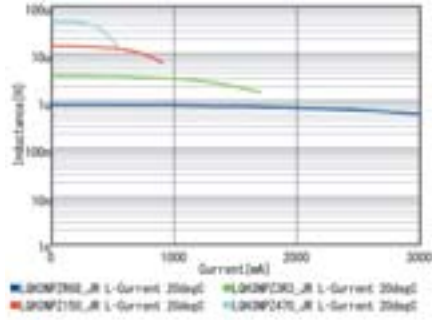

**Temperature Rise Characteristics (Typ.)**

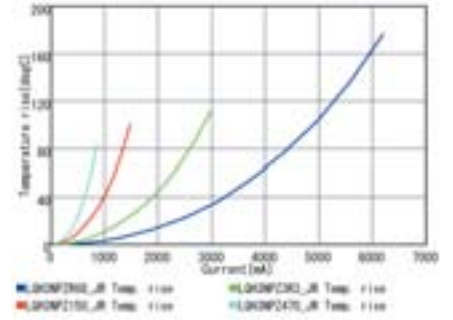

Inductors for Power Lines  
 Inductors for General Circuits  
 RF Inductors

## Inductors for Power Lines

# LQH3NPZ\_ME Series 1212 (3030) inch (mm)

### Appearance/Dimensions

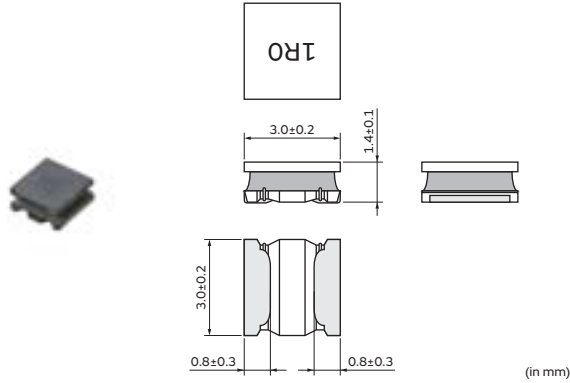

### Packaging

Code	Packaging	Minimum Quantity
L	ø180mm Embossed Taping	2000

### Rated Value (□: packaging code)

Part Number		Inductance	Inductance Test Frequency	Rated Current (I <sub>sat</sub> )*	Rated Current (I <sub>temp</sub> )*	DC Resistance	S.R.F.* (min.)
Infotainment	Powertrain/Safety						
LQH3NPZ1R0MME□	—	1.0μH ±20%	1MHz	2350mA	3000mA(Ambient temp.85°C) 1600mA(Ambient temp.105°C)	0.025Ω±20%	100MHz
LQH3NPZ2R2MME□	—	2.2μH ±20%	1MHz	1800mA	2100mA(Ambient temp.85°C) 1220mA(Ambient temp.105°C)	0.065Ω±20%	60MHz
LQH3NPZ3R3MME□	—	3.3μH ±20%	1MHz	1520mA	1900mA(Ambient temp.85°C) 1150mA(Ambient temp.105°C)	0.084Ω±20%	55MHz
LQH3NPZ4R7MME□	—	4.7μH ±20%	1MHz	1300mA	1700mA(Ambient temp.85°C) 1000mA(Ambient temp.105°C)	0.10Ω±20%	40MHz
LQH3NPZ6R8MME□	—	6.8μH ±20%	1MHz	1040mA	1450mA(Ambient temp.85°C) 900mA(Ambient temp.105°C)	0.14Ω±20%	30MHz
LQH3NPZ100MME□	—	10μH ±20%	1MHz	810mA	1280mA(Ambient temp.85°C) 800mA(Ambient temp.105°C)	0.19Ω±20%	20MHz
LQH3NPZ150MME□	—	15μH ±20%	1MHz	660mA	1020mA(Ambient temp.85°C) 620mA(Ambient temp.105°C)	0.29Ω±20%	15MHz
LQH3NPZ220MME□	—	22μH ±20%	1MHz	570mA	860mA(Ambient temp.85°C) 540mA(Ambient temp.105°C)	0.40Ω±20%	10MHz
LQH3NPZ330MME□	—	33μH ±20%	1MHz	440mA	760mA(Ambient temp.85°C) 460mA(Ambient temp.105°C)	0.55Ω±20%	8MHz
LQH3NPZ470MME□	—	47μH ±20%	1MHz	380mA	610mA(Ambient temp.85°C) 380mA(Ambient temp.105°C)	0.82Ω±20%	5MHz
LQH3NPZ560MME□	—	56μH ±20%	1MHz	350mA	500mA(Ambient temp.85°C) 320mA(Ambient temp.105°C)	1.0Ω±20%	5MHz
LQH3NPZ680MME□	—	68μH ±20%	1MHz	310mA	470mA(Ambient temp.85°C) 300mA(Ambient temp.105°C)	1.15Ω±20%	5MHz
LQH3NPZ101MME□	—	100μH ±20%	1MHz	260mA	430mA(Ambient temp.85°C) 270mA(Ambient temp.105°C)	1.59Ω±20%	3MHz

Operating temp.range (Self-temp.rise included): -40 to 125°C

Operating temp.range (Self-temp.rise not included): -40 to 105°C

Class of Magnetic Shield: Magnetic Resin

Only for reflow soldering

\*I<sub>sat</sub>: Rated Current based on Inductance change

\*I<sub>temp</sub>: Rated Current based on Temperature rise

\*S.R.F.: Self Resonant Frequency

When rated current is applied to the products, inductance will be within ±30% of initial inductance value range. Keep the temperature (ambient temperature plus self-generation of heat) under 125°C. When rated current is applied to the products, the self-temperature rise shall be limited to 40°C max. (ambient temperature 85°C). When rated current is applied to the products, the self-temperature rise shall be limited to 20°C max. (ambient temperature 85°C to 105°C).

Continued on the following page. ↗

Continued from the preceding page. ↘

**Inductance-Frequency Characteristics (Typ.)**

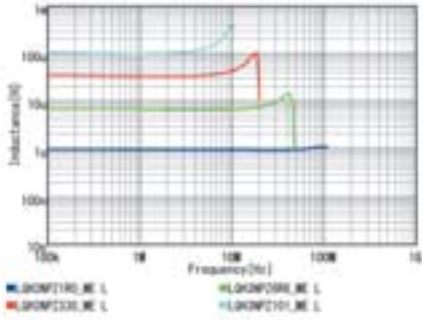

**Inductance-Current Characteristics (Typ.)**

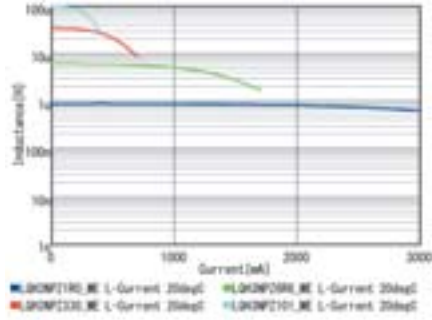

**Temperature Rise Characteristics (Typ.)**

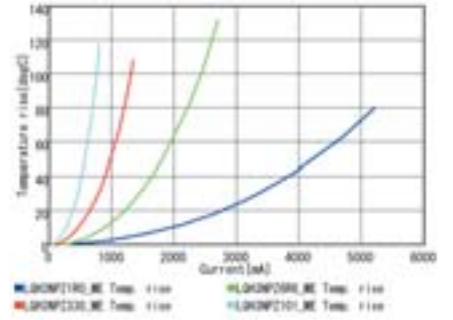

Inductors for Power Lines  
 Inductors for General Circuits  
 RF Inductors

## Inductors for Power Lines

# LQH44PZ\_GR Series 1515 (4040) inch (mm)

### Appearance/Dimensions

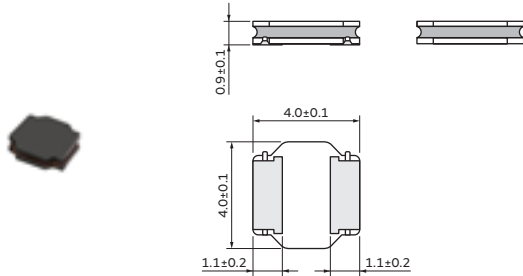

(in mm)

### Packaging

Code	Packaging	Minimum Quantity
K	ø330mm Embossed Taping	4500
L	ø180mm Embossed Taping	1000

### Rated Value (□: packaging code)

Part Number		Inductance	Inductance Test Frequency	Rated Current (Isat)*	Rated Current (Itemp)*	DC Resistance	S.R.F* (min.)
Infotainment	Powertrain/Safety						
LQH44PZR68NGR□	—	0.68μH ±30%	1MHz	2400mA	2500mA(Ambient temp.85°C) 1500mA(Ambient temp.105°C)	0.043Ω±20%	54MHz
LQH44PZR2R2NGR□	—	2.2μH ±30%	1MHz	1600mA	2000mA(Ambient temp.85°C) 1200mA(Ambient temp.105°C)	0.074Ω±20%	45MHz
LQH44PZR3R3NGR□	—	3.3μH ±30%	1MHz	1500mA	1700mA(Ambient temp.85°C) 1000mA(Ambient temp.105°C)	0.11Ω±20%	25MHz
LQH44PZR4R7MGR□	—	4.7μH ±20%	1MHz	1200mA	1600mA(Ambient temp.85°C) 960mA(Ambient temp.105°C)	0.13Ω±20%	17MHz
LQH44PZR6R8MGR□	—	6.8μH ±20%	1MHz	850mA	1400mA(Ambient temp.85°C) 840mA(Ambient temp.105°C)	0.17Ω±20%	15MHz
LQH44PZ100MGR□	—	10μH ±20%	1MHz	800mA	1100mA(Ambient temp.85°C) 660mA(Ambient temp.105°C)	0.27Ω±20%	13MHz
LQH44PZ150MGR□	—	15μH ±20%	1MHz	640mA	900mA(Ambient temp.85°C) 540mA(Ambient temp.105°C)	0.42Ω±20%	10MHz
LQH44PZ220MGR□	—	22μH ±20%	1MHz	500mA	750mA(Ambient temp.85°C) 450mA(Ambient temp.105°C)	0.57Ω±20%	8MHz
LQH44PZ330MGR□	—	33μH ±20%	1MHz	400mA	480mA(Ambient temp.85°C) 280mA(Ambient temp.105°C)	1.4Ω±20%	6MHz
LQH44PZ470MGR□	—	47μH ±20%	1MHz	360mA	410mA(Ambient temp.85°C) 240mA(Ambient temp.105°C)	1.7Ω±20%	6MHz

Operating temp.range (Self-temp.rise included): -40 to 125°C

Operating temp.range (Self-temp.rise not included): -40 to 105°C

Class of Magnetic Shield: Magnetic Resin

Only for reflow soldering

\*Isat: Rated Current based on Inductance change

\*Itemp: Rated Current based on Temperature rise

\*S.R.F: Self Resonant Frequency

When rated current is applied to the products, inductance will be within ±30% of initial inductance value range. Keep the temperature (ambient temperature plus self-generation of heat) under 125°C. When rated current is applied to the products, the self-temperature rise shall be limited to 40°C Max(ambient temperature 85°C). When rated current is applied to the products, the self-temperature rise shall be limited to 20°C max(ambient temperature 85-105°C).

Continued on the following page. ↗

Continued from the preceding page. ↘

**Inductance-Frequency Characteristics (Typ.)**

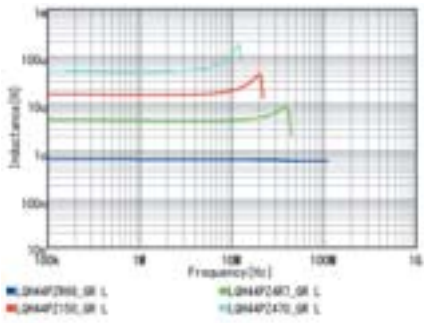

**Inductance-Current Characteristics (Typ.)**

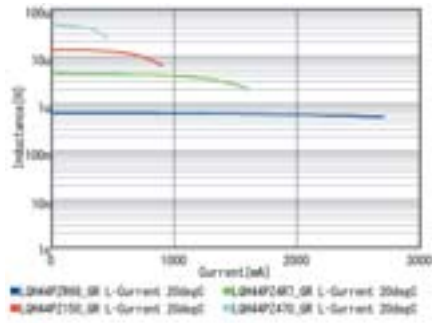

**Temperature Rise Characteristics (Typ.)**

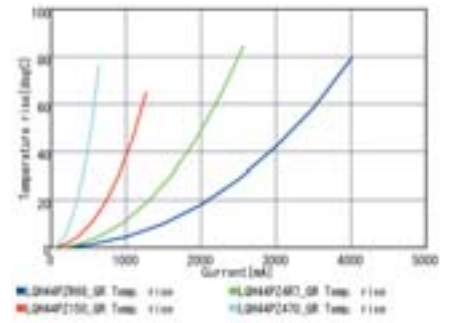

Inductors for Power Lines  
 Inductors for General Circuits  
 RF Inductors



## Inductors for Power Lines

# LQH43PZ\_26/LQH43PH\_26 Series 1812 (4532) inch (mm)

### Appearance/Dimensions

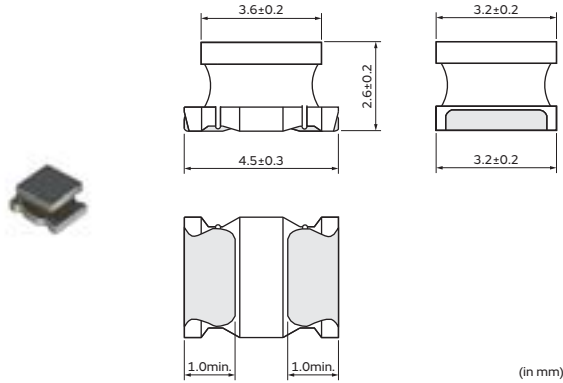

### Packaging

Code	Packaging	Minimum Quantity
K	ø330mm Embossed Taping	2500
L	ø180mm Embossed Taping	500

### Rated Value (□: packaging code)

Part Number		Inductance	Inductance Test Frequency	Rated Current (Isat)*	Rated Current (Itemp)*	DC Resistance	S.R.F* (min.)
Infotainment	Powertrain/Safety						
LQH43PZ1R0N26□	LQH43PH1R0N26□	1.0μH ±30%	1MHz	3400mA	3300mA(Ambient temp.85°C) 1410mA(Ambient temp.105°C)	0.026Ω±20%	100MHz
LQH43PZ2R2M26□	LQH43PH2R2M26□	2.2μH ±20%	1MHz	2300mA	2500mA(Ambient temp.85°C) 1120mA(Ambient temp.105°C)	0.042Ω±20%	45MHz
LQH43PZ3R3M26□	LQH43PH3R3M26□	3.3μH ±20%	1MHz	1800mA	2100mA(Ambient temp.85°C) 1000mA(Ambient temp.105°C)	0.052Ω±20%	40MHz
LQH43PZ4R7M26□	LQH43PH4R7M26□	4.7μH ±20%	1MHz	1400mA	1600mA(Ambient temp.85°C) 780mA(Ambient temp.105°C)	0.075Ω±20%	35MHz
LQH43PZ6R8M26□	LQH43PH6R8M26□	6.8μH ±20%	1MHz	1200mA	1400mA(Ambient temp.85°C) 760mA(Ambient temp.105°C)	0.098Ω±20%	30MHz
LQH43PZ8R2M26□	LQH43PH8R2M26□	8.2μH ±20%	1MHz	1100mA	1300mA(Ambient temp.85°C) 670mA(Ambient temp.105°C)	0.128Ω±20%	25MHz
LQH43PZ100M26□	LQH43PH100M26□	10μH ±20%	1MHz	1050mA	1170mA(Ambient temp.85°C) 620mA(Ambient temp.105°C)	0.147Ω±20%	20MHz
LQH43PZ220M26□	LQH43PH220M26□	22μH ±20%	1MHz	700mA	780mA(Ambient temp.85°C) 400mA(Ambient temp.105°C)	0.327Ω±20%	15MHz
LQH43PZ470M26□	LQH43PH470M26□	47μH ±20%	1MHz	470mA	520mA(Ambient temp.85°C) 280mA(Ambient temp.105°C)	0.718Ω±20%	8MHz
LQH43PZ101M26□	LQH43PH101M26□	100μH ±20%	1MHz	320mA	320mA(Ambient temp.85°C) 180mA(Ambient temp.105°C)	1.538Ω±20%	4MHz
LQH43PZ151M26□	LQH43PH151M26□	150μH ±20%	1MHz	280mA	260mA(Ambient temp.85°C) 140mA(Ambient temp.105°C)	2.362Ω±20%	3MHz
LQH43PZ221M26□	LQH43PH221M26□	220μH ±20%	1MHz	220mA	240mA(Ambient temp.85°C) 130mA(Ambient temp.105°C)	2.900Ω±20%	2MHz

Operating temp.range (Self-temp.rise included): -40 to 125°C  
 Operating temp.range (Self-temp.rise not included): -40 to 105°C  
 Class of Magnetic Shield: Magnetic Resin  
 Only for reflow soldering

\*Isat: Rated Current based on Inductance change

\*Itemp: Rated Current based on Temperature rise

\*S.R.F: Self Resonant Frequency

When rated current is applied to the products, inductance will be within ±30% of nominal inductance value. When rated current is applied to the products, the temperature rise caused by self-generated heat shall be limited to 40°C max. Keep the temperature (ambient temperature plus self-generation of heat) under 125°C.

Continued on the following page. ↗

Continued from the preceding page. ↘

**Inductance-Frequency Characteristics (Typ.)**

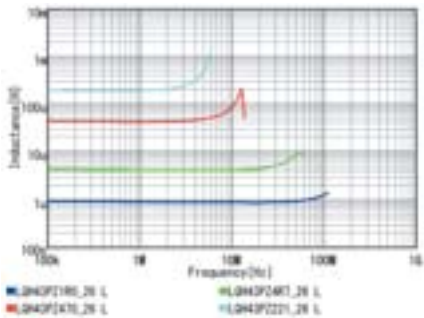

**Inductance-Current Characteristics (Typ.)**

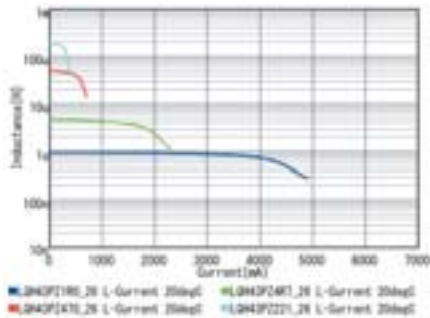

**Temperature Rise Characteristics (Typ.)**

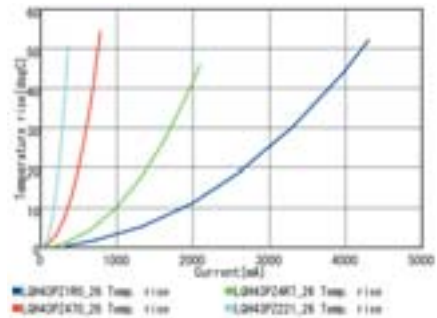

Inductors for Power Lines  
 Inductors for General Circuits  
 RF Inductors

## Inductors for Power Lines

# LQH5BPZ\_T0 Series 2020 (5050) inch (mm)

### Appearance/Dimensions

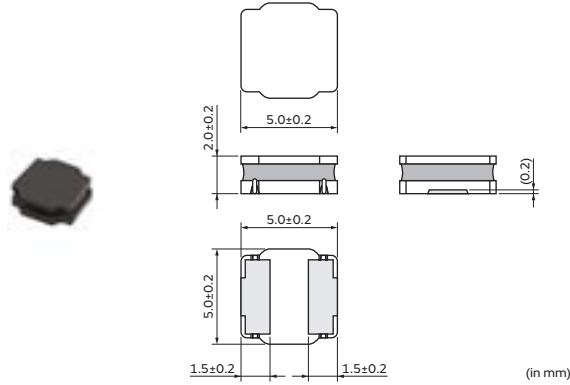

### Packaging

Code	Packaging	Minimum Quantity
K	ø330mm Embossed Taping	3000
L	ø180mm Embossed Taping	500

### Rated Value (□: packaging code)

Part Number		Inductance	Inductance Test Frequency	Rated Current (Isat)*	Rated Current (Itemp)*	DC Resistance	S.R.F* (min.)
Infotainment	Powertrain/Safety						
LQH5BPZR47NT0□	—	0.47μH ±30%	100kHz	7.7A	4.0A(Ambient temp.85°C) 2.05A(Ambient temp.105°C)	0.012Ω±20%	220MHz
LQH5BPZ1R0NT0□	—	1.0μH ±30%	100kHz	5.8A	3.1A(Ambient temp.85°C) 1.68A(Ambient temp.105°C)	0.019Ω±20%	90MHz
LQH5BPZ1R2NT0□	—	1.2μH ±30%	100kHz	5.4A	3.1A(Ambient temp.85°C) 1.68A(Ambient temp.105°C)	0.019Ω±20%	90MHz
LQH5BPZ1R5NT0□	—	1.5μH ±30%	100kHz	5.0A	3.0A(Ambient temp.85°C) 1.63A(Ambient temp.105°C)	0.024Ω±20%	70MHz
LQH5BPZ2R2NT0□	—	2.2μH ±30%	100kHz	4.0A	2.6A(Ambient temp.85°C) 1.37A(Ambient temp.105°C)	0.030Ω±20%	55MHz
LQH5BPZ2R7NT0□	—	2.7μH ±30%	100kHz	3.8A	2.5A(Ambient temp.85°C) 1.23A(Ambient temp.105°C)	0.035Ω±20%	50MHz
LQH5BPZ3R3NT0□	—	3.3μH ±30%	100kHz	3.5A	2.3A(Ambient temp.85°C) 1.21A(Ambient temp.105°C)	0.044Ω±20%	40MHz
LQH5BPZ4R7NT0□	—	4.7μH ±30%	100kHz	3.0A	2.0A(Ambient temp.85°C) 1.09A(Ambient temp.105°C)	0.058Ω±20%	40MHz
LQH5BPZ6R8NT0□	—	6.8μH ±30%	100kHz	2.5A	1.65A(Ambient temp.85°C) 0.96A(Ambient temp.105°C)	0.083Ω±20%	30MHz
LQH5BPZ100MT0□	—	10μH ±20%	100kHz	2.0A	1.60A(Ambient temp.85°C) 0.87A(Ambient temp.105°C)	0.106Ω±20%	25MHz
LQH5BPZ150MT0□	—	15μH ±20%	100kHz	1.6A	1.20A(Ambient temp.85°C) 0.62A(Ambient temp.105°C)	0.187Ω±20%	18MHz
LQH5BPZ220MT0□	—	22μH ±20%	100kHz	1.4A	1.05A(Ambient temp.85°C) 0.55A(Ambient temp.105°C)	0.259Ω±20%	15MHz

Operating temp.range (Self-temp.rise included): -40 to 125°C

Operating temp.range (Self-temp.rise not included): -40 to 105°C

Class of Magnetic Shield: Magnetic Resin

Only for reflow soldering

\*Isat: Rated Current based on Inductance change

\*Itemp: Rated Current based on Temperature rise

\*S.R.F: Self Resonant Frequency

When rated current is applied to the products, inductance will be within ±30% of initial inductance value. When rated current is applied to the products, self-temperature rise shall be limited to 40°C max. Keep the temperature (ambient temperature plus self-generation of heat) under 125°C.

Continued on the following page. ↗

Continued from the preceding page. ↘

**Inductance-Frequency Characteristics (Typ.)**

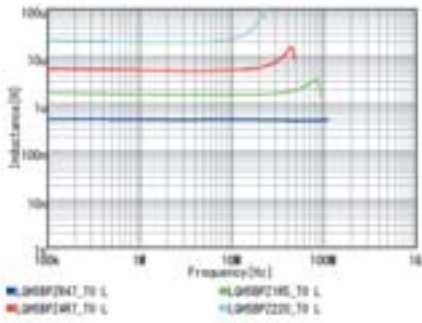

**Inductance-Current Characteristics (Typ.)**

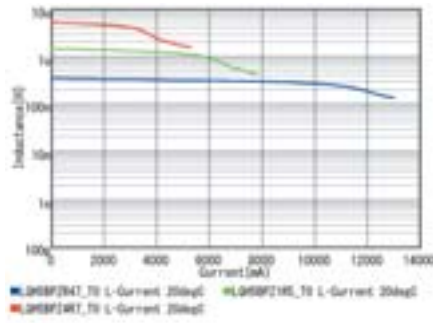

**Temperature Rise Characteristics (Typ.)**

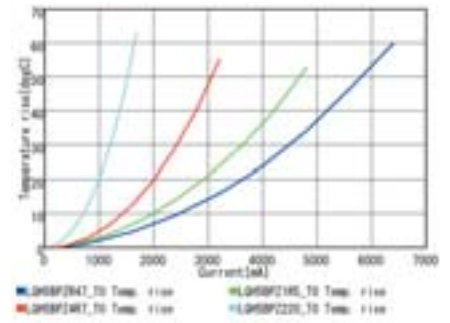

Inductors for Power Lines  
 Inductors for General Circuits  
 RF Inductors

## Inductors for Power Lines

# MBH6045C High Current Series 2424 (6262) inch (mm)

### Appearance/Dimensions

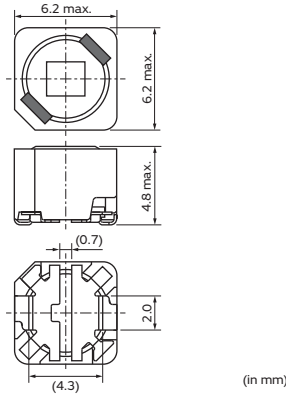

### Packaging

Code	Packaging	Minimum Quantity
=P3	ø330mm Embossed Taping	1000

### Rated Value (□: packaging code)

Part Number		Inductance	Inductance Test Frequency	Rated Current (Isat)*	Rated Current (Itemp)*	DC Resistance
Infotainment	Powertrain/Safety					
—	MBH6045C-1R5NA□	1.5μH ±30%	0.1MHz	6300mA	4300mA	0.017Ω±30%
—	MBH6045C-3R3NA□	3.3μH ±30%	0.1MHz	4100mA	3400mA	0.024Ω±30%
—	MBH6045C-4R7NA□	4.7μH ±30%	0.1MHz	3300mA	2800mA	0.029Ω±30%
—	MBH6045C-6R8NA□	6.8μH ±30%	0.1MHz	2700mA	2100mA	0.051Ω±30%
—	MBH6045C-100MA□	10μH ±20%	0.1MHz	2300mA	2000mA	0.063Ω±20%
—	MBH6045C-150MA□	15μH ±20%	0.1MHz	1800mA	1500mA	0.099Ω±20%
—	MBH6045C-220MA□	22μH ±20%	0.1MHz	1500mA	1200mA	0.139Ω±20%
—	MBH6045C-330MA□	33μH ±20%	0.1MHz	1200mA	1100mA	0.178Ω±20%
—	MBH6045C-470MA□	47μH ±20%	0.1MHz	1100mA	1000mA	0.256Ω±20%
—	MBH6045C-680MA□	68μH ±20%	0.1MHz	900mA	840mA	0.347Ω±20%
—	MBH6045C-101MA□	100μH ±20%	0.1MHz	710mA	700mA	0.487Ω±20%
—	MBH6045C-151MA□	150μH ±20%	0.1MHz	580mA	510mA	0.772Ω±20%
—	MBH6045C-221MA□	220μH ±20%	0.1MHz	470mA	480mA	1.080Ω±20%

Operating temp.range (Self-temp.rise included): -40 to 150°C

Inductance:

Measured with an LCR meter 4284A (Keysight) or equivalent.

RDC:

Measured with a Digital Multimeter TR6871 (Advantest) or equivalent.

Only for reflow soldering

\*Isat: Rated Current based on Inductance change

\*Itemp: Rated Current based on Temperature rise

Rated current (Isat) is specified when the decrease of the initial inductance value at 10%. (The ambient reference temperature is 25°C)

Rated current (Itemp) is specified when temperature of inductor the is raised 40°C by DC current. (The ambient reference temperature is 25°C)

Class of Magnetic Shield: Ferrite Core

### Inductance-Current Characteristics (Typ.)

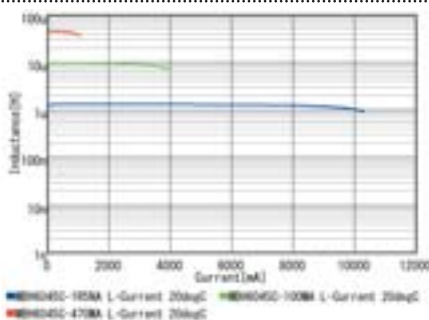

### Temperature Rise Characteristics (Typ.)

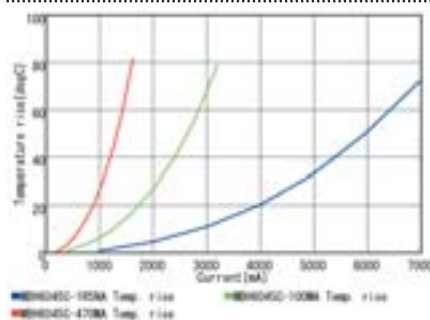

### Inductance-Frequency Characteristics (Typ.)

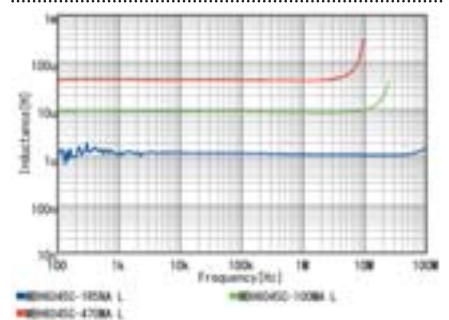

Continued on the following page. ↗

Continued from the preceding page. ↘

### Notice (Rating)

Max. current (DC, AC) as function of ambient temperature  
(derating curve).

Derating of Rated Current

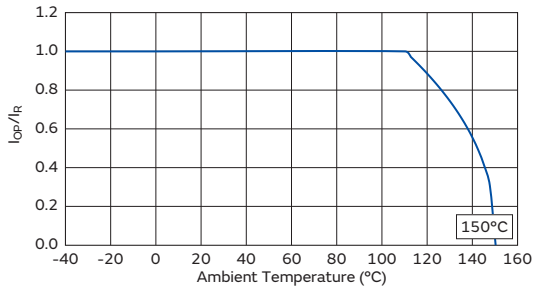

## Inductors for Power Lines

# MBH6045C Low Rdc Series 2424 (6262) inch (mm)

### Appearance/Dimensions

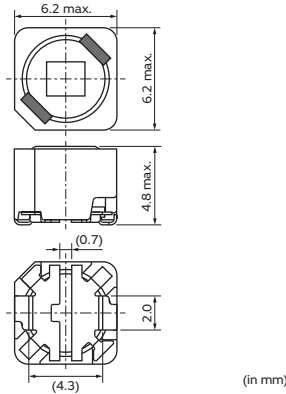

### Packaging

Code	Packaging	Minimum Quantity
=P3	ø330mm Embossed Taping	1000

### Rated Value (□: packaging code)

Part Number		Inductance	Inductance Test Frequency	Rated Current (Isat)*	Rated Current (Itemp)*	DC Resistance
Infotainment	Powertrain/Safety					
—	MBH6045C-1R0ND□	1.0μH ±30%	0.1MHz	4400mA	4400mA	0.014Ω±30%
—	MBH6045C-1R5NB□	1.5μH ±30%	0.1MHz	3500mA	4400mA	0.015Ω±30%
—	MBH6045C-3R3NB□	3.3μH ±30%	0.1MHz	2300mA	3500mA	0.019Ω±30%
—	MBH6045C-4R7NB□	4.7μH ±30%	0.1MHz	2000mA	3200mA	0.023Ω±30%
—	MBH6045C-6R8NB□	6.8μH ±30%	0.1MHz	1600mA	2600mA	0.027Ω±30%
—	MBH6045C-100MB□	10μH ±20%	0.1MHz	1200mA	2500mA	0.038Ω±20%
—	MBH6045C-150MB□	15μH ±20%	0.1MHz	900mA	2100mA	0.055Ω±20%
—	MBH6045C-220MB□	22μH ±20%	0.1MHz	900mA	1700mA	0.078Ω±20%
—	MBH6045C-330MB□	33μH ±20%	0.1MHz	700mA	1500mA	0.103Ω±20%
—	MBH6045C-470MB□	47μH ±20%	0.1MHz	560mA	1100mA	0.130Ω±20%
—	MBH6045C-680MB□	68μH ±20%	0.1MHz	480mA	940mA	0.215Ω±20%
—	MBH6045C-101MB□	100μH ±20%	0.1MHz	400mA	830mA	0.340Ω±20%
—	MBH6045C-151MB□	150μH ±20%	0.1MHz	320mA	710mA	0.480Ω±20%
—	MBH6045C-221MB□	220μH ±20%	0.1MHz	260mA	560mA	0.780Ω±20%
—	MBH6045C-331MB□	330μH ±20%	0.1MHz	230mA	480mA	0.970Ω±20%
—	MBH6045C-471MB□	470μH ±20%	0.1MHz	180mA	410mA	1.420Ω±20%

Operating temp.range (Self-temp.rise included): -40 to 150°C

Inductance:

Measured with an LCR meter 4284A (Keysight) or equivalent.

RDC:

Measured with a Digital Multimeter TR6871 (Advantest) or equivalent.

Only for reflow soldering

\*Isat: Rated Current based on Inductance change

\*Itemp: Rated Current based on Temperature rise

Rated current (Isat) is specified when the decrease of the initial inductance value at 10%. (The ambient reference temperature is 25°C)

Rated current (Itemp) is specified when temperature of inductor the is raised 40°C by DC current. (The ambient reference temperature is 25°C)

Class of Magnetic Shield: Ferrite Core

Continued on the following page. ↗

Continued from the preceding page. ↘

**Inductance-Current Characteristics (Typ.)**

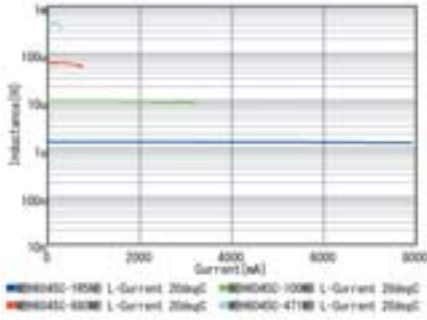

**Temperature Rise Characteristics (Typ.)**

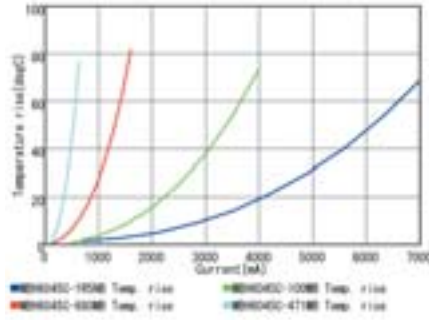

**Inductance-Frequency Characteristics (Typ.)**

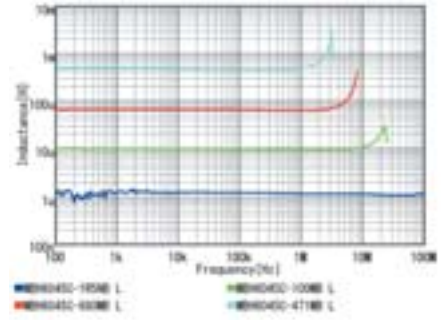

**Notice (Rating)**

Max. current (DC, AC) as function of ambient temperature (derating curve).

Derating of Rated Current





## Inductors for Power Lines

# MDH6045C High Current Series 2524 (6360) inch (mm)

### Appearance/Dimensions

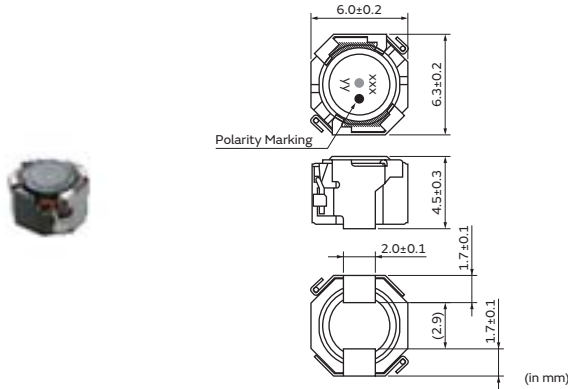

### Packaging

Code	Packaging	Minimum Quantity
=P3	ø330mm Embossed Taping	1000

### Rated Value (□: packaging code)

Part Number		Inductance	Inductance Test Frequency	Rated Current (Isat)*	Rated Current (Itemp)*	DC Resistance
Infotainment	Powertrain/Safety					
—	MDH6045C-1R0NA□	1.0μH ±30%	0.1MHz	5800mA	3900mA	0.011Ω±30%
—	MDH6045C-1R5NA□	1.5μH ±30%	0.1MHz	5000mA	3600mA	0.013Ω±30%
—	MDH6045C-2R2NA□	2.2μH ±30%	0.1MHz	4200mA	3400mA	0.015Ω±30%
—	MDH6045C-3R3NA□	3.3μH ±30%	0.1MHz	3600mA	3000mA	0.019Ω±30%
—	MDH6045C-4R7NA□	4.7μH ±30%	0.1MHz	2900mA	2700mA	0.023Ω±30%
—	MDH6045C-6R8NA□	6.8μH ±30%	0.1MHz	2500mA	2500mA	0.027Ω±30%
—	MDH6045C-100MA□	10μH ±20%	0.1MHz	2000mA	1900mA	0.040Ω±30%
—	MDH6045C-150MA□	15μH ±20%	0.1MHz	1600mA	1700mA	0.060Ω±30%
—	MDH6045C-220MA□	22μH ±20%	0.1MHz	1400mA	1400mA	0.082Ω±30%
—	MDH6045C-330MA□	33μH ±20%	0.1MHz	1000mA	1200mA	0.130Ω±30%
—	MDH6045C-470MA□	47μH ±20%	0.1MHz	880mA	1000mA	0.160Ω±30%
—	MDH6045C-680MA□	68μH ±20%	0.1MHz	720mA	800mA	0.220Ω±30%
—	MDH6045C-101MA□	100μH ±20%	0.1MHz	600mA	640mA	0.340Ω±30%
—	MDH6045C-151MA□	150μH ±20%	0.1MHz	520mA	540mA	0.520Ω±30%
—	MDH6045C-221MA□	220μH ±20%	0.1MHz	400mA	440mA	0.720Ω±30%

Operating temp.range (Self-temp.rise included): -55 to 150°C

Inductance:

Measured with an LCR meter 4284A (Keysight) or equivalent.

RDC:

Measured with a Digital Multimeter TR6871 (Advantest) or equivalent.

Only for reflow soldering

\*Isat: Rated Current based on Inductance change

\*Itemp: Rated Current based on Temperature rise

The saturation allowable DC current value is specified when the decrease of the nominal Inductance value at 30%. (The ambient reference temperature is 20°C)

Rated Current (Based on Temperature rise) is specified when temperature of the inductor on our PCB for test purpose is raised 40°C by DC current. (The ambient reference temperature is 20°C)

Class of Magnetic Shield: Ferrite Core

Continued on the following page. ↗

Continued from the preceding page. ↘

**Inductance-Current Characteristics (Typ.)**

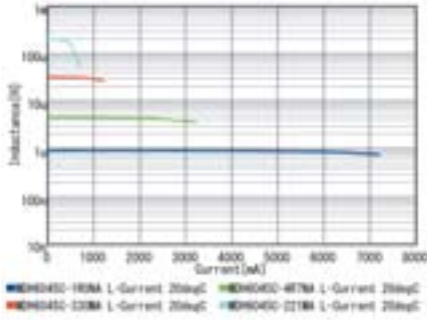

**Temperature Rise Characteristics (Typ.)**

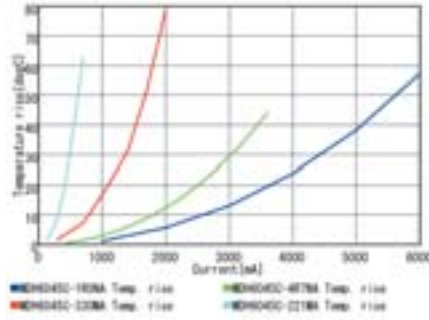

**Inductance-Frequency Characteristics (Typ.)**

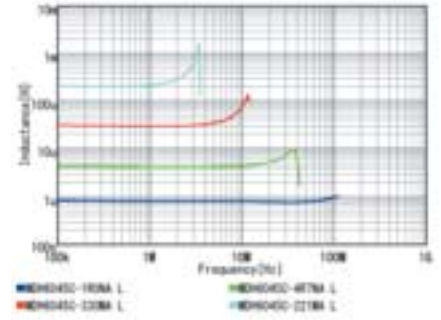

**Notice (Rating)**

Max. current (DC, AC) as function of ambient temperature (derating curve).

Derating of Rated Current

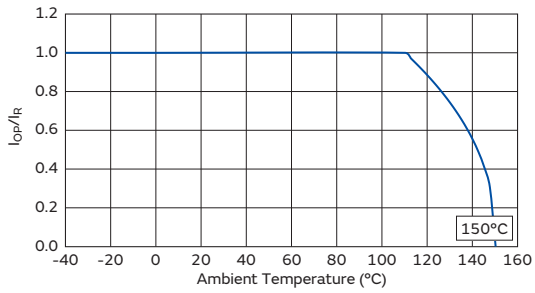

## Inductors for Power Lines

# MDH6045C Low Rdc Series 2524 (6360) inch (mm)

### Appearance/Dimensions

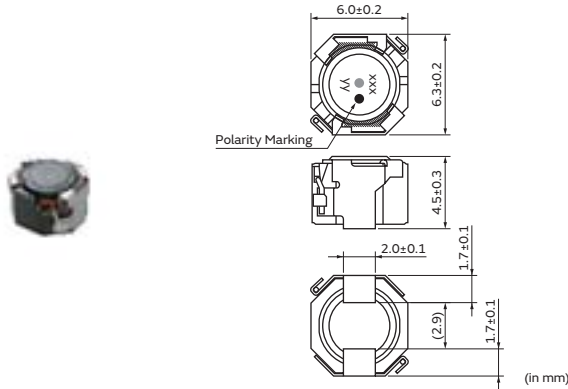

### Packaging

Code	Packaging	Minimum Quantity
=P3	ø330mm Embossed Taping	1000

### Rated Value (□: packaging code)

Part Number		Inductance	Inductance Test Frequency	Rated Current (Isat)*	Rated Current (Itemp)*	DC Resistance
Infotainment	Powertrain/Safety					
—	MDH6045C-1R2NB□	1.2μH ±30%	0.1MHz	5500mA	3800mA	0.011Ω±30%
—	MDH6045C-100MB□	10μH ±20%	0.1MHz	1800mA	2000mA	0.038Ω±30%
—	MDH6045C-150MB□	15μH ±20%	0.1MHz	1400mA	1800mA	0.055Ω±30%
—	MDH6045C-220MB□	22μH ±20%	0.1MHz	1200mA	1400mA	0.080Ω±30%
—	MDH6045C-330MB□	33μH ±20%	0.1MHz	960mA	1300mA	0.105Ω±30%
—	MDH6045C-470MB□	47μH ±20%	0.1MHz	760mA	1100mA	0.130Ω±30%
—	MDH6045C-680MB□	68μH ±20%	0.1MHz	680mA	840mA	0.200Ω±30%
—	MDH6045C-101MB□	100μH ±20%	0.1MHz	560mA	680mA	0.340Ω±30%
—	MDH6045C-151MB□	150μH ±20%	0.1MHz	440mA	580mA	0.500Ω±30%
—	MDH6045C-221MB□	220μH ±20%	0.1MHz	360mA	480mA	0.700Ω±30%
—	MDH6045C-331MB□	330μH ±20%	0.1MHz	300mA	380mA	0.970Ω±30%
—	MDH6045C-471MB□	470μH ±20%	0.1MHz	240mA	340mA	1.450Ω±30%

Operating temp.range (Self-temp.rise included): -55 to 150°C

Inductance:

Measured with an LCR meter 4284A (Keysight) or equivalent.

RDC:

Measured with a Digital Multimeter TR6871 (Advantest) or equivalent.

Only for reflow soldering

\*Isat: Rated Current based on Inductance change

\*Itemp: Rated Current based on Temperature rise

The saturation allowable DC current value is specified when the decrease of the nominal Inductance value at 30%.(The ambient reference temperature is 20°C)

Rated Current (Based on Temperature rise) is specified when temperature of the inductor on our PCB for test purpose is raised 40°C by DC current.(The ambient reference temperature is 20°C)

Class of Magnetic Shield: Ferrite Core

### Inductance-Current Characteristics (Typ.)

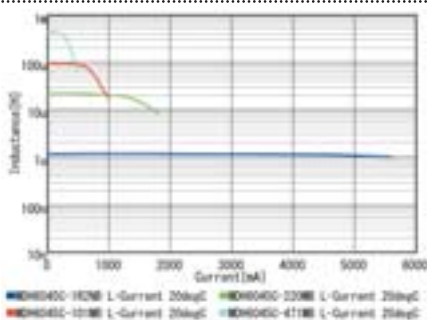

### Temperature Rise Characteristics (Typ.)

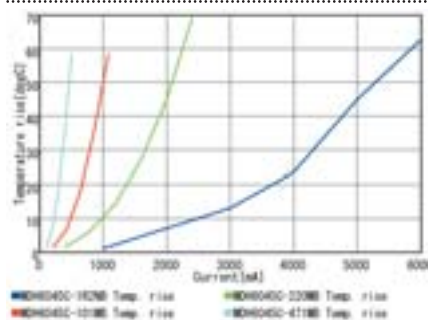

### Inductance-Frequency Characteristics (Typ.)

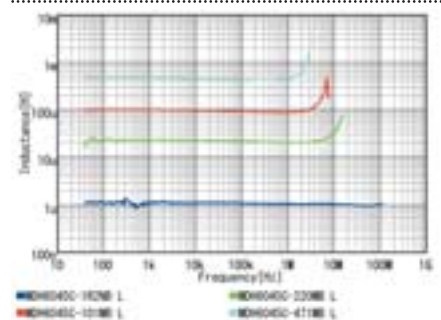

Continued on the following page. ↗

Continued from the preceding page. ↘

### Notice (Rating)

Max. current (DC, AC) as function of ambient temperature  
(derating curve).

Derating of Rated Current



## Inductors for Power Lines

# MBH7045C High Current Series 2828 (7272) inch (mm)

### Appearance/Dimensions

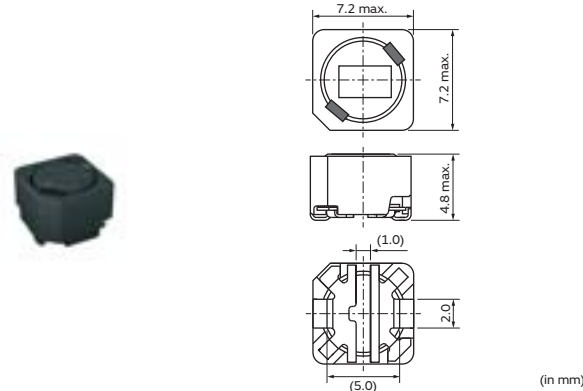

### Packaging

Code	Packaging	Minimum Quantity
=P3	ø330mm Embossed Taping	1000

### Rated Value (□: packaging code)

Part Number		Inductance	Inductance Test Frequency	Rated Current (Isat)*	Rated Current (Itemp)*	DC Resistance
Infotainment	Powertrain/Safety					
—	MBH7045C-2R2NB□	2.2μH ±30%	0.1MHz	4600mA	3500mA	0.0155Ω±20%
—	MBH7045C-3R3NB□	3.3μH ±30%	0.1MHz	3300mA	3400mA	0.021Ω±20%
—	MBH7045C-4R7NB□	4.7μH ±30%	0.1MHz	3000mA	2900mA	0.024Ω±20%
—	MBH7045C-6R8NB□	6.8μH ±30%	0.1MHz	2400mA	2800mA	0.029Ω±20%
—	MBH7045C-100MB□	10μH ±20%	0.1MHz	2000mA	2700mA	0.036Ω±20%
—	MBH7045C-150MB□	15μH ±20%	0.1MHz	1600mA	2100mA	0.054Ω±20%
—	MBH7045C-220MB□	22μH ±20%	0.1MHz	1400mA	1800mA	0.070Ω±20%
—	MBH7045C-330MB□	33μH ±20%	0.1MHz	1100mA	1500mA	0.105Ω±20%
—	MBH7045C-470MB□	47μH ±20%	0.1MHz	900mA	1100mA	0.150Ω±20%
—	MBH7045C-680MB□	68μH ±20%	0.1MHz	750mA	1000mA	0.210Ω±20%
—	MBH7045C-101MB□	100μH ±20%	0.1MHz	630mA	840mA	0.310Ω±20%
—	MBH7045C-151MB□	150μH ±20%	0.1MHz	510mA	670mA	0.460Ω±20%
—	MBH7045C-221MB□	220μH ±20%	0.1MHz	400mA	550mA	0.690Ω±20%

Operating temp.range (Self-temp.rise included): -40 to 150°C

Inductance:

Measured with an LCR meter 4284A (Keysight) or equivalent.

RDC:

Measured with a Digital Multimeter TR6871 (Advantest) or equivalent.

Only for reflow soldering

\*Isat: Rated Current based on Inductance change

\*Itemp: Rated Current based on Temperature rise

Rated current (Isat) is specified when the decrease of the initial inductance value at 10%. (The ambient reference temperature is 25°C)

Rated current (Itemp) is specified when temperature of inductor the is raised 40°C by DC current. (The ambient reference temperature is 25°C)

Class of Magnetic Shield: Ferrite Core

### Inductance-Current Characteristics (Typ.)

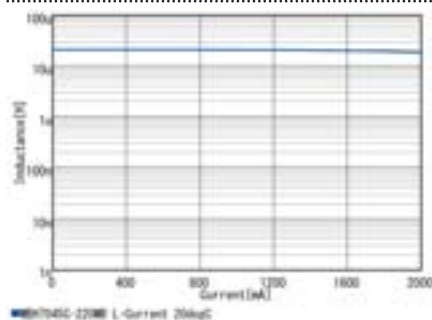

### Temperature Rise Characteristics (Typ.)

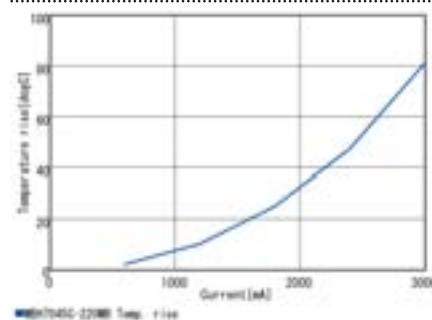

### Inductance-Frequency Characteristics (Typ.)

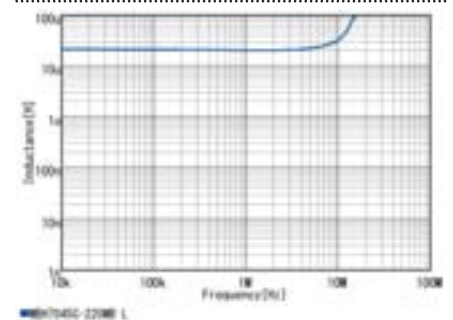

Continued on the following page. ↗

Continued from the preceding page. ↘

### Notice (Rating)

Max. current (DC, AC) as function of ambient temperature  
(derating curve).

Derating of Rated Current

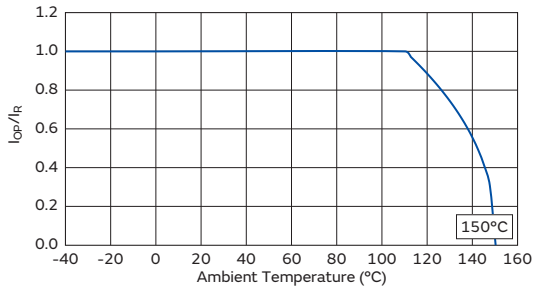

## Inductors for Power Lines

# MBH7045C Low Rdc Series 2828 (7272) inch (mm)

### Appearance/Dimensions

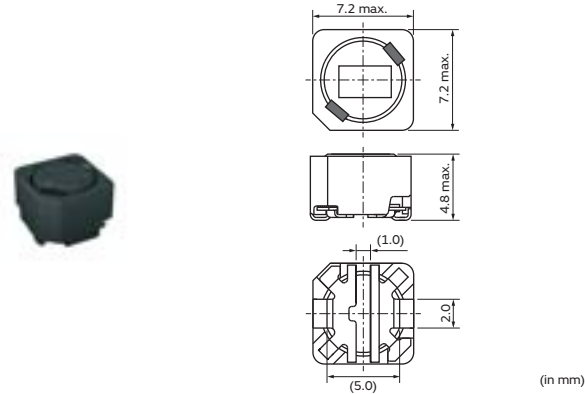

### Packaging

Code	Packaging	Minimum Quantity
=P3	ø330mm Embossed Taping	1000

### Rated Value (□: packaging code)

Part Number		Inductance	Inductance Test Frequency	Rated Current (Isat)*	Rated Current (Itemp)*	DC Resistance
Infotainment	Powertrain/Safety					
—	MBH7045C-3R3NA□	3.3μH ±30%	0.1MHz	2500mA	3500mA	0.019Ω±20%
—	MBH7045C-4R7NA□	4.7μH ±30%	0.1MHz	2000mA	3200mA	0.023Ω±20%
—	MBH7045C-6R8NA□	6.8μH ±30%	0.1MHz	1700mA	2700mA	0.028Ω±20%
—	MBH7045C-100MA□	10μH ±20%	0.1MHz	1300mA	2500mA	0.036Ω±20%
—	MBH7045C-150MA□	15μH ±20%	0.1MHz	1100mA	2100mA	0.052Ω±20%
—	MBH7045C-220MA□	22μH ±20%	0.1MHz	1000mA	1900mA	0.061Ω±20%
—	MBH7045C-330MA□	33μH ±20%	0.1MHz	800mA	1400mA	0.096Ω±20%
—	MBH7045C-470MA□	47μH ±20%	0.1MHz	700mA	1300mA	0.125Ω±20%
—	MBH7045C-680MA□	68μH ±20%	0.1MHz	590mA	1100mA	0.175Ω±20%
—	MBH7045C-101MA□	100μH ±20%	0.1MHz	480mA	1000mA	0.250Ω±20%
—	MBH7045C-151MA□	150μH ±20%	0.1MHz	390mA	790mA	0.340Ω±20%
—	MBH7045C-221MA□	220μH ±20%	0.1MHz	340mA	650mA	0.520Ω±20%
—	MBH7045C-331MA□	330μH ±20%	0.1MHz	250mA	540mA	0.740Ω±20%
—	MBH7045C-471MA□	470μH ±20%	0.1MHz	220mA	430mA	1.050Ω±20%
—	MBH7045C-681MA□	680μH ±20%	0.1MHz	200mA	360mA	1.480Ω±20%
—	MBH7045C-102MA□	1000μH ±20%	0.1MHz	140mA	310mA	2.280Ω±20%

Operating temp.range (Self-temp.rise included): -40 to 150°C

Inductance:

Measured with an LCR meter 4284A (Keysight) or equivalent.

RDC:

Measured with a Digital Multimeter TR6871 (Advantest) or equivalent.

Only for reflow soldering

\*Isat: Rated Current based on Inductance change

\*Itemp: Rated Current based on Temperature rise

Rated current (Isat) is specified when the decrease of the initial inductance value at 10%. (The ambient reference temperature is 25°C)

Rated current (Itemp) is specified when temperature of inductor the is raised 40°C by DC current. (The ambient reference temperature is 25°C)

Class of Magnetic Shield: Ferrite Core

Continued on the following page. ↗

Continued from the preceding page. ↘

**Inductance-Current Characteristics (Typ.)**

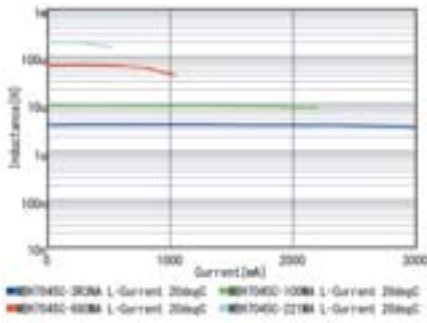

**Temperature Rise Characteristics (Typ.)**

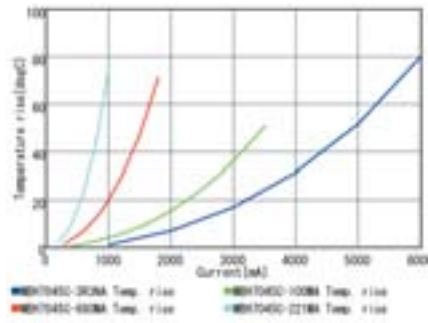

**Inductance-Frequency Characteristics (Typ.)**

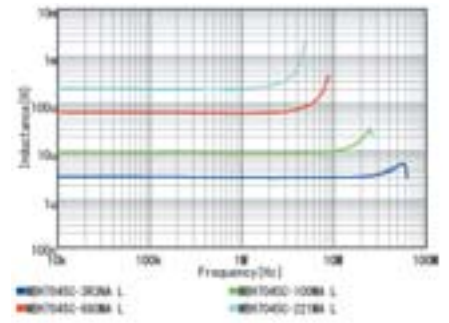

**Notice (Rating)**

Max. current (DC, AC) as function of ambient temperature (derating curve).

Derating of Rated Current

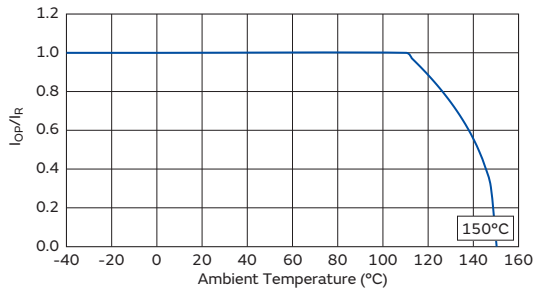



## Inductors for Power Lines

# MDH7045C Series 2928 (7470) inch (mm)

### Appearance/Dimensions

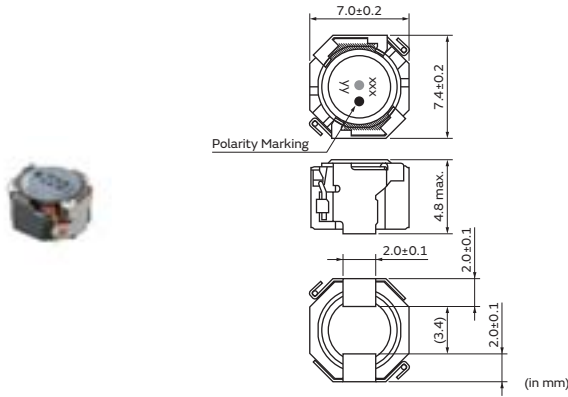

### Packaging

Code	Packaging	Minimum Quantity
=P3	ø330mm Embossed Taping	1000

### Rated Value (□: packaging code)

Part Number		Inductance	Inductance Test Frequency	Rated Current (Isat)*	Rated Current (Itemp)*	DC Resistance
Infotainment	Powertrain/Safety					
—	MDH7045C-1R0NB□	1.0μH ±30%	0.1MHz	8800mA	4700mA	0.009Ω±30%
—	MDH7045C-1R5NB□	1.5μH ±30%	0.1MHz	7100mA	4300mA	0.010Ω±30%
—	MDH7045C-2R2NB□	2.2μH ±30%	0.1MHz	5800mA	4100mA	0.013Ω±30%
—	MDH7045C-3R3NB□	3.3μH ±30%	0.1MHz	5000mA	3400mA	0.016Ω±30%
—	MDH7045C-4R7NB□	4.7μH ±30%	0.1MHz	4200mA	3000mA	0.018Ω±30%
—	MDH7045C-6R8NB□	6.8μH ±30%	0.1MHz	3400mA	2800mA	0.022Ω±30%
—	MDH7045C-100MA□	10μH ±20%	0.1MHz	2500mA	2600mA	0.033Ω±30%
—	MDH7045C-150MA□	15μH ±20%	0.1MHz	2000mA	1800mA	0.055Ω±30%
—	MDH7045C-220MA□	22μH ±20%	0.1MHz	1600mA	1700mA	0.069Ω±30%
—	MDH7045C-330MA□	33μH ±20%	0.1MHz	1400mA	1300mA	0.097Ω±30%
—	MDH7045C-470MA□	47μH ±20%	0.1MHz	1100mA	1100mA	0.13Ω±30%
—	MDH7045C-680MA□	68μH ±20%	0.1MHz	960mA	880mA	0.20Ω±30%
—	MDH7045C-101MA□	100μH ±20%	0.1MHz	750mA	800mA	0.29Ω±30%
—	MDH7045C-151MA□	150μH ±20%	0.1MHz	640mA	600mA	0.43Ω±30%
—	MDH7045C-221MA□	220μH ±20%	0.1MHz	530mA	510mA	0.55Ω±30%
—	MDH7045C-331MA□	330μH ±20%	0.1MHz	420mA	490mA	0.80Ω±30%
—	MDH7045C-471MA□	470μH ±20%	0.1MHz	360mA	350mA	1.20Ω±30%

Operating temp.range (Self-temp.rise included): -55 to 150°C

Inductance:

Measured with an LCR meter 4284A (Keysight) or equivalent.

RDC:

Measured with a Digital Multimeter TR6871 (Advantest) or equivalent.

Only for reflow soldering

\*Isat: Rated Current based on Inductance change

\*Itemp: Rated Current based on Temperature rise

The saturation allowable DC current value is specified when the decrease of the nominal Inductance value at 30%.(The ambient reference temperature is 20°C)

Rated Current (Based on Temperature rise) is specified when temperature of the inductor on our PCB for test purpose is raised 40°C by DC current.(The ambient reference temperature is 20°C)

Class of Magnetic Shield: Ferrite Core

Continued on the following page. ↗

Continued from the preceding page. ↘

**Inductance-Current Characteristics (Typ.)**

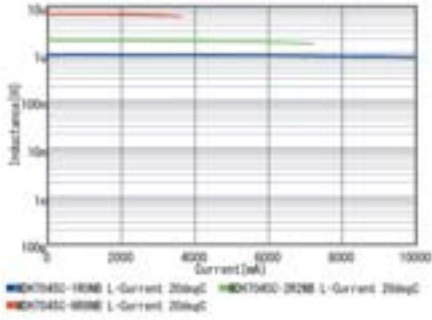

**Temperature Rise Characteristics (Typ.)**

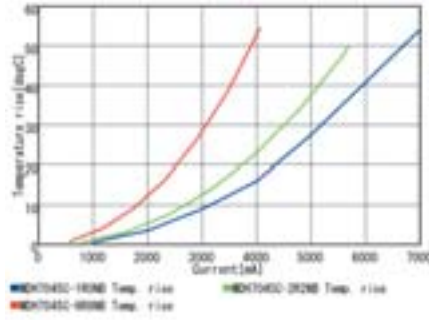

**Inductance-Frequency Characteristics (Typ.)**

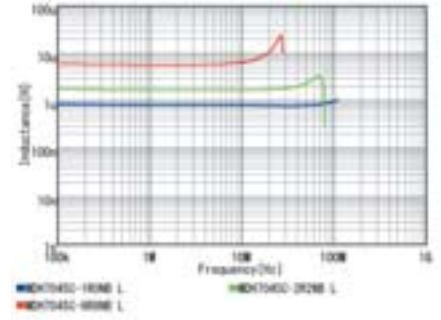

**Notice (Rating)**

Max. current (DC, AC) as function of ambient temperature (derating curve).

Derating of Rated Current

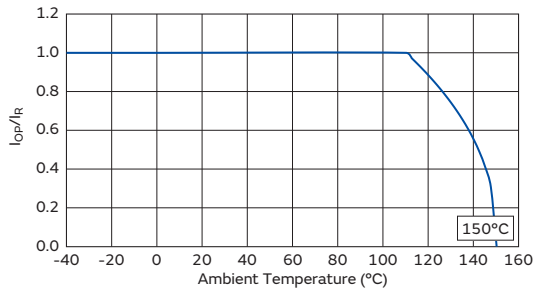

# Inductors for Power Lines

## MDH10060C Series 4039 (101100) inch (mm)

### Appearance/Dimensions

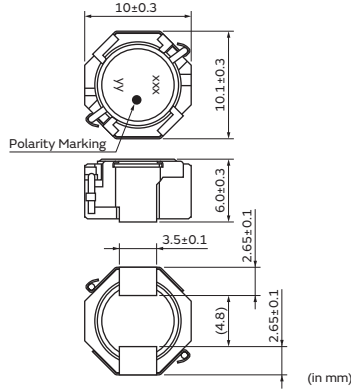

### Packaging

Code	Packaging	Minimum Quantity
=P3	ø330mm Embossed Taping	500

### Rated Value (□: packaging code)

Part Number		Inductance	Inductance Test Frequency	Rated Current (Isat)*	Rated Current (Itemp)*	DC Resistance
Infotainment	Powertrain/Safety					
—	MDH10060C-4R7NA□	4.7μH ±30%	0.1MHz	5900mA	4900mA	0.010Ω±30%
—	MDH10060C-6R8NA□	6.8μH ±30%	0.1MHz	5000mA	4300mA	0.013Ω±30%
—	MDH10060C-100MA□	10μH ±20%	0.1MHz	4100mA	3800mA	0.017Ω±30%
—	MDH10060C-150MA□	15μH ±20%	0.1MHz	3400mA	3100mA	0.027Ω±30%
—	MDH10060C-220MA□	22μH ±20%	0.1MHz	2800mA	2700mA	0.040Ω±30%
—	MDH10060C-330MA□	33μH ±20%	0.1MHz	2200mA	2200mA	0.061Ω±30%
—	MDH10060C-470MA□	47μH ±20%	0.1MHz	1900mA	2000mA	0.074Ω±30%
—	MDH10060C-680MA□	68μH ±20%	0.1MHz	1600mA	1700mA	0.091Ω±30%
—	MDH10060C-101MA□	100μH ±20%	0.1MHz	1300mA	1300mA	0.150Ω±30%
—	MDH10060C-151MA□	150μH ±20%	0.1MHz	1000mA	1000mA	0.240Ω±30%
—	MDH10060C-221MA□	220μH ±20%	0.1MHz	880mA	880mA	0.350Ω±30%
—	MDH10060C-331MA□	330μH ±20%	0.1MHz	720mA	720mA	0.480Ω±30%
—	MDH10060C-471MA□	470μH ±20%	0.1MHz	560mA	560mA	0.750Ω±30%

Operating temp.range (Self-temp.rise included): -55 to 150°C

Inductance:

Measured with an LCR meter 4284A (Keysight) or equivalent.

RDC:

Measured with a Digital Multimeter TR6871 (Advantest) or equivalent.

Only for reflow soldering

\*Isat: Rated Current based on Inductance change

\*Itemp: Rated Current based on Temperature rise

The saturation allowable DC current value is specified when the decrease of the nominal Inductance value at 30%.(The ambient reference temperature is 20°C)

Rated Current (Based on Temperature rise) is specified when temperature of the inductor on our PCB for test purpose is raised 40°C by DC current.(The ambient reference temperature is 20°C)

Class of Magnetic Shield: Ferrite Core

### Inductance-Current Characteristics (Typ.)

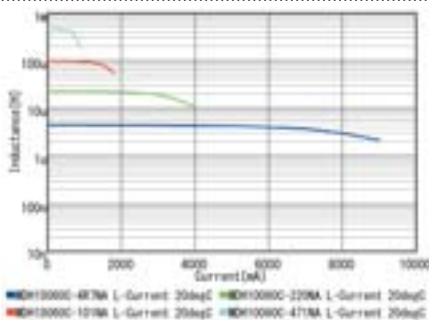

### Temperature Rise Characteristics (Typ.)

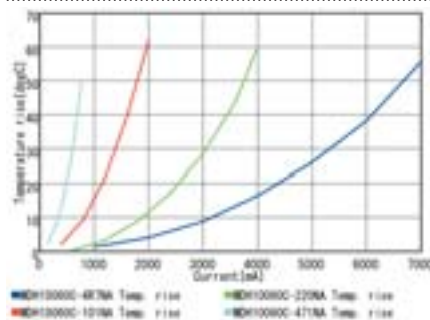

### Inductance-Frequency Characteristics (Typ.)

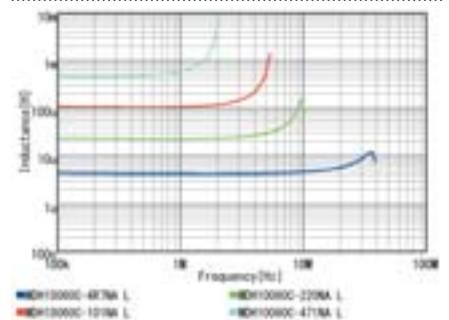

Continued on the following page. ↗

Continued from the preceding page. ↘

### Notice (Rating)

Max. current (DC, AC) as function of ambient temperature  
(derating curve).

Derating of Rated Current



## Inductors for Power Lines

# MBH10145C Series 4141 (104104) inch (mm)

### Appearance/Dimensions

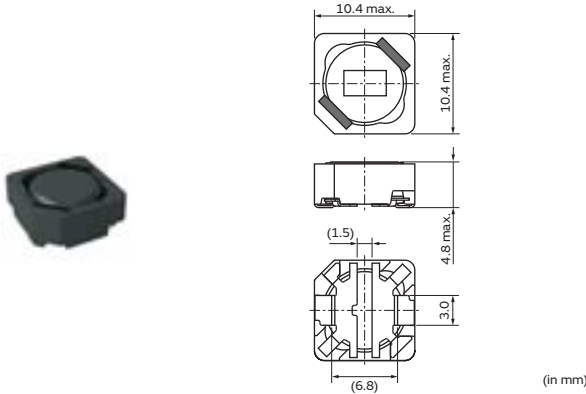

### Packaging

Code	Packaging	Minimum Quantity
=P3	ø330mm Embossed Taping	500

### Rated Value (□: packaging code)

Part Number		Inductance	Inductance Test Frequency	Rated Current (Isat)*	Rated Current (Itemp)*	DC Resistance
Infotainment	Powertrain/Safety					
—	MBH10145C-3R3NA□	3.3μH ±30%	0.1MHz	4900mA	4300mA	0.017Ω±20%
—	MBH10145C-5R6NA□	5.6μH ±30%	0.1MHz	4100mA	3700mA	0.022Ω±20%
—	MBH10145C-100MA□	10μH ±20%	0.1MHz	3100mA	3000mA	0.037Ω±20%
—	MBH10145C-150MA□	15μH ±20%	0.1MHz	2600mA	2500mA	0.048Ω±20%
—	MBH10145C-220MA□	22μH ±20%	0.1MHz	2200mA	2300mA	0.060Ω±20%
—	MBH10145C-330MA□	33μH ±20%	0.1MHz	1700mA	2100mA	0.082Ω±20%
—	MBH10145C-470MA□	47μH ±20%	0.1MHz	1600mA	1700mA	0.100Ω±20%
—	MBH10145C-680MA□	68μH ±20%	0.1MHz	1200mA	1500mA	0.140Ω±20%
—	MBH10145C-101MA□	100μH ±20%	0.1MHz	980mA	1200mA	0.200Ω±20%
—	MBH10145C-151MA□	150μH ±20%	0.1MHz	750mA	930mA	0.350Ω±20%
—	MBH10145C-221MA□	220μH ±20%	0.1MHz	680mA	850mA	0.470Ω±20%
—	MBH10145C-331MA□	330μH ±20%	0.1MHz	560mA	730mA	0.680Ω±20%
—	MBH10145C-471MA□	470μH ±20%	0.1MHz	450mA	560mA	1.030Ω±20%
—	MBH10145C-681MA□	680μH ±20%	0.1MHz	380mA	480mA	1.600Ω±20%
—	MBH10145C-102MA□	1000μH ±20%	0.1MHz	300mA	350mA	2.800Ω±20%
—	MBH10145C-152MA□	1500μH ±20%	0.1MHz	260mA	330mA	3.400Ω±20%

Operating temp.range (Self-temp.rise included): -40 to 150°C

Inductance:

Measured with an LCR meter 4284A (Keysight) or equivalent.

RDC:

Measured with a Digital Multimeter TR6871 (Advantest) or equivalent.

Only for reflow soldering

\*Isat: Rated Current based on Inductance change

\*Itemp: Rated Current based on Temperature rise

Rated current (Isat) is specified when the decrease of the initial inductance value at 10%. (The ambient reference temperature is 25°C)

Rated current (Itemp) is specified when temperature of inductor the is raised 40°C by DC current. (The ambient reference temperature is 25°C)

Class of Magnetic Shield: Ferrite Core

Continued on the following page. ↗

Continued from the preceding page. ↘

**Inductance-Current Characteristics (Typ.)**

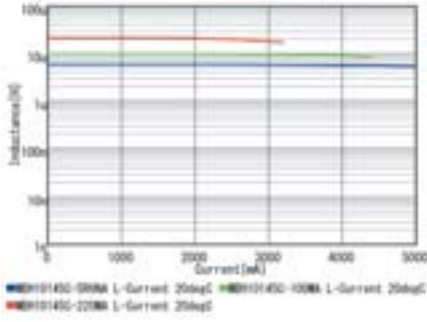

**Temperature Rise Characteristics (Typ.)**

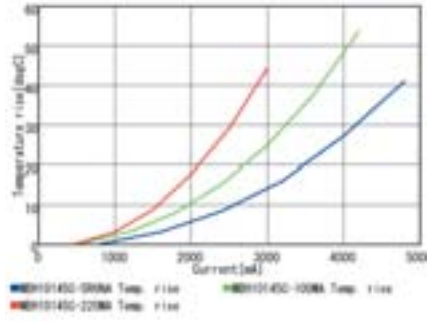

**Inductance-Frequency Characteristics (Typ.)**

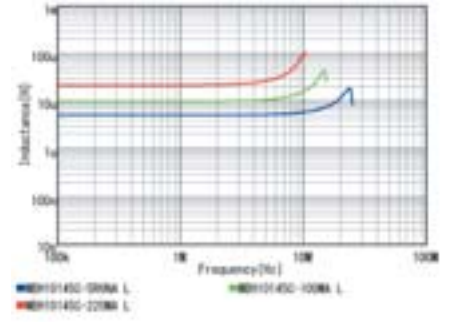

**Notice (Rating)**

Max. current (DC, AC) as function of ambient temperature (derating curve).

Derating of Rated Current

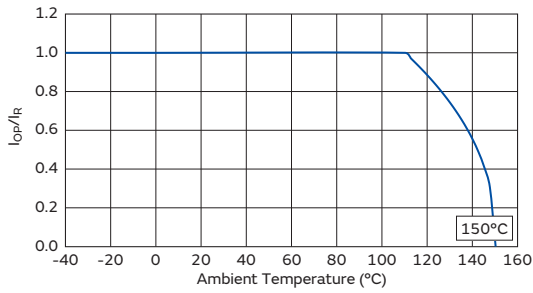

## Inductors for Power Lines

# MBH12282C Series 4949 (125125) inch (mm)

### Appearance/Dimensions

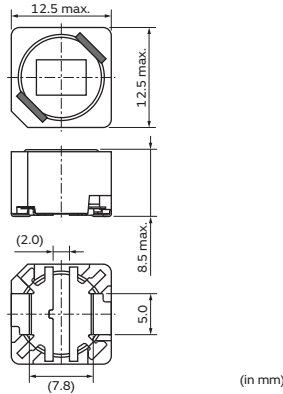

### Packaging

Code	Packaging	Minimum Quantity
=P3	ø330mm Embossed Taping	300

### Rated Value (□: packaging code)

Part Number		Inductance	Inductance Test Frequency	Rated Current (Isat)*	Rated Current (Itemp)*	DC Resistance
Infotainment	Powertrain/Safety					
—	MBH12282C-2RONA□	2.0μH ±30%	0.1MHz	1300mA	730mA	0.0091Ω±20%
—	MBH12282C-3R9NA□	3.9μH ±30%	0.1MHz	910mA	620mA	0.012Ω±20%
—	MBH12282C-4R7NA□	4.7μH ±30%	0.1MHz	790mA	590mA	0.013Ω±20%
—	MBH12282C-6R8NA□	6.8μH ±30%	0.1MHz	700mA	570mA	0.015Ω±20%
—	MBH12282C-100MA□	10μH ±20%	0.1MHz	570mA	530mA	0.019Ω±20%
—	MBH12282C-150MA□	15μH ±20%	0.1MHz	440mA	470mA	0.021Ω±20%
—	MBH12282C-220MA□	22μH ±20%	0.1MHz	380mA	400mA	0.029Ω±20%
—	MBH12282C-330MA□	33μH ±20%	0.1MHz	300mA	300mA	0.047Ω±20%
—	MBH12282C-470MA□	47μH ±20%	0.1MHz	250mA	260mA	0.066Ω±20%
—	MBH12282C-680MA□	68μH ±20%	0.1MHz	210mA	220mA	0.083Ω±20%
—	MBH12282C-820MA□	82μH ±20%	0.1MHz	190mA	220mA	0.091Ω±20%
—	MBH12282C-101MA□	100μH ±20%	0.1MHz	170mA	190mA	0.110Ω±20%
—	MBH12282C-151MA□	150μH ±20%	0.1MHz	140mA	160mA	0.160Ω±20%
—	MBH12282C-221MA□	220μH ±20%	0.1MHz	110mA	120mA	0.250Ω±20%
—	MBH12282C-331MA□	330μH ±20%	0.1MHz	90mA	110mA	0.350Ω±20%
—	MBH12282C-471MA□	470μH ±20%	0.1MHz	84mA	93mA	0.460Ω±20%
—	MBH12282C-681MA□	680μH ±20%	0.1MHz	66mA	76mA	0.720Ω±20%
—	MBH12282C-102MA□	1000μH ±20%	0.1MHz	56mA	59mA	1.050Ω±20%

Operating temp.range (Self-temp.rise included): -40 to 150°C

Inductance:

Measured with an LCR meter 4284A (Keysight) or equivalent.

RDC:

Measured with a Digital Multimeter TR6871 (Advantest) or equivalent.

Only for reflow soldering

\*Isat: Rated Current based on Inductance change

\*Itemp: Rated Current based on Temperature rise

Rated current (Isat) is specified when the decrease of the initial inductance value at 10%. (The ambient reference temperature is 25°C)

Rated current (Itemp) is specified when temperature of inductor the is raised 40°C by DC current. (The ambient reference temperature is 25°C)

Class of Magnetic Shield: Ferrite Core

Continued on the following page. ↗

Continued from the preceding page. ↘

**Inductance-Current Characteristics (Typ.)**

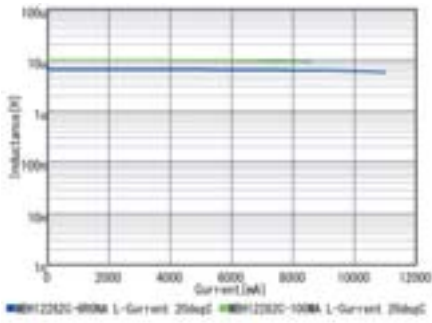

**Temperature Rise Characteristics (Typ.)**

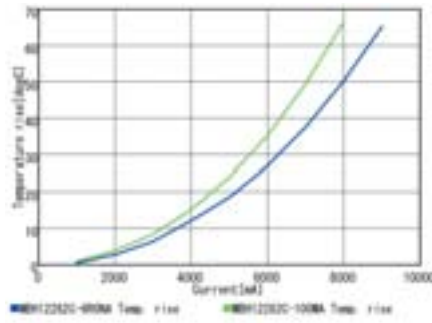

**Inductance-Frequency Characteristics (Typ.)**

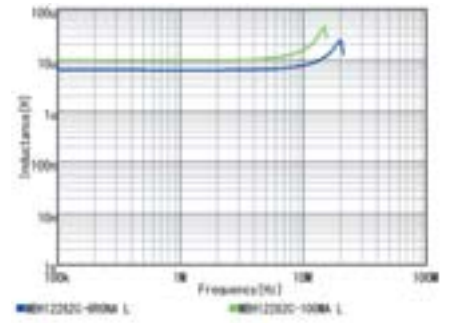

**Notice (Rating)**

Max. current (DC, AC) as function of ambient temperature (derating curve).

Derating of Rated Current





## Inductors for Power Lines

# MDH12577C Series 5049 (128125) inch (mm)

### Appearance/Dimensions

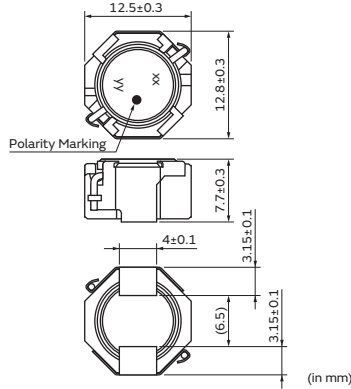

### Packaging

Code	Packaging	Minimum Quantity
=P3	ø330mm Embossed Taping	300

### Rated Value (□: packaging code)

Part Number		Inductance	Inductance Test Frequency	Rated Current (Isat)*	Rated Current (Itemp)*	DC Resistance
Infotainment	Powertrain/Safety					
—	MDH12577C-4R7NA□	4.7μH ±30%	0.1MHz	1100mA	5400mA	0.009Ω±30%
—	MDH12577C-6R8NA□	6.8μH ±30%	0.1MHz	8600mA	4800mA	0.012Ω±30%
—	MDH12577C-100MA□	10μH ±20%	0.1MHz	7700mA	4700mA	0.014Ω±30%
—	MDH12577C-150MA□	15μH ±20%	0.1MHz	5700mA	3600mA	0.022Ω±30%
—	MDH12577C-220MA□	22μH ±20%	0.1MHz	4900mA	3000mA	0.033Ω±30%
—	MDH12577C-330MA□	33μH ±20%	0.1MHz	4000mA	2700mA	0.039Ω±30%
—	MDH12577C-470MA□	47μH ±20%	0.1MHz	3400mA	2100mA	0.066Ω±30%
—	MDH12577C-680MA□	68μH ±20%	0.1MHz	2800mA	1800mA	0.090Ω±30%
—	MDH12577C-101MA□	100μH ±20%	0.1MHz	2300mA	1600mA	0.108Ω±30%
—	MDH12577C-151MA□	150μH ±20%	0.1MHz	1900mA	1400mA	0.17Ω±30%
—	MDH12577C-221MA□	220μH ±20%	0.1MHz	1500mA	1100mA	0.25Ω±30%
—	MDH12577C-331MA□	330μH ±20%	0.1MHz	1300mA	900mA	0.41Ω±30%
—	MDH12577C-471MA□	470μH ±20%	0.1MHz	1000mA	700mA	0.54Ω±30%

Operating temp.range (Self-temp.rise included): -55 to 150°C

Inductance:

Measured with an LCR meter 4284A (Keysight) or equivalent.

RDC:

Measured with a Digital Multimeter TR6871 (Advantest) or equivalent.

Only for reflow soldering

\*Isat: Rated Current based on Inductance change

\*Itemp: Rated Current based on Temperature rise

The saturation allowable DC current value is specified when the decrease of the nominal Inductance value at 30%.(The ambient reference temperature is 20°C)

Rated Current (Based on Temperature rise) is specified when temperature of the inductor on our PCB for test purpose is raised 40°C by DC current.(The ambient reference temperature is 20°C)

Class of Magnetic Shield: Ferrite Core

### Inductance-Current Characteristics (Typ.)

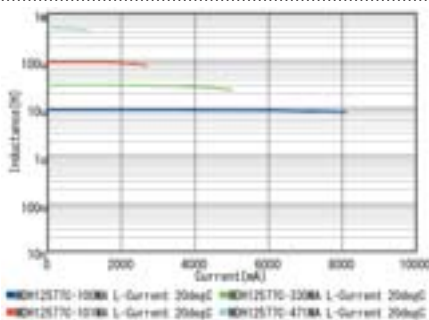

### Temperature Rise Characteristics (Typ.)

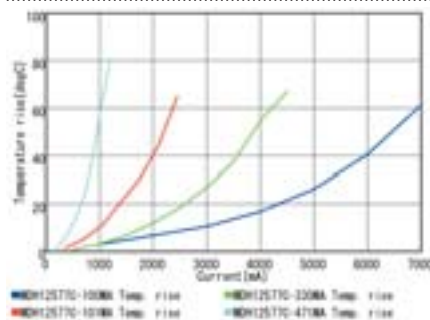

### Inductance-Frequency Characteristics (Typ.)

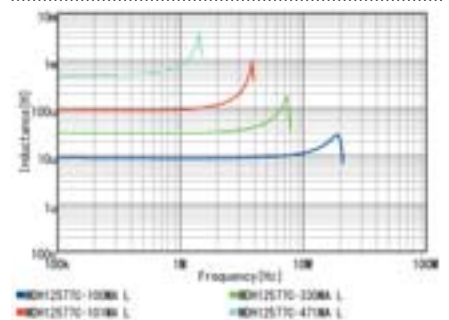

Continued on the following page. ↗

Continued from the preceding page. ↘

### Notice (Rating)

Max. current (DC, AC) as function of ambient temperature  
(derating curve).

Derating of Rated Current

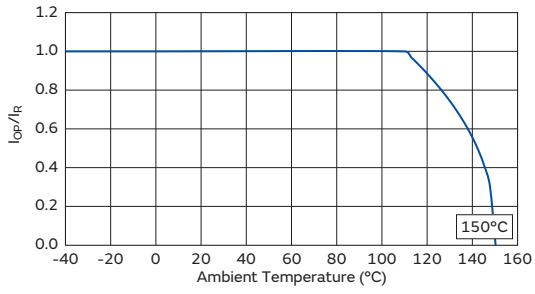

Inductors for Power Lines

Inductors for General Circuits

RF Inductors

## Inductors for Power Lines

# MBH12575C Series 5050 (128128) inch (mm)

### Appearance/Dimensions

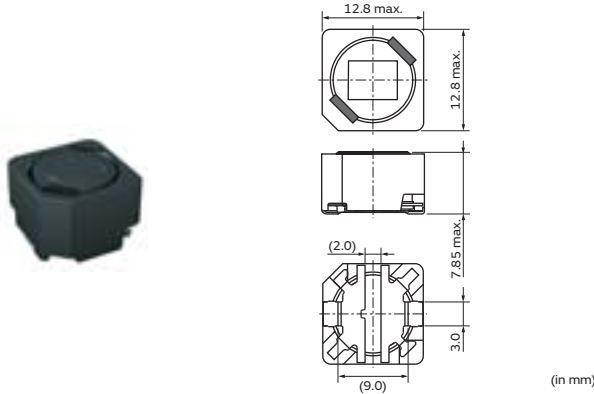

### Packaging

Code	Packaging	Minimum Quantity
=P3	ø330mm Embossed Taping	300

### Rated Value (□: packaging code)

Part Number		Inductance	Inductance Test Frequency	Rated Current (Isat)*	Rated Current (Itemp)*	DC Resistance
Infotainment	Powertrain/Safety					
—	MBH12575C-2R7NA□	2.7μH ±30%	0.1MHz	1000mA	7100mA	0.010Ω±20%
—	MBH12575C-3R9NA□	3.9μH ±30%	0.1MHz	8000mA	6500mA	0.011Ω±20%
—	MBH12575C-5R6NA□	5.6μH ±30%	0.1MHz	7000mA	6000mA	0.012Ω±20%
—	MBH12575C-6R8NA□	6.8μH ±30%	0.1MHz	5900mA	5600mA	0.014Ω±20%
—	MBH12575C-100MA□	10μH ±20%	0.1MHz	4900mA	5200mA	0.016Ω±20%
—	MBH12575C-150MA□	15μH ±20%	0.1MHz	3800mA	4700mA	0.019Ω±20%
—	MBH12575C-220MA□	22μH ±20%	0.1MHz	3100mA	4000mA	0.027Ω±20%
—	MBH12575C-330MA□	33μH ±20%	0.1MHz	2800mA	3400mA	0.040Ω±20%
—	MBH12575C-470MA□	47μH ±20%	0.1MHz	2100mA	2700mA	0.053Ω±20%
—	MBH12575C-680MA□	68μH ±20%	0.1MHz	1700mA	2100mA	0.077Ω±20%
—	MBH12575C-101MA□	100μH ±20%	0.1MHz	1500mA	1700mA	0.120Ω±20%
—	MBH12575C-151MA□	150μH ±20%	0.1MHz	1300mA	1400mA	0.170Ω±20%
—	MBH12575C-221MA□	220μH ±20%	0.1MHz	1000mA	1200mA	0.250Ω±20%

Operating temp.range (Self-temp.rise included): -40 to 150°C

Inductance:

Measured with an LCR meter 4284A (Keysight) or equivalent.

RDC:

Measured with a Digital Multimeter TR6871 (Advantest) or equivalent.

Only for reflow soldering

\*Isat: Rated Current based on Inductance change

\*Itemp: Rated Current based on Temperature rise

Rated current (Isat) is specified when the decrease of the initial inductance value at 10%. (The ambient reference temperature is 25°C)

Rated current (Itemp) is specified when temperature of inductor the is raised 40°C by DC current. (The ambient reference temperature is 25°C)

Class of Magnetic Shield: Ferrite Core

### Inductance-Current Characteristics (Typ.)

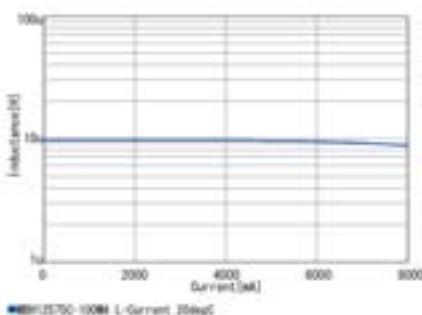

### Temperature Rise Characteristics (Typ.)

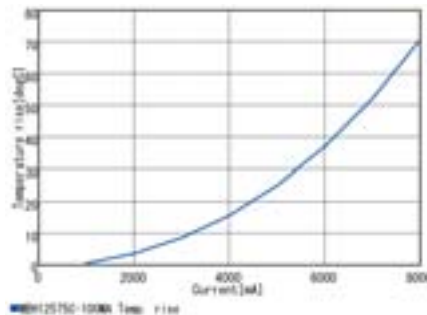

### Inductance-Frequency Characteristics (Typ.)

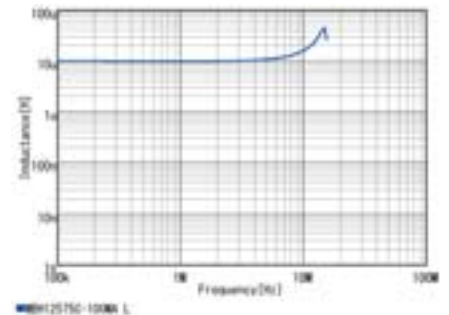

Continued on the following page. ↗

Continued from the preceding page. ↘

### Notice (Rating)

Max. current (DC, AC) as function of ambient temperature  
(derating curve).

Derating of Rated Current



# Inductors for Power Lines

## LQM18PZ\_CH Series 0603 (1608) inch (mm)

### Appearance/Dimensions

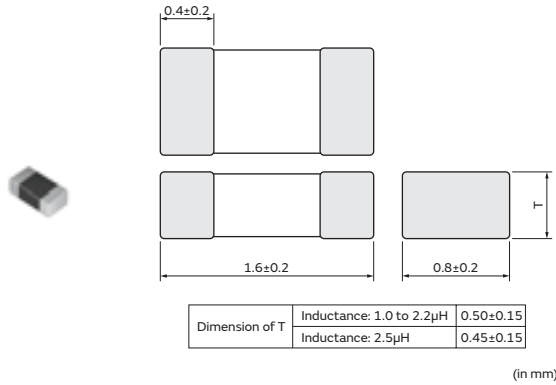

### Packaging

Code	Packaging	Minimum Quantity
D	ø180mm Paper Taping	4000
B	Packing in Bulk	1000

### Rated Value (□: packaging code)

Part Number		Inductance	Inductance Test Frequency	Rated Current (Isat)*	Rated Current (Itemp)*	Max. of DC Resistance	S.R.F.* (min.)
Infotainment	Powertrain/Safety						
LQM18PZ1R0MCH□	—	1.0μH ±20%	1MHz	600mA	950mA(Ambient temp.85°C) 650mA(Ambient temp.125°C)	0.29Ω	80MHz
LQM18PZ2R2MCH□	—	2.2μH ±20%	1MHz	200mA	750mA(Ambient temp.85°C) 500mA(Ambient temp.125°C)	0.48Ω	50MHz
LQM18PZ2R5NCH□	—	2.5μH ±30%	1MHz	100mA	900mA(Ambient temp.85°C) 640mA(Ambient temp.125°C)	0.30Ω	50MHz

Operating temp.range: -55 to 125°C

Class of Magnetic Shield: Ferrite Core

Only for reflow soldering

\*Isat: Rated Current based on Inductance change

\*Itemp: Rated Current based on Temperature rise

\*S.R.F: Self Resonant Frequency

In operating temperatures exceeding +85°C, derating of current is necessary for the LQM18PZ\_CH series. Please apply the derating curve shown in the chart according to the operating temperature. Please consider "Notice (Rating)." When rated current is applied to the products, Inductance will be within ±30% of initial Inductance value range. When rated current is applied to the products, the temperature rise caused by self-generated heat shall be limited to 40°Cmax.

### Inductance-Frequency Characteristics (Typ.)

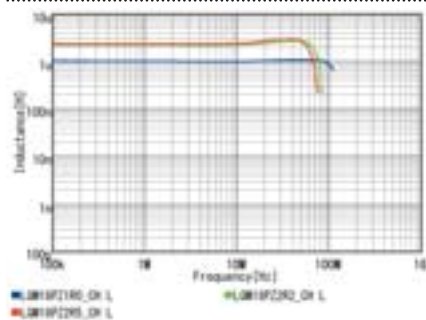

### Inductance-Current Characteristics (Typ.)

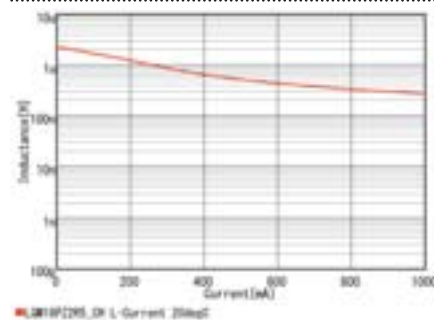

### Temperature Rise Characteristics (Typ.)

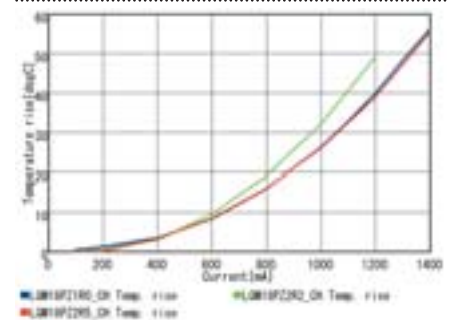

Continued on the following page. ↗

Continued from the preceding page. ↘

### Notice (Rating)

In operating temperatures exceeding +85°C, derating of current is necessary for this series.  
Please apply the derating curve shown in the chart according to the operating temperature.

#### Derating of Rated Current



## Inductors for Power Lines

# LQM18PZ\_DH Series 0603 (1608) inch (mm)

### Appearance/Dimensions

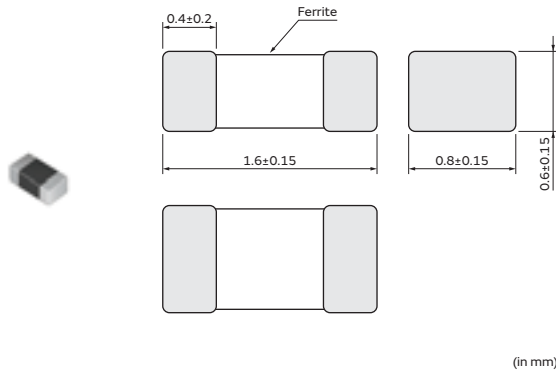

### Packaging

Code	Packaging	Minimum Quantity
D	ø180mm Paper Taping	4000
B	Packing in Bulk	1000

### Rated Value (□: packaging code)

Part Number		Inductance	Inductance Test Frequency	Rated Current (Isat)*	Rated Current (Itemp)*	Max. of DC Resistance	S.R.F* (min.)
Infotainment	Powertrain/Safety						
LQM18PZ2R2MDH□	—	2.2μH ±20%	1MHz	250mA	650mA(Ambient temp.85°C) 450mA(Ambient temp.125°C)	0.47Ω	80MHz

Operating temp.range: -55 to 125°C

Class of Magnetic Shield: Ferrite Core

Only for reflow soldering

\*Isat: Rated Current based on Inductance change

\*Itemp: Rated Current based on Temperature rise

\*S.R.F: Self Resonant Frequency

In operating temperatures exceeding +85°C, derating of current is necessary for the LQM18PZ\_DH series. Please apply the derating curve shown in the chart according to the operating temperature. Please consider "Notice (Rating)." When rated current is applied to the products, Inductance will be within ±30% of initial Inductance value range. When rated current is applied to the products, the temperature rise caused by self-generated heat shall be limited to 40°Cmax.

### Inductance-Frequency Characteristics (Typ.)

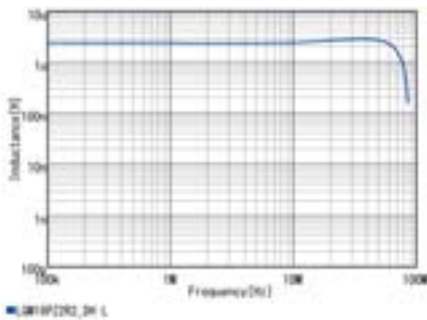

### Inductance-Current Characteristics (Typ.)

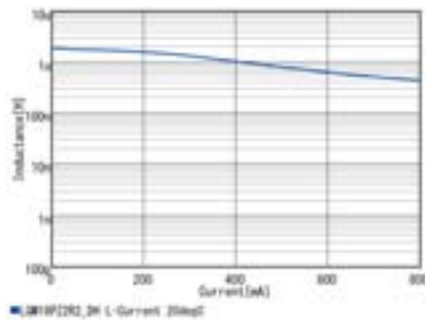

### Temperature Rise Characteristics (Typ.)

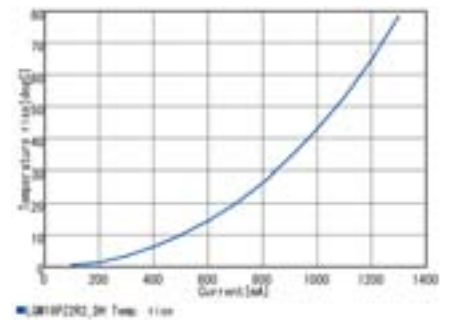

### Notice (Rating)

In operating temperatures exceeding +85°C, derating of current is necessary for this series.

Please apply the derating curve shown in the chart according to the operating temperature.

#### Derating of Rated Current

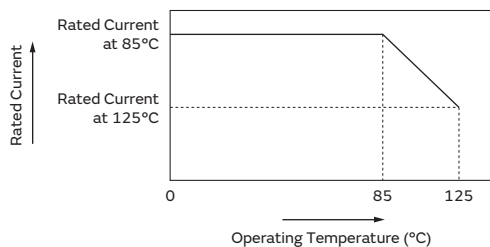

## Inductors for Power Lines

# LQM18PZ\_FH Series 0603 (1608) inch (mm)

### Appearance/Dimensions

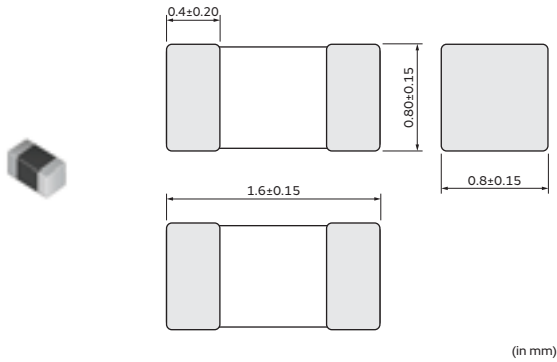

### Packaging

Code	Packaging	Minimum Quantity
D	∅180mm Paper Taping	4000
B	Packing in Bulk	1000

### Rated Value (□: packaging code)

Part Number		Inductance	Inductance Test Frequency	Rated Current (Isat)*	Rated Current (Itemp)*	Max. of DC Resistance	S.R.F* (min.)
Infotainment	Powertrain/Safety						
LQM18PZ2R2MFH□	—	2.2μH ±20%	1MHz	300mA	700mA(Ambient temp.85°C) 500mA(Ambient temp.125°C)	0.47Ω	80MHz

Operating temp.range: -55 to 125°C

Class of Magnetic Shield: Ferrite Core

Only for reflow soldering

\*Isat: Rated Current based on Inductance change

\*Itemp: Rated Current based on Temperature rise

\*S.R.F: Self Resonant Frequency

In operating temperatures exceeding +85°C, derating of current is necessary for the LQM18PZ\_FH series. Please apply the derating curve shown in the chart according to the operating temperature. Please consider "Notice (Rating)." When rated current is applied to the products, Inductance will be within ±30% of initial Inductance value range. When rated current is applied to the products, the temperature rise caused by self-generated heat shall be limited to 40°Cmax.

### Inductance-Frequency Characteristics (Typ.)

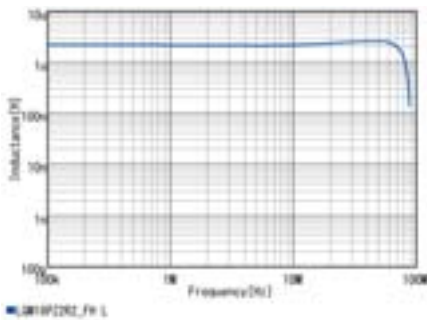

### Inductance-Current Characteristics (Typ.)

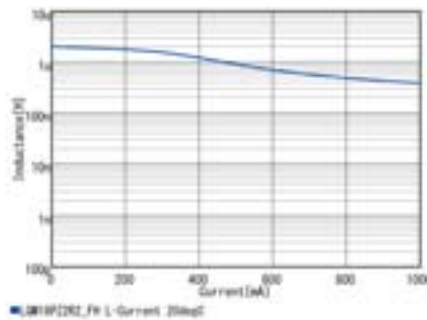

### Temperature Rise Characteristics (Typ.)

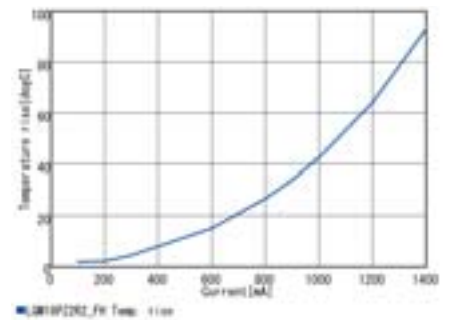

### Notice (Rating)

In operating temperatures exceeding +85°C, derating of current is necessary for this series.

Please apply the derating curve shown in the chart according to the operating temperature.

#### Derating of Rated Current

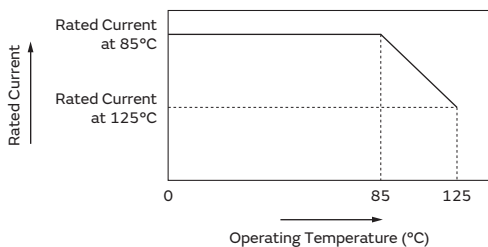



# Inductors for Power Lines

## LQM21PZ\_C0 Series 0805 (2012) inch (mm)

### Appearance/Dimensions

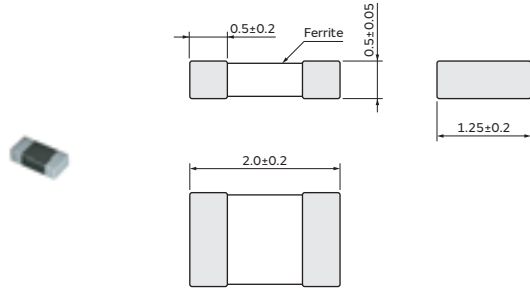

(in mm)

### Packaging

Code	Packaging	Minimum Quantity
D	ø180mm Paper Taping	4000
B	Packing in Bulk	1000

### Rated Value (□: packaging code)

Part Number		Inductance	Inductance Test Frequency	Rated Current	DC Resistance	S.R.F* (min.)
Infotainment	Powertrain/Safety					
LQM21PZR47MC0□	—	0.47μH ±20%	1MHz	1.1A(Ambient temp.85°C) 0.82A(Ambient temp.125°C)	0.12Ω±25%	100MHz
LQM21PZ1R0MC0□	—	1.0μH ±20%	1MHz	0.8A(Ambient temp.85°C) 0.60A(Ambient temp.125°C)	0.19Ω±25%	90MHz
LQM21PZ1R5MC0□	—	1.5μH ±20%	1MHz	0.7A(Ambient temp.85°C) 0.52A(Ambient temp.125°C)	0.26Ω±25%	70MHz
LQM21PZ2R2MC0□	—	2.2μH ±20%	1MHz	0.6A(Ambient temp.85°C) 0.45A(Ambient temp.125°C)	0.34Ω±25%	50MHz

Operating temp.range: -55 to 125°C

Class of Magnetic Shield: Ferrite Core

\*S.R.F: Self Resonant Frequency

In operating temperatures exceeding +85°C, derating of current is necessary for this series. Please apply the derating curve shown in the chart according to the operating temperature. Please consider "Notice (Rating)." When rated current is applied to the products, the temperature rise caused by self-generated heat shall be limited to 40°C max.

### Inductance-Frequency Characteristics (Typ.)

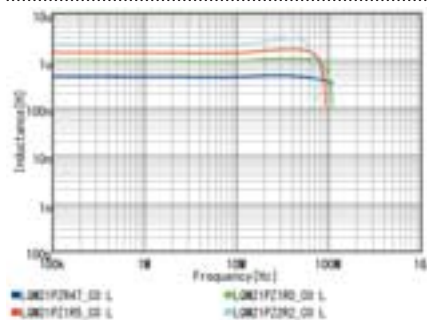

### Inductance-Current Characteristics (Typ.)

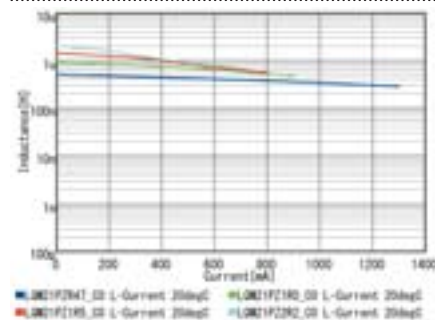

### Temperature Rise Characteristics (Typ.)

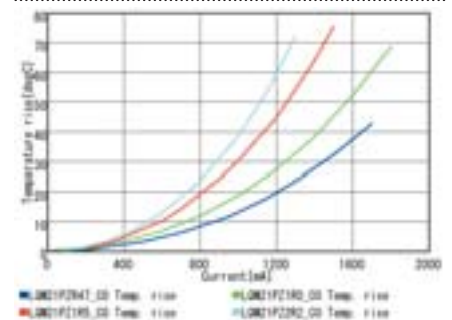

Continued on the following page. ↗

Continued from the preceding page. ↘

### Notice (Rating)

In operating temperatures exceeding +85°C, derating of current is necessary for this series.  
Please apply the derating curve shown in the chart according to the operating temperature.

#### Derating of Rated Current

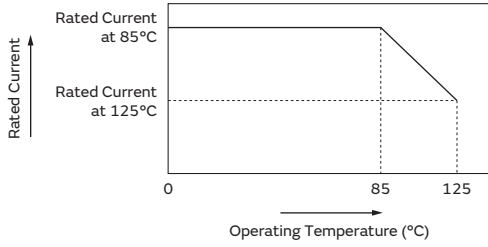

# Inductors for Power Lines

## LQM21PZ\_G0 Series 0805 (2012) inch (mm)

### Appearance/Dimensions

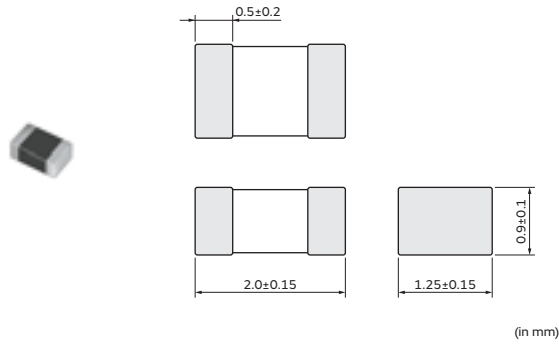

### Packaging

Code	Packaging	Minimum Quantity
D	ø180mm Paper Taping	4000
B	Packing in Bulk	1000

### Rated Value (□: packaging code)

Part Number		Inductance	Inductance Test Frequency	Rated Current	DC Resistance	S.R.F* (min.)
Infotainment	Powertrain/Safety					
LQM21PZR47MG0□	—	0.47μH ±20%	1MHz	1.3A(Ambient temp.85°C) 0.95A(Ambient temp.125°C)	0.075Ω(typ.)	100MHz
LQM21PZR54MG0□	—	0.54μH ±20%	1MHz	1.3A(Ambient temp.85°C) 0.95A(Ambient temp.125°C)	0.075Ω(typ.)	100MHz
LQM21PZ3R3MG0□	—	3.3μH ±20%	1MHz	0.8A(Ambient temp.85°C) 0.55A(Ambient temp.125°C)	0.165Ω(typ.)	30MHz
LQM21PZ3R3NG0□	—	3.3μH ±30%	1MHz	0.8A(Ambient temp.85°C) 0.55A(Ambient temp.125°C)	0.165Ω(typ.)	30MHz

Operating temp.range: -55 to 125°C

Class of Magnetic Shield: Ferrite Core

\*S.R.F: Self Resonant Frequency

In operating temperatures exceeding +85°C, derating of current is necessary for the LQM21P\_G0 series. Please apply the derating curve shown in the chart according to the operating temperature. Please consider "Notice (Rating)." When rated current is applied to the products, the temperature rise caused by self-generated heat shall be limited to 40°C max.

### Inductance-Frequency Characteristics (Typ.)

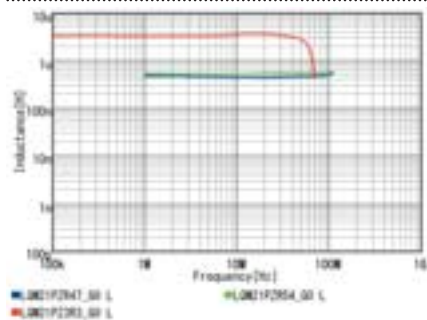

### Inductance-Current Characteristics (Typ.)

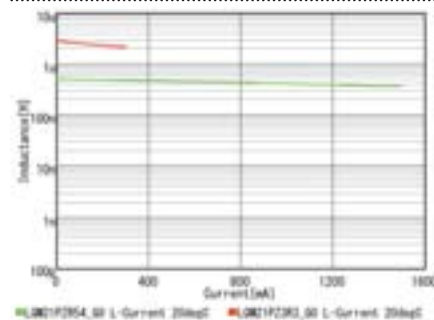

### Temperature Rise Characteristics (Typ.)

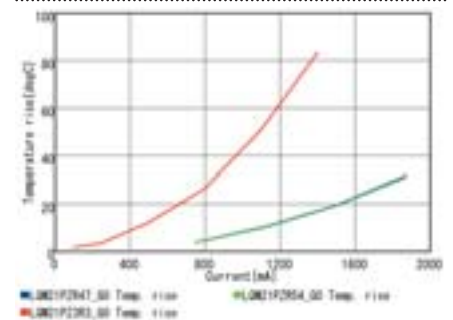

Continued on the following page. ↗

Continued from the preceding page. ↘

### Notice (Rating)

In operating temperatures exceeding +85°C, derating of current is necessary for this series.  
Please apply the derating curve shown in the chart according to the operating temperature.

#### Derating of Rated Current

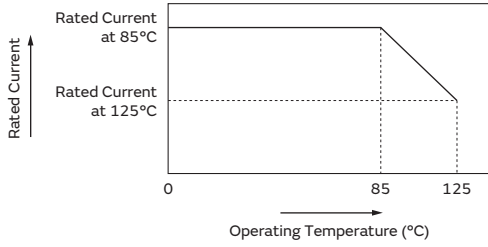

# Inductors for Power Lines

## LQM21PZ\_GC/LQM21PH\_GC Series 0805 (2012) inch (mm)

### Appearance/Dimensions

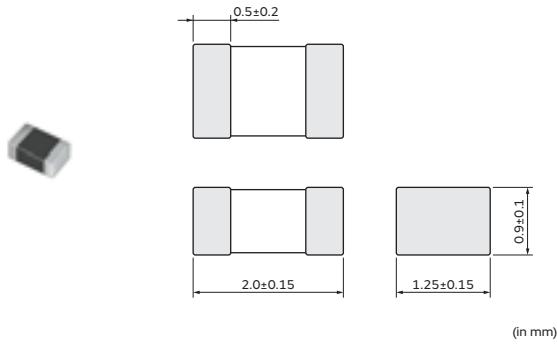

### Packaging

Code	Packaging	Minimum Quantity
D	ø180mm Paper Taping	4000
B	Packing in Bulk	1000

### Rated Value (□: packaging code)

Part Number		Inductance	Inductance Test Frequency	Rated Current	DC Resistance	S.R.F* (min.)
Infotainment	Powertrain/Safety					
LQM21PZ1R0NGC□	—	1.0μH ±30%	1MHz	0.9A(Ambient temp.85°C) 0.65A(Ambient temp.125°C)	0.10Ω±25%	50MHz
—	LQM21PH2R2MGC□	2.2μH ±20%	1MHz	0.8A(Ambient temp.85°C) 0.6A(Ambient temp.125°C)	0.23Ω±25%	40MHz
LQM21PZ2R2NGC□	LQM21PH2R2NGC□	2.2μH ±30%	1MHz	0.8A(Ambient temp.85°C) 0.6A(Ambient temp.125°C)	0.23Ω±25%	40MHz

Operating temp.range: -55 to 125°C

Class of Magnetic Shield: Ferrite Core

\*S.R.F: Self Resonant Frequency

In operating temperatures exceeding +85°C, derating of current is necessary for the LQM21P\_GC series. Please apply the derating curve shown in the chart according to the operating temperature. Please consider "Notice (Rating)." When rated current is applied to the products, the temperature rise caused by self-generated heat shall be limited to 40°C max.

### Inductance-Frequency Characteristics (Typ.)

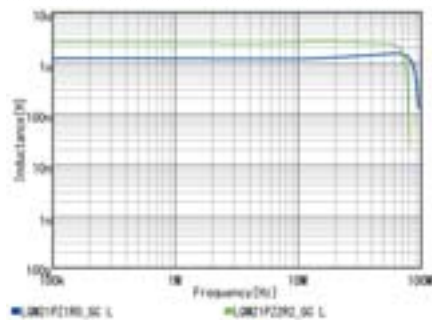

### Inductance-Current Characteristics (Typ.)

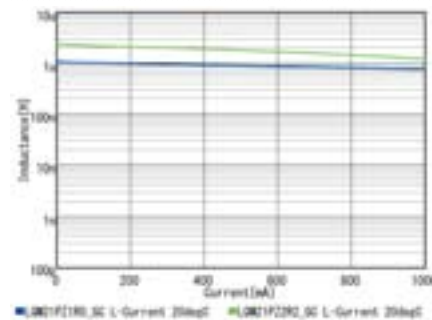

### Temperature Rise Characteristics (Typ.)

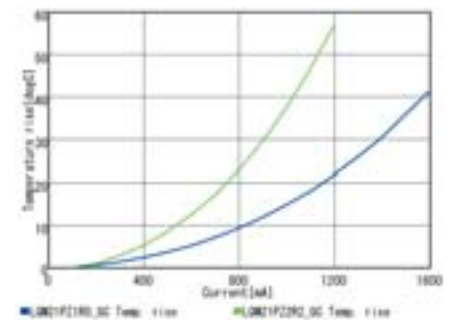

Continued on the following page. ↗

Continued from the preceding page. ↘

### Notice (Rating)

In operating temperatures exceeding +85°C, derating of current is necessary for this series.  
Please apply the derating curve shown in the chart according to the operating temperature.

#### Derating of Rated Current



# Inductors for Power Lines

## LQM21PZ\_GR Series 0805 (2012) inch (mm)

### Appearance/Dimensions

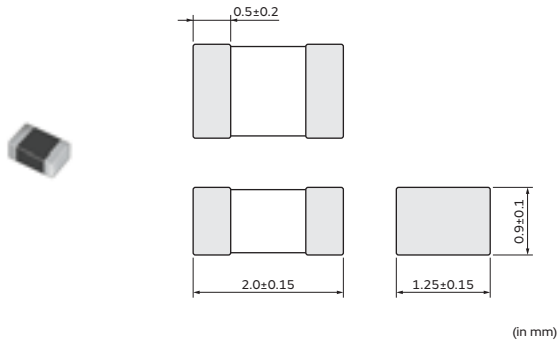

### Packaging

Code	Packaging	Minimum Quantity
D	ø180mm Paper Taping	4000
B	Packing in Bulk	1000

### Rated Value (□: packaging code)

Part Number		Inductance	Inductance Test Frequency	Rated Current	DC Resistance	S.R.F* (min.)
Infotainment	Powertrain/Safety					
LQM21PZ1R0NGR□	—	1.0μH ±30%	1MHz	1.3A(Ambient temp.85°C) 0.95A(Ambient temp.125°C)	0.066Ω±25%	50MHz
LQM21PZ3R3MGR□	—	3.3μH ±20%	1MHz	1.0A(Ambient temp.85°C) 0.75A(Ambient temp.125°C)	0.15Ω±25%	30MHz
LQM21PZ3R3NGR□	—	3.3μH ±30%	1MHz	1.0A(Ambient temp.85°C) 0.75A(Ambient temp.125°C)	0.15Ω±25%	30MHz
LQM21PZ4R7MGR□	—	4.7μH ±20%	1MHz	0.8A(Ambient temp.85°C) 0.6A(Ambient temp.125°C)	0.23Ω±25%	30MHz
LQM21PZ4R7NGR□	—	4.7μH ±30%	1MHz	0.8A(Ambient temp.85°C) 0.6A(Ambient temp.125°C)	0.23Ω±25%	30MHz

Operating temp.range: -55 to 125°C

Class of Magnetic Shield: Ferrite Core

\*S.R.F: Self Resonant Frequency

In operating temperatures exceeding +85°C, derating of current is necessary for this series. Please apply the derating curve shown in the chart according to the operating temperature. Please consider "Notice (Rating)." When rated current is applied to the products, the temperature rise caused by self-generated heat shall be limited to 40°C max.

### Inductance-Frequency Characteristics (Typ.)

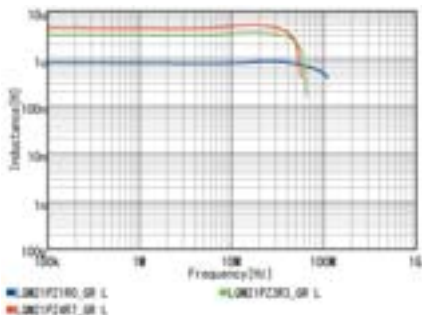

### Inductance-Current Characteristics (Typ.)

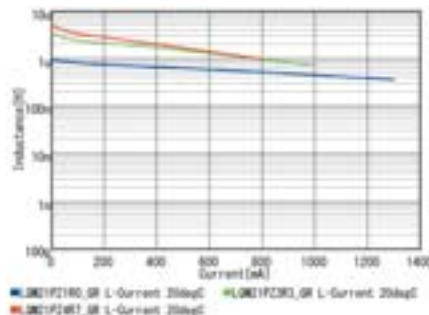

### Temperature Rise Characteristics (Typ.)

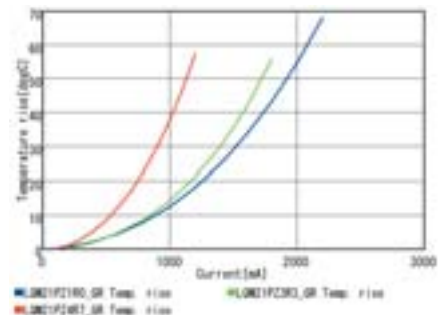

Continued on the following page. ↗

Continued from the preceding page. ↘

### Notice (Rating)

In operating temperatures exceeding +85°C, derating of current is necessary for this series.  
Please apply the derating curve shown in the chart according to the operating temperature.

#### Derating of Rated Current

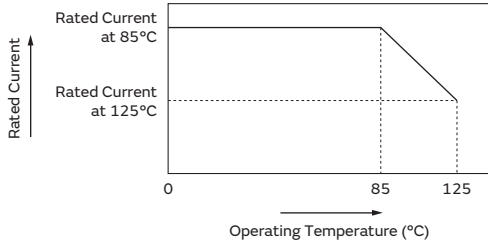



## Inductors for Power Lines

# LQM2MPZ\_GO Series 0806 (2016) inch (mm)

### Appearance/Dimensions

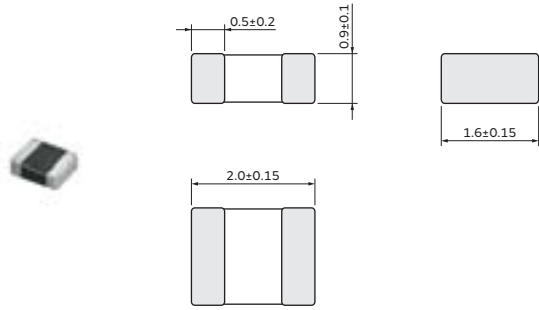

(in mm)

### Packaging

Code	Packaging	Minimum Quantity
L	ø180mm Embossed Taping	3000
B	Packing in Bulk	1000

### Rated Value (□: packaging code)

Part Number		Inductance	Inductance Test Frequency	Rated Current	DC Resistance	S.R.F* (min.)
Infotainment	Powertrain/Safety					
LQM2MPZR47MG0□	—	0.47μH ±20%	1MHz	1.6A(Ambient temp.85°C) 1.2A(Ambient temp.125°C)	0.060Ω(typ.)	100MHz
LQM2MPZR47NG0□	—	0.47μH ±30%	1MHz	1.6A(Ambient temp.85°C) 1.2A(Ambient temp.125°C)	0.060Ω(typ.)	100MHz
LQM2MPZ1R0NG0□	—	1.0μH ±30%	1MHz	1.4A(Ambient temp.85°C) 1.0A(Ambient temp.125°C)	0.085Ω(typ.)	60MHz
LQM2MPZ1R5MG0□	—	1.5μH ±20%	1MHz	1.2A(Ambient temp.85°C) 0.9A(Ambient temp.125°C)	0.11Ω(typ.)	50MHz
LQM2MPZ1R5NG0□	—	1.5μH ±30%	1MHz	1.2A(Ambient temp.85°C) 0.9A(Ambient temp.125°C)	0.11Ω(typ.)	50MHz
LQM2MPZ2R2MG0□	—	2.2μH ±20%	1MHz	1.2A(Ambient temp.85°C) 0.9A(Ambient temp.125°C)	0.11Ω(typ.)	40MHz
LQM2MPZ2R2NG0□	—	2.2μH ±30%	1MHz	1.2A(Ambient temp.85°C) 0.9A(Ambient temp.125°C)	0.11Ω(typ.)	40MHz
LQM2MPZ3R3NG0□	—	3.3μH ±30%	1MHz	1.2A(Ambient temp.85°C) 0.9A(Ambient temp.125°C)	0.12Ω(typ.)	30MHz
LQM2MPZ4R7MG0□	—	4.7μH ±20%	1MHz	1.1A(Ambient temp.85°C) 0.8A(Ambient temp.125°C)	0.14Ω(typ.)	20MHz
LQM2MPZ4R7NG0□	—	4.7μH ±30%	1MHz	1.1A(Ambient temp.85°C) 0.8A(Ambient temp.125°C)	0.14Ω(typ.)	20MHz

Operating temp.range: -55 to 125°C

Class of Magnetic Shield: Ferrite Core

\*S.R.F: Self Resonant Frequency

In operating temperatures exceeding +85°C, derating of current is necessary for the LQM2MPN\_GO series. Please apply the derating curve shown in the chart according to the operating temperature. Please consider "Notice (Rating)." When rated current is applied to the products, the temperature rise caused by self-generated heat shall be limited to 40°C max.

Continued on the following page. ↗

Continued from the preceding page. ↘

**Inductance-Frequency Characteristics (Typ.)**

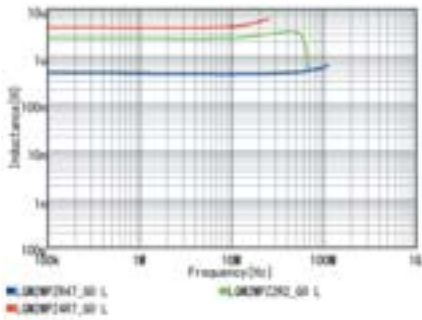

**Inductance-Current Characteristics (Typ.)**

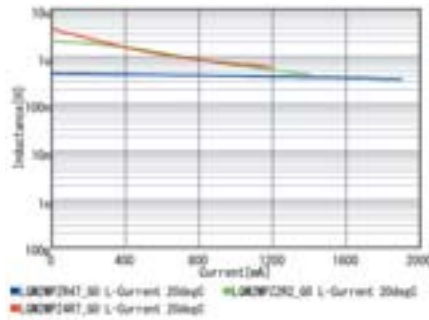

**Temperature Rise Characteristics (Typ.)**

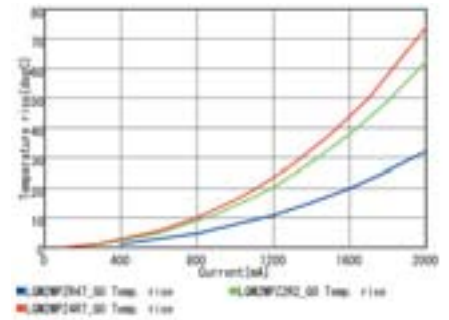

**Notice (Rating)**

In operating temperatures exceeding +85°C, derating of current is necessary for this series. Please apply the derating curve shown in the chart according to the operating temperature.

**Derating of Rated Current**

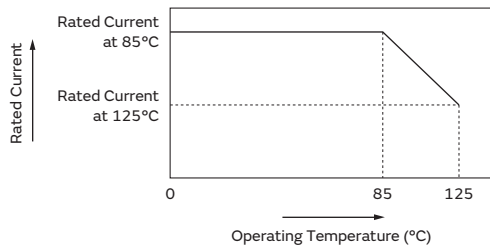

# Inductors for Power Lines

## LQM2MPZ\_JH Series 0806 (2016) inch (mm)

### Appearance/Dimensions

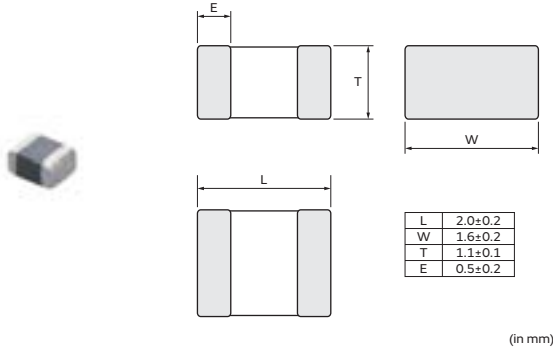

### Packaging

Code	Packaging	Minimum Quantity
L	ø180mm Embossed Taping	3000
B	Packing in Bulk	1000

### Rated Value (□: packaging code)

Part Number		Inductance	Inductance Test Frequency	Rated Current (Isat)*	Rated Current (Itemp)*	Max. of DC Resistance	S.R.F* (min.)
Infotainment	Powertrain/Safety						
LQM2MPZR10MJH□	—	0.1μH ±20%	1MHz	4000mA	4000mA(Ambient temp.85°C) 3000mA(Ambient temp.125°C)	0.019Ω	200MHz

Operating temp.range: -55 to 125°C  
 Class of Magnetic Shield: Ferrite Core

\*Isat: Rated Current based on Inductance change

\*Itemp: Rated Current based on Temperature rise

\*S.R.F: Self Resonant Frequency

In operating temperatures exceeding +85°C, derating of current is necessary for the LQM2MPZ\_JH series. Please apply the derating curve shown in the chart according to the operating temperature. Please consider "Notice (Rating)." When rated current is applied to the products, inductance will be within ±30% of initial inductance value range. When rated current is applied to the products, the temperature rise caused by self-generated heat shall be limited to 40°Cmax.

### Inductance-Frequency Characteristics (Typ.)

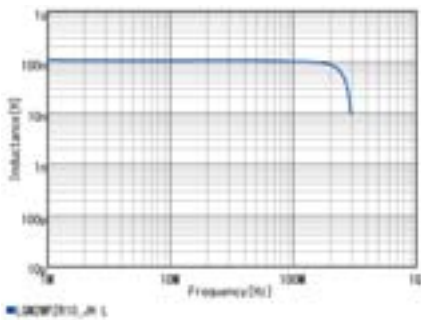

### Inductance-Current Characteristics (Typ.)

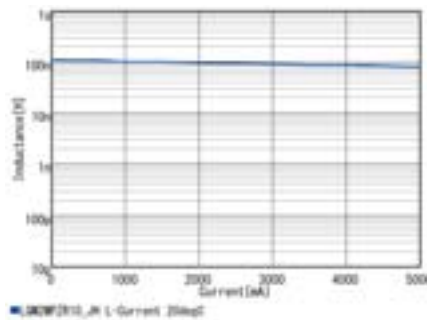

### Temperature Rise Characteristics (Typ.)

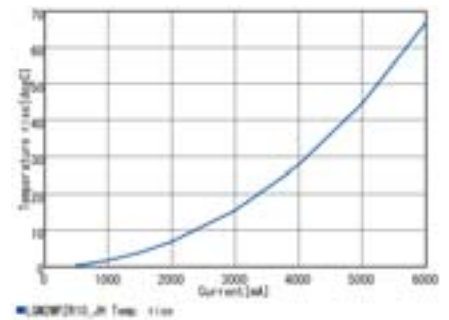

### Notice (Rating)

In operating temperatures exceeding +85°C, derating of current is necessary for this series.

Please apply the derating curve shown in the chart according to the operating temperature.

#### Derating of Rated Current

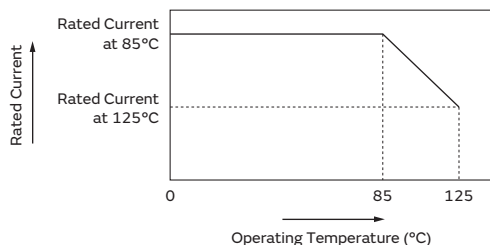

## Inductors for Power Lines

# LQM2HPZ\_E0 Series 1008 (2520) inch (mm)

### Appearance/Dimensions

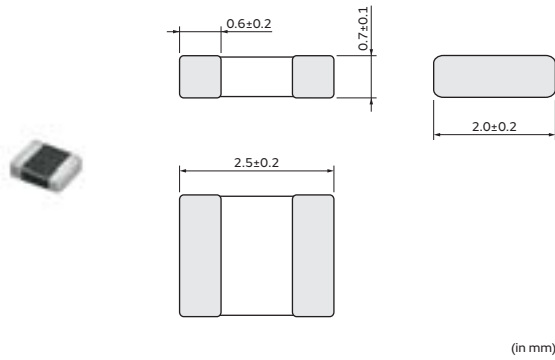

### Packaging

Code	Packaging	Minimum Quantity
L	ø180mm Embossed Taping	3000
B	Packing in Bulk	1000

### Rated Value (□: packaging code)

Part Number		Inductance	Inductance Test Frequency	Rated Current	DC Resistance	S.R.F* (min.)
Infotainment	Powertrain/Safety					
LQM2HPZR56ME0□	—	0.56μH ±20%	1MHz	1.5A(Ambient temp.85°C) 1.1A(Ambient temp.125°C)	0.06Ω±25%	70MHz

Operating temp.range: -55 to 125°C  
 Class of Magnetic Shield: Ferrite Core  
 \*S.R.F: Self Resonant Frequency

In operating temperatures exceeding +85°C, derating of current is necessary for this series. Please apply the derating curve shown in the chart according to the operating temperature. Please consider "Notice (Rating)." When rated current is applied to the products, the temperature rise caused by self-generated heat shall be limited to 40°C max.

### Inductance-Frequency Characteristics (Typ.)

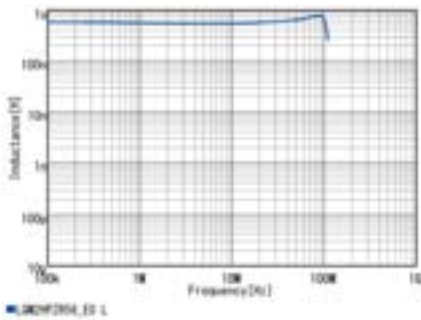

### Inductance-Current Characteristics (Typ.)

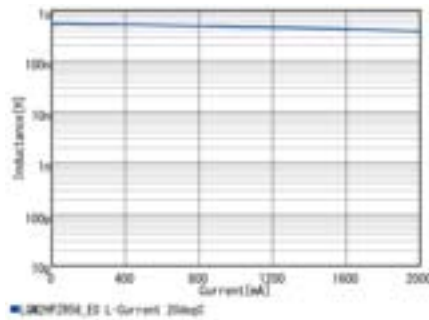

### Temperature Rise Characteristics (Typ.)

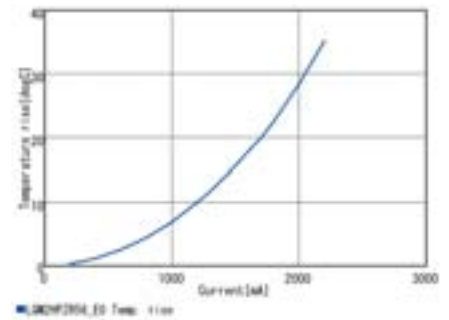

### Notice (Rating)

In operating temperatures exceeding +85°C, derating of current is necessary for this series. Please apply the derating curve shown in the chart according to the operating temperature.

#### Derating of Rated Current

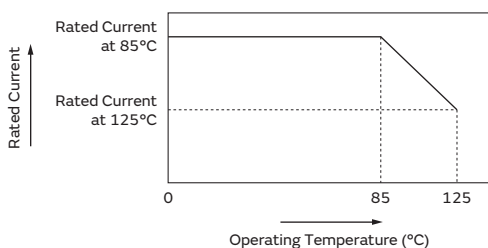

# Inductors for Power Lines

## LQM2HPZ\_G0 Series 1008 (2520) inch (mm)

### Appearance/Dimensions

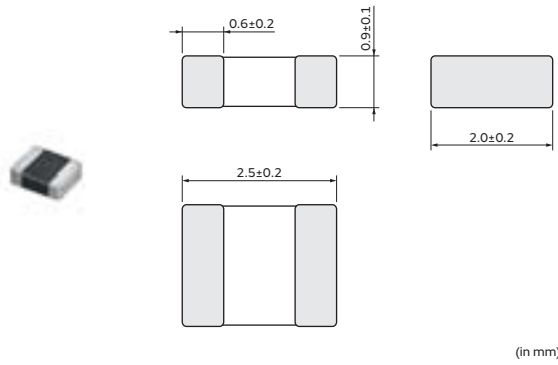

### Packaging

Code	Packaging	Minimum Quantity
L	ø180mm Embossed Taping	3000
B	Packing in Bulk	1000

### Rated Value (□: packaging code)

Part Number		Inductance	Inductance Test Frequency	Rated Current	DC Resistance	S.R.F* (min.)
Infotainment	Powertrain/Safety					
LQM2HPZR47MG0□	—	0.47μH ±20%	1MHz	1.8A(Ambient temp.85°C) 1.3A(Ambient temp.125°C)	0.040Ω(typ.)	100MHz
LQM2HPZ1R0MG0□	—	1.0μH ±20%	1MHz	1.6A(Ambient temp.85°C) 1.2A(Ambient temp.125°C)	0.055Ω(typ.)	60MHz
LQM2HPZ1R5MG0□	—	1.5μH ±20%	1MHz	1.5A(Ambient temp.85°C) 1.1A(Ambient temp.125°C)	0.070Ω(typ.)	50MHz
LQM2HPZ2R2MG0□	—	2.2μH ±20%	1MHz	1.3A(Ambient temp.85°C) 0.97A(Ambient temp.125°C)	0.080Ω(typ.)	40MHz
LQM2HPZ3R3MG0□	—	3.3μH ±20%	1MHz	1.2A(Ambient temp.85°C) 0.9A(Ambient temp.125°C)	0.10Ω(typ.)	30MHz
LQM2HPZ4R7MG0□	—	4.7μH ±20%	1MHz	1.1A(Ambient temp.85°C) 0.82A(Ambient temp.125°C)	0.11Ω(typ.)	25MHz

Operating temp.range: -55 to 125°C

Class of Magnetic Shield: Ferrite Core

\*S.R.F: Self Resonant Frequency

In operating temperatures exceeding +85°C, derating of current is necessary for the LQM2HP\_G0 series. Please apply the derating curve shown in the chart according to the operating temperature. Please consider "Notice (Rating)." When rated current is applied to the products, the temperature rise caused by self-generated heat shall be limited to 40°C max.

### Inductance-Frequency Characteristics (Typ.)

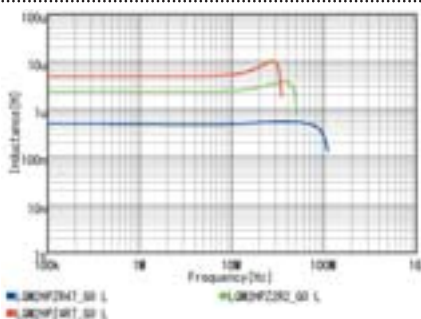

### Inductance-Current Characteristics (Typ.)

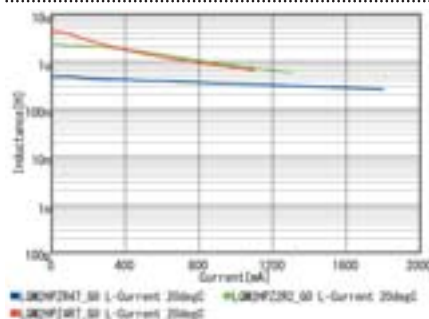

### Temperature Rise Characteristics (Typ.)

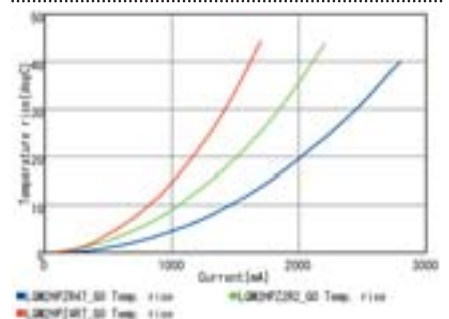

Continued on the following page. ↗

Continued from the preceding page. ↘

### Notice (Rating)

In operating temperatures exceeding +85°C, derating of current is necessary for this series.  
Please apply the derating curve shown in the chart according to the operating temperature.

#### Derating of Rated Current



# Inductors for Power Lines

## LQM2HPZ\_GC Series 1008 (2520) inch (mm)

### Appearance/Dimensions

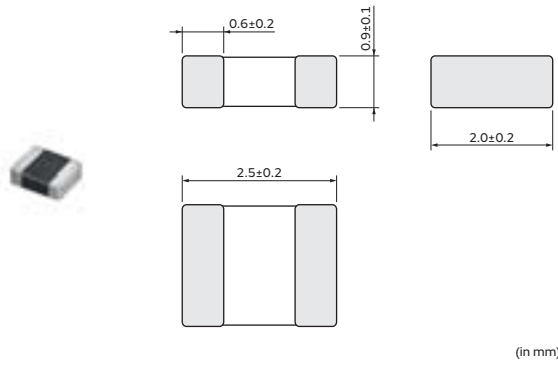

### Packaging

Code	Packaging	Minimum Quantity
L	ø180mm Embossed Taping	3000
B	Packing in Bulk	1000

### Rated Value (□: packaging code)

Part Number		Inductance	Inductance Test Frequency	Rated Current	DC Resistance	S.R.F* (min.)
Infotainment	Powertrain/Safety					
LQM2HPZ1R0MGC□	—	1.0μH ±20%	1MHz	1.5A(Ambient temp.85℃) 1.1A(Ambient temp.125℃)	0.08Ω±25%	50MHz
LQM2HPZ3R3MGC□	—	3.3μH ±20%	1MHz	1A(Ambient temp.85℃) 0.75A(Ambient temp.125℃)	0.16Ω±25%	30MHz
LQM2HPZ4R7MGC□	—	4.7μH ±20%	1MHz	0.8A(Ambient temp.85℃) 0.6A(Ambient temp.125℃)	0.18Ω±25%	25MHz

Operating temp.range: -55 to 125°C

Class of Magnetic Shield: Ferrite Core

\*S.R.F: Self Resonant Frequency

In operating temperatures exceeding +85°C, derating of current is necessary for this series. Please apply the derating curve shown in the chart according to the operating temperature. Please consider "Notice (Rating)." When rated current is applied to the products, the temperature rise caused by self-generated heat shall be limited to 40°C max.

### Inductance-Frequency Characteristics (Typ.)

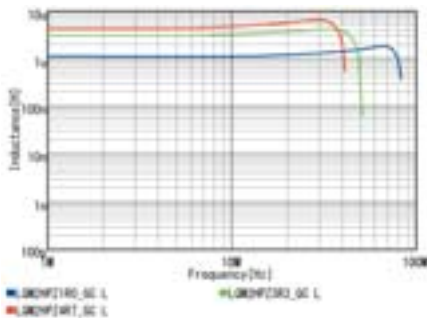

### Inductance-Current Characteristics (Typ.)

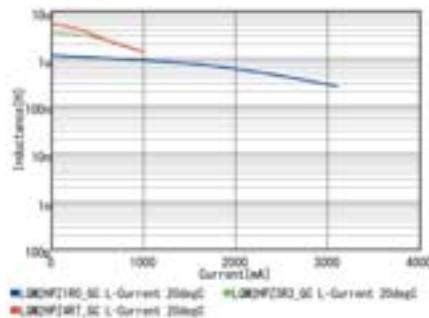

### Temperature Rise Characteristics (Typ.)

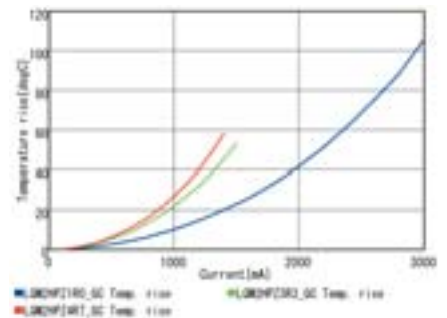

### Notice (Rating)

In operating temperatures exceeding +85°C, derating of current is necessary for this series.

Please apply the derating curve shown in the chart according to the operating temperature.

#### Derating of Rated Current

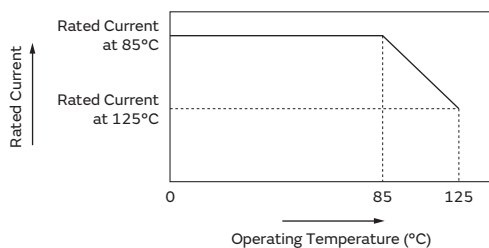

## Inductors for Power Lines

# LQM2HPZ\_GS Series 1008 (2520) inch (mm)

### Appearance/Dimensions

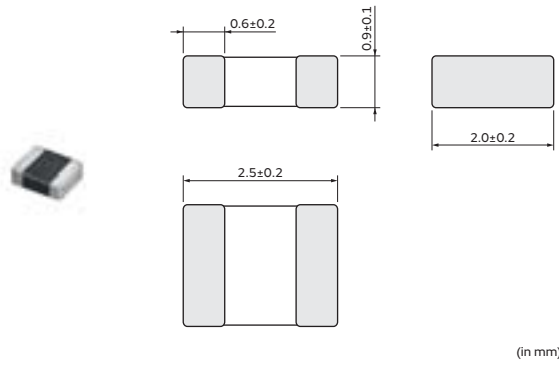

### Packaging

Code	Packaging	Minimum Quantity
L	ø180mm Embossed Taping	3000
B	Packing in Bulk	1000

### Rated Value (□: packaging code)

Part Number		Inductance	Inductance Test Frequency	Rated Current	DC Resistance	S.R.F* (min.)
Infotainment	Powertrain/Safety					
LQM2HPZ2R2MGS□	—	2.2μH ±20%	1MHz	1.1A(Ambient temp.85°C) 0.82A(Ambient temp.125°C)	0.18Ω±25%	40MHz
LQM2HPZ3R3MGS□	—	3.3μH ±20%	1MHz	1.05A(Ambient temp.85°C) 0.78A(Ambient temp.125°C)	0.21Ω±25%	20MHz
LQM2HPZ4R7MGS□	—	4.7μH ±20%	1MHz	1A(Ambient temp.85°C) 0.75A(Ambient temp.125°C)	0.25Ω±25%	20MHz

Operating temp.range: -55 to 125°C

Class of Magnetic Shield: Ferrite Core

\*S.R.F: Self Resonant Frequency

In operating temperatures exceeding +85°C, derating of current is necessary for this series. Please apply the derating curve shown in the chart according to the operating temperature. Please consider "Notice (Rating)." When rated current is applied to the products, the temperature rise caused by self-generated heat shall be limited to 40°C max.

### Inductance-Frequency Characteristics (Typ.)

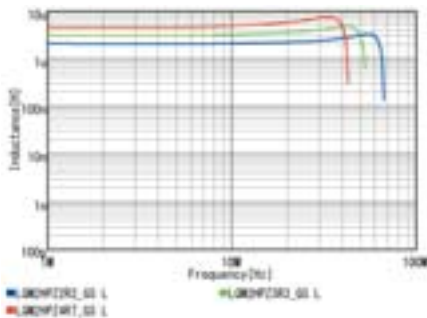

### Inductance-Current Characteristics (Typ.)

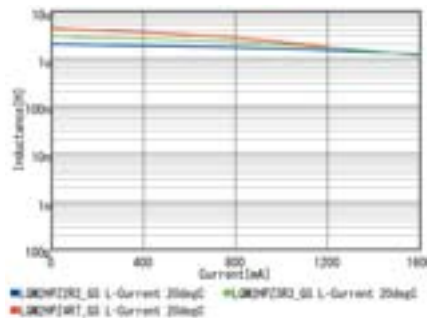

### Temperature Rise Characteristics (Typ.)

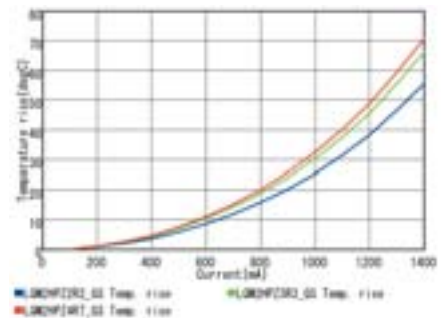

### Notice (Rating)

In operating temperatures exceeding +85°C, derating of current is necessary for this series.

Please apply the derating curve shown in the chart according to the operating temperature.

#### Derating of Rated Current

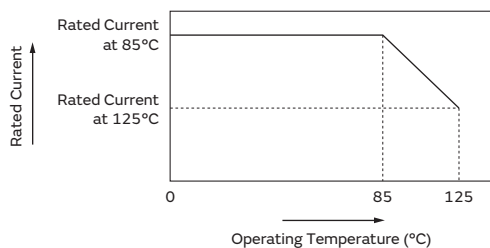



## Inductors for Power Lines

# LQM2HPZ\_J0 Series 1008 (2520) inch (mm)

### Appearance/Dimensions

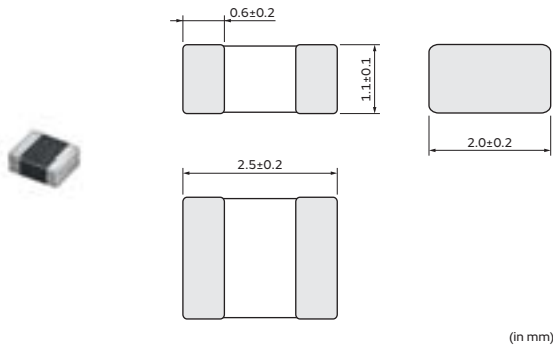

### Packaging

Code	Packaging	Minimum Quantity
L	ø180mm Embossed Taping	3000
B	Packing in Bulk	1000

### Rated Value (□: packaging code)

Part Number		Inductance	Inductance Test Frequency	Rated Current	DC Resistance	S.R.F* (min.)
Infotainment	Powertrain/Safety					
LQM2HPZ1R0MJ0□	—	1.0μH ±20%	1MHz	1.5A(Ambient temp.85°C) 1.1A(Ambient temp.125°C)	0.09Ω±25%	70MHz
LQM2HPZ2R2MJ0□	—	2.2μH ±20%	1MHz	1A(Ambient temp.85°C) 0.75A(Ambient temp.125°C)	0.12Ω±25%	40MHz
LQM2HPZ3R3MJ0□	—	3.3μH ±20%	1MHz	1A(Ambient temp.85°C) 0.75A(Ambient temp.125°C)	0.12Ω±25%	30MHz

Operating temp.range: -55 to 125°C

Class of Magnetic Shield: Ferrite Core

\*S.R.F: Self Resonant Frequency

In operating temperatures exceeding +85°C, derating of current is necessary for this series. Please apply the derating curve shown in the chart according to the operating temperature. Please consider "Notice (Rating)." When rated current is applied to the products, the temperature rise caused by self-generated heat shall be limited to 40°Cmax.

### Inductance-Frequency Characteristics (Typ.)

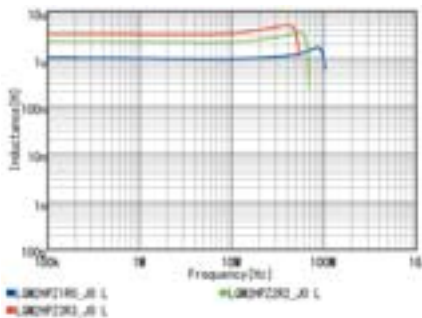

### Inductance-Current Characteristics (Typ.)

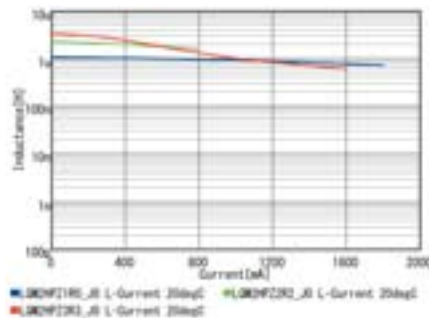

### Temperature Rise Characteristics (Typ.)

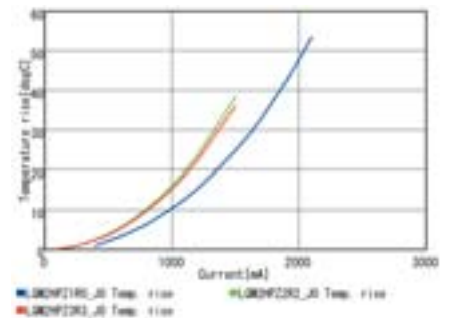

### Notice (Rating)

In operating temperatures exceeding +85°C, derating of current is necessary for this series.

Please apply the derating curve shown in the chart according to the operating temperature.

#### Derating of Rated Current

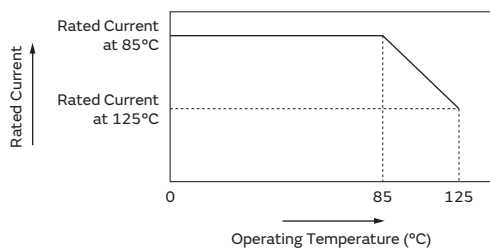

## Inductors for Power Lines (LQ Series) ⚠️Caution/Notice

### ⚠️Caution

#### Rating

##### 1. About the Rated Current

Do not use products beyond the rated current as this may create excessive heat and deteriorate the insulation resistance.

For the usage of powertrain and safety be sure to provide an appropriate fail-safe function on your product to prevent a second damage that may be caused by the abnormal function or the failure of our product.

##### 2. About Excessive Surge Current

Surge current (pulse current or rush current) greater than the specified rated current applied to the product may cause a critical failure, such as an open circuit, burnout caused by excessive temperature rise.

Please contact us in advance in case of applying the surge current.

### Notice

#### Storage and Operating Condition

##### <Operating Environment>

Do not use products in chemical atmosphere such as chlorine gas, acid or sulfide gas.

##### <Storage Requirements>

##### 1. Storage Period

LQM series should be used within 6 months; the other products should be used within 12 months.

Check solderability if this period is exceeded.

##### 2. Storage Conditions

(1) Store products in a warehouse in compliance with the following conditions:

Temperature: -10 to +40°C.

Humidity: 15 to 85% (relative humidity)

Do not subject products to rapid changes in temperature and humidity.

Do not store them in chemical atmosphere such as one containing sulfurous acid gas or alkaline gas.

This will prevent electrode oxidation, which causes poor solderability and possible corrosion of inductors.

(2) Do not store products in bulk packaging to prevent collision among inductors, which causes core chipping and wire breakage.

(3) Store products on pallets to protect from humidity, dust, etc.

(4) Avoid heat shock, vibration, direct sunlight, etc.

#### Handling

This item is designed to have sufficient strength, but handle with care to avoid chipping or breaking its ceramic structure.

##### LQH\_C/D/P series

- To prevent breaking the wire, avoid touching with sharp material, such as tweezers or the bristles of a cleaning brush, to the wire wound portion of this product.
- To prevent breaking the core, avoid applying excessive mechanical shock to products mounted on the board.
- Temperature may rise up to max. 40°C when applying the rated current to Inductors for Power Lines. Be careful of the temperature rating of the circuit board and components around the chip Inductors.

##### LQM series

- There is the possibility that magnetism may change the inductance value. Do not use a magnet or tweezers with magnetism when handling chip inductors. (The tip of the tweezers should be molded with resin or pottery.)
- When the excessive current over rated current is applied, it may cause the inductance value to change due to magnetism.

##### <Transportation>

Do not apply excessive vibration or mechanical shock to products.

##### <Resin Coating>

When coating products with resin, the relatively high resin curing stress may change inductance values. For exterior coating, select resin carefully so that electrical and mechanical performance of the product is not affected. Prior to use, please evaluate reliability with the product mounted in your application set.

Continued on the following page. ↗

## Inductors for Power Lines (LQ Series) ⚠Caution/Notice

Continued from the preceding page. ↘

### (LQH series)

An open circuit issue may occur by mechanical stress caused by the resin, amount/cured shape of resin, or operating conditions, etc. Some resins containing impurities or chloride may possibly generate chlorine by hydrolysis under some operating conditions, causing corrosion of the inductor wire and leading to an open circuit.

### <Rated Current>

#### (LQH2HP\_JR Series-LQH44P\_GR Series)

Inductance will be more than the value, which is 30% down from minimum rated Inductance value.

#### (Other LQH\_P Series)

Inductance will be within  $\pm 30\%$  of nominal Inductance value.

### ▪ Based on Temperature Rise

For LQH\_P series, rated current is set to keep temperature rise caused by self heating 40°C or less. For other Inductors for Power Lines, please refer to individual specifications.

### <Handling of a Substrate>

After mounting products on a substrate, do not apply any stress to the product caused by bending or twisting the substrate when cropping the substrate, inserting and removing a connector from the substrate, or tightening a screw to the substrate.

Excessive mechanical stress may cause cracking in the Product.



## Inductors for Power Lines (except for LQ Series) ⚠️Caution/Notice

### ⚠️Caution

#### Rating

##### 1. About the Rated Current

Do not use products beyond the rated current as this may create excessive heat and deteriorate the insulation resistance.

Be sure to provide an appropriate fail-safe function on your product to prevent a second damage that may be caused by the abnormal function or the failure of our product.

##### 2. About Excessive Surge Current

Surge current (pulse current or rush current) greater than the specified rated current applied to the product may cause a critical failure, such as an open circuit, burnout caused by excessive temperature rise. Please contact us in advance in case of applying the surge current.

### Notice

#### Precaution for Application

(1) The part must be pre-heated before soldering if reflow is applied.

The difference between pre-heat temperature and soldering temperature must be within 150°C.

(2) If a soldering iron is applied, the soldering process must be completed within 3 seconds at a soldering temperature lower than 350°C.

The tip of the soldering iron must not touch the terminal electrode in this process.

(3) Terminals should not be handled with fingers. This is to prevent deterioration in solderability.

(4) Soldering using a soldering iron must be done only once for each part.

(5) PPCB mount: this part must be handled with care to minimize any physical stress to the part at the board assembly process.

(6) To minimize the influence to the part, the thickness of PCB, land dimension, and the amount of solder must be evaluated carefully by individual application.

(7) If a washing process is applied, please make sure there is no problem with operating.

(8) Products should not be dropped on the floor. This is to prevent damage to the products.

(9) Although electrical performance is satisfactory, audible noises may be made if audio frequency ingredient is contained in current.

Before using, please make sure there aren't any problem with operating.

#### Handling

##### ○Storage and Handling Requirements

###### (1) Storage period

Use the products within 6 months after delivered.

Solderability should be checked if this period is exceeded.

###### (2) Storage conditions

• Products should be stored in the warehouse on the following conditions.

Temperature: -10 to 40°C

Humidity: 15 to 85% relative humidity No rapid change on temperature and humidity

Don't keep products in corrosive gases such as sulfur, chlorine gas or acid, or it may cause oxidization of electrode, resulting in poor solderability.

• Products should not be stored on bulk packaging condition to prevent the chipping of the core and the breaking of winding wire caused by the collision between the products.

• Products should be stored on the palette for the prevention of the influence from humidity, dust and so on.

• Products should be stored in the warehouse without heat shock, vibration, direct sunlight and so on.

###### (3) Handling Condition

Care should be taken when transporting or handling product to avoid excessive vibration or mechanical shock.

##### ○Resin coating

The inductance value may change and/or it may affect on the product's performance due to high cure-stress of resin to be used for coating / molding products. So please pay your careful attention when you select resin. In prior to use, please make the reliability evaluation with the product mounted in your application set.

Continued on the following page. ↗

## Inductors for Power Lines (except for LQ Series) ⚠Caution/Notice

Continued from the preceding page. ↘

### ○Metal alloy inductor product\*

Metal alloy inductor product\* employs a core with low insulation resistance, pay strict attention when use it

- a) Do not make any through holes and copper pattern under the coil. except a copper pattern to the electrode.
- b) Design/mount any components not to contact this product.

Metal alloy inductor product\*...

DFE201612P\_D, DFE252012P\_D, DFEG7030D,  
DFEH7030D, DFEG10040D, DFEH10040D,  
DFEG12060D, DFEH12060D

### ○Temperature Rise

Temperature rise of power choke coil depends on the installation condition in end products.

It shall be confirmed in the actual end product that temperature rise of power choke coil is in the limit specified temperature class

## Inductors for Power Lines Soldering and Mounting

### 1. Standard Land Pattern Dimensions

A high Q value is achieved when the PCB electrode land pattern is designed so that it does not project beyond the chip Inductors (chip coils) electrode.

■ Land Pattern + Solder Resist    □ Land Pattern    □ Solder Resist  
 (in mm)

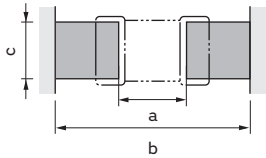
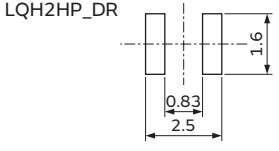
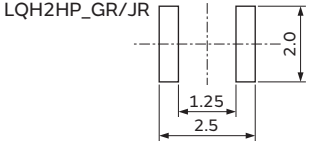
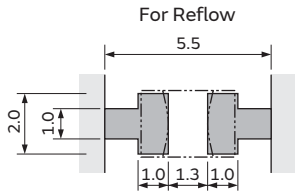
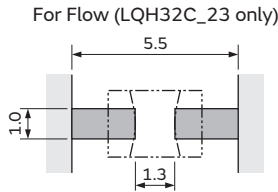
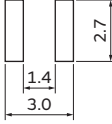
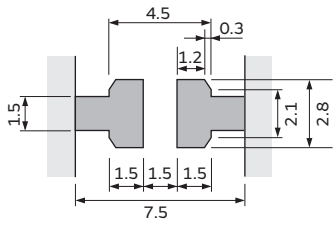
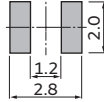
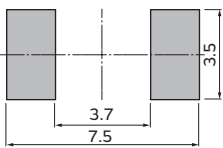
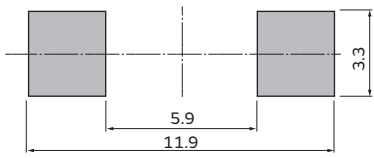

Series	Standard Land Dimensions				
	Part Number	a	b	c	
LQM18P LQM21P LQM2MP LQM2HP LQH2MP LQH31H LQH32P LQH44P_GR LQH5BP		LQM18P	0.7	1.8-2.0	0.7
		LQM21P	1.2	3.0-4.0	1.0
		LQM2MP	0.8	2.4	1.8
		LQM2HP	1.6	3.0	1.5
		LQH2MP	0.8	2.6	1.0
		LQH31H	1.0	4.5	1.5
		LQH32P	1.3	3.8	2.0
		LQH44P_GR	1.5	4.4	2.7
		LQH5BP	1.8	5.5	4.1
	LQH2HP		LQH2HP_GR/JR		
LQH32C LQH32D	 <p>For Reflow</p>	 <p>For Flow (LQH32C_23 only)</p>			
	*Applicable to flow soldering (LQH32C_23 only)				
LQH3NP					
LQH43P					
DFE252012P_D					
DFEG7030D DFEH7030D					
DFEG10040D DFEH10040D					

Attention should be paid to potential magnetic coupling effects when using the Inductors (coils) as a resonator.

Continued on the following page. ↗

## Inductors for Power Lines Soldering and Mounting

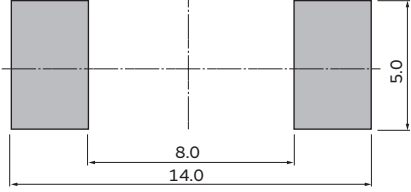
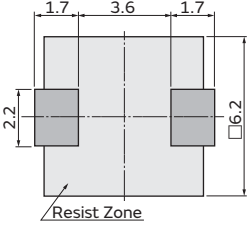
Continued from the preceding page. ↘

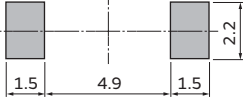
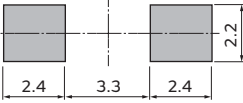
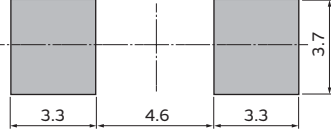
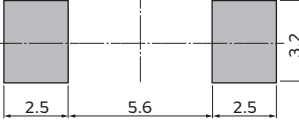
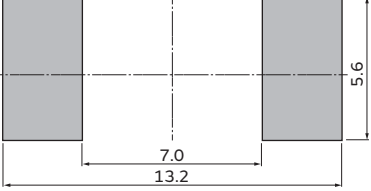
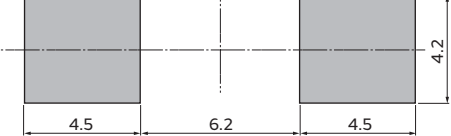
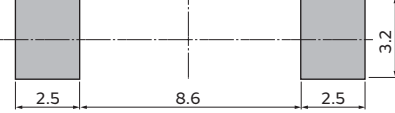
Series	Standard Land Dimensions
<b>DFEG12060D</b> <b>DFEH12060D</b>	
<b>MBH6045C</b>	
<b>MDH6045C</b>	
<b>MBH7045C</b>	
<b>MDH7045C</b>	
<b>MDH10060C</b>	
<b>MBH10145C</b>	
<b>MBH12282C</b>	
<b>MDH12577C</b>	
<b>MBH12575C</b>	

Attention should be paid to potential magnetic coupling effects when using the Inductors (coils) as a resonator.

Continued on the following page. ↗

## Inductors for Power Lines Soldering and Mounting

Continued from the preceding page. ↘

### 2. Standard Soldering Conditions

#### (1) Soldering method

Chip Inductors (Chip coils) can be flow or reflow soldered.

Please contact Murata regarding other soldering methods.

As for LQM18P/ LQH2HP/2MP/32D/3NP/32P/43P/ 44P/5BP series, please use reflow soldering.

Solder: Use Sn-3.0Ag-0.5Cu solder.

Flux: Use rosin-based flux, but not strongly acidic flux (with chlorine content exceeding 0.2wt%).

Do not use water-soluble flux.

For additional mounting methods, please contact Murata.

#### (2) Soldering profile

##### ● Flow Soldering profile (Sn-3.0Ag-0.5Cu solder)

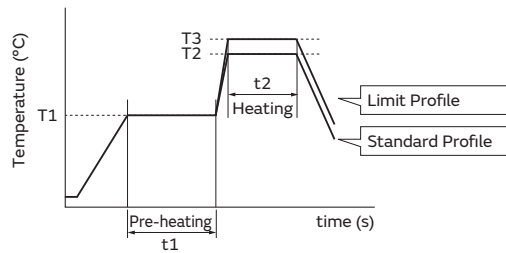

Series	Pre-heating		Standard Profile			Limit Profile		
	Temp. (T1)	Time. (t1)	Temp. (T2)	Time. (t2)	Cycle of flow	Temp. (T3)	Time. (t2)	Cycle of flow
LQM21P/2MP/2HP	150°C	60s min.	250°C	4 to 6s	2 times max.	265±3°C	5s max.	2 times max.
LQH32C	150°C	60s min.	250°C	4 to 6s	2 times max.	265±3°C	5s max.	1 time

##### ● Reflow Soldering profile (LQ Series) (Sn-3.0Ag-0.5Cu solder)

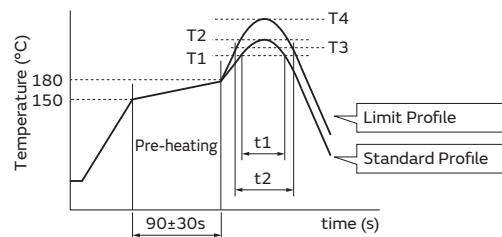

Series	Standard Profile				Limit Profile			
	Temp. (T1)	Time. (t1)	Peak temperature (T2)	Cycle of reflow	Temp. (T3)	Time. (t2)	Peak temperature (T4)	Cycle of reflow
LQM18P/21P/2MP/2HP LQH2HP/2MP LQH32D LQH3NP/32P/43P/44P/5BP	220°C	30 to 60s	245±3°C	2 times max.	230°C	60s max.	260°C/10s	2 times max.
LQH32C	220°C	30 to 60s	245±3°C	2 times max.	230°C	60s max.	260°C/10s	1 time

Continued on the following page. ↗



## Inductors for Power Lines Soldering and Mounting

Continued from the preceding page. ↘

### ●Reflow Soldering profile (except for LQ Series) (Sn-3.0Ag-0.5Cu solder)

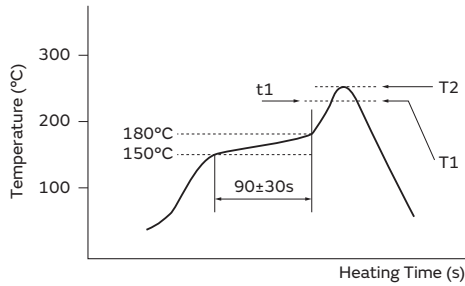

\*Reflow Times: 2 times max.  
 \*We recommend an infrared ray as the heat source of the reflow bath.  
 However halogen lamp should not be used; the side heat would be beyond the range of resistance heat, so we do not recommend it.

Series	Heating		Peak Temperature (T2)	Cycle of Flow
	Temp. (T1)	Time (t1)		
DFE252012P_D MBH6045C MDH6045C MBH7045C MDH7045C MDH10060C MBH10145C MBH12282C MDH12577C MBH12575C	230°C	20 to 40s	250+5/-0°C	2 times max.
DFEG7030D DFEH7030D DFEG10040D DFEH10040D DFEG12060D DFEH12060D	230°C	20 to 40s	255+5/-0°C	2 times max.

### (3) Reworking with Soldering Iron

Preheating at 150°C for 1 minute is required. Do not directly touch the products with the tip of the soldering iron in order to prevent the crack on the products due to the thermal shock.

Soldering iron power output: 80W max.

Temperature of soldering iron tip  
 : 350°C (except for LQH5BP)  
 : 380°C (LQH5BP only)

Diameter of soldering iron end: 3.0mm max.

Soldering time: within 3 s

Please keep the fix time with the soldering iron within 2 times.

(except for LQH2HP\_GR, LQH2MP)

Please keep the fix time with the soldering iron within only once. (LQH2HP\_GR, LQH2MP only)

## 3. Mounting Instructions

### (1) Land Pattern Dimensions

Large lands reduce Q of the mounted chip. Also, large protruding land areas (bordered by lines having dimensions 'c' and 'd' shown) cause floating and electrode leaching.

### (2) Land Pattern Designing (LQH series)

Please follow the recommended patterns. Otherwise, their performance, which includes electrical performance or solderability, may be affected, or result in "position shift" in the soldering process.

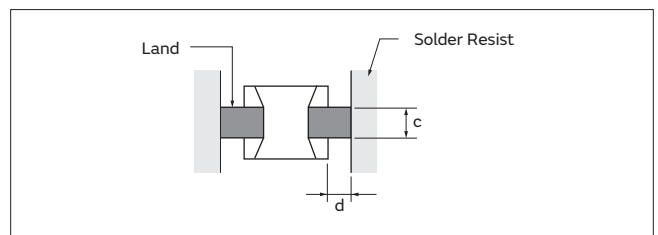

Continued on the following page. ↗

## Inductors for Power Lines Soldering and Mounting

Continued from the preceding page. ↘

### (3) Magnetic Coupling

Since some chip inductors (chip coils) are constructed like an open magnetic circuit, narrow spacing between inductors (coils) may cause magnetic coupling. LQM and LQH\_P series have a magnetically shielded structure. The structure makes their coupling coefficient smaller than that of conventional chip inductors (chip coils).

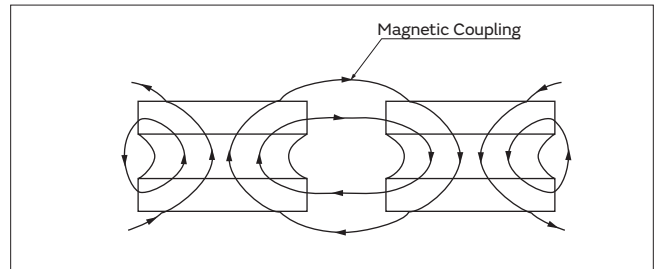

### (4) PCB Warping

PCB should be designed so that products are not subjected to the mechanical stress caused by warping the board.

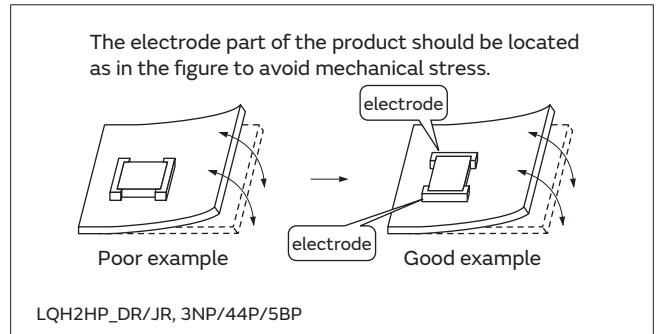
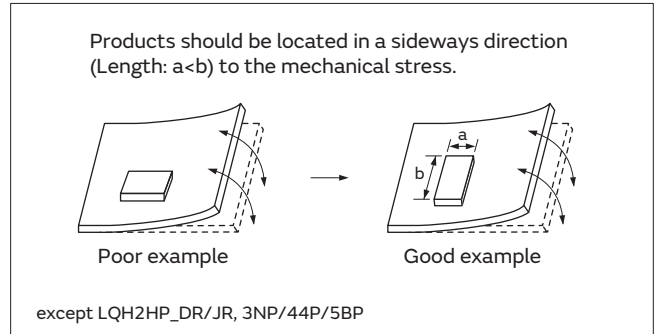

### (5) Amount of Solder Paste

Excessive solder causes electrode corrosion, while insufficient solder causes low electrode bonding strength. Adjust the amount of solder paste as shown on the right so that solder is applied.

Guideline of solder paste thickness

- LQM, LQH2HP/2MP/3NP/32P/43P/44P/5BP: 100 to 150 $\mu$ m
- LQH31H/32C/32D, LQH43N: 200 to 300 $\mu$ m

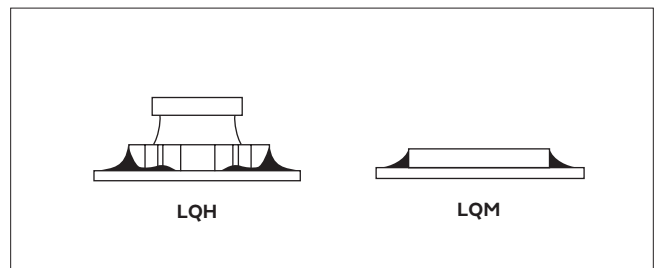

### (6) Amount of Adhesive

If too much adhesive is applied, then it may overflow into the land or termination areas and yield poor solderability. In contrast, if insufficient adhesive is applied, or if the adhesive is not sufficiently hardened, then the chip may become detached during flow soldering. Apply the adhesive in accordance with the conditions shown in the chart.

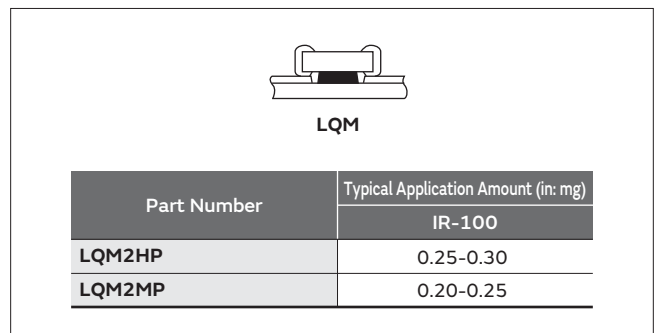

Continued on the following page. ↗

## Inductors for Power Lines Soldering and Mounting

Continued from the preceding page. ↘

### 4. Cleaning

The following conditions should be observed when cleaning chip inductors (chip coils):

(1) Cleaning Temperature: 60°C max. (40°C max. for alcohol cleaning agents)

(2) Ultrasonic

Output: 20W/l max.

Duration: 5 minutes max.

Frequency: 28 to 40kHz

Care should be taken not to cause resonance of the PCB and mounted products.

(3) Cleaning agent

The following cleaning agents have been tested on individual components. Evaluation in complete assembly should be done prior to production.

(a) Alcohol cleaning agents

Isopropyl alcohol (IPA)

(b) Aqueous cleaning agents

Pine Alpha ST-100S

(4) Ensure that flux residue is completely removed.

Component should be thoroughly dried after aqueous agents have been removed with deionized water.

For additional cleaning methods, please contact Murata.

## Inductors for Power Lines Packaging

### Minimum Quantity and 8mm Width Taping Dimensions (1)

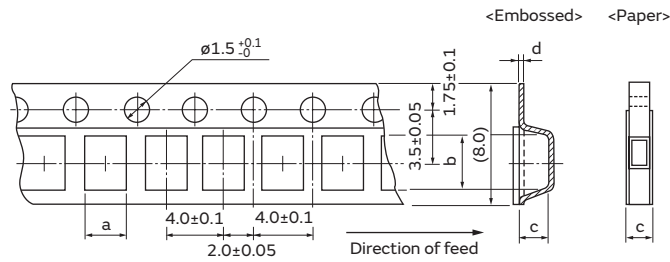

Dimension of the cavity of embossed tape is measured at the bottom side.

#### Paper Tape

Part Number	Dimensions		Total Thickness of Tape c	Packaging Code (Minimum Qty. [pcs.])		
	a	b		ø180mm reel	ø330mm reel	Bulk
LQM18P_CH	1.1	1.9	0.95 max.	D (4000)	-	B (1000)
LQM18P_DH	1.05	1.85	1.05 max.	D (4000)	-	B (1000)
LQM18P_FH	1.05	1.85	1.15 max.	D (4000)	-	B (1000)
LQM21P_C0	1.45	2.25	0.8 max.	D (4000)	-	B (1000)
LQM21P_G	1.45	2.25	1.1 max.	D (4000)	-	B (1000)

#### Embossed Tape

Part Number	Dimensions (c: Depth of Cavity)				Packaging Code (Minimum Qty. [pcs.])		
	a	b	c	d	ø180mm reel	ø330mm reel	Bulk
LQH2HP_DR	2.3	2.8	0.7	0.25	L (4000)	-	-
LQH2HP_GR	2.3	2.8	1.1	0.25	L (3000)	-	-
LQH2HP_JR	2.3	2.8	1.3	0.25	L (2000)	-	-
LQH2MP_GR	1.9	2.3	1.05	0.25	L (3000)	-	-
LQH32C_33/23	2.9	3.6	2.1	0.2	L (2000)	K (7500)	B (500)
LQH32C_53	2.9	3.6	1.7	0.2	L (2000)	K (7500)	B (500)
LQH32D_23	2.9	3.6	2.1	0.2	L (2000)	K (7500)	-
LQH32D_53	2.9	3.6	1.7	0.2	L (2000)	K (7500)	-
LQH32P	2.9	3.6	1.7	0.2	L (2000)	K (7500)	-
LQM2HP_E0	2.3	2.8	0.9	0.25	L (3000)	-	B (1000)
LQM2HP_G	2.3	2.8	1.1	0.25	L (3000)	-	B (1000)
LQM2HP_J0	2.25	2.75	1.3	0.25	L (3000)	-	B (1000)
LQM2MP_G0	1.85	2.25	1.1	0.25	L (3000)	-	B (1000)
LQM2MP_JH	1.9	2.4	1.3	0.25	L (3000)	-	B (1000)

(in mm)

Continued on the following page. ↗

## Inductors for Power Lines Packaging

Continued from the preceding page. ↘

### Minimum Quantity and 8mm Width Taping Dimensions (2)

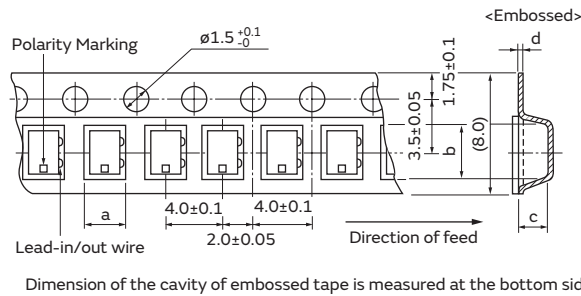

Embossed Tape

Part Number	Dimensions (c: Depth of Cavity)				Packaging Code (Minimum Qty. [pcs.])		
	a	b	c	d	ø180mm reel	ø330mm reel	Bulk
LQH3NP_GR	3.3	3.3	1.1	0.3	L (3000)	-	-
LQH3NP_JR/ME	3.3	3.3	1.6	0.2	L (2000)	-	-

(in mm)

### Minimum Quantity and 12mm Width Embossed Taping Dimensions

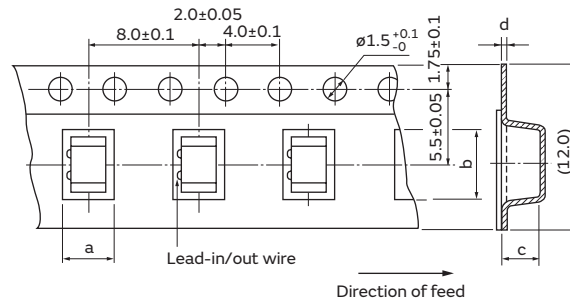

Embossed Tape

Part Number	Dimensions (c: Depth of Cavity)				Packaging Code (Minimum Qty. [pcs.])		
	a	b	c	d	ø180mm reel	ø330mm reel	Bulk
LQH43P	3.6	4.9	2.7	0.3	L (500)	K (2500)	-
LQH44P_GR	4.3	4.3	1.4	0.3	L (1000)	K (4500)	-
LQH5BP	5.3	5.3	2.4	0.3	L (500)	K (3000)	-

(in mm)

Continued on the following page. ↗

## Inductors for Power Lines Packaging

Continued from the preceding page. ↘

### Tape and Reel Dimensions

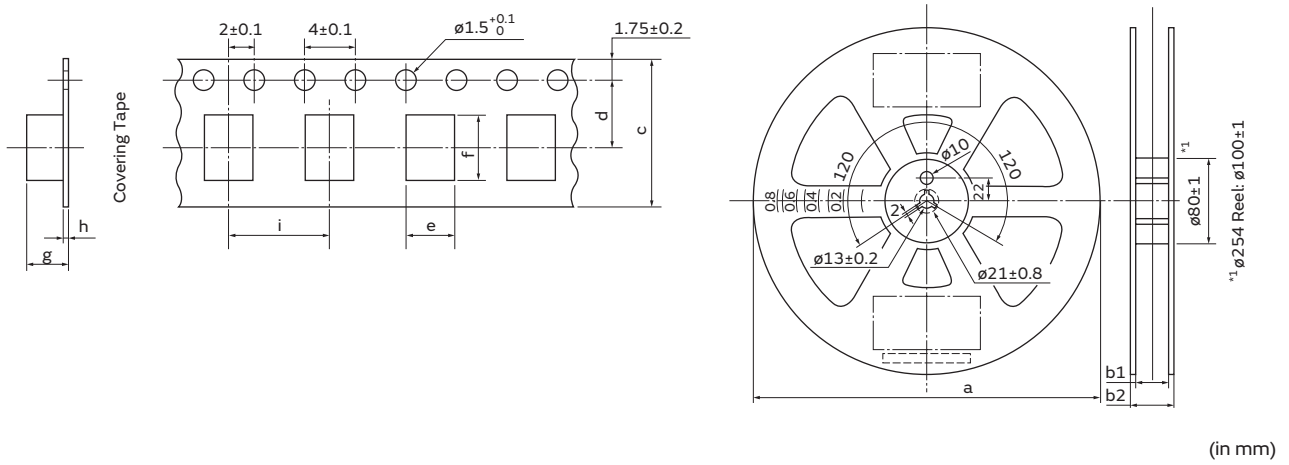

#### Surface Mounting Type, Reel/Tape List

Series	Reel Size (mm)			Tape Size (mm)							Q'ty 1 Reel
	a	b1	b2	c	d	e	f	g	h	i	
DFE252012P_D	ø180	9.0±0.3	11.4±1	8.0±0.2	3.5±0.05	2.20±0.1	2.75±0.1	1.3±0.1	0.25±0.05	4.0±0.1	3000
DFEG7030D	ø330	17.5±0.5	21.5±1	16.0±0.3	7.5±0.1	7.1±0.1	7.8±0.1	3.3±0.1	0.4±0.05	12.0±0.1	1000
DFEH7030D	ø330	17.5±0.5	21.5±1	16.0±0.3	7.5±0.1	7.1±0.1	7.8±0.1	3.3±0.1	0.4±0.05	12.0±0.1	1000
DFEG10040D	ø330	25.5±0.5	29.5±1	24.0±0.3	11.5±0.1	10.5±0.1	12.1±0.1	4.3±0.1	0.4±0.05	16.0±0.1	500
DFEH10040D	ø330	25.5±0.5	29.5±1	24.0±0.3	11.5±0.1	10.5±0.1	12.1±0.1	4.3±0.1	0.4±0.05	16.0±0.1	500
DFEG12060D	ø330	25.5±0.5	29.5±1	24.0±0.3	11.5±0.1	13.2±0.1	13.3±0.1	6.4±0.1	0.4±0.05	16.0±0.1	500
DFEH12060D	ø330	25.5±0.5	29.5±1	24.0±0.3	11.5±0.1	13.2±0.1	13.3±0.1	6.4±0.1	0.4±0.05	16.0±0.1	500
MBH6045C	ø330	17.5±0.5	21.5±1	16.0±0.3	7.5±0.1	6.3±0.1	6.3±0.1	5.1±0.1	0.4±0.1	12.0±0.1	1000
MDH6045C	ø330	17.5±0.5	21.5±1	16.0±0.3	7.5±0.1	6.3±0.1	6.3±0.1	5.1±0.1	0.4±0.1	12.0±0.1	1000
MBH7045C	ø330	17.5±0.5	21.5±1	16.0±0.3	7.5±0.1	7.3±0.1	7.3±0.1	4.9±0.1	0.4±0.05	12.0±0.1	1000
MDH7045C	ø330	17.5±0.5	21.5±1	16.0±0.3	7.5±0.1	7.7±0.1	7.4±0.1	5.3±0.1	0.4±0.1	12.0±0.1	1000
MDH10060C	ø330	25.5±0.5	29.5±1	24.0±0.1	11.5±0.1	10.5±0.1	10.4±0.1	6.4±0.1	0.5±0.1	16.0±0.1	500
MBH10145C	ø330	25.5±0.5	29.5±1	24.0±0.3	11.5±0.1	10.5±0.1	10.5±0.1	4.9±0.1	0.4±0.1	16.0±0.1	500
MBH12282C	ø330	25.5±0.5	29.5±1	24.0±0.3	11.5±0.1	12.6±0.1	12.6±0.1	8.6±0.1	0.5±0.1	16.0±0.1	300
MDH12577C	ø330	25.5±0.5	29.5±1	24.0±0.1	11.5±0.1	13.2±0.1	12.9±0.1	8.2±0.1	0.5±0.05	16.0±0.1	300
MBH12575C	ø330	25.5±0.5	29.5±1	24.0±0.3	11.5±0.1	12.9±0.1	12.9±0.1	8.0±0.1	0.5±0.1	16.0±0.1	300

● Part Numbering

Inductors for General Circuits for Automotive

(Part Number) 

LQ	H	43	N	Z	4R7	M	0	3	L
①	②	③	④	⑤	⑥	⑦	⑧	⑨	⑩

① Product ID

Product ID	
LQ	Chip Inductors (Chip Coils)

② Structure

Code	Structure
H	Wire Wound Type (Ferrite Core)

③ Dimensions (LxW)

Code	Nominal Dimensions (LxW)	Size Code (in inch)
32	3.2x2.5mm	1210
43	4.5x3.2mm	1812

④ Applications and Characteristics

Code	Applications and Characteristics
N	for Resonant Circuit

⑤ Category

Code	Category	
H	Automotive	Powertrain/Safety
Z	Automotive	Infotainment

⑥ Inductance

Expressed by three-digit alphanumerics. The unit is micro-henry ( $\mu\text{H}$ ). The first and second figures are significant digits, and the third figure expresses the number of zeros that follow the two figures. If there is a decimal point, it is expressed by the capital letter "R". In this case, all figures are significant digits. If inductance is less than  $0.1\mu\text{H}$ , the inductance code is expressed by a combination of two figures and the capital letter "N", and the unit of inductance is nano-henry (nH). The capital letter "N" indicates the unit of "nH", and also expresses a decimal point. In this case, all figures are significant digits. For those products whose inductance values are specified using three designated digits, these values may be indicated using the closest two digits instead.

⑦ Inductance Tolerance

Code	Inductance Tolerance
J	$\pm 5\%$
K	$\pm 10\%$
M	$\pm 20\%$

⑧ Features

Code	Features
0/2	Standard Type

⑨ Electrode

•Lead (Pb) Free

Code	Electrode
3	LF Solder

⑩ Packaging

Code	Packaging
K	Embossed Taping ( $\phi 330\text{mm}$ Reel)
L	Embossed Taping ( $\phi 180\text{mm}$ Reel)

## Inductors for General Circuits

# LQH32NZ\_23/LQH32NH\_23 Series 1210 (3225) inch (mm)

### Appearance/Dimensions

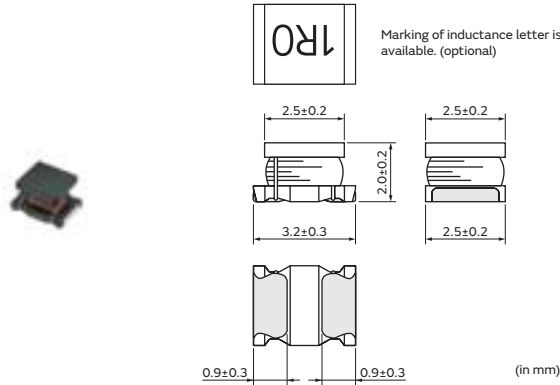

### Packaging

Code	Packaging	Minimum Quantity
K	ø330mm Embossed Taping	7500
L	ø180mm Embossed Taping	2000

### Rated Value (□: packaging code)

Part Number		Inductance	Q (min.)	Rated Current	Max. of DC Resistance*	DC Resistance*	S.R.F* (min.)
Infotainment	Powertrain/Safety						
LQH32NZ1R0K23□	—	1.0μH ±10%	20	445mA	0.5Ω	—	100MHz
—	LQH32NH1R0M23□	1.0μH ±20%	25	780mA	—	0.06Ω±20%	100MHz
—	LQH32NH1R2J23□	1.2μH ±5%	25	720mA	—	0.07Ω±20%	90MHz
LQH32NZ1R2K23□	—	1.2μH ±10%	20	425mA	0.6Ω	—	100MHz
—	LQH32NH1R5J23□	1.5μH ±5%	25	675mA	—	0.08Ω±20%	85MHz
LQH32NZ1R5K23□	—	1.5μH ±10%	20	400mA	0.6Ω	—	75MHz
—	LQH32NH1R8J23□	1.8μH ±5%	25	635mA	—	0.09Ω±20%	80MHz
LQH32NZ1R8K23□	—	1.8μH ±10%	20	390mA	0.7Ω	—	60MHz
—	LQH32NH2R2J23□	2.2μH ±5%	25	610mA	—	0.097Ω±20%	75MHz
LQH32NZ2R2K23□	—	2.2μH ±10%	20	370mA	0.8Ω	—	50MHz
—	LQH32NH2R7J23□	2.7μH ±5%	25	495mA	—	0.15Ω±20%	70MHz
LQH32NZ2R7K23□	—	2.7μH ±10%	20	320mA	0.9Ω	—	43MHz
—	LQH32NH3R3J23□	3.3μH ±5%	25	425mA	—	0.20Ω±20%	65MHz
LQH32NZ3R3K23□	—	3.3μH ±10%	20	300mA	1.0Ω	—	38MHz
—	LQH32NH3R9J23□	3.9μH ±5%	25	510mA	—	0.14Ω±20%	60MHz
LQH32NZ3R9K23□	—	3.9μH ±10%	20	290mA	1.1Ω	—	35MHz
—	LQH32NH4R7J23□	4.7μH ±5%	25	420mA	—	0.21Ω±20%	55MHz
LQH32NZ4R7K23□	—	4.7μH ±10%	20	270mA	1.2Ω	—	31MHz
—	LQH32NH5R6J23□	5.6μH ±5%	25	335mA	—	0.32Ω±20%	50MHz
LQH32NZ5R6K23□	—	5.6μH ±10%	20	250mA	1.3Ω	—	28MHz
—	LQH32NH6R8J23□	6.8μH ±5%	25	315mA	—	0.36Ω±20%	45MHz
LQH32NZ6R8K23□	—	6.8μH ±10%	20	240mA	1.5Ω	—	25MHz
—	LQH32NH8R2J23□	8.2μH ±5%	25	300mA	—	0.40Ω±20%	40MHz
LQH32NZ8R2K23□	—	8.2μH ±10%	20	225mA	1.6Ω	—	23MHz
LQH32NZ100J23□	LQH32NH100J23□	10μH ±5%	35	190mA/325mA	1.8Ω	0.34Ω±20%	20MHz/35MHz
LQH32NZ120J23□	LQH32NH120J23□	12μH ±5%	35	180mA/270mA	2.0Ω	0.50Ω±20%	18MHz/30MHz
LQH32NZ150J23□	LQH32NH150J23□	15μH ±5%	35	170mA/270mA	2.2Ω	0.50Ω±20%	16MHz/25MHz

Operating temp.range (LQH32NZ\_23 series): -40 to 105°C

Operating temp.range (LQH32NH\_23 series): -40 to 125°C

Inductance Test Frequency: 1MHz (1.0μH to 390μH), 1kHz (470μH to 560μH)

Q Test Frequency: 1MHz (1.0μH to 82μH), 796kHz (100μH to 560μH)

\*Max. of DC Resistance: LQH32NZ\_23 series

\*DC Resistance: LQH32NH\_23 series

Class of Magnetic Shield: No Shield

Only for reflow soldering

\*S.R.F: Self Resonant Frequency

When rated current is applied to the products, self-temperature rise shall be limited to 20°C max and inductance will be within ±10% of initial inductance value.

Continued on the following page. ↗



Continued from the preceding page. ↘

Part Number		Inductance	Q (min.)	Rated Current	Max. of DC Resistance*	DC Resistance*	S.R.F* (min.)
Infotainment	Powertrain/Safety						
LQH32NZ180J23□	LQH32NH180J23□	18μH ±5%	35	165mA/235mA	2.5Ω	0.64Ω±20%	15MHz/25MHz
LQH32NZ220J23□	LQH32NH220J23□	22μH ±5%	35	150mA/220mA	2.8Ω	0.74Ω±20%	14MHz/20MHz
LQH32NZ270J23□	LQH32NH270J23□	27μH ±5%	35	125mA/190mA	3.1Ω	1.00Ω±20%	13MHz/20MHz
LQH32NZ330J23□	LQH32NH330J23□	33μH ±5%	40	115mA/175mA	3.5Ω	1.14Ω±20%	12MHz/20MHz
LQH32NZ390J23□	LQH32NH390J23□	39μH ±5%	40	110mA/170mA	3.9Ω	1.27Ω±20%	11MHz/16MHz
LQH32NZ470J23□	LQH32NH470J23□	47μH ±5%	40	100mA/155mA	4.3Ω	1.46Ω±20%	11MHz/15MHz
LQH32NZ560J23□	LQH32NH560J23□	56μH ±5%	40	85mA/130mA	4.9Ω	2.00Ω±20%	10MHz/13MHz
LQH32NZ680J23□	LQH32NH680J23□	68μH ±5%	40	80mA/125mA	5.5Ω	2.25Ω±20%	9.0MHz/12MHz
LQH32NZ820J23□	LQH32NH820J23□	82μH ±5%	40	70mA/100mA	6.2Ω	3.25Ω±20%	8.5MHz/11MHz
LQH32NZ101J23□	LQH32NH101J23□	100μH ±5%	40	80mA/95mA	7.0Ω	3.65Ω±20%	8.0MHz/10MHz
LQH32NZ121J23□	LQH32NH121J23□	120μH ±5%	40	75mA/85mA	8.0Ω	4.20Ω±20%	7.5MHz/10MHz
LQH32NZ151J23□	LQH32NH151J23□	150μH ±5%	40	70mA/80mA	9.3Ω	4.85Ω±20%	7.0MHz/8.0MHz
LQH32NZ181J23□	LQH32NH181J23□	180μH ±5%	40	65mA/60mA	10.2Ω	7.60Ω±20%	6.0MHz
LQH32NZ221J23□	LQH32NH221J23□	220μH ±5%	40	65mA/60mA	11.8Ω	8.45Ω±20%	5.5MHz
LQH32NZ271J23□	LQH32NH271J23□	270μH ±5%	40/50	65mA/55mA	12.5Ω	9.70Ω±20%	5.0MHz
LQH32NZ331J23□	LQH32NH331J23□	330μH ±5%	40/50	65mA/50mA	13.0Ω	11.0Ω±20%	5.0MHz
LQH32NZ391J23□	LQH32NH391J23□	390μH ±5%	50	50mA/45mA	22.0Ω	12.4Ω±20%	5.0MHz
LQH32NZ471J23□	LQH32NH471J23□	470μH ±5%	50	45mA/40mA	25.0Ω	14.1Ω±20%	5.0MHz
—	LQH32NH561J23□	560μH ±5%	50	40mA	—	14.6Ω±20%	4.0MHz

Operating temp.range (LQH32NZ\_23 series): -40 to 105°C

Operating temp.range (LQH32NH\_23 series): -40 to 125°C

Inductance Test Frequency: 1MHz (1.0μH to 390μH), 1kHz (470μH to 560μH)

Q Test Frequency: 1MHz (1.0μH to 82μH), 796kHz (100μH to 560μH)

\*Max. of DC Resistance: LQH32NZ\_23 series

\*DC Resistance: LQH32NH\_23 series

Class of Magnetic Shield: No Shield

Only for reflow soldering

\*S.R.F: Self Resonant Frequency

When rated current is applied to the products, self-temperature rise shall be limited to 20°C max and inductance will be within ±10% of initial inductance value.

### Inductance-Frequency Characteristics (Typ.)

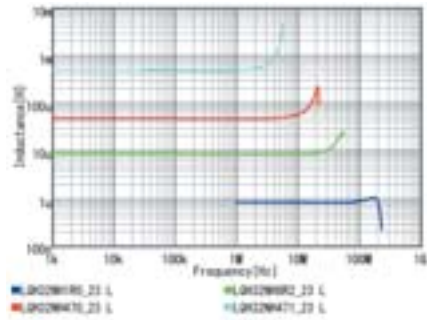

### Q-Frequency Characteristics (Typ.)

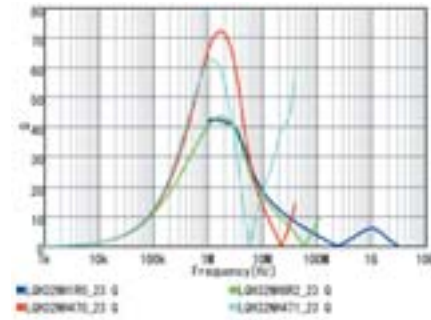

## Inductors for General Circuits

# LQH43NZ\_03 Series 1812 (4532) inch (mm)

### Appearance/Dimensions

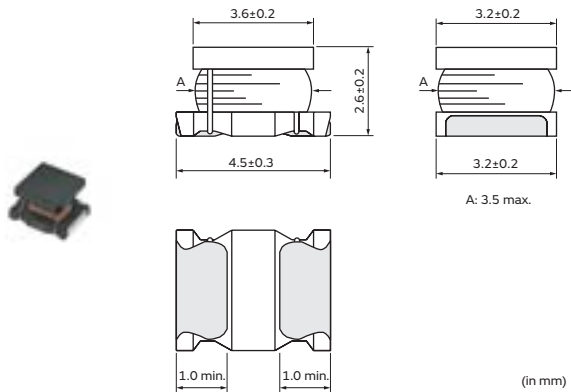

### Packaging

Code	Packaging	Minimum Quantity
K	ø330mm Embossed Taping	2500
L	ø180mm Embossed Taping	500

### Rated Value (□: packaging code)

Part Number		Inductance	Inductance Test Frequency	Q (min.)	Q Test Frequency	Rated Current	Max. of DC Resistance	S.R.F* (min.)
Infotainment	Powertrain/Safety							
LQH43NZ1R0M03□	—	1.0μH ±20%	1MHz	20	1MHz	500mA	0.20Ω	120MHz
LQH43NZ1R2M03□	—	1.2μH ±20%	1MHz	20	1MHz	500mA	0.20Ω	100MHz
LQH43NZ1R5M03□	—	1.5μH ±20%	1MHz	20	1MHz	500mA	0.30Ω	85MHz
LQH43NZ1R8M03□	—	1.8μH ±20%	1MHz	20	1MHz	500mA	0.30Ω	75MHz
LQH43NZ2R2M03□	—	2.2μH ±20%	1MHz	20	1MHz	500mA	0.30Ω	62MHz
LQH43NZ2R7M03□	—	2.7μH ±20%	1MHz	20	1MHz	500mA	0.32Ω	53MHz
LQH43NZ3R3M03□	—	3.3μH ±20%	1MHz	20	1MHz	500mA	0.35Ω	47MHz
LQH43NZ3R9M03□	—	3.9μH ±20%	1MHz	20	1MHz	500mA	0.38Ω	41MHz
LQH43NZ4R7K03□	—	4.7μH ±10%	1MHz	30	1MHz	500mA	0.40Ω	38MHz
LQH43NZ4R7M03□	—	4.7μH ±20%	1MHz	30	1MHz	500mA	0.40Ω	38MHz
LQH43NZ5R6K03□	—	5.6μH ±10%	1MHz	30	1MHz	500mA	0.47Ω	33MHz
LQH43NZ5R6M03□	—	5.6μH ±20%	1MHz	30	1MHz	500mA	0.47Ω	33MHz
LQH43NZ6R8K03□	—	6.8μH ±10%	1MHz	30	1MHz	450mA	0.50Ω	31MHz
LQH43NZ6R8M03□	—	6.8μH ±20%	1MHz	30	1MHz	450mA	0.50Ω	31MHz
LQH43NZ8R2K03□	—	8.2μH ±10%	1MHz	30	1MHz	450mA	0.56Ω	27MHz
LQH43NZ8R2M03□	—	8.2μH ±20%	1MHz	30	1MHz	450mA	0.56Ω	27MHz
LQH43NZ100J03□	—	10μH ±5%	1MHz	35	1MHz	400mA	0.56Ω	23MHz
LQH43NZ100K03□	—	10μH ±10%	1MHz	35	1MHz	400mA	0.56Ω	23MHz
LQH43NZ120J03□	—	12μH ±5%	1MHz	35	1MHz	380mA	0.62Ω	21MHz
LQH43NZ120K03□	—	12μH ±10%	1MHz	35	1MHz	380mA	0.62Ω	21MHz
LQH43NZ150J03□	—	15μH ±5%	1MHz	35	1MHz	360mA	0.73Ω	19MHz
LQH43NZ150K03□	—	15μH ±10%	1MHz	35	1MHz	360mA	0.73Ω	19MHz
LQH43NZ180J03□	—	18μH ±5%	1MHz	35	1MHz	340mA	0.82Ω	17MHz
LQH43NZ180K03□	—	18μH ±10%	1MHz	35	1MHz	340mA	0.82Ω	17MHz
LQH43NZ220J03□	—	22μH ±5%	1MHz	35	1MHz	320mA	0.94Ω	15MHz
LQH43NZ220K03□	—	22μH ±10%	1MHz	35	1MHz	320mA	0.94Ω	15MHz
LQH43NZ270J03□	—	27μH ±5%	1MHz	35	1MHz	300mA	1.1Ω	14MHz
LQH43NZ270K03□	—	27μH ±10%	1MHz	35	1MHz	300mA	1.1Ω	14MHz
LQH43NZ330J03□	—	33μH ±5%	1MHz	35	1MHz	270mA	1.2Ω	12MHz
LQH43NZ330K03□	—	33μH ±10%	1MHz	35	1MHz	270mA	1.2Ω	12MHz
LQH43NZ390J03□	—	39μH ±5%	1MHz	35	1MHz	240mA	1.4Ω	11MHz

Operating temp.range: -40 to 105°C

Class of Magnetic Shield: No Shield

Only for reflow soldering

\*S.R.F: Self Resonant Frequency

When rated current is applied to the products, self-temperature rise shall be limited to 20°C max and inductance will be within ±10% of initial inductance value.

Continued on the following page. ↗

Continued from the preceding page. ↘

Part Number		Inductance	Inductance Test Frequency	Q (min.)	Q Test Frequency	Rated Current	Max. of DC Resistance	S.R.F* (min.)
Infotainment	Powertrain/Safety							
LQH43NZ390K03□	—	39μH ±10%	1MHz	35	1MHz	240mA	1.4Ω	11MHz
LQH43NZ470J03□	—	47μH ±5%	1MHz	35	1MHz	220mA	1.5Ω	10MHz
LQH43NZ470K03□	—	47μH ±10%	1MHz	35	1MHz	220mA	1.5Ω	10MHz
LQH43NZ560J03□	—	56μH ±5%	1MHz	35	1MHz	200mA	1.7Ω	9.3MHz
LQH43NZ560K03□	—	56μH ±10%	1MHz	35	1MHz	200mA	1.7Ω	9.3MHz
LQH43NZ680J03□	—	68μH ±5%	1MHz	35	1MHz	180mA	1.9Ω	8.4MHz
LQH43NZ680K03□	—	68μH ±10%	1MHz	35	1MHz	180mA	1.9Ω	8.4MHz
LQH43NZ820J03□	—	82μH ±5%	1MHz	35	1MHz	170mA	2.2Ω	7.5MHz
LQH43NZ820K03□	—	82μH ±10%	1MHz	35	1MHz	170mA	2.2Ω	7.5MHz
LQH43NZ101J03□	—	100μH ±5%	1MHz	40	796kHz	160mA	2.5Ω	6.8MHz
LQH43NZ101K03□	—	100μH ±10%	1MHz	40	796kHz	160mA	2.5Ω	6.8MHz
LQH43NZ121J03□	—	120μH ±5%	1MHz	40	796kHz	150mA	3.0Ω	6.2MHz
LQH43NZ121K03□	—	120μH ±10%	1MHz	40	796kHz	150mA	3.0Ω	6.2MHz
LQH43NZ151J03□	—	150μH ±5%	1MHz	40	796kHz	130mA	3.7Ω	5.5MHz
LQH43NZ151K03□	—	150μH ±10%	1MHz	40	796kHz	130mA	3.7Ω	5.5MHz
LQH43NZ181J03□	—	180μH ±5%	1MHz	40	796kHz	120mA	4.5Ω	5.0MHz
LQH43NZ181K03□	—	180μH ±10%	1MHz	40	796kHz	120mA	4.5Ω	5.0MHz
LQH43NZ221J03□	—	220μH ±5%	1MHz	40	796kHz	110mA	5.4Ω	4.5MHz
LQH43NZ221K03□	—	220μH ±10%	1MHz	40	796kHz	110mA	5.4Ω	4.5MHz
LQH43NZ271J03□	—	270μH ±5%	1MHz	40	796kHz	100mA	6.8Ω	4.0MHz
LQH43NZ271K03□	—	270μH ±10%	1MHz	40	796kHz	100mA	6.8Ω	4.0MHz
LQH43NZ331J03□	—	330μH ±5%	1MHz	40	796kHz	95mA	8.2Ω	3.6MHz
LQH43NZ331K03□	—	330μH ±10%	1MHz	40	796kHz	95mA	8.2Ω	3.6MHz
LQH43NZ391J03□	—	390μH ±5%	1MHz	40	796kHz	90mA	9.7Ω	3.3MHz
LQH43NZ391K03□	—	390μH ±10%	1MHz	40	796kHz	90mA	9.7Ω	3.3MHz
LQH43NZ471J03□	—	470μH ±5%	1kHz	40	796kHz	80mA	11.8Ω	3.0MHz
LQH43NZ471K03□	—	470μH ±10%	1kHz	40	796kHz	80mA	11.8Ω	3.0MHz
LQH43NZ561J03□	—	560μH ±5%	1kHz	40	796kHz	70mA	14.5Ω	2.7MHz
LQH43NZ561K03□	—	560μH ±10%	1kHz	40	796kHz	70mA	14.5Ω	2.7MHz
LQH43NZ681J03□	—	680μH ±5%	1kHz	40	796kHz	65mA	17.0Ω	2.5MHz
LQH43NZ681K03□	—	680μH ±10%	1kHz	40	796kHz	65mA	17.0Ω	2.5MHz
LQH43NZ821J03□	—	820μH ±5%	1kHz	40	796kHz	60mA	20.5Ω	2.2MHz
LQH43NZ821K03□	—	820μH ±10%	1kHz	40	796kHz	60mA	20.5Ω	2.2MHz
LQH43NZ102J03□	—	1000μH ±5%	1kHz	40	252kHz	50mA	25.0Ω	2.0MHz
LQH43NZ102K03□	—	1000μH ±10%	1kHz	40	252kHz	50mA	25.0Ω	2.0MHz
LQH43NZ122J03□	—	1200μH ±5%	1kHz	40	252kHz	45mA	30.0Ω	1.8MHz
LQH43NZ122K03□	—	1200μH ±10%	1kHz	40	252kHz	45mA	30.0Ω	1.8MHz
LQH43NZ152J03□	—	1500μH ±5%	1kHz	40	252kHz	40mA	37.0Ω	1.6MHz
LQH43NZ152K03□	—	1500μH ±10%	1kHz	40	252kHz	40mA	37.0Ω	1.6MHz
LQH43NZ182J03□	—	1800μH ±5%	1kHz	40	252kHz	35mA	45.0Ω	1.5MHz
LQH43NZ182K03□	—	1800μH ±10%	1kHz	40	252kHz	35mA	45.0Ω	1.5MHz
LQH43NZ222J03□	—	2200μH ±5%	1kHz	40	252kHz	30mA	50.0Ω	1.3MHz
LQH43NZ222K03□	—	2200μH ±10%	1kHz	40	252kHz	30mA	50.0Ω	1.3MHz
LQH43NZ242J03□	—	2400μH ±5%	1kHz	40	252kHz	25mA	53.0Ω	1.2MHz
LQH43NZ242K03□	—	2400μH ±10%	1kHz	40	252kHz	25mA	53.0Ω	1.2MHz

Operating temp.range: -40 to 105°C

Class of Magnetic Shield: No Shield

Only for reflow soldering

\*S.R.F: Self Resonant Frequency

When rated current is applied to the products, self-temperature rise shall be limited to 20°C max and inductance will be within ±10% of initial inductance value.

Continued on the following page. ↗

Continued from the preceding page. ↘

### Inductance-Frequency Characteristics (Typ.)

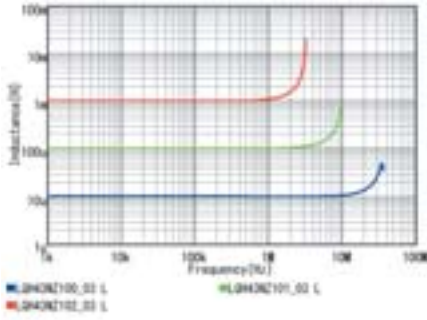

### Q-Frequency Characteristics (Typ.)

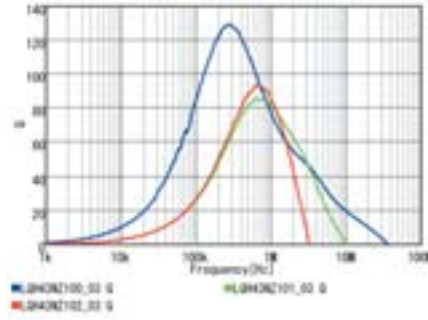

Inductors for Power Lines

Inductors for General Circuits

RF Inductors

# Inductors for General Circuits

## HEAWS Series 4241 (107104) inch (mm)

### Appearance/Dimensions

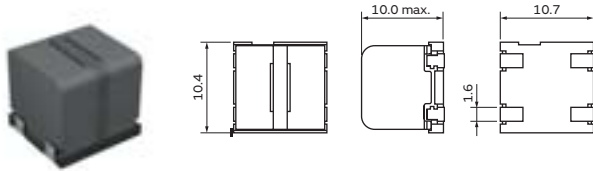

(in mm)

### Packaging

Code	Packaging	Minimum Quantity
=P3	ø330mm Embossed Taping	250

### Rated Value (□: packaging code)

Part Number		Inductance	Inductance Test Frequency	Rated Current (Isat)*	Rated Current (Itemp)*	Max. of DC Resistance
Infotainment	Powertrain/Safety					
1211EA-1004□	—	10μH ±20%	0.1MHz	5000mA	2800mA	0.025Ω

Operating temp.range (Self-temp.rise included): -40 to 125°C

Operating temp.range (Self-temp.rise not included): -40 to 85°C

Only for reflow soldering

\*Isat: Rated Current based on Inductance change

\*Itemp: Rated Current based on Temperature rise

Rated current (Isat) is specified when the decrease of the initial inductance value at 25%. (The ambient reference temperature is 20°C)

Rated current (Itemp) is specified when temperature of inductor the is raised 40°C by DC current. (The ambient reference temperature is 20°C)

Class of Magnetic Shield: Ferrite Core

### Inductance-Current Characteristics (Typ.)

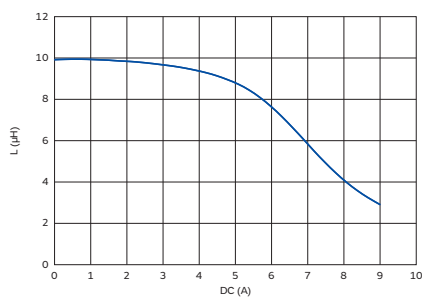

### Temperature Rise Characteristics (Typ.)

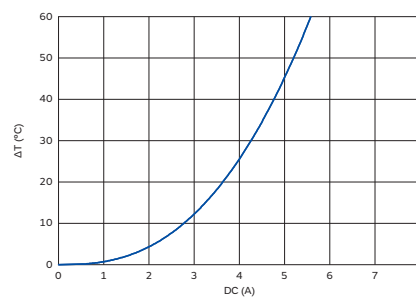

## Inductors for General Circuits

# HEAW Series 5551 (140130) inch (mm)

### Appearance/Dimensions

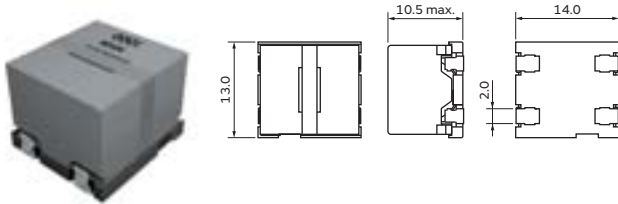

(in mm)

### Packaging

Code	Packaging	Minimum Quantity
=P3	ø330mm Embossed Taping	200

### Rated Value (□: packaging code)

Part Number		Inductance	Inductance Test Frequency	Rated Current (Isat)*	Rated Current (Itemp)*	Max. of DC Resistance
Infotainment	Powertrain/Safety					
1155EA-0001□	—	10μH ±20%	0.1MHz	7200mA	3000mA	0.025Ω

Operating temp.range (Self-temp.rise included): -40 to 125°C

Operating temp.range (Self-temp.rise not included): -40 to 85°C

Only for reflow soldering

\*Isat: Rated Current based on Inductance change

\*Itemp: Rated Current based on Temperature rise

Rated current (Isat) is specified when the decrease of the initial inductance value at 25%. (The ambient reference temperature is 20°C)

Rated current (Itemp) is specified when temperature of inductor the is raised 40°C by DC current. (The ambient reference temperature is 20°C)

Class of Magnetic Shield: Ferrite Core

### Inductance-Current Characteristics (Typ.)

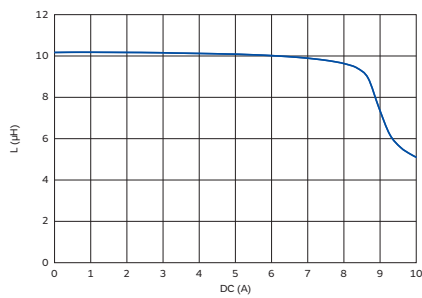

### Temperature Rise Characteristics (Typ.)

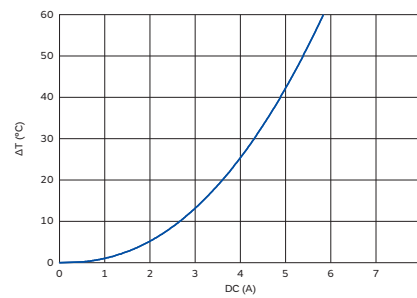

## Inductors for General Circuits

# Surface mount variable coil 5CCEG Series 2222 (5656) inch (mm)

### Appearance/Dimensions

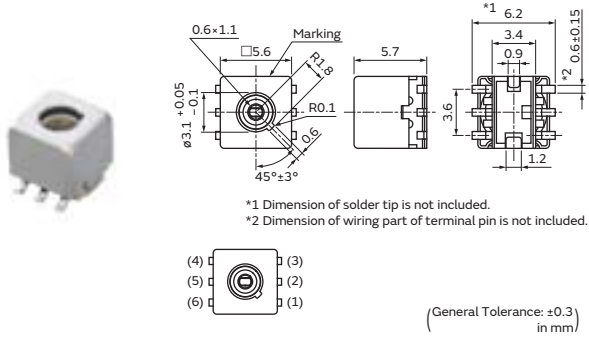

### Packaging

Code	Packaging	Minimum Quantity
=P3	ø330mm Embossed Taping	750

### Features

- 6.5×5.9×6.0(H) mm MAX.
- Supported inductance range: 0.05 to 2.7μH
- High reliability that conforms to automotive standards
- Operating temperature range: -40°C to +85°C

### Applications

- Ideal for use as RF matching transformers for car tuners

### Rated Value (□: packaging code)

Winding Connection (Bottom View)	Part Number		Test Frequency (MHz)	Resonance Capacitor Range (pF)
	Infotainment	Powertrain/Safety		
	#A1313AN-0001GGH□	—	100	11.4 +3/-3%
	#A1313AN-0002GRG□	—	100	11.4 +5/-2%
	#A1313AN-0003GRG□	—	100	11.4 +2/-4%
	#A1313AN-0004GGH□	—	100	11.7 +3/-3%

## Inductors for General Circuits

# Surface mount variable coil FSDVA Series 2323 (5858) inch (mm)

### Appearance/Dimensions

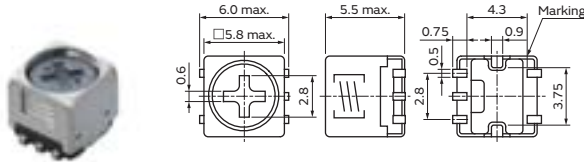

(General Tolerance: ±0.2 in mm)

### Packaging

Code	Packaging	Minimum Quantity
=P3	ø330mm Embossed Taping	1000

### Features

- 5.8×5.8×5.5(H) mm MAX.
- Supported inductance range: 0.1 to 52mH (1 to 7 mH for corner sensor applications)
- Resistant to mechanical stress
- Operating temperature range  
 Up to 20 mH (-40°C to +105°C)  
 20 mH or more (-40°C to +85°C)
- Various reliability conditions guaranteed for 1,000 hours (evaluation performed up to 3,000 hours)
- Lead coplanarity guaranteed within 0.1 mm

### Rated Value (□: packaging code)

Winding Connection (Bottom View)	Part Number		Test Frequency (kHz)	Inductance Range (mH)	Unloaded Q
	Infotainment	Powertrain/Safety			
	N1342BCA-0004UG□	—	252	4.4 ±3%	25 min
	N1342DEA-0008BQE□	—	252	2.5 ±5%	25 min

Winding Connection (Bottom View)	Part Number		Test Frequency (kHz)	Inductance Tolerance (mH)	Unloaded Q
	Infotainment	Powertrain/Safety			
	N1342AAA-0001Z□	—	79.6	52 ±7%	10 min



## Inductors for General Circuits (LQ Series) ⚠️Caution/Notice

### ⚠️Caution

#### Rating

##### 1. About the Rated Current

Do not use products beyond the rated current as this may create excessive heat and deteriorate the insulation resistance.

For the usage of powertrain and safety be sure to provide an appropriate fail-safe function on your product to prevent a second damage that may be caused by the abnormal function or the failure of our product.

##### 2. About Excessive Surge Current

Surge current (pulse current or rush current) greater than the specified rated current applied to the product may cause a critical failure, such as an open circuit, burnout caused by excessive temperature rise.

Please contact us in advance in case of applying the surge current.

### Notice

#### Storage and Operating Condition

##### <Operating Environment>

Do not use products in chemical atmosphere such as chlorine gas, acid or sulfide gas.

##### <Storage Requirements>

##### 1. Storage Period

Products should be used within 12 months.  
Check solderability if this period is exceeded.

##### 2. Storage Conditions

- (1) Store products in a warehouse in compliance with the following conditions:  
Temperature: -10 to +40 degrees C.  
Humidity: 15 to 85% (relative humidity)

Do not subject products to rapid changes in temperature and humidity.

Do not store them in chemical atmosphere such as one containing sulfurous acid gas or alkaline gas.  
This will prevent electrode oxidation, which causes poor solderability and possible corrosion of inductors.

- (2) Do not store products in bulk packaging to prevent collision among inductors, which causes core chipping and wire breakage.
- (3) Store products on pallets to protect from humidity, dust, etc.
- (4) Avoid heat shock, vibration, direct sunlight, etc.

#### Handling

This item is designed to have sufficient strength, but handle with care to avoid chipping or breaking its ceramic structure.

##### LQH series

- To prevent breaking the wire, avoid touching with sharp material, such as tweezers or the bristles of a cleaning brush, to the wire wound portion of this product.
- To prevent breaking the core, avoid applying excessive mechanical shock to products mounted on the board.

##### <Transportation>

Do not apply excessive vibration or mechanical shock to products.

##### <Resin Coating>

When coating products with resin, the relatively high resin curing stress may change inductance values.  
For exterior coating, select resin carefully so that electrical and mechanical performance of the product is not affected. Prior to use, please evaluate reliability with the product mounted in your application set.

##### (LQH series)

An open circuit issue may occur by mechanical stress caused by the resin, amount/cured shape of resin, or operating conditions, etc. Some resins containing impurities or chloride may possibly generate chlorine by hydrolysis under some operating conditions, causing corrosion of the inductor wire and leading to an open circuit.

##### <Handling of a Substrate>

After mounting products on a substrate, do not apply any stress to the product caused by bending or twisting the substrate when cropping the substrate, inserting and removing a connector from the substrate, or tightening a screw to the substrate.

Excessive mechanical stress may cause cracking in the Product.

Bending

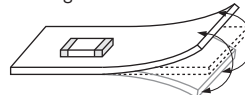

Twisting

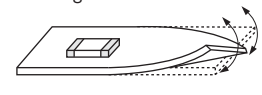

## Inductors for General (except for LQ Series) ⚠️Caution/Notice

### ⚠️Caution

#### Rating

##### 1. About the Rated Current

Do not use products beyond the rated current as this may create excessive heat and deteriorate the insulation resistance.

Be sure to provide an appropriate fail-safe function on your product to prevent a second damage that may be caused by the abnormal function or the failure of our product.

##### 2. About Excessive Surge Current

Surge current (pulse current or rush current) greater than the specified rated current applied to the product may cause a critical failure, such as an open circuit, burnout caused by excessive temperature rise. Please contact us in advance in case of applying the surge current.

### Notice

#### Precaution for Application

(1) The part must be pre-heated before soldering if reflow is applied.

The difference between pre-heat temperature and soldering temperature must be within 150°C.

(2) If a soldering iron is applied, the soldering process must be completed within 3 seconds at a soldering temperature lower than 350°C.

The tip of the soldering iron must not touch the terminal electrode in this process.

(3) Terminals should not be handled with fingers. This is to prevent deterioration in solderability.

(4) Soldering using a soldering iron must be done only once for each part.

(5) PCB mount: this part must be handled with care to minimize any physical stress to the part at the board assembly process.

(6) To minimize the influence to the part, the thickness of PCB, land dimension, and the amount of solder must be evaluated carefully by individual application.

(7) If a washing process is applied, please make sure there is no problem with operating.

(8) Products should not be dropped on the floor. This is to prevent damage to the products.

(9) Although electrical performance is satisfactory, audible noises may be made if audio frequency ingredient is contained in current.

Before using, please make sure there aren't any problem with operating.

#### Handling

##### ○Storage and Handling Requirements

###### (1) Storage period

Use the products within 6 months after delivered.

Solderability should be checked if this period is exceeded

###### (2) Storage conditions

• Products should be stored in the warehouse on the following conditions.

Temperature: -10 to 40°C

Humidity: 15 to 85% relative humidity No rapid change on temperature and humidity

Don't keep products in corrosive gases such as sulfur, chlorine gas or acid, or it may cause oxidization of electrode, resulting in poor solderability.

• Products should not be stored on bulk packaging condition to prevent the chipping of the core and the breaking of winding wire caused by the collision between the products.

• Products should be stored on the palette for the prevention of the influence from humidity, dust and so on.

• Products should be stored in the warehouse without heat shock, vibration, direct sunlight and so on.

###### (3) Handling Condition

Care should be taken when transporting or handling product to avoid excessive vibration or mechanical shock.

## Inductors for General Circuits Soldering and Mounting

### 1. Standard Land Pattern Dimensions

A high Q value is achieved when the PCB electrode land pattern is designed so that it does not project beyond the chip Inductors (chip coils) electrode.

■ Land Pattern + Solder Resist    ■ Land Pattern    □ Solder Resist  
 (in mm)

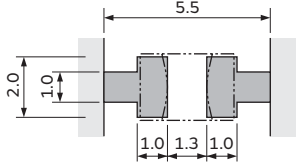
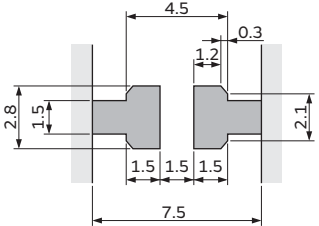
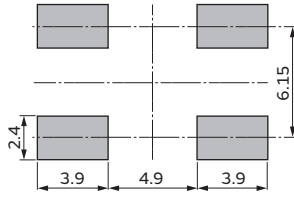
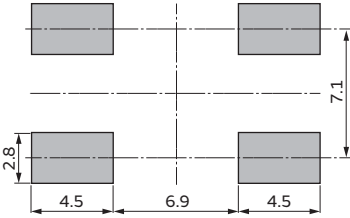
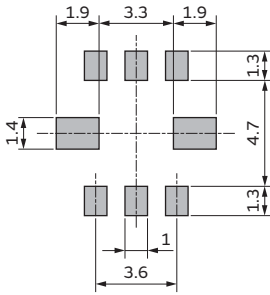
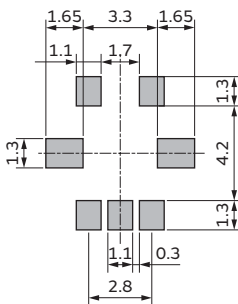
Series	Standard Land Dimensions
LQH32N	 <p>Diagram showing the standard land dimensions for the LQH32N series. The overall width is 5.5 mm. The central gap between the two main pads is 1.3 mm. The distance from the center to the edge of the main pads is 1.0 mm. The height of the main pads is 2.0 mm, and the height of the side pads is 1.0 mm.</p>
LQH43N	 <p>Diagram showing the standard land dimensions for the LQH43N series. The overall width is 7.5 mm. The distance between the centers of the two main pads is 4.5 mm. The height of the main pads is 2.8 mm. The distance from the center to the edge of the main pads is 1.5 mm. The height of the side pads is 1.2 mm. The distance from the center to the edge of the side pads is 2.1 mm. The gap between the main pads is 0.3 mm.</p>
HEAWS	 <p>Diagram showing the standard land dimensions for the HEAWS series. The overall width is 6.15 mm. The distance between the centers of the two main pads is 4.9 mm. The height of the main pads is 2.4 mm. The distance from the center to the edge of the main pads is 3.9 mm.</p>
HEAW	 <p>Diagram showing the standard land dimensions for the HEAW series. The overall width is 6.9 mm. The distance between the centers of the two main pads is 6.9 mm. The height of the main pads is 2.8 mm. The distance from the center to the edge of the main pads is 4.5 mm.</p>
5CCEG	 <p>Diagram showing the standard land dimensions for the 5CCEG series. The overall width is 3.6 mm. The distance between the centers of the two main pads is 3.3 mm. The height of the main pads is 1.4 mm. The distance from the center to the edge of the main pads is 1.9 mm. The height of the side pads is 1.3 mm. The distance from the center to the edge of the side pads is 4.7 mm. The gap between the main pads is 1 mm.</p>
FSDVA	 <p>Diagram showing the standard land dimensions for the FSDVA series. The overall width is 2.8 mm. The distance between the centers of the two main pads is 3.3 mm. The height of the main pads is 1.1 mm. The distance from the center to the edge of the main pads is 1.65 mm. The height of the side pads is 1.3 mm. The distance from the center to the edge of the side pads is 4.2 mm. The gap between the main pads is 1.7 mm. The distance from the center to the edge of the side pads is 1.3 mm. The height of the side pads is 1.3 mm. The distance from the center to the edge of the side pads is 0.3 mm.</p>

Attention should be paid to potential magnetic coupling effects when using the Inductors (coils) as a resonator.

Continued on the following page. ↗

## Inductors for General Circuits Soldering and Mounting

Continued from the preceding page. ↘

### 2. Standard Soldering Conditions

#### (1) Soldering method

Chip Inductors (Chip coils) can be reflow soldered.

Please contact Murata regarding other soldering methods.

Solder: Use Sn-3.0Ag-0.5Cu solder.

Flux: Use rosin-based flux, but not strongly acidic flux (with chlorine content exceeding 0.2wt%).

Do not use water-soluble flux.

For additional mounting methods, please contact Murata.

#### (2) Soldering profile

##### ● Reflow Soldering profile (LQ Series) (Sn-3.0Ag-0.5Cu solder)

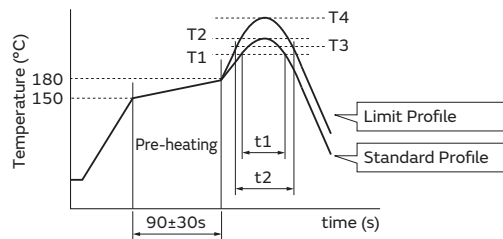

Series	Standard Profile				Limit Profile			
	Heating		Peak temperature (T2)	Cycle of reflow	Heating		Peak temperature (T4)	Cycle of reflow
	Temp. (T1)	Time. (t1)			Temp. (T3)	Time. (t2)		
<b>LQH32N/43N</b>	220°C	30 to 60s	245±3°C	2 times max.	230°C	60s max.	260°C/10s	2 times max.

Continued on the following page. ↗

## Inductors for General Circuits Soldering and Mounting

Continued from the preceding page. ↘

### ● Reflow Soldering profile (except for LQ Series) (Sn-3.0Ag-0.5Cu solder)

#### HEAWS HEAW

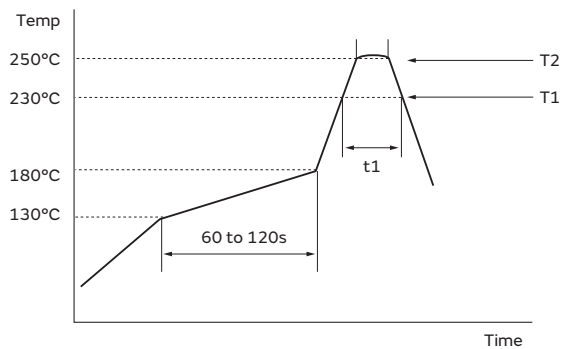

\*Preheat: Temperature 130 to 180°C, Time 60 to 120 sec

#### FSDVA 5CCEG

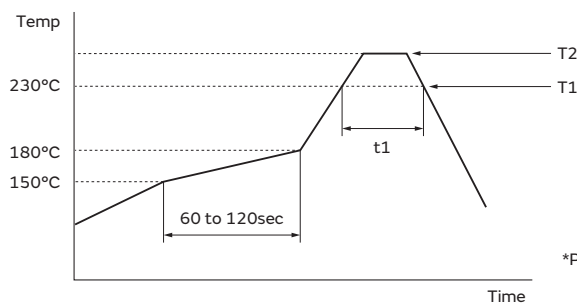

\*Preheat: Temperature 150 to 180°C, Time 60 to 120 sec

Series	Heating		Peak Temperature (T2)	Cycle of Reflow
	Temp. (T1)	Time (t1)		
HEAWS HEAW	230°C	60s	250 (+10/-0)°C/10s	2 times max.
FSDVA 5CCEG	230°C	40 to 60s	260°C/3s or 250°C/10s	2 times max.

### (3) Reworking with Soldering Iron (LQ Series)

Preheating at 150°C for 1 minute is required. Do not directly touch the products with the tip of the soldering iron in order to prevent the crack on the products due to the thermal shock.

- Soldering iron power output: 80W max.
- Temperature of soldering iron tip: 350°C
- Diameter of soldering iron end: 3.0mm max.
- Soldering time: within 3 s

Please keep the fix time with the soldering iron within 2 times

### Reworking with Soldering Iron (HEAWS/HEAW Series)

- Temperature of soldering iron tip: 390°C
- Soldering time: within 3±1 s

### Reworking with Soldering Iron (FSDVA/5CCEG Series)

Apply reflow soldering conditions when using soldering iron and for rework.

Especially be careful not to overheat the tip of the soldering iron.

Temperature of soldering iron tip: 360°C

Soldering time: within 3±1 s

Please keep the fix time with the soldering iron within 1 times.

Continued on the following page. ↗

## Inductors for General Circuits Soldering and Mounting

Continued from the preceding page. ↘

### 3. Mounting Instructions

#### (1) Land Pattern Dimensions

Large lands reduce Q of the mounted chip. Also, large protruding land areas (bordered by lines having dimensions 'c' and 'd' shown) cause floating and electrode leaching.

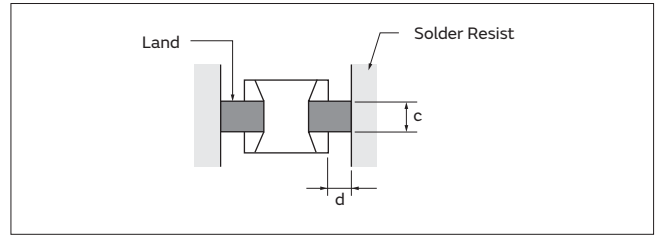

#### (2) Land Pattern Designing (LQH series)

Please follow the recommended patterns. Otherwise, their performance, which includes electrical performance or solderability, may be affected, or result in "position shift" in the soldering process.

#### (3) Magnetic Coupling

Since some chip inductors (chip coils) are constructed like an open magnetic circuit, narrow spacing between inductors (coils) may cause magnetic coupling.

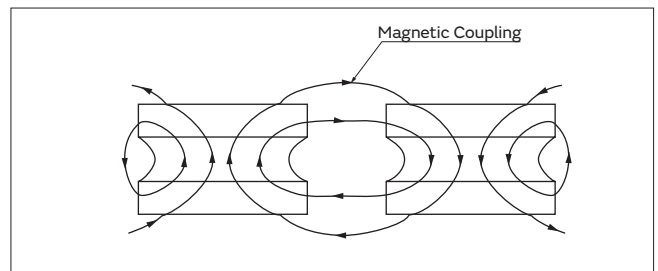

#### (4) PCB Warping

PCB should be designed so that products are not subjected to the mechanical stress caused by warping the board.

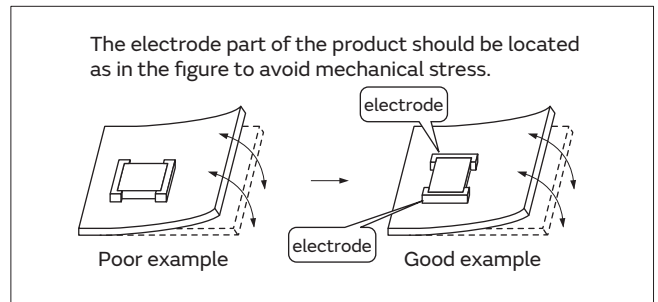
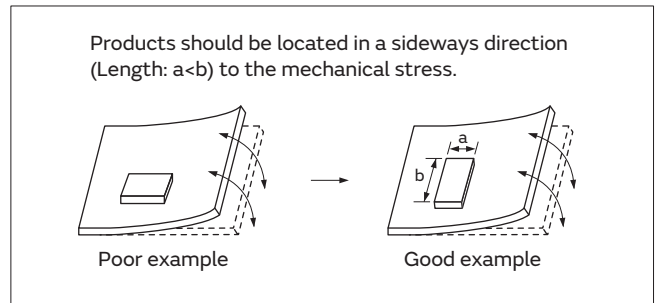

#### (5) Amount of Solder Paste

Excessive solder causes electrode corrosion, while insufficient solder causes low electrode bonding strength. Adjust the amount of solder paste as shown on the right so that solder is applied.

Guideline of solder paste thickness

LQH32N: 100 to 150 $\mu$ m

LQH43N: 200 to 300 $\mu$ m

5CCEG: 200 $\mu$ m

FSDVA: 150 to 200 $\mu$ m

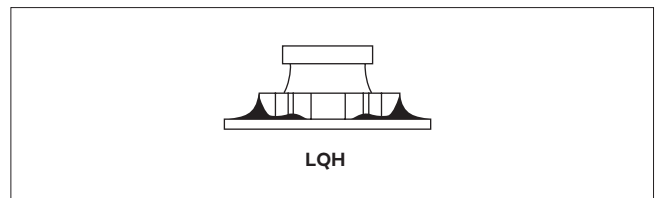

Continued on the following page. ↗

## Inductors for General Circuits Soldering and Mounting

Continued from the preceding page. ↘

### 4. Cleaning

The following conditions should be observed when cleaning chip inductors (chip coils):

(1) Cleaning Temperature: 60°C max. (40°C max. for alcohol cleaning agents)

(2) Ultrasonic

Output: 20W/l max.

Duration: 5 minutes max.

Frequency: 28 to 40kHz

Care should be taken not to cause resonance of the PCB and mounted products.

(3) Cleaning agent

The following cleaning agents have been tested on individual components. Evaluation in complete assembly should be done prior to production.

(a) Alcohol cleaning agents

Isopropyl alcohol (IPA)

(b) Aqueous cleaning agents

Pine Alpha ST-100S

(4) Ensure that flux residue is completely removed.

Component should be thoroughly dried after aqueous agents have been removed with deionized water.

For additional cleaning methods, please contact Murata.

## Inductors for General Circuits Packaging

### Minimum Quantity and 8mm Width Taping Dimensions

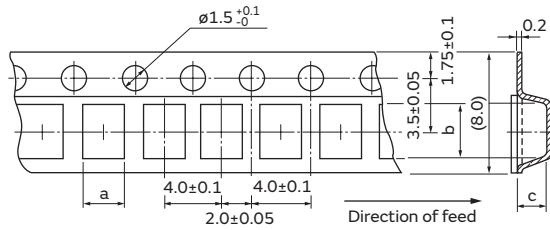

Dimension of the cavity of embossed tape is measured at the bottom side.

#### Embossed Tape

Part Number	Dimensions		Depth of Cavity	Packaging Code (Minimum Qty. [pcs.])		
	a	b		c	ø180mm reel	ø330mm reel
LQH32N	2.9	3.6	2.1	L (2000)	K (7500)	-

(in mm)

### Minimum Quantity and 12mm Width Embossed Taping Dimensions

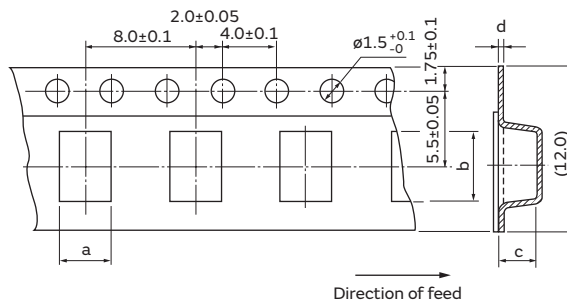

Dimension of the cavity of embossed tape is measured at the bottom side.

#### Embossed Tape

Part Number	Dimensions (c: Depth of Cavity)				Packaging Code (Minimum Qty. [pcs.])		
	a	b	c	d	ø180mm reel	ø330mm reel	Bulk
LQH43N	3.6	4.9	2.7	0.3	L (500)	K (2500)	-

(in mm)

Continued on the following page. ↗



# Inductors for General Circuits Packaging

Continued from the preceding page. ↘

## Taping for Automatic Insertion of SMT Coils

### Tape and Reel Dimensions

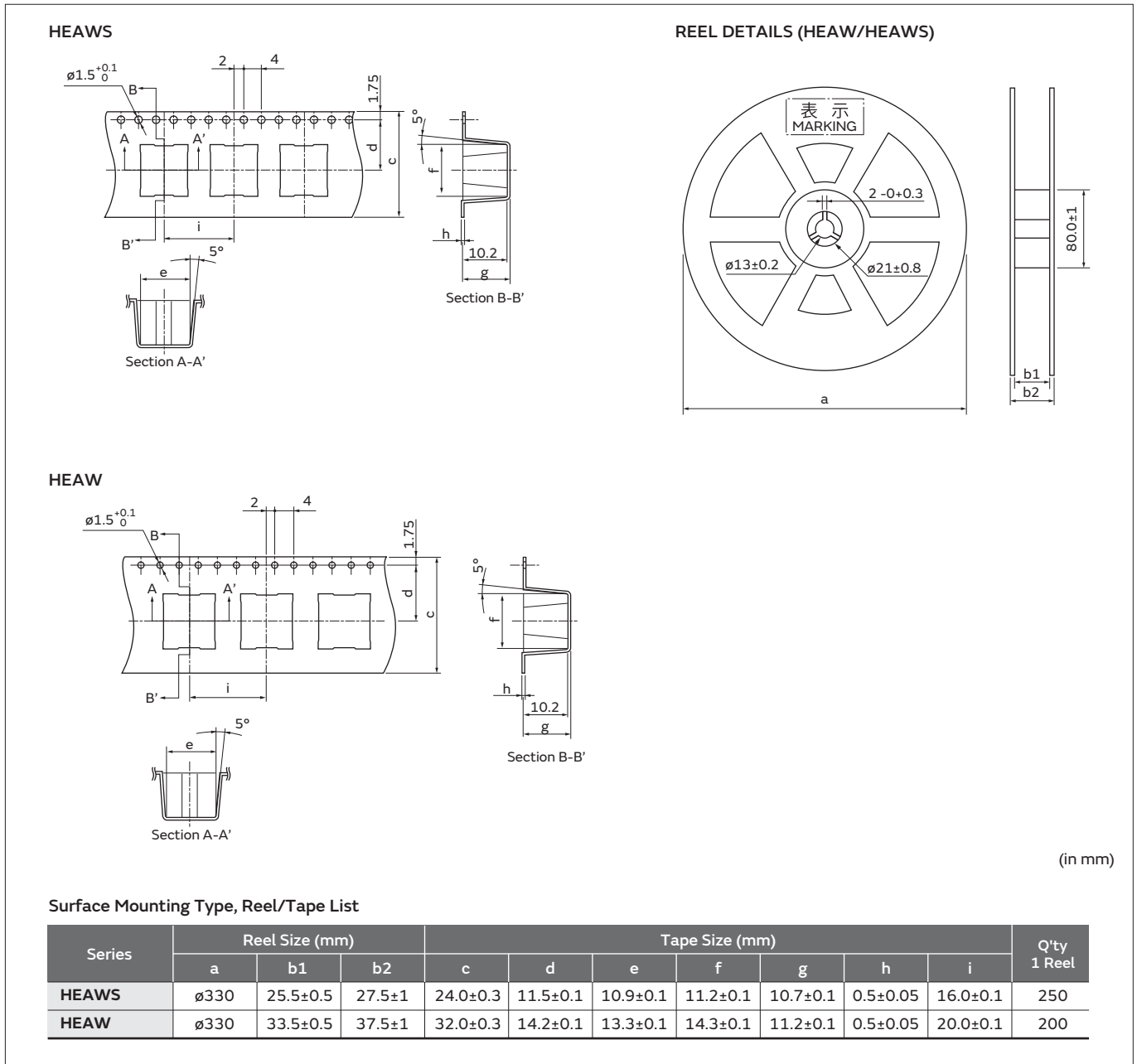

Continued on the following page. ↗

## Inductors for General Circuits Packaging

Continued from the preceding page. ↘

### Tape and Reel Dimensions

#### 5CCEG

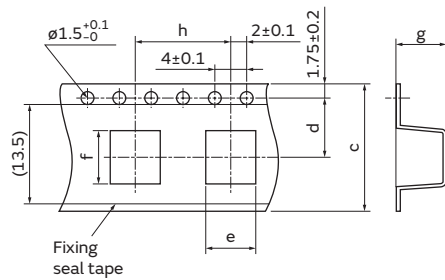

#### REEL DETAILS (5CCEG, FSDVA)

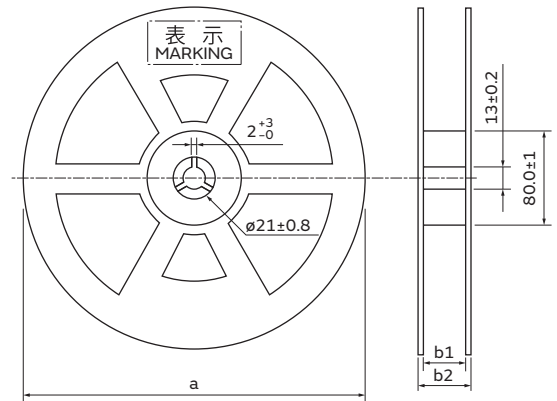

#### FSDVA

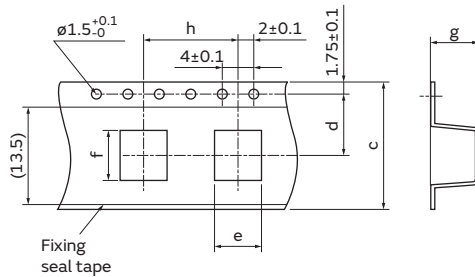

(in mm)

#### Surface Mounting Type, Reel/Tape List

Series	Reel Size (mm)			Tape Size (mm)						Q'ty 1 Reel
	a	b1	b2	c	d	e	f	g	h	
5CCEG	ø330	17.5±0.5	21.5±1	16.0±0.4	7.5±0.2	6.2±0.2	6.6±0.2	6.2±0.2	12±0.2	750
FSDVA	ø330	17.5±0.5	21.5±1	16.0±0.3	7.5±0.1	6.0±0.2	6.2±0.2	5.9±0.2	12±0.1	1,000

## ● Part Numbering

### RF Inductors for Automotive

(Part Number) 

LQ	G	15	H	H	1N0	S	0	2	D
①	②	③	④	⑤	⑥	⑦	⑧	⑨	⑩

#### ① Product ID

Product ID	
LQ	Chip Inductors (Chip Coils)

#### ② Structure

Code	Structure
G	Multilayer Type (Air-core Inductors (Coils))
H	Wire Wound Type (Ferrite Core)
P	Film Type
W	Wire Wound Type (Air-core Inductors (Coils))

#### ③ Dimensions (LxW)

Code	Nominal Dimensions (LxW)	Size Code (in inch)
03	0.6x0.3mm	0201
15	1.0x0.5mm	0402
18	1.6x0.8mm	0603
31	3.2x1.6mm	1206

#### ④ Applications and Characteristics

Code	Series	Applications and Characteristics
H	LQG	Multilayer Air-core Inductors (Coils)
W		High Q Type
T	LQP	Film Type (Low DC Resistance Type)
A	LQW	High Q Type (UHF-SHF)
C		for Choke (Coating Type)
H	LQH	for High-frequency Resonant Circuit

#### ⑤ Category

Code	Series	Category	
N	LQP/LQW	Standard Type	
S	LQW		
Z	LQG/LQH	Automotive	Infotainment
H	LQG		Powertrain/Safety

#### ⑥ Inductance

Expressed by three-digit alphanumerics. The unit is micro-henry ( $\mu\text{H}$ ). The first and second figures are significant digits, and the third figure expresses the number of zeros that follow the two figures. If there is a decimal point, it is expressed by the capital letter "R." In this case, all figures are significant digits. If inductance is less than  $0.1\mu\text{H}$ , the inductance code is expressed by a combination of two figures and the capital letter "N," and the unit of inductance is nano-henry (nH). The capital letter "N" indicates the unit of "nH," and also expresses a decimal point. In this case, all figures are significant digits. For those products whose inductance values are specified using three designated digits, these values may be indicated using the closest two digits instead.

#### ⑦ Inductance Tolerance

Code	Inductance Tolerance
B	$\pm 0.1\text{nH}$
C	$\pm 0.2\text{nH}$
D	$\pm 0.5\text{nH}$
G	$\pm 2\%$
H	$\pm 3\%$
J	$\pm 5\%$
K	$\pm 10\%$
S	$\pm 0.3\text{nH}$

#### ⑧ Features

Code	Features	Series
0	Standard Type	LQG/LQH/LQP/LQW
1	High-Q or Low DC Resistance	LQW15A/15C/18A
8	Low Resistance/ Large Current Type	LQW15A/18A
H	Automotive Powertrain/ Safety	LQP03T
Z	Automotive Infotainment	LQP03T

#### ⑨ Electrode

•Lead (Pb) Free

Code	Electrode	Series
0	Sn	LQG18H
2		LQG15H/LQG15W/LQP03T
3	LF Solder	LQH
Z	Automotive Infotainment	LQW15A/15C/18A/18C

#### ⑩ Packaging

Code	Packaging
K	Embossed Taping ( $\varnothing 330\text{mm}$ Reel)
L	Embossed Taping ( $\varnothing 180\text{mm}$ Reel)
B	Bulk
J	Paper Taping ( $\varnothing 330\text{mm}$ Reel)
D	Paper Taping ( $\varnothing 180\text{mm}$ Reel)

## RF Inductors

# LQG15HZ\_02/LQG15HH\_02 Series 0402 (1005) inch (mm)

### Appearance/Dimensions

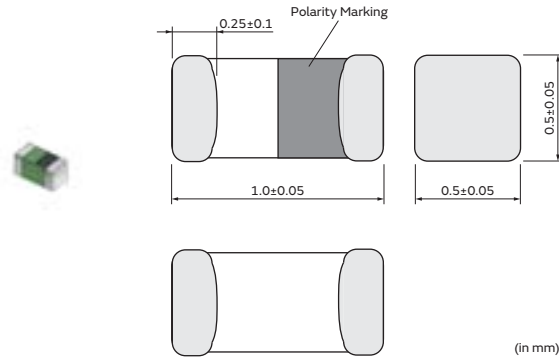

### Packaging

Code	Packaging	Minimum Quantity
D	ø180mm Paper Taping	10000
J	ø330mm Paper Taping	50000
B	Packing in Bulk	1000

### Rated Value (□: packaging code)

Part Number		Inductance	Inductance Test Frequency	Q (min.)	Q Test Frequency	Rated Current	Max. of DC Resistance	S.R.F* (min.)
Infotainment	Powertrain/Safety							
LQG15HZ1N0B02□	LQG15HH1N0B02□	1.0nH ±0.1nH	100MHz	8	100MHz	1000mA	0.07Ω	10000MHz
LQG15HZ1N0C02□	LQG15HH1N0C02□	1.0nH ±0.2nH	100MHz	8	100MHz	1000mA	0.07Ω	10000MHz
LQG15HZ1N0S02□	LQG15HH1N0S02□	1.0nH ±0.3nH	100MHz	8	100MHz	1000mA	0.07Ω	10000MHz
LQG15HZ1N1B02□	LQG15HH1N1B02□	1.1nH ±0.1nH	100MHz	8	100MHz	1000mA	0.07Ω	6000MHz
LQG15HZ1N1C02□	LQG15HH1N1C02□	1.1nH ±0.2nH	100MHz	8	100MHz	1000mA	0.07Ω	6000MHz
LQG15HZ1N1S02□	LQG15HH1N1S02□	1.1nH ±0.3nH	100MHz	8	100MHz	1000mA	0.07Ω	6000MHz
LQG15HZ1N2B02□	LQG15HH1N2B02□	1.2nH ±0.1nH	100MHz	8	100MHz	1000mA	0.07Ω	6000MHz
LQG15HZ1N2C02□	LQG15HH1N2C02□	1.2nH ±0.2nH	100MHz	8	100MHz	1000mA	0.07Ω	6000MHz
LQG15HZ1N2S02□	LQG15HH1N2S02□	1.2nH ±0.3nH	100MHz	8	100MHz	1000mA	0.07Ω	6000MHz
LQG15HZ1N3B02□	LQG15HH1N3B02□	1.3nH ±0.1nH	100MHz	8	100MHz	1000mA	0.07Ω	6000MHz
LQG15HZ1N3C02□	LQG15HH1N3C02□	1.3nH ±0.2nH	100MHz	8	100MHz	1000mA	0.07Ω	6000MHz
LQG15HZ1N3S02□	LQG15HH1N3S02□	1.3nH ±0.3nH	100MHz	8	100MHz	1000mA	0.07Ω	6000MHz
LQG15HZ1N5B02□	LQG15HH1N5B02□	1.5nH ±0.1nH	100MHz	8	100MHz	1000mA	0.07Ω	6000MHz
LQG15HZ1N5C02□	LQG15HH1N5C02□	1.5nH ±0.2nH	100MHz	8	100MHz	1000mA	0.07Ω	6000MHz
LQG15HZ1N5S02□	LQG15HH1N5S02□	1.5nH ±0.3nH	100MHz	8	100MHz	1000mA	0.07Ω	6000MHz
LQG15HZ1N6B02□	LQG15HH1N6B02□	1.6nH ±0.1nH	100MHz	8	100MHz	1000mA	0.07Ω	6000MHz
LQG15HZ1N6C02□	LQG15HH1N6C02□	1.6nH ±0.2nH	100MHz	8	100MHz	1000mA	0.07Ω	6000MHz
LQG15HZ1N6S02□	LQG15HH1N6S02□	1.6nH ±0.3nH	100MHz	8	100MHz	1000mA	0.07Ω	6000MHz
LQG15HZ1N8B02□	LQG15HH1N8B02□	1.8nH ±0.1nH	100MHz	8	100MHz	950mA	0.08Ω	6000MHz
LQG15HZ1N8C02□	LQG15HH1N8C02□	1.8nH ±0.2nH	100MHz	8	100MHz	950mA	0.08Ω	6000MHz
LQG15HZ1N8S02□	LQG15HH1N8S02□	1.8nH ±0.3nH	100MHz	8	100MHz	950mA	0.08Ω	6000MHz
LQG15HZ2N0B02□	LQG15HH2N0B02□	2.0nH ±0.1nH	100MHz	8	100MHz	900mA	0.09Ω	6000MHz
LQG15HZ2N0C02□	LQG15HH2N0C02□	2.0nH ±0.2nH	100MHz	8	100MHz	900mA	0.09Ω	6000MHz
LQG15HZ2N0S02□	LQG15HH2N0S02□	2.0nH ±0.3nH	100MHz	8	100MHz	900mA	0.09Ω	6000MHz
LQG15HZ2N2B02□	LQG15HH2N2B02□	2.2nH ±0.1nH	100MHz	8	100MHz	900mA	0.09Ω	6000MHz
LQG15HZ2N2C02□	LQG15HH2N2C02□	2.2nH ±0.2nH	100MHz	8	100MHz	900mA	0.09Ω	6000MHz
LQG15HZ2N2S02□	LQG15HH2N2S02□	2.2nH ±0.3nH	100MHz	8	100MHz	900mA	0.09Ω	6000MHz
LQG15HZ2N4B02□	LQG15HH2N4B02□	2.4nH ±0.1nH	100MHz	8	100MHz	850mA	0.11Ω	6000MHz
LQG15HZ2N4C02□	LQG15HH2N4C02□	2.4nH ±0.2nH	100MHz	8	100MHz	850mA	0.11Ω	6000MHz
LQG15HZ2N4S02□	LQG15HH2N4S02□	2.4nH ±0.3nH	100MHz	8	100MHz	850mA	0.11Ω	6000MHz
LQG15HZ2N7B02□	LQG15HH2N7B02□	2.7nH ±0.1nH	100MHz	8	100MHz	800mA	0.12Ω	6000MHz
LQG15HZ2N7C02□	LQG15HH2N7C02□	2.7nH ±0.2nH	100MHz	8	100MHz	800mA	0.12Ω	6000MHz

Operating temp.range (Self-temp.rise not included): -55 to 125°C

Only for reflow soldering

\*S.R.F: Self Resonant Frequency

Continued on the following page. ↗

Continued from the preceding page. ↘

Part Number		Inductance	Inductance Test Frequency	Q (min.)	Q Test Frequency	Rated Current	Max. of DC Resistance	S.R.F* (min.)
Infotainment	Powertrain/Safety							
LQG15HZ2N7S02□	LQG15HH2N7S02□	2.7nH ±0.3nH	100MHz	8	100MHz	800mA	0.12Ω	6000MHz
LQG15HZ3N0B02□	LQG15HH3N0B02□	3.0nH ±0.1nH	100MHz	8	100MHz	800mA	0.125Ω	6000MHz
LQG15HZ3N0C02□	LQG15HH3N0C02□	3.0nH ±0.2nH	100MHz	8	100MHz	800mA	0.125Ω	6000MHz
LQG15HZ3N0S02□	LQG15HH3N0S02□	3.0nH ±0.3nH	100MHz	8	100MHz	800mA	0.125Ω	6000MHz
LQG15HZ3N3B02□	LQG15HH3N3B02□	3.3nH ±0.1nH	100MHz	8	100MHz	800mA	0.125Ω	6000MHz
LQG15HZ3N3C02□	LQG15HH3N3C02□	3.3nH ±0.2nH	100MHz	8	100MHz	800mA	0.125Ω	6000MHz
LQG15HZ3N3S02□	LQG15HH3N3S02□	3.3nH ±0.3nH	100MHz	8	100MHz	800mA	0.125Ω	6000MHz
LQG15HZ3N6B02□	LQG15HH3N6B02□	3.6nH ±0.1nH	100MHz	8	100MHz	750mA	0.14Ω	6000MHz
LQG15HZ3N6C02□	LQG15HH3N6C02□	3.6nH ±0.2nH	100MHz	8	100MHz	750mA	0.14Ω	6000MHz
LQG15HZ3N6S02□	LQG15HH3N6S02□	3.6nH ±0.3nH	100MHz	8	100MHz	750mA	0.14Ω	6000MHz
LQG15HZ3N9B02□	LQG15HH3N9B02□	3.9nH ±0.1nH	100MHz	8	100MHz	750mA	0.14Ω	6000MHz
LQG15HZ3N9C02□	LQG15HH3N9C02□	3.9nH ±0.2nH	100MHz	8	100MHz	750mA	0.14Ω	6000MHz
LQG15HZ3N9S02□	LQG15HH3N9S02□	3.9nH ±0.3nH	100MHz	8	100MHz	750mA	0.14Ω	6000MHz
LQG15HZ4N3B02□	LQG15HH4N3B02□	4.3nH ±0.1nH	100MHz	8	100MHz	750mA	0.14Ω	6000MHz
LQG15HZ4N3C02□	LQG15HH4N3C02□	4.3nH ±0.2nH	100MHz	8	100MHz	750mA	0.14Ω	6000MHz
LQG15HZ4N3S02□	LQG15HH4N3S02□	4.3nH ±0.3nH	100MHz	8	100MHz	750mA	0.14Ω	6000MHz
LQG15HZ4N7B02□	LQG15HH4N7B02□	4.7nH ±0.1nH	100MHz	8	100MHz	700mA	0.16Ω	6000MHz
LQG15HZ4N7C02□	LQG15HH4N7C02□	4.7nH ±0.2nH	100MHz	8	100MHz	700mA	0.16Ω	6000MHz
LQG15HZ4N7S02□	LQG15HH4N7S02□	4.7nH ±0.3nH	100MHz	8	100MHz	700mA	0.16Ω	6000MHz
LQG15HZ5N1B02□	LQG15HH5N1B02□	5.1nH ±0.1nH	100MHz	8	100MHz	650mA	0.18Ω	5300MHz
LQG15HZ5N1C02□	LQG15HH5N1C02□	5.1nH ±0.2nH	100MHz	8	100MHz	650mA	0.18Ω	5300MHz
LQG15HZ5N1S02□	LQG15HH5N1S02□	5.1nH ±0.3nH	100MHz	8	100MHz	650mA	0.18Ω	5300MHz
LQG15HZ5N6B02□	LQG15HH5N6B02□	5.6nH ±0.1nH	100MHz	8	100MHz	650mA	0.18Ω	4500MHz
LQG15HZ5N6C02□	LQG15HH5N6C02□	5.6nH ±0.2nH	100MHz	8	100MHz	650mA	0.18Ω	4500MHz
LQG15HZ5N6S02□	LQG15HH5N6S02□	5.6nH ±0.3nH	100MHz	8	100MHz	650mA	0.18Ω	4500MHz
LQG15HZ6N2B02□	LQG15HH6N2B02□	6.2nH ±0.1nH	100MHz	8	100MHz	600mA	0.20Ω	4500MHz
LQG15HZ6N2C02□	LQG15HH6N2C02□	6.2nH ±0.2nH	100MHz	8	100MHz	600mA	0.20Ω	4500MHz
LQG15HZ6N2S02□	LQG15HH6N2S02□	6.2nH ±0.3nH	100MHz	8	100MHz	600mA	0.20Ω	4500MHz
LQG15HZ6N8G02□	LQG15HH6N8G02□	6.8nH ±2%	100MHz	8	100MHz	600mA	0.22Ω	4500MHz
LQG15HZ6N8H02□	LQG15HH6N8H02□	6.8nH ±3%	100MHz	8	100MHz	600mA	0.22Ω	4500MHz
LQG15HZ6N8J02□	LQG15HH6N8J02□	6.8nH ±5%	100MHz	8	100MHz	600mA	0.22Ω	4500MHz
LQG15HZ7N5G02□	LQG15HH7N5G02□	7.5nH ±2%	100MHz	8	100MHz	550mA	0.24Ω	4200MHz
LQG15HZ7N5H02□	LQG15HH7N5H02□	7.5nH ±3%	100MHz	8	100MHz	550mA	0.24Ω	4200MHz
LQG15HZ7N5J02□	LQG15HH7N5J02□	7.5nH ±5%	100MHz	8	100MHz	550mA	0.24Ω	4200MHz
LQG15HZ8N2G02□	LQG15HH8N2G02□	8.2nH ±2%	100MHz	8	100MHz	550mA	0.24Ω	3700MHz
LQG15HZ8N2H02□	LQG15HH8N2H02□	8.2nH ±3%	100MHz	8	100MHz	550mA	0.24Ω	3700MHz
LQG15HZ8N2J02□	LQG15HH8N2J02□	8.2nH ±5%	100MHz	8	100MHz	550mA	0.24Ω	3700MHz
LQG15HZ9N1G02□	LQG15HH9N1G02□	9.1nH ±2%	100MHz	8	100MHz	500mA	0.26Ω	3400MHz
LQG15HZ9N1H02□	LQG15HH9N1H02□	9.1nH ±3%	100MHz	8	100MHz	500mA	0.26Ω	3400MHz
LQG15HZ9N1J02□	LQG15HH9N1J02□	9.1nH ±5%	100MHz	8	100MHz	500mA	0.26Ω	3400MHz
LQG15HZ10NG02□	LQG15HH10NG02□	10nH ±2%	100MHz	8	100MHz	500mA	0.26Ω	3400MHz
LQG15HZ10NH02□	LQG15HH10NH02□	10nH ±3%	100MHz	8	100MHz	500mA	0.26Ω	3400MHz
LQG15HZ10NJ02□	LQG15HH10NJ02□	10nH ±5%	100MHz	8	100MHz	500mA	0.26Ω	3400MHz
LQG15HZ12NG02□	LQG15HH12NG02□	12nH ±2%	100MHz	8	100MHz	500mA	0.28Ω	3000MHz
LQG15HZ12NH02□	LQG15HH12NH02□	12nH ±3%	100MHz	8	100MHz	500mA	0.28Ω	3000MHz
LQG15HZ12NJ02□	LQG15HH12NJ02□	12nH ±5%	100MHz	8	100MHz	500mA	0.28Ω	3000MHz
LQG15HZ15NG02□	LQG15HH15NG02□	15nH ±2%	100MHz	8	100MHz	450mA	0.32Ω	2500MHz
LQG15HZ15NH02□	LQG15HH15NH02□	15nH ±3%	100MHz	8	100MHz	450mA	0.32Ω	2500MHz
LQG15HZ15NJ02□	LQG15HH15NJ02□	15nH ±5%	100MHz	8	100MHz	450mA	0.32Ω	2500MHz
LQG15HZ18NG02□	LQG15HH18NG02□	18nH ±2%	100MHz	8	100MHz	400mA	0.36Ω	2200MHz
LQG15HZ18NH02□	LQG15HH18NH02□	18nH ±3%	100MHz	8	100MHz	400mA	0.36Ω	2200MHz
LQG15HZ18NJ02□	LQG15HH18NJ02□	18nH ±5%	100MHz	8	100MHz	400mA	0.36Ω	2200MHz
LQG15HZ22NG02□	LQG15HH22NG02□	22nH ±2%	100MHz	8	100MHz	350mA	0.42Ω	1900MHz

Operating temp.range (Self-temp.rise not included): -55 to 125°C

Only for reflow soldering

\*S.R.F: Self Resonant Frequency

Continued on the following page. ↗

Inductors for Power Lines

Inductors for General Circuits

RF Inductors

Continued from the preceding page. ↘

Part Number		Inductance	Inductance Test Frequency	Q (min.)	Q Test Frequency	Rated Current	Max. of DC Resistance	S.R.F* (min.)
Infotainment	Powertrain/Safety							
LQG15HZ22NH02□	LQG15HH22NH02□	22nH ±3%	100MHz	8	100MHz	350mA	0.42Ω	1900MHz
LQG15HZ22NJ02□	LQG15HH22NJ02□	22nH ±5%	100MHz	8	100MHz	350mA	0.42Ω	1900MHz
LQG15HZ27NG02□	LQG15HH27NG02□	27nH ±2%	100MHz	8	100MHz	350mA	0.46Ω	1700MHz
LQG15HZ27NH02□	LQG15HH27NH02□	27nH ±3%	100MHz	8	100MHz	350mA	0.46Ω	1700MHz
LQG15HZ27NJ02□	LQG15HH27NJ02□	27nH ±5%	100MHz	8	100MHz	350mA	0.46Ω	1700MHz
LQG15HZ33NG02□	LQG15HH33NG02□	33nH ±2%	100MHz	8	100MHz	350mA	0.58Ω	1600MHz
LQG15HZ33NH02□	LQG15HH33NH02□	33nH ±3%	100MHz	8	100MHz	350mA	0.58Ω	1600MHz
LQG15HZ33NJ02□	LQG15HH33NJ02□	33nH ±5%	100MHz	8	100MHz	350mA	0.58Ω	1600MHz
LQG15HZ39NG02□	LQG15HH39NG02□	39nH ±2%	100MHz	8	100MHz	300mA	0.65Ω	1200MHz
LQG15HZ39NH02□	LQG15HH39NH02□	39nH ±3%	100MHz	8	100MHz	300mA	0.65Ω	1200MHz
LQG15HZ39NJ02□	LQG15HH39NJ02□	39nH ±5%	100MHz	8	100MHz	300mA	0.65Ω	1200MHz
LQG15HZ47NG02□	LQG15HH47NG02□	47nH ±2%	100MHz	8	100MHz	300mA	0.72Ω	1000MHz
LQG15HZ47NH02□	LQG15HH47NH02□	47nH ±3%	100MHz	8	100MHz	300mA	0.72Ω	1000MHz
LQG15HZ47NJ02□	LQG15HH47NJ02□	47nH ±5%	100MHz	8	100MHz	300mA	0.72Ω	1000MHz
LQG15HZ56NG02□	LQG15HH56NG02□	56nH ±2%	100MHz	8	100MHz	250mA	0.82Ω	800MHz
LQG15HZ56NH02□	LQG15HH56NH02□	56nH ±3%	100MHz	8	100MHz	250mA	0.82Ω	800MHz
LQG15HZ56NJ02□	LQG15HH56NJ02□	56nH ±5%	100MHz	8	100MHz	250mA	0.82Ω	800MHz
LQG15HZ68NG02□	LQG15HH68NG02□	68nH ±2%	100MHz	8	100MHz	250mA	0.92Ω	800MHz
LQG15HZ68NH02□	LQG15HH68NH02□	68nH ±3%	100MHz	8	100MHz	250mA	0.92Ω	800MHz
LQG15HZ68NJ02□	LQG15HH68NJ02□	68nH ±5%	100MHz	8	100MHz	250mA	0.92Ω	800MHz
LQG15HZ82NG02□	LQG15HH82NG02□	82nH ±2%	100MHz	8	100MHz	200mA	1.20Ω	700MHz
LQG15HZ82NH02□	LQG15HH82NH02□	82nH ±3%	100MHz	8	100MHz	200mA	1.20Ω	700MHz
LQG15HZ82NJ02□	LQG15HH82NJ02□	82nH ±5%	100MHz	8	100MHz	200mA	1.20Ω	700MHz
LQG15HZR10G02□	LQG15HHR10G02□	100nH ±2%	100MHz	8	100MHz	200mA	1.25Ω	600MHz
LQG15HZR10H02□	LQG15HHR10H02□	100nH ±3%	100MHz	8	100MHz	200mA	1.25Ω	600MHz
LQG15HZR10J02□	LQG15HHR10J02□	100nH ±5%	100MHz	8	100MHz	200mA	1.25Ω	600MHz
LQG15HZR12G02□	LQG15HHR12G02□	120nH ±2%	100MHz	8	100MHz	200mA	1.30Ω	600MHz
LQG15HZR12H02□	LQG15HHR12H02□	120nH ±3%	100MHz	8	100MHz	200mA	1.30Ω	600MHz
LQG15HZR12J02□	LQG15HHR12J02□	120nH ±5%	100MHz	8	100MHz	200mA	1.30Ω	600MHz
LQG15HZR15G02□	LQG15HHR15G02□	150nH ±2%	100MHz	8	100MHz	150mA	2.99Ω	550MHz
LQG15HZR15H02□	LQG15HHR15H02□	150nH ±3%	100MHz	8	100MHz	150mA	2.99Ω	550MHz
LQG15HZR15J02□	LQG15HHR15J02□	150nH ±5%	100MHz	8	100MHz	150mA	2.99Ω	550MHz
LQG15HZR18G02□	LQG15HHR18G02□	180nH ±2%	100MHz	8	100MHz	150mA	3.38Ω	500MHz
LQG15HZR18H02□	LQG15HHR18H02□	180nH ±3%	100MHz	8	100MHz	150mA	3.38Ω	500MHz
LQG15HZR18J02□	LQG15HHR18J02□	180nH ±5%	100MHz	8	100MHz	150mA	3.38Ω	500MHz
LQG15HZR22G02□	LQG15HHR22G02□	220nH ±2%	100MHz	8	100MHz	120mA	3.77Ω	450MHz
LQG15HZR22H02□	LQG15HHR22H02□	220nH ±3%	100MHz	8	100MHz	120mA	3.77Ω	450MHz
LQG15HZR22J02□	LQG15HHR22J02□	220nH ±5%	100MHz	8	100MHz	120mA	3.77Ω	450MHz
LQG15HZR27G02□	LQG15HHR27G02□	270nH ±2%	100MHz	8	100MHz	110mA	4.94Ω	400MHz
LQG15HZR27H02□	LQG15HHR27H02□	270nH ±3%	100MHz	8	100MHz	110mA	4.94Ω	400MHz
LQG15HZR27J02□	LQG15HHR27J02□	270nH ±5%	100MHz	8	100MHz	110mA	4.94Ω	400MHz

Operating temp.range (Self-temp.rise not included): -55 to 125°C

Only for reflow soldering

\*S.R.F: Self Resonant Frequency

Inductance-Frequency Characteristics (Typ.)

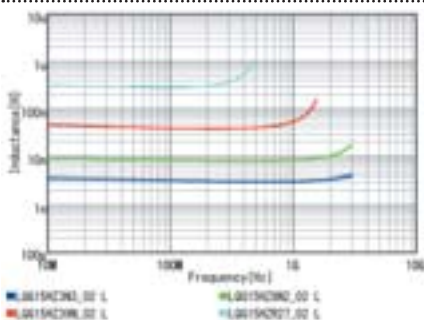

Q-Frequency Characteristics (Typ.)

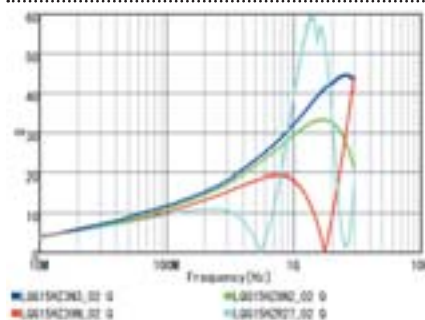

# RF Inductors

## LQG15WZ\_02/LQG15WH\_02 Series 0402 (1005) inch (mm)

### Appearance/Dimensions

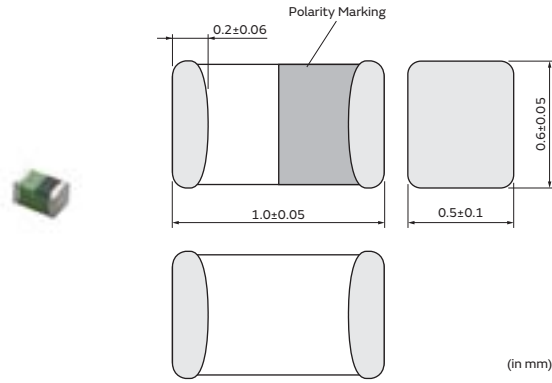

### Packaging

Code	Packaging	Minimum Quantity
D	ø180mm Paper Taping	10000
J	ø330mm Paper Taping	40000
B	Packing in Bulk	100

### Rated Value (□: packaging code)

Part Number		Inductance	Inductance Test Frequency	Q (min.)	Q Test Frequency	Rated Current	Max. of DC Resistance	S.R.F* (min.)
Infotainment	Powertrain/Safety							
LQG15WZ0N7B02□	LQG15WH0N7B02□	0.7nH ±0.1nH	100MHz	-	250MHz	1200mA	0.03Ω	15000MHz
LQG15WZ0N7C02□	LQG15WH0N7C02□	0.7nH ±0.2nH	100MHz	-	250MHz	1200mA	0.03Ω	15000MHz
LQG15WZ0N7S02□	LQG15WH0N7S02□	0.7nH ±0.3nH	100MHz	-	250MHz	1200mA	0.03Ω	15000MHz
LQG15WZ0N8B02□	LQG15WH0N8B02□	0.8nH ±0.1nH	100MHz	-	250MHz	1200mA	0.03Ω	15000MHz
LQG15WZ0N8C02□	LQG15WH0N8C02□	0.8nH ±0.2nH	100MHz	-	250MHz	1200mA	0.03Ω	15000MHz
LQG15WZ0N8S02□	LQG15WH0N8S02□	0.8nH ±0.3nH	100MHz	-	250MHz	1200mA	0.03Ω	15000MHz
LQG15WZ0N9B02□	LQG15WH0N9B02□	0.9nH ±0.1nH	100MHz	-	250MHz	1200mA	0.03Ω	15000MHz
LQG15WZ0N9C02□	LQG15WH0N9C02□	0.9nH ±0.2nH	100MHz	-	250MHz	1200mA	0.03Ω	15000MHz
LQG15WZ0N9S02□	LQG15WH0N9S02□	0.9nH ±0.3nH	100MHz	-	250MHz	1200mA	0.03Ω	15000MHz
LQG15WZ1N0B02□	LQG15WH1N0B02□	1.0nH ±0.1nH	100MHz	-	250MHz	1200mA	0.03Ω	15000MHz
LQG15WZ1N0C02□	LQG15WH1N0C02□	1.0nH ±0.2nH	100MHz	-	250MHz	1200mA	0.03Ω	15000MHz
LQG15WZ1N0S02□	LQG15WH1N0S02□	1.0nH ±0.3nH	100MHz	-	250MHz	1200mA	0.03Ω	15000MHz
LQG15WZ1N1B02□	LQG15WH1N1B02□	1.1nH ±0.1nH	100MHz	-	250MHz	1200mA	0.03Ω	14000MHz
LQG15WZ1N1C02□	LQG15WH1N1C02□	1.1nH ±0.2nH	100MHz	-	250MHz	1200mA	0.03Ω	14000MHz
LQG15WZ1N1S02□	LQG15WH1N1S02□	1.1nH ±0.3nH	100MHz	-	250MHz	1200mA	0.03Ω	14000MHz
LQG15WZ1N2B02□	LQG15WH1N2B02□	1.2nH ±0.1nH	100MHz	-	250MHz	1200mA	0.03Ω	13000MHz
LQG15WZ1N2C02□	LQG15WH1N2C02□	1.2nH ±0.2nH	100MHz	-	250MHz	1200mA	0.03Ω	13000MHz
LQG15WZ1N2S02□	LQG15WH1N2S02□	1.2nH ±0.3nH	100MHz	-	250MHz	1200mA	0.03Ω	13000MHz
LQG15WZ1N3B02□	LQG15WH1N3B02□	1.3nH ±0.1nH	100MHz	-	250MHz	1200mA	0.03Ω	12000MHz
LQG15WZ1N3C02□	LQG15WH1N3C02□	1.3nH ±0.2nH	100MHz	-	250MHz	1200mA	0.03Ω	12000MHz
LQG15WZ1N3S02□	LQG15WH1N3S02□	1.3nH ±0.3nH	100MHz	-	250MHz	1200mA	0.03Ω	12000MHz
LQG15WZ1N4B02□	LQG15WH1N4B02□	1.4nH ±0.1nH	100MHz	23	250MHz	1000mA	0.04Ω	12000MHz
LQG15WZ1N4C02□	LQG15WH1N4C02□	1.4nH ±0.2nH	100MHz	23	250MHz	1000mA	0.04Ω	12000MHz
LQG15WZ1N4S02□	LQG15WH1N4S02□	1.4nH ±0.3nH	100MHz	23	250MHz	1000mA	0.04Ω	12000MHz
LQG15WZ1N5B02□	LQG15WH1N5B02□	1.5nH ±0.1nH	100MHz	23	250MHz	1000mA	0.04Ω	11000MHz
LQG15WZ1N5C02□	LQG15WH1N5C02□	1.5nH ±0.2nH	100MHz	23	250MHz	1000mA	0.04Ω	11000MHz
LQG15WZ1N5S02□	LQG15WH1N5S02□	1.5nH ±0.3nH	100MHz	23	250MHz	1000mA	0.04Ω	11000MHz
LQG15WZ1N6B02□	LQG15WH1N6B02□	1.6nH ±0.1nH	100MHz	23	250MHz	1000mA	0.04Ω	10000MHz
LQG15WZ1N6C02□	LQG15WH1N6C02□	1.6nH ±0.2nH	100MHz	23	250MHz	1000mA	0.04Ω	10000MHz
LQG15WZ1N6S02□	LQG15WH1N6S02□	1.6nH ±0.3nH	100MHz	23	250MHz	1000mA	0.04Ω	10000MHz
LQG15WZ1N7B02□	LQG15WH1N7B02□	1.7nH ±0.1nH	100MHz	23	250MHz	1000mA	0.04Ω	10000MHz
LQG15WZ1N7C02□	LQG15WH1N7C02□	1.7nH ±0.2nH	100MHz	23	250MHz	1000mA	0.04Ω	10000MHz

Operating temp.range (Self-temp.rise not included): -55 to 125°C

Only for reflow soldering

\*S.R.F: Self Resonant Frequency

Continued on the following page. ↗

Continued from the preceding page. ↘

Part Number		Inductance	Inductance Test Frequency	Q (min.)	Q Test Frequency	Rated Current	Max. of DC Resistance	S.R.F* (min.)
Infotainment	Powertrain/Safety							
LQG15WZ1N7S02□	LQG15WH1N7S02□	1.7nH ±0.3nH	100MHz	23	250MHz	1000mA	0.04Ω	10000MHz
LQG15WZ1N8B02□	LQG15WH1N8B02□	1.8nH ±0.1nH	100MHz	23	250MHz	1000mA	0.04Ω	9000MHz
LQG15WZ1N8C02□	LQG15WH1N8C02□	1.8nH ±0.2nH	100MHz	23	250MHz	1000mA	0.04Ω	9000MHz
LQG15WZ1N8S02□	LQG15WH1N8S02□	1.8nH ±0.3nH	100MHz	23	250MHz	1000mA	0.04Ω	9000MHz
LQG15WZ1N9B02□	LQG15WH1N9B02□	1.9nH ±0.1nH	100MHz	23	250MHz	1000mA	0.05Ω	8000MHz
LQG15WZ1N9C02□	LQG15WH1N9C02□	1.9nH ±0.2nH	100MHz	23	250MHz	1000mA	0.05Ω	8000MHz
LQG15WZ1N9S02□	LQG15WH1N9S02□	1.9nH ±0.3nH	100MHz	23	250MHz	1000mA	0.05Ω	8000MHz
LQG15WZ2N0B02□	LQG15WH2N0B02□	2.0nH ±0.1nH	100MHz	23	250MHz	1000mA	0.05Ω	8000MHz
LQG15WZ2N0C02□	LQG15WH2N0C02□	2.0nH ±0.2nH	100MHz	23	250MHz	1000mA	0.05Ω	8000MHz
LQG15WZ2N0S02□	LQG15WH2N0S02□	2.0nH ±0.3nH	100MHz	23	250MHz	1000mA	0.05Ω	8000MHz
LQG15WZ2N1B02□	LQG15WH2N1B02□	2.1nH ±0.1nH	100MHz	23	250MHz	1000mA	0.06Ω	8000MHz
LQG15WZ2N1C02□	LQG15WH2N1C02□	2.1nH ±0.2nH	100MHz	23	250MHz	1000mA	0.06Ω	8000MHz
LQG15WZ2N1S02□	LQG15WH2N1S02□	2.1nH ±0.3nH	100MHz	23	250MHz	1000mA	0.06Ω	8000MHz
LQG15WZ2N2B02□	LQG15WH2N2B02□	2.2nH ±0.1nH	100MHz	23	250MHz	1000mA	0.06Ω	8000MHz
LQG15WZ2N2C02□	LQG15WH2N2C02□	2.2nH ±0.2nH	100MHz	23	250MHz	1000mA	0.06Ω	8000MHz
LQG15WZ2N2S02□	LQG15WH2N2S02□	2.2nH ±0.3nH	100MHz	23	250MHz	1000mA	0.06Ω	8000MHz
LQG15WZ2N3B02□	LQG15WH2N3B02□	2.3nH ±0.1nH	100MHz	23	250MHz	1000mA	0.07Ω	7000MHz
LQG15WZ2N3C02□	LQG15WH2N3C02□	2.3nH ±0.2nH	100MHz	23	250MHz	1000mA	0.07Ω	7000MHz
LQG15WZ2N3S02□	LQG15WH2N3S02□	2.3nH ±0.3nH	100MHz	23	250MHz	1000mA	0.07Ω	7000MHz
LQG15WZ2N4B02□	LQG15WH2N4B02□	2.4nH ±0.1nH	100MHz	23	250MHz	1000mA	0.06Ω	6500MHz
LQG15WZ2N4C02□	LQG15WH2N4C02□	2.4nH ±0.2nH	100MHz	23	250MHz	1000mA	0.06Ω	6500MHz
LQG15WZ2N4S02□	LQG15WH2N4S02□	2.4nH ±0.3nH	100MHz	23	250MHz	1000mA	0.06Ω	6500MHz
LQG15WZ2N5B02□	LQG15WH2N5B02□	2.5nH ±0.1nH	100MHz	23	250MHz	900mA	0.07Ω	6500MHz
LQG15WZ2N5C02□	LQG15WH2N5C02□	2.5nH ±0.2nH	100MHz	23	250MHz	900mA	0.07Ω	6500MHz
LQG15WZ2N5S02□	LQG15WH2N5S02□	2.5nH ±0.3nH	100MHz	23	250MHz	900mA	0.07Ω	6500MHz
LQG15WZ2N6B02□	LQG15WH2N6B02□	2.6nH ±0.1nH	100MHz	23	250MHz	900mA	0.07Ω	6500MHz
LQG15WZ2N6C02□	LQG15WH2N6C02□	2.6nH ±0.2nH	100MHz	23	250MHz	900mA	0.07Ω	6500MHz
LQG15WZ2N6S02□	LQG15WH2N6S02□	2.6nH ±0.3nH	100MHz	23	250MHz	900mA	0.07Ω	6500MHz
LQG15WZ2N7B02□	LQG15WH2N7B02□	2.7nH ±0.1nH	100MHz	23	250MHz	900mA	0.07Ω	6500MHz
LQG15WZ2N7C02□	LQG15WH2N7C02□	2.7nH ±0.2nH	100MHz	23	250MHz	900mA	0.07Ω	6500MHz
LQG15WZ2N7S02□	LQG15WH2N7S02□	2.7nH ±0.3nH	100MHz	23	250MHz	900mA	0.07Ω	6500MHz
LQG15WZ2N8B02□	LQG15WH2N8B02□	2.8nH ±0.1nH	100MHz	23	250MHz	900mA	0.08Ω	6500MHz
LQG15WZ2N8C02□	LQG15WH2N8C02□	2.8nH ±0.2nH	100MHz	23	250MHz	900mA	0.08Ω	6500MHz
LQG15WZ2N8S02□	LQG15WH2N8S02□	2.8nH ±0.3nH	100MHz	23	250MHz	900mA	0.08Ω	6500MHz
LQG15WZ2N9B02□	LQG15WH2N9B02□	2.9nH ±0.1nH	100MHz	23	250MHz	900mA	0.08Ω	6500MHz
LQG15WZ2N9C02□	LQG15WH2N9C02□	2.9nH ±0.2nH	100MHz	23	250MHz	900mA	0.08Ω	6500MHz
LQG15WZ2N9S02□	LQG15WH2N9S02□	2.9nH ±0.3nH	100MHz	23	250MHz	900mA	0.08Ω	6500MHz
LQG15WZ3N0B02□	LQG15WH3N0B02□	3.0nH ±0.1nH	100MHz	23	250MHz	900mA	0.08Ω	6000MHz
LQG15WZ3N0C02□	LQG15WH3N0C02□	3.0nH ±0.2nH	100MHz	23	250MHz	900mA	0.08Ω	6000MHz
LQG15WZ3N0S02□	LQG15WH3N0S02□	3.0nH ±0.3nH	100MHz	23	250MHz	900mA	0.08Ω	6000MHz
LQG15WZ3N1B02□	LQG15WH3N1B02□	3.1nH ±0.1nH	100MHz	23	250MHz	900mA	0.09Ω	6000MHz
LQG15WZ3N1C02□	LQG15WH3N1C02□	3.1nH ±0.2nH	100MHz	23	250MHz	900mA	0.09Ω	6000MHz
LQG15WZ3N1S02□	LQG15WH3N1S02□	3.1nH ±0.3nH	100MHz	23	250MHz	900mA	0.09Ω	6000MHz
LQG15WZ3N2B02□	LQG15WH3N2B02□	3.2nH ±0.1nH	100MHz	23	250MHz	900mA	0.09Ω	6000MHz
LQG15WZ3N2C02□	LQG15WH3N2C02□	3.2nH ±0.2nH	100MHz	23	250MHz	900mA	0.09Ω	6000MHz
LQG15WZ3N2S02□	LQG15WH3N2S02□	3.2nH ±0.3nH	100MHz	23	250MHz	900mA	0.09Ω	6000MHz
LQG15WZ3N3B02□	LQG15WH3N3B02□	3.3nH ±0.1nH	100MHz	23	250MHz	900mA	0.08Ω	6000MHz
LQG15WZ3N3C02□	LQG15WH3N3C02□	3.3nH ±0.2nH	100MHz	23	250MHz	900mA	0.08Ω	6000MHz
LQG15WZ3N3S02□	LQG15WH3N3S02□	3.3nH ±0.3nH	100MHz	23	250MHz	900mA	0.08Ω	6000MHz
LQG15WZ3N4B02□	LQG15WH3N4B02□	3.4nH ±0.1nH	100MHz	23	250MHz	900mA	0.09Ω	6000MHz
LQG15WZ3N4C02□	LQG15WH3N4C02□	3.4nH ±0.2nH	100MHz	23	250MHz	900mA	0.09Ω	6000MHz
LQG15WZ3N4S02□	LQG15WH3N4S02□	3.4nH ±0.3nH	100MHz	23	250MHz	900mA	0.09Ω	6000MHz
LQG15WZ3N5B02□	LQG15WH3N5B02□	3.5nH ±0.1nH	100MHz	23	250MHz	900mA	0.09Ω	5800MHz

Operating temp.range (Self-temp.rise not included): -55 to 125°C  
 Only for reflow soldering  
 \*S.R.F: Self Resonant Frequency

Continued on the following page. ↗



Continued from the preceding page. ↘

Part Number		Inductance	Inductance Test Frequency	Q (min.)	Q Test Frequency	Rated Current	Max. of DC Resistance	S.R.F* (min.)
Infotainment	Powertrain/Safety							
LQG15WZ3N5C02□	LQG15WH3N5C02□	3.5nH ±0.2nH	100MHz	23	250MHz	900mA	0.09Ω	5800MHz
LQG15WZ3N5S02□	LQG15WH3N5S02□	3.5nH ±0.3nH	100MHz	23	250MHz	900mA	0.09Ω	5800MHz
LQG15WZ3N6B02□	LQG15WH3N6B02□	3.6nH ±0.1nH	100MHz	23	250MHz	900mA	0.09Ω	5500MHz
LQG15WZ3N6C02□	LQG15WH3N6C02□	3.6nH ±0.2nH	100MHz	23	250MHz	900mA	0.09Ω	5500MHz
LQG15WZ3N6S02□	LQG15WH3N6S02□	3.6nH ±0.3nH	100MHz	23	250MHz	900mA	0.09Ω	5500MHz
LQG15WZ3N7B02□	LQG15WH3N7B02□	3.7nH ±0.1nH	100MHz	23	250MHz	900mA	0.10Ω	5500MHz
LQG15WZ3N7C02□	LQG15WH3N7C02□	3.7nH ±0.2nH	100MHz	23	250MHz	900mA	0.10Ω	5500MHz
LQG15WZ3N7S02□	LQG15WH3N7S02□	3.7nH ±0.3nH	100MHz	23	250MHz	900mA	0.10Ω	5500MHz
LQG15WZ3N8B02□	LQG15WH3N8B02□	3.8nH ±0.1nH	100MHz	23	250MHz	900mA	0.10Ω	5000MHz
LQG15WZ3N8C02□	LQG15WH3N8C02□	3.8nH ±0.2nH	100MHz	23	250MHz	900mA	0.10Ω	5000MHz
LQG15WZ3N8S02□	LQG15WH3N8S02□	3.8nH ±0.3nH	100MHz	23	250MHz	900mA	0.10Ω	5000MHz
LQG15WZ3N9B02□	LQG15WH3N9B02□	3.9nH ±0.1nH	100MHz	23	250MHz	900mA	0.09Ω	5000MHz
LQG15WZ3N9C02□	LQG15WH3N9C02□	3.9nH ±0.2nH	100MHz	23	250MHz	900mA	0.09Ω	5000MHz
LQG15WZ3N9S02□	LQG15WH3N9S02□	3.9nH ±0.3nH	100MHz	23	250MHz	900mA	0.09Ω	5000MHz
LQG15WZ4N1B02□	LQG15WH4N1B02□	4.1nH ±0.1nH	100MHz	23	250MHz	800mA	0.10Ω	5000MHz
LQG15WZ4N1C02□	LQG15WH4N1C02□	4.1nH ±0.2nH	100MHz	23	250MHz	800mA	0.10Ω	5000MHz
LQG15WZ4N1S02□	LQG15WH4N1S02□	4.1nH ±0.3nH	100MHz	23	250MHz	800mA	0.10Ω	5000MHz
LQG15WZ4N3B02□	LQG15WH4N3B02□	4.3nH ±0.1nH	100MHz	23	250MHz	800mA	0.10Ω	5000MHz
LQG15WZ4N3C02□	LQG15WH4N3C02□	4.3nH ±0.2nH	100MHz	23	250MHz	800mA	0.10Ω	5000MHz
LQG15WZ4N3S02□	LQG15WH4N3S02□	4.3nH ±0.3nH	100MHz	23	250MHz	800mA	0.10Ω	5000MHz
LQG15WZ4N7B02□	LQG15WH4N7B02□	4.7nH ±0.1nH	100MHz	23	250MHz	800mA	0.11Ω	5000MHz
LQG15WZ4N7C02□	LQG15WH4N7C02□	4.7nH ±0.2nH	100MHz	23	250MHz	800mA	0.11Ω	5000MHz
LQG15WZ4N7S02□	LQG15WH4N7S02□	4.7nH ±0.3nH	100MHz	23	250MHz	800mA	0.11Ω	5000MHz
LQG15WZ5N1B02□	LQG15WH5N1B02□	5.1nH ±0.1nH	100MHz	23	250MHz	800mA	0.12Ω	4500MHz
LQG15WZ5N1C02□	LQG15WH5N1C02□	5.1nH ±0.2nH	100MHz	23	250MHz	800mA	0.12Ω	4500MHz
LQG15WZ5N1S02□	LQG15WH5N1S02□	5.1nH ±0.3nH	100MHz	23	250MHz	800mA	0.12Ω	4500MHz
LQG15WZ5N6B02□	LQG15WH5N6B02□	5.6nH ±0.1nH	100MHz	23	250MHz	800mA	0.13Ω	4500MHz
LQG15WZ5N6C02□	LQG15WH5N6C02□	5.6nH ±0.2nH	100MHz	23	250MHz	800mA	0.13Ω	4500MHz
LQG15WZ5N6S02□	LQG15WH5N6S02□	5.6nH ±0.3nH	100MHz	23	250MHz	800mA	0.13Ω	4500MHz
LQG15WZ5N8B02□	LQG15WH5N8B02□	5.8nH ±0.1nH	100MHz	23	250MHz	700mA	0.13Ω	4000MHz
LQG15WZ5N8C02□	LQG15WH5N8C02□	5.8nH ±0.2nH	100MHz	23	250MHz	700mA	0.13Ω	4000MHz
LQG15WZ5N8S02□	LQG15WH5N8S02□	5.8nH ±0.3nH	100MHz	23	250MHz	700mA	0.13Ω	4000MHz
LQG15WZ6N2B02□	LQG15WH6N2B02□	6.2nH ±0.1nH	100MHz	23	250MHz	700mA	0.13Ω	4000MHz
LQG15WZ6N2C02□	LQG15WH6N2C02□	6.2nH ±0.2nH	100MHz	23	250MHz	700mA	0.13Ω	4000MHz
LQG15WZ6N2S02□	LQG15WH6N2S02□	6.2nH ±0.3nH	100MHz	23	250MHz	700mA	0.13Ω	4000MHz
LQG15WZ6N8G02□	LQG15WH6N8G02□	6.8nH ±2%	100MHz	23	250MHz	700mA	0.14Ω	4000MHz
LQG15WZ6N8H02□	LQG15WH6N8H02□	6.8nH ±3%	100MHz	23	250MHz	700mA	0.14Ω	4000MHz
LQG15WZ6N8J02□	LQG15WH6N8J02□	6.8nH ±5%	100MHz	23	250MHz	700mA	0.14Ω	4000MHz
LQG15WZ7N3G02□	LQG15WH7N3G02□	7.3nH ±2%	100MHz	23	250MHz	600mA	0.17Ω	4000MHz
LQG15WZ7N3H02□	LQG15WH7N3H02□	7.3nH ±3%	100MHz	23	250MHz	600mA	0.17Ω	4000MHz
LQG15WZ7N3J02□	LQG15WH7N3J02□	7.3nH ±5%	100MHz	23	250MHz	600mA	0.17Ω	4000MHz
LQG15WZ7N5G02□	LQG15WH7N5G02□	7.5nH ±2%	100MHz	23	250MHz	600mA	0.16Ω	4000MHz
LQG15WZ7N5H02□	LQG15WH7N5H02□	7.5nH ±3%	100MHz	23	250MHz	600mA	0.16Ω	4000MHz
LQG15WZ7N5J02□	LQG15WH7N5J02□	7.5nH ±5%	100MHz	23	250MHz	600mA	0.16Ω	4000MHz
LQG15WZ8N2G02□	LQG15WH8N2G02□	8.2nH ±2%	100MHz	23	250MHz	550mA	0.16Ω	3600MHz
LQG15WZ8N2H02□	LQG15WH8N2H02□	8.2nH ±3%	100MHz	23	250MHz	550mA	0.16Ω	3600MHz
LQG15WZ8N2J02□	LQG15WH8N2J02□	8.2nH ±5%	100MHz	23	250MHz	550mA	0.16Ω	3600MHz
LQG15WZ8N7G02□	LQG15WH8N7G02□	8.7nH ±2%	100MHz	23	250MHz	550mA	0.17Ω	3500MHz
LQG15WZ8N7H02□	LQG15WH8N7H02□	8.7nH ±3%	100MHz	23	250MHz	550mA	0.17Ω	3500MHz
LQG15WZ8N7J02□	LQG15WH8N7J02□	8.7nH ±5%	100MHz	23	250MHz	550mA	0.17Ω	3500MHz
LQG15WZ9N1G02□	LQG15WH9N1G02□	9.1nH ±2%	100MHz	23	250MHz	550mA	0.17Ω	3400MHz
LQG15WZ9N1H02□	LQG15WH9N1H02□	9.1nH ±3%	100MHz	23	250MHz	550mA	0.17Ω	3400MHz
LQG15WZ9N1J02□	LQG15WH9N1J02□	9.1nH ±5%	100MHz	23	250MHz	550mA	0.17Ω	3400MHz

Operating temp.range (Self-temp.rise not included): -55 to 125°C

Only for reflow soldering

\*S.R.F: Self Resonant Frequency

Continued on the following page. ↗

Inductors for Power Lines

Inductors for General Circuits

RF Inductors

Continued from the preceding page. ↘

Part Number		Inductance	Inductance Test Frequency	Q (min.)	Q Test Frequency	Rated Current	Max. of DC Resistance	S.R.F* (min.)
Infotainment	Powertrain/Safety							
LQG15WZ9N5G02□	LQG15WH9N5G02□	9.5nH ±2%	100MHz	23	250MHz	500mA	0.21Ω	3300MHz
LQG15WZ9N5H02□	LQG15WH9N5H02□	9.5nH ±3%	100MHz	23	250MHz	500mA	0.21Ω	3300MHz
LQG15WZ9N5J02□	LQG15WH9N5J02□	9.5nH ±5%	100MHz	23	250MHz	500mA	0.21Ω	3300MHz
LQG15WZ10NG02□	LQG15WH10NG02□	10nH ±2%	100MHz	23	250MHz	500mA	0.19Ω	3300MHz
LQG15WZ10NH02□	LQG15WH10NH02□	10nH ±3%	100MHz	23	250MHz	500mA	0.19Ω	3300MHz
LQG15WZ10NJ02□	LQG15WH10NJ02□	10nH ±5%	100MHz	23	250MHz	500mA	0.19Ω	3300MHz
LQG15WZ11NG02□	LQG15WH11NG02□	11nH ±2%	100MHz	23	250MHz	450mA	0.22Ω	3000MHz
LQG15WZ11NH02□	LQG15WH11NH02□	11nH ±3%	100MHz	23	250MHz	450mA	0.22Ω	3000MHz
LQG15WZ11NJ02□	LQG15WH11NJ02□	11nH ±5%	100MHz	23	250MHz	450mA	0.22Ω	3000MHz
LQG15WZ12NG02□	LQG15WH12NG02□	12nH ±2%	100MHz	23	250MHz	450mA	0.24Ω	2800MHz
LQG15WZ12NH02□	LQG15WH12NH02□	12nH ±3%	100MHz	23	250MHz	450mA	0.24Ω	2800MHz
LQG15WZ12NJ02□	LQG15WH12NJ02□	12nH ±5%	100MHz	23	250MHz	450mA	0.24Ω	2800MHz
LQG15WZ13NG02□	LQG15WH13NG02□	13nH ±2%	100MHz	23	250MHz	400mA	0.26Ω	2800MHz
LQG15WZ13NH02□	LQG15WH13NH02□	13nH ±3%	100MHz	23	250MHz	400mA	0.26Ω	2800MHz
LQG15WZ13NJ02□	LQG15WH13NJ02□	13nH ±5%	100MHz	23	250MHz	400mA	0.26Ω	2800MHz
LQG15WZ15NG02□	LQG15WH15NG02□	15nH ±2%	100MHz	23	250MHz	400mA	0.28Ω	2300MHz
LQG15WZ15NH02□	LQG15WH15NH02□	15nH ±3%	100MHz	23	250MHz	400mA	0.28Ω	2300MHz
LQG15WZ15NJ02□	LQG15WH15NJ02□	15nH ±5%	100MHz	23	250MHz	400mA	0.28Ω	2300MHz
LQG15WZ16NG02□	LQG15WH16NG02□	16nH ±2%	100MHz	20	250MHz	260mA	0.8Ω	2300MHz
LQG15WZ16NH02□	LQG15WH16NH02□	16nH ±3%	100MHz	20	250MHz	260mA	0.8Ω	2300MHz
LQG15WZ16NJ02□	LQG15WH16NJ02□	16nH ±5%	100MHz	20	250MHz	260mA	0.8Ω	2300MHz
LQG15WZ18NG02□	LQG15WH18NG02□	18nH ±2%	100MHz	22	250MHz	260mA	0.8Ω	2300MHz
LQG15WZ18NH02□	LQG15WH18NH02□	18nH ±3%	100MHz	22	250MHz	260mA	0.8Ω	2300MHz
LQG15WZ18NJ02□	LQG15WH18NJ02□	18nH ±5%	100MHz	22	250MHz	260mA	0.8Ω	2300MHz
LQG15WZ19NG02□	LQG15WH19NG02□	19nH ±2%	100MHz	20	250MHz	260mA	0.8Ω	2300MHz
LQG15WZ19NH02□	LQG15WH19NH02□	19nH ±3%	100MHz	20	250MHz	260mA	0.8Ω	2300MHz
LQG15WZ19NJ02□	LQG15WH19NJ02□	19nH ±5%	100MHz	20	250MHz	260mA	0.8Ω	2300MHz
LQG15WZ20NG02□	LQG15WH20NG02□	20nH ±2%	100MHz	20	250MHz	260mA	1.1Ω	2100MHz
LQG15WZ20NH02□	LQG15WH20NH02□	20nH ±3%	100MHz	20	250MHz	260mA	1.1Ω	2100MHz
LQG15WZ20NJ02□	LQG15WH20NJ02□	20nH ±5%	100MHz	20	250MHz	260mA	1.1Ω	2100MHz
LQG15WZ22NG02□	LQG15WH22NG02□	22nH ±2%	100MHz	20	250MHz	230mA	1.1Ω	2100MHz
LQG15WZ22NH02□	LQG15WH22NH02□	22nH ±3%	100MHz	20	250MHz	230mA	1.1Ω	2100MHz
LQG15WZ22NJ02□	LQG15WH22NJ02□	22nH ±5%	100MHz	20	250MHz	230mA	1.1Ω	2100MHz
LQG15WZ23NG02□	LQG15WH23NG02□	23nH ±2%	100MHz	22	250MHz	230mA	1.1Ω	2000MHz
LQG15WZ23NH02□	LQG15WH23NH02□	23nH ±3%	100MHz	22	250MHz	230mA	1.1Ω	2000MHz
LQG15WZ23NJ02□	LQG15WH23NJ02□	23nH ±5%	100MHz	22	250MHz	230mA	1.1Ω	2000MHz
LQG15WZ24NG02□	LQG15WH24NG02□	24nH ±2%	100MHz	20	250MHz	230mA	1.2Ω	2000MHz
LQG15WZ24NH02□	LQG15WH24NH02□	24nH ±3%	100MHz	20	250MHz	230mA	1.2Ω	2000MHz
LQG15WZ24NJ02□	LQG15WH24NJ02□	24nH ±5%	100MHz	20	250MHz	230mA	1.2Ω	2000MHz
LQG15WZ27NG02□	LQG15WH27NG02□	27nH ±2%	100MHz	20	250MHz	230mA	1.3Ω	1700MHz
LQG15WZ27NH02□	LQG15WH27NH02□	27nH ±3%	100MHz	20	250MHz	230mA	1.3Ω	1700MHz
LQG15WZ27NJ02□	LQG15WH27NJ02□	27nH ±5%	100MHz	20	250MHz	230mA	1.3Ω	1700MHz
LQG15WZ30NG02□	LQG15WH30NG02□	30nH ±2%	100MHz	20	250MHz	220mA	1.3Ω	1700MHz
LQG15WZ30NH02□	LQG15WH30NH02□	30nH ±3%	100MHz	20	250MHz	220mA	1.3Ω	1700MHz
LQG15WZ30NJ02□	LQG15WH30NJ02□	30nH ±5%	100MHz	20	250MHz	220mA	1.3Ω	1700MHz
LQG15WZ33NG02□	LQG15WH33NG02□	33nH ±2%	100MHz	20	250MHz	220mA	1.5Ω	1600MHz
LQG15WZ33NH02□	LQG15WH33NH02□	33nH ±3%	100MHz	20	250MHz	220mA	1.5Ω	1600MHz
LQG15WZ33NJ02□	LQG15WH33NJ02□	33nH ±5%	100MHz	20	250MHz	220mA	1.5Ω	1600MHz
LQG15WZ36NG02□	LQG15WH36NG02□	36nH ±2%	100MHz	20	250MHz	190mA	1.5Ω	1600MHz
LQG15WZ36NH02□	LQG15WH36NH02□	36nH ±3%	100MHz	20	250MHz	190mA	1.5Ω	1600MHz
LQG15WZ36NJ02□	LQG15WH36NJ02□	36nH ±5%	100MHz	20	250MHz	190mA	1.5Ω	1600MHz
LQG15WZ39NG02□	LQG15WH39NG02□	39nH ±2%	100MHz	20	250MHz	190mA	1.5Ω	1400MHz
LQG15WZ39NH02□	LQG15WH39NH02□	39nH ±3%	100MHz	20	250MHz	190mA	1.5Ω	1400MHz

Operating temp.range (Self-temp.rise not included): -55 to 125°C  
 Only for reflow soldering  
 \*S.R.F: Self Resonant Frequency

Continued on the following page. ↗

Inductors for Power Lines

Inductors for General Circuits

RF Inductors

Continued from the preceding page. ↘

Part Number		Inductance	Inductance Test Frequency	Q (min.)	Q Test Frequency	Rated Current	Max. of DC Resistance	S.R.F* (min.)
Infotainment	Powertrain/Safety							
LQG15WZ39NJ02□	LQG15WH39NJ02□	39nH ±5%	100MHz	20	250MHz	190mA	1.5Ω	1400MHz
LQG15WZ40NG02□	LQG15WH40NG02□	40nH ±2%	100MHz	20	250MHz	190mA	1.5Ω	1400MHz
LQG15WZ40NH02□	LQG15WH40NH02□	40nH ±3%	100MHz	20	250MHz	190mA	1.5Ω	1400MHz
LQG15WZ40NJ02□	LQG15WH40NJ02□	40nH ±5%	100MHz	20	250MHz	190mA	1.5Ω	1400MHz
LQG15WZ43NG02□	LQG15WH43NG02□	43nH ±2%	100MHz	22	250MHz	190mA	1.6Ω	1400MHz
LQG15WZ43NH02□	LQG15WH43NH02□	43nH ±3%	100MHz	22	250MHz	190mA	1.6Ω	1400MHz
LQG15WZ43NJ02□	LQG15WH43NJ02□	43nH ±5%	100MHz	22	250MHz	190mA	1.6Ω	1400MHz
LQG15WZ47NG02□	LQG15WH47NG02□	47nH ±2%	100MHz	22	250MHz	190mA	1.6Ω	1300MHz
LQG15WZ47NH02□	LQG15WH47NH02□	47nH ±3%	100MHz	22	250MHz	190mA	1.6Ω	1300MHz
LQG15WZ47NJ02□	LQG15WH47NJ02□	47nH ±5%	100MHz	22	250MHz	190mA	1.6Ω	1300MHz
LQG15WZ51NG02□	LQG15WH51NG02□	51nH ±2%	100MHz	22	250MHz	190mA	1.8Ω	1300MHz
LQG15WZ51NH02□	LQG15WH51NH02□	51nH ±3%	100MHz	22	250MHz	190mA	1.8Ω	1300MHz
LQG15WZ51NJ02□	LQG15WH51NJ02□	51nH ±5%	100MHz	22	250MHz	190mA	1.8Ω	1300MHz
LQG15WZ56NG02□	LQG15WH56NG02□	56nH ±2%	100MHz	22	250MHz	180mA	1.8Ω	1200MHz
LQG15WZ56NH02□	LQG15WH56NH02□	56nH ±3%	100MHz	22	250MHz	180mA	1.8Ω	1200MHz
LQG15WZ56NJ02□	LQG15WH56NJ02□	56nH ±5%	100MHz	22	250MHz	180mA	1.8Ω	1200MHz
LQG15WZ62NG02□	LQG15WH62NG02□	62nH ±2%	100MHz	22	250MHz	180mA	1.9Ω	1100MHz
LQG15WZ62NH02□	LQG15WH62NH02□	62nH ±3%	100MHz	22	250MHz	180mA	1.9Ω	1100MHz
LQG15WZ62NJ02□	LQG15WH62NJ02□	62nH ±5%	100MHz	22	250MHz	180mA	1.9Ω	1100MHz
LQG15WZ68NG02□	LQG15WH68NG02□	68nH ±2%	100MHz	22	250MHz	160mA	2.0Ω	1100MHz
LQG15WZ68NH02□	LQG15WH68NH02□	68nH ±3%	100MHz	22	250MHz	160mA	2.0Ω	1100MHz
LQG15WZ68NJ02□	LQG15WH68NJ02□	68nH ±5%	100MHz	22	250MHz	160mA	2.0Ω	1100MHz
LQG15WZ72NG02□	LQG15WH72NG02□	72nH ±2%	100MHz	22	250MHz	160mA	2.2Ω	1100MHz
LQG15WZ72NH02□	LQG15WH72NH02□	72nH ±3%	100MHz	22	250MHz	160mA	2.2Ω	1100MHz
LQG15WZ72NJ02□	LQG15WH72NJ02□	72nH ±5%	100MHz	22	250MHz	160mA	2.2Ω	1100MHz
LQG15WZ75NG02□	LQG15WH75NG02□	75nH ±2%	100MHz	22	250MHz	160mA	2.2Ω	1100MHz
LQG15WZ75NH02□	LQG15WH75NH02□	75nH ±3%	100MHz	22	250MHz	160mA	2.2Ω	1100MHz
LQG15WZ75NJ02□	LQG15WH75NJ02□	75nH ±5%	100MHz	22	250MHz	160mA	2.2Ω	1100MHz
LQG15WZ82NG02□	LQG15WH82NG02□	82nH ±2%	100MHz	22	250MHz	160mA	2.3Ω	900MHz
LQG15WZ82NH02□	LQG15WH82NH02□	82nH ±3%	100MHz	22	250MHz	160mA	2.3Ω	900MHz
LQG15WZ82NJ02□	LQG15WH82NJ02□	82nH ±5%	100MHz	22	250MHz	160mA	2.3Ω	900MHz
LQG15WZ91NG02□	LQG15WH91NG02□	91nH ±2%	100MHz	23	250MHz	160mA	2.3Ω	900MHz
LQG15WZ91NH02□	LQG15WH91NH02□	91nH ±3%	100MHz	23	250MHz	160mA	2.3Ω	900MHz
LQG15WZ91NJ02□	LQG15WH91NJ02□	91nH ±5%	100MHz	23	250MHz	160mA	2.3Ω	900MHz
LQG15WZR10G02□	LQG15WHR10G02□	100nH ±2%	100MHz	23	250MHz	150mA	2.5Ω	900MHz
LQG15WZR10H02□	LQG15WHR10H02□	100nH ±3%	100MHz	23	250MHz	150mA	2.5Ω	900MHz
LQG15WZR10J02□	LQG15WHR10J02□	100nH ±5%	100MHz	23	250MHz	150mA	2.5Ω	900MHz
LQG15WZR11G02□	LQG15WHR11G02□	110nH ±2%	100MHz	22	250MHz	150mA	2.7Ω	800MHz
LQG15WZR11H02□	LQG15WHR11H02□	110nH ±3%	100MHz	22	250MHz	150mA	2.7Ω	800MHz
LQG15WZR11J02□	LQG15WHR11J02□	110nH ±5%	100MHz	22	250MHz	150mA	2.7Ω	800MHz
LQG15WZR12G02□	LQG15WHR12G02□	120nH ±2%	100MHz	22	250MHz	140mA	2.7Ω	800MHz
LQG15WZR12H02□	LQG15WHR12H02□	120nH ±3%	100MHz	22	250MHz	140mA	2.7Ω	800MHz
LQG15WZR12J02□	LQG15WHR12J02□	120nH ±5%	100MHz	22	250MHz	140mA	2.7Ω	800MHz
LQG15WZR13G02□	LQG15WHR13G02□	130nH ±2%	100MHz	22	250MHz	110mA	2.9Ω	800MHz
LQG15WZR13H02□	LQG15WHR13H02□	130nH ±3%	100MHz	22	250MHz	110mA	2.9Ω	800MHz
LQG15WZR13J02□	LQG15WHR13J02□	130nH ±5%	100MHz	22	250MHz	110mA	2.9Ω	800MHz
LQG15WZR15G02□	LQG15WHR15G02□	150nH ±2%	100MHz	22	250MHz	110mA	3.0Ω	800MHz
LQG15WZR15H02□	LQG15WHR15H02□	150nH ±3%	100MHz	22	250MHz	110mA	3.0Ω	800MHz
LQG15WZR15J02□	LQG15WHR15J02□	150nH ±5%	100MHz	22	250MHz	110mA	3.0Ω	800MHz

Operating temp.range (Self-temp.rise not included): -55 to 125°C

Only for reflow soldering

\*S.R.F: Self Resonant Frequency

Continued on the following page. ↗

Inductors for Power Lines

Inductors for General Circuits

RF Inductors

Continued from the preceding page. ↘

**Inductance-Frequency Characteristics (Typ.)**

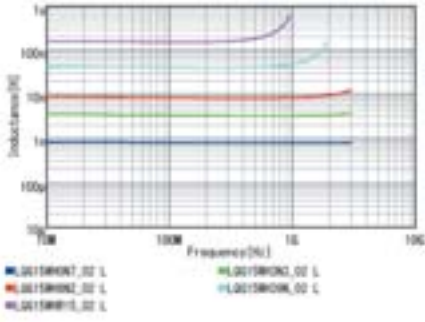

**Q-Frequency Characteristics (Typ.)**

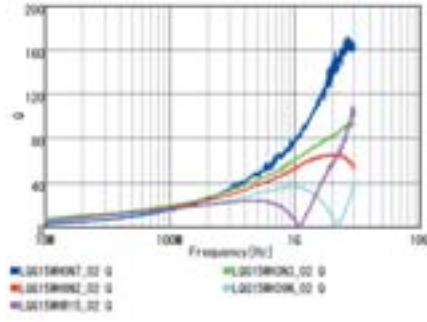

Inductors for Power Lines

Inductors for General Circuits

RF Inductors

**RF Inductors**

# LQG18HH\_00 Series 0603 (1608) inch (mm)

**Appearance/Dimensions**

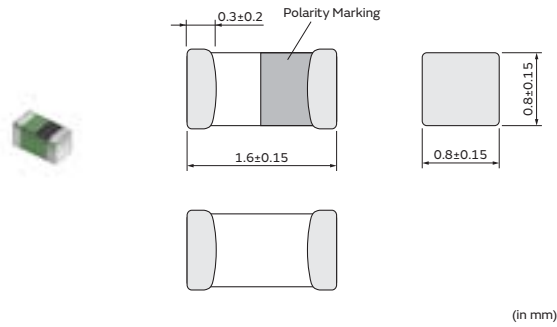

**Packaging**

Code	Packaging	Minimum Quantity
D	ø180mm Paper Taping	4000
J	ø330mm Paper Taping	10000
B	Packing in Bulk	1000

**Rated Value (□: packaging code)**

Part Number		Inductance	Inductance Test Frequency	Q (min.)	Q Test Frequency	Rated Current	Max. of DC Resistance	S.R.F* (min.)
Infotainment	Powertrain/Safety							
—	LQG18HH1N2S00□	1.2nH ±0.3nH	100MHz	12	100MHz	1100mA	0.10Ω	6000MHz
—	LQG18HH1N5S00□	1.5nH ±0.3nH	100MHz	12	100MHz	1100mA	0.10Ω	6000MHz
—	LQG18HH1N8S00□	1.8nH ±0.3nH	100MHz	12	100MHz	1100mA	0.10Ω	5000MHz
—	LQG18HH2N2S00□	2.2nH ±0.3nH	100MHz	12	100MHz	1100mA	0.10Ω	5000MHz
—	LQG18HH2N7S00□	2.7nH ±0.3nH	100MHz	12	100MHz	1000mA	0.13Ω	4000MHz
—	LQG18HH3N3S00□	3.3nH ±0.3nH	100MHz	12	100MHz	900mA	0.14Ω	4000MHz
—	LQG18HH3N9S00□	3.9nH ±0.3nH	100MHz	12	100MHz	900mA	0.15Ω	3000MHz
—	LQG18HH4N7S00□	4.7nH ±0.3nH	100MHz	12	100MHz	800mA	0.16Ω	3000MHz
—	LQG18HH5N6S00□	5.6nH ±0.3nH	100MHz	12	100MHz	800mA	0.17Ω	3000MHz
—	LQG18HH6N2S00□	6.2nH ±0.3nH	100MHz	12	100MHz	800mA	0.18Ω	2800MHz
—	LQG18HH6N8J00□	6.8nH ±5%	100MHz	12	100MHz	800mA	0.18Ω	2800MHz
—	LQG18HH8N2J00□	8.2nH ±5%	100MHz	12	100MHz	800mA	0.20Ω	2600MHz
—	LQG18HH10NJ00□	10nH ±5%	100MHz	12	100MHz	700mA	0.25Ω	2400MHz
—	LQG18HH12NJ00□	12nH ±5%	100MHz	12	100MHz	600mA	0.30Ω	2200MHz
—	LQG18HH15NJ00□	15nH ±5%	100MHz	12	100MHz	600mA	0.35Ω	1800MHz
—	LQG18HH18NJ00□	18nH ±5%	100MHz	12	100MHz	600mA	0.35Ω	1800MHz
—	LQG18HH22NJ00□	22nH ±5%	100MHz	12	100MHz	500mA	0.50Ω	1600MHz
—	LQG18HH27NJ00□	27nH ±5%	100MHz	12	100MHz	500mA	0.54Ω	1400MHz
—	LQG18HH33NJ00□	33nH ±5%	100MHz	12	100MHz	500mA	0.54Ω	1200MHz
—	LQG18HH39NJ00□	39nH ±5%	100MHz	12	100MHz	400mA	0.60Ω	1000MHz
—	LQG18HH47NJ00□	47nH ±5%	100MHz	12	100MHz	400mA	0.70Ω	900MHz
—	LQG18HH56NJ00□	56nH ±5%	100MHz	12	100MHz	400mA	0.70Ω	800MHz
—	LQG18HH68NJ00□	68nH ±5%	100MHz	12	100MHz	400mA	0.80Ω	800MHz
—	LQG18HH82NJ00□	82nH ±5%	100MHz	12	100MHz	300mA	0.85Ω	700MHz
—	LQG18HHR10J00□	100nH ±5%	100MHz	12	100MHz	300mA	0.90Ω	600MHz
—	LQG18HHR12J00□	120nH ±5%	100MHz	14	100MHz	300mA	1.10Ω	550MHz
—	LQG18HHR15J00□	150nH ±5%	100MHz	14	100MHz	300mA	1.20Ω	550MHz
—	LQG18HHR18J00□	180nH ±5%	100MHz	14	100MHz	300mA	1.30Ω	500MHz
—	LQG18HHR22J00□	220nH ±5%	100MHz	14	100MHz	300mA	1.50Ω	450MHz
—	LQG18HHR27J00□	270nH ±5%	100MHz	14	100MHz	200mA	1.90Ω	400MHz

Operating temp.range (Self-temp.rise not included): -55 to 125°C

Only for reflow soldering

\*S.R.F: Self Resonant Frequency

Continued on the following page. ↗

Continued from the preceding page. ↘

**Inductance-Frequency Characteristics (Typ.)**

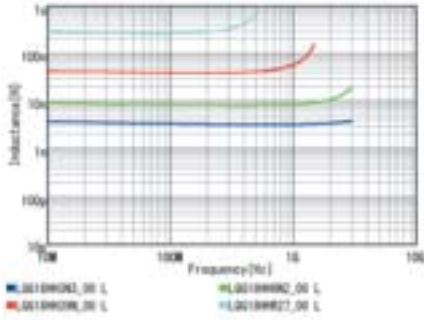

**Q-Frequency Characteristics (Typ.)**

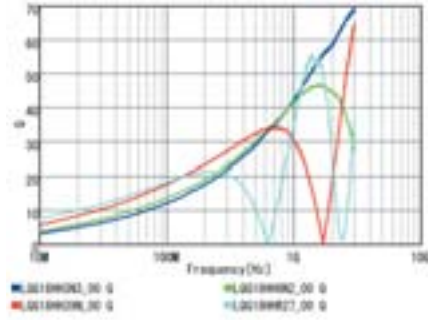

**RF Inductors**

# LQP03TN\_Z2 Series 0201 (0603) inch (mm)

**Appearance/Dimensions**

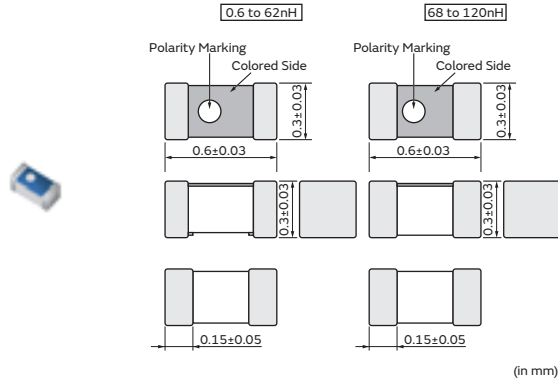

**Packaging**

Code	Packaging	Minimum Quantity
D	ø180mm Paper Taping	15000
J	ø330mm Paper Taping	50000
B	Packing in Bulk	500

**Rated Value (□: packaging code)**

Part Number		Inductance	Inductance Test Frequency	Q (min.)	Q Test Frequency	Rated Current	Max. of DC Resistance	S.R.F* (min.)
Infotainment	Powertrain/Safety							
LQP03TN0N6BZ2□	—	0.6nH ±0.1nH	500MHz	14	500MHz	850mA	0.07Ω	20000MHz
LQP03TN0N6CZ2□	—	0.6nH ±0.2nH	500MHz	14	500MHz	850mA	0.07Ω	20000MHz
LQP03TN0N7BZ2□	—	0.7nH ±0.1nH	500MHz	14	500MHz	800mA	0.08Ω	20000MHz
LQP03TN0N7CZ2□	—	0.7nH ±0.2nH	500MHz	14	500MHz	800mA	0.08Ω	20000MHz
LQP03TN0N8BZ2□	—	0.8nH ±0.1nH	500MHz	14	500MHz	800mA	0.08Ω	18000MHz
LQP03TN0N8CZ2□	—	0.8nH ±0.2nH	500MHz	14	500MHz	800mA	0.08Ω	18000MHz
LQP03TN0N9BZ2□	—	0.9nH ±0.1nH	500MHz	14	500MHz	750mA	0.10Ω	18000MHz
LQP03TN0N9CZ2□	—	0.9nH ±0.2nH	500MHz	14	500MHz	750mA	0.10Ω	18000MHz
LQP03TN1N0BZ2□	—	1.0nH ±0.1nH	500MHz	14	500MHz	750mA	0.10Ω	17000MHz
LQP03TN1N0CZ2□	—	1.0nH ±0.2nH	500MHz	14	500MHz	750mA	0.10Ω	17000MHz
LQP03TN1N1BZ2□	—	1.1nH ±0.1nH	500MHz	14	500MHz	750mA	0.10Ω	17000MHz
LQP03TN1N1CZ2□	—	1.1nH ±0.2nH	500MHz	14	500MHz	750mA	0.10Ω	17000MHz
LQP03TN1N2BZ2□	—	1.2nH ±0.1nH	500MHz	14	500MHz	750mA	0.10Ω	17000MHz
LQP03TN1N2CZ2□	—	1.2nH ±0.2nH	500MHz	14	500MHz	750mA	0.10Ω	17000MHz
LQP03TN1N3BZ2□	—	1.3nH ±0.1nH	500MHz	14	500MHz	600mA	0.15Ω	17000MHz
LQP03TN1N3CZ2□	—	1.3nH ±0.2nH	500MHz	14	500MHz	600mA	0.15Ω	17000MHz
LQP03TN1N4BZ2□	—	1.4nH ±0.1nH	500MHz	14	500MHz	600mA	0.15Ω	16000MHz
LQP03TN1N4CZ2□	—	1.4nH ±0.2nH	500MHz	14	500MHz	600mA	0.15Ω	16000MHz
LQP03TN1N5BZ2□	—	1.5nH ±0.1nH	500MHz	14	500MHz	600mA	0.15Ω	15000MHz
LQP03TN1N5CZ2□	—	1.5nH ±0.2nH	500MHz	14	500MHz	600mA	0.15Ω	15000MHz
LQP03TN1N6BZ2□	—	1.6nH ±0.1nH	500MHz	14	500MHz	600mA	0.15Ω	15000MHz
LQP03TN1N6CZ2□	—	1.6nH ±0.2nH	500MHz	14	500MHz	600mA	0.15Ω	15000MHz
LQP03TN1N7BZ2□	—	1.7nH ±0.1nH	500MHz	14	500MHz	600mA	0.15Ω	15000MHz
LQP03TN1N7CZ2□	—	1.7nH ±0.2nH	500MHz	14	500MHz	600mA	0.15Ω	15000MHz
LQP03TN1N8BZ2□	—	1.8nH ±0.1nH	500MHz	14	500MHz	600mA	0.15Ω	15000MHz
LQP03TN1N8CZ2□	—	1.8nH ±0.2nH	500MHz	14	500MHz	600mA	0.15Ω	15000MHz
LQP03TN1N9BZ2□	—	1.9nH ±0.1nH	500MHz	14	500MHz	600mA	0.15Ω	12500MHz
LQP03TN1N9CZ2□	—	1.9nH ±0.2nH	500MHz	14	500MHz	600mA	0.15Ω	12500MHz
LQP03TN2N0BZ2□	—	2.0nH ±0.1nH	500MHz	14	500MHz	600mA	0.15Ω	12500MHz
LQP03TN2N0CZ2□	—	2.0nH ±0.2nH	500MHz	14	500MHz	600mA	0.15Ω	12500MHz
LQP03TN2N1BZ2□	—	2.1nH ±0.1nH	500MHz	14	500MHz	600mA	0.15Ω	11000MHz
LQP03TN2N1CZ2□	—	2.1nH ±0.2nH	500MHz	14	500MHz	600mA	0.15Ω	11000MHz

Operating temp.range (Self-temp.rise not included): -55 to 125°C

Only for reflow soldering

\*S.R.F: Self Resonant Frequency

Continued on the following page. ↗

Continued from the preceding page. ↘

Part Number		Inductance	Inductance Test Frequency	Q (min.)	Q Test Frequency	Rated Current	Max. of DC Resistance	S.R.F.* (min.)
Infotainment	Powertrain/Safety							
LQP03TN2N2BZ2□	—	2.2nH ±0.1nH	500MHz	14	500MHz	600mA	0.15Ω	11000MHz
LQP03TN2N2CZ2□	—	2.2nH ±0.2nH	500MHz	14	500MHz	600mA	0.15Ω	11000MHz
LQP03TN2N3BZ2□	—	2.3nH ±0.1nH	500MHz	14	500MHz	500mA	0.20Ω	10000MHz
LQP03TN2N3CZ2□	—	2.3nH ±0.2nH	500MHz	14	500MHz	500mA	0.20Ω	10000MHz
LQP03TN2N4BZ2□	—	2.4nH ±0.1nH	500MHz	14	500MHz	500mA	0.20Ω	10000MHz
LQP03TN2N4CZ2□	—	2.4nH ±0.2nH	500MHz	14	500MHz	500mA	0.20Ω	10000MHz
LQP03TN2N5BZ2□	—	2.5nH ±0.1nH	500MHz	14	500MHz	500mA	0.20Ω	10000MHz
LQP03TN2N5CZ2□	—	2.5nH ±0.2nH	500MHz	14	500MHz	500mA	0.20Ω	10000MHz
LQP03TN2N6BZ2□	—	2.6nH ±0.1nH	500MHz	14	500MHz	500mA	0.20Ω	10000MHz
LQP03TN2N6CZ2□	—	2.6nH ±0.2nH	500MHz	14	500MHz	500mA	0.20Ω	10000MHz
LQP03TN2N7BZ2□	—	2.7nH ±0.1nH	500MHz	14	500MHz	500mA	0.20Ω	10000MHz
LQP03TN2N7CZ2□	—	2.7nH ±0.2nH	500MHz	14	500MHz	500mA	0.20Ω	10000MHz
LQP03TN2N8BZ2□	—	2.8nH ±0.1nH	500MHz	14	500MHz	500mA	0.20Ω	9500MHz
LQP03TN2N8CZ2□	—	2.8nH ±0.2nH	500MHz	14	500MHz	500mA	0.20Ω	9500MHz
LQP03TN2N9BZ2□	—	2.9nH ±0.1nH	500MHz	14	500MHz	500mA	0.20Ω	9500MHz
LQP03TN2N9CZ2□	—	2.9nH ±0.2nH	500MHz	14	500MHz	500mA	0.20Ω	9500MHz
LQP03TN3N0BZ2□	—	3.0nH ±0.1nH	500MHz	14	500MHz	450mA	0.25Ω	9500MHz
LQP03TN3N0CZ2□	—	3.0nH ±0.2nH	500MHz	14	500MHz	450mA	0.25Ω	9500MHz
LQP03TN3N1BZ2□	—	3.1nH ±0.1nH	500MHz	14	500MHz	450mA	0.25Ω	8000MHz
LQP03TN3N1CZ2□	—	3.1nH ±0.2nH	500MHz	14	500MHz	450mA	0.25Ω	8000MHz
LQP03TN3N2BZ2□	—	3.2nH ±0.1nH	500MHz	14	500MHz	450mA	0.25Ω	8000MHz
LQP03TN3N2CZ2□	—	3.2nH ±0.2nH	500MHz	14	500MHz	450mA	0.25Ω	8000MHz
LQP03TN3N3BZ2□	—	3.3nH ±0.1nH	500MHz	14	500MHz	450mA	0.25Ω	8000MHz
LQP03TN3N3CZ2□	—	3.3nH ±0.2nH	500MHz	14	500MHz	450mA	0.25Ω	8000MHz
LQP03TN3N4BZ2□	—	3.4nH ±0.1nH	500MHz	14	500MHz	450mA	0.25Ω	7000MHz
LQP03TN3N4CZ2□	—	3.4nH ±0.2nH	500MHz	14	500MHz	450mA	0.25Ω	7000MHz
LQP03TN3N5BZ2□	—	3.5nH ±0.1nH	500MHz	14	500MHz	450mA	0.25Ω	7000MHz
LQP03TN3N5CZ2□	—	3.5nH ±0.2nH	500MHz	14	500MHz	450mA	0.25Ω	7000MHz
LQP03TN3N6BZ2□	—	3.6nH ±0.1nH	500MHz	14	500MHz	400mA	0.30Ω	6000MHz
LQP03TN3N6CZ2□	—	3.6nH ±0.2nH	500MHz	14	500MHz	400mA	0.30Ω	6000MHz
LQP03TN3N7BZ2□	—	3.7nH ±0.1nH	500MHz	14	500MHz	400mA	0.30Ω	6000MHz
LQP03TN3N7CZ2□	—	3.7nH ±0.2nH	500MHz	14	500MHz	400mA	0.30Ω	6000MHz
LQP03TN3N8BZ2□	—	3.8nH ±0.1nH	500MHz	14	500MHz	400mA	0.30Ω	6000MHz
LQP03TN3N8CZ2□	—	3.8nH ±0.2nH	500MHz	14	500MHz	400mA	0.30Ω	6000MHz
LQP03TN3N9BZ2□	—	3.9nH ±0.1nH	500MHz	14	500MHz	400mA	0.30Ω	5700MHz
LQP03TN3N9CZ2□	—	3.9nH ±0.2nH	500MHz	14	500MHz	400mA	0.30Ω	5700MHz
LQP03TN4N0BZ2□	—	4.0nH ±0.1nH	500MHz	14	500MHz	350mA	0.40Ω	5300MHz
LQP03TN4N0CZ2□	—	4.0nH ±0.2nH	500MHz	14	500MHz	350mA	0.40Ω	5300MHz
LQP03TN4N1BZ2□	—	4.1nH ±0.1nH	500MHz	14	500MHz	350mA	0.40Ω	5300MHz
LQP03TN4N1CZ2□	—	4.1nH ±0.2nH	500MHz	14	500MHz	350mA	0.40Ω	5300MHz
LQP03TN4N2BZ2□	—	4.2nH ±0.1nH	500MHz	14	500MHz	350mA	0.40Ω	5300MHz
LQP03TN4N2CZ2□	—	4.2nH ±0.2nH	500MHz	14	500MHz	350mA	0.40Ω	5300MHz
LQP03TN4N3HZ2□	—	4.3nH ±3%	500MHz	14	500MHz	350mA	0.40Ω	5300MHz
LQP03TN4N3JZ2□	—	4.3nH ±5%	500MHz	14	500MHz	350mA	0.40Ω	5300MHz
LQP03TN4N7HZ2□	—	4.7nH ±3%	500MHz	14	500MHz	350mA	0.40Ω	4400MHz
LQP03TN4N7JZ2□	—	4.7nH ±5%	500MHz	14	500MHz	350mA	0.40Ω	4400MHz
LQP03TN5N1HZ2□	—	5.1nH ±3%	500MHz	14	500MHz	350mA	0.40Ω	4200MHz
LQP03TN5N1JZ2□	—	5.1nH ±5%	500MHz	14	500MHz	350mA	0.40Ω	4200MHz
LQP03TN5N6HZ2□	—	5.6nH ±3%	500MHz	14	500MHz	350mA	0.40Ω	4000MHz
LQP03TN5N6JZ2□	—	5.6nH ±5%	500MHz	14	500MHz	350mA	0.40Ω	4000MHz
LQP03TN6N2HZ2□	—	6.2nH ±3%	500MHz	14	500MHz	300mA	0.60Ω	4000MHz
LQP03TN6N2JZ2□	—	6.2nH ±5%	500MHz	14	500MHz	300mA	0.60Ω	4000MHz
LQP03TN6N8HZ2□	—	6.8nH ±3%	500MHz	14	500MHz	300mA	0.60Ω	3900MHz

Operating temp.range (Self-temp.rise not included): -55 to 125°C

Only for reflow soldering

\*S.R.F.: Self Resonant Frequency

Continued on the following page. ↗



Continued from the preceding page. ↘

Part Number		Inductance	Inductance Test Frequency	Q (min.)	Q Test Frequency	Rated Current	Max. of DC Resistance	S.R.F* (min.)
Infotainment	Powertrain/Safety							
LQP03TN6N8JZ2□	—	6.8nH ±5%	500MHz	14	500MHz	300mA	0.60Ω	3900MHz
LQP03TN7N5HZ2□	—	7.5nH ±3%	500MHz	14	500MHz	300mA	0.60Ω	3700MHz
LQP03TN7N5JZ2□	—	7.5nH ±5%	500MHz	14	500MHz	300mA	0.60Ω	3700MHz
LQP03TN8N2HZ2□	—	8.2nH ±3%	500MHz	14	500MHz	250mA	0.70Ω	3600MHz
LQP03TN8N2JZ2□	—	8.2nH ±5%	500MHz	14	500MHz	250mA	0.70Ω	3600MHz
LQP03TN9N1HZ2□	—	9.1nH ±3%	500MHz	14	500MHz	250mA	0.70Ω	3300MHz
LQP03TN9N1JZ2□	—	9.1nH ±5%	500MHz	14	500MHz	250mA	0.70Ω	3300MHz
LQP03TN10NHZ2□	—	10nH ±3%	500MHz	14	500MHz	250mA	0.70Ω	3200MHz
LQP03TN10NJZ2□	—	10nH ±5%	500MHz	14	500MHz	250mA	0.70Ω	3200MHz
LQP03TN11NHZ2□	—	11nH ±3%	500MHz	14	500MHz	250mA	0.80Ω	2900MHz
LQP03TN11NJZ2□	—	11nH ±5%	500MHz	14	500MHz	250mA	0.80Ω	2900MHz
LQP03TN12NHZ2□	—	12nH ±3%	500MHz	12	500MHz	250mA	0.70Ω	2900MHz
LQP03TN12NJZ2□	—	12nH ±5%	500MHz	12	500MHz	250mA	0.70Ω	2900MHz
LQP03TN13NHZ2□	—	13nH ±3%	500MHz	12	500MHz	250mA	0.80Ω	2600MHz
LQP03TN13NJZ2□	—	13nH ±5%	500MHz	12	500MHz	250mA	0.80Ω	2600MHz
LQP03TN15NHZ2□	—	15nH ±3%	500MHz	12	500MHz	250mA	0.70Ω	2600MHz
LQP03TN15NJZ2□	—	15nH ±5%	500MHz	12	500MHz	250mA	0.70Ω	2600MHz
LQP03TN16NHZ2□	—	16nH ±3%	500MHz	12	500MHz	200mA	0.95Ω	2200MHz
LQP03TN16NJZ2□	—	16nH ±5%	500MHz	12	500MHz	200mA	0.95Ω	2200MHz
LQP03TN18NHZ2□	—	18nH ±3%	500MHz	12	500MHz	200mA	0.80Ω	2200MHz
LQP03TN18NJZ2□	—	18nH ±5%	500MHz	12	500MHz	200mA	0.80Ω	2200MHz
LQP03TN20NHZ2□	—	20nH ±3%	500MHz	12	500MHz	150mA	2.30Ω	2200MHz
LQP03TN20NJZ2□	—	20nH ±5%	500MHz	12	500MHz	150mA	2.30Ω	2200MHz
LQP03TN22NHZ2□	—	22nH ±3%	500MHz	12	500MHz	150mA	1.90Ω	2200MHz
LQP03TN22NJZ2□	—	22nH ±5%	500MHz	12	500MHz	150mA	1.90Ω	2200MHz
LQP03TN24NHZ2□	—	24nH ±3%	500MHz	12	500MHz	140mA	2.30Ω	2000MHz
LQP03TN24NJZ2□	—	24nH ±5%	500MHz	12	500MHz	140mA	2.30Ω	2000MHz
LQP03TN27NHZ2□	—	27nH ±3%	500MHz	12	500MHz	140mA	2.30Ω	2000MHz
LQP03TN27NJZ2□	—	27nH ±5%	500MHz	12	500MHz	140mA	2.30Ω	2000MHz
LQP03TN30NHZ2□	—	30nH ±3%	500MHz	9	500MHz	120mA	2.95Ω	1700MHz
LQP03TN30NJZ2□	—	30nH ±5%	500MHz	9	500MHz	120mA	2.95Ω	1700MHz
LQP03TN33NHZ2□	—	33nH ±3%	300MHz	9	300MHz	120mA	2.95Ω	1700MHz
LQP03TN33NJZ2□	—	33nH ±5%	300MHz	9	300MHz	120mA	2.95Ω	1700MHz
LQP03TN36NHZ2□	—	36nH ±3%	300MHz	9	300MHz	120mA	3.00Ω	1500MHz
LQP03TN36NJZ2□	—	36nH ±5%	300MHz	9	300MHz	120mA	3.00Ω	1500MHz
LQP03TN39NHZ2□	—	39nH ±3%	300MHz	9	300MHz	120mA	3.00Ω	1500MHz
LQP03TN39NJZ2□	—	39nH ±5%	300MHz	9	300MHz	120mA	3.00Ω	1500MHz
LQP03TN43NHZ2□	—	43nH ±3%	300MHz	9	300MHz	100mA	3.60Ω	1300MHz
LQP03TN43NJZ2□	—	43nH ±5%	300MHz	9	300MHz	100mA	3.60Ω	1300MHz
LQP03TN47NHZ2□	—	47nH ±3%	300MHz	9	300MHz	100mA	3.60Ω	1300MHz
LQP03TN47NJZ2□	—	47nH ±5%	300MHz	9	300MHz	100mA	3.60Ω	1300MHz
LQP03TN51NHZ2□	—	51nH ±3%	300MHz	9	300MHz	100mA	3.90Ω	1200MHz
LQP03TN51NJZ2□	—	51nH ±5%	300MHz	9	300MHz	100mA	3.90Ω	1200MHz
LQP03TN56NHZ2□	—	56nH ±3%	300MHz	9	300MHz	100mA	3.90Ω	1200MHz
LQP03TN56NJZ2□	—	56nH ±5%	300MHz	9	300MHz	100mA	3.90Ω	1200MHz
LQP03TN62NHZ2□	—	62nH ±3%	300MHz	8	300MHz	100mA	8Ω	1100MHz
LQP03TN62NJZ2□	—	62nH ±5%	300MHz	8	300MHz	100mA	8Ω	1100MHz
LQP03TN68NHZ2□	—	68nH ±3%	300MHz	8	300MHz	100mA	8Ω	1100MHz
LQP03TN68NJZ2□	—	68nH ±5%	300MHz	8	300MHz	100mA	8Ω	1100MHz
LQP03TN75NHZ2□	—	75nH ±3%	300MHz	8	300MHz	100mA	10Ω	1000MHz
LQP03TN75NJZ2□	—	75nH ±5%	300MHz	8	300MHz	100mA	10Ω	1000MHz
LQP03TN82NHZ2□	—	82nH ±3%	300MHz	8	300MHz	100mA	10Ω	1000MHz
LQP03TN82NJZ2□	—	82nH ±5%	300MHz	8	300MHz	100mA	10Ω	1000MHz

Operating temp.range (Self-temp.rise not included): -55 to 125°C

Only for reflow soldering

\*S.R.F: Self Resonant Frequency

Continued on the following page. ↗

Inductors for Power Lines

Inductors for General Circuits

RF Inductors

Continued from the preceding page. ↘

Part Number		Inductance	Inductance Test Frequency	Q (min.)	Q Test Frequency	Rated Current	Max. of DC Resistance	S.R.F* (min.)
Infotainment	Powertrain/Safety							
LQP03TN91NHZ2□	—	91nH ±3%	300MHz	8	300MHz	80mA	10Ω	900MHz
LQP03TN91NJZ2□	—	91nH ±5%	300MHz	8	300MHz	80mA	10Ω	900MHz
LQP03TNR10HZ2□	—	100nH ±3%	300MHz	8	300MHz	80mA	10Ω	900MHz
LQP03TNR10JZ2□	—	100nH ±5%	300MHz	8	300MHz	80mA	10Ω	900MHz
LQP03TNR11HZ2□	—	110nH ±3%	300MHz	8	300MHz	80mA	12Ω	800MHz
LQP03TNR11JZ2□	—	110nH ±5%	300MHz	8	300MHz	80mA	12Ω	800MHz
LQP03TNR12HZ2□	—	120nH ±3%	300MHz	8	300MHz	80mA	12Ω	800MHz
LQP03TNR12JZ2□	—	120nH ±5%	300MHz	8	300MHz	80mA	12Ω	800MHz

Operating temp.range (Self-temp.rise not included): -55 to 125°C

Only for reflow soldering

\*S.R.F: Self Resonant Frequency

### Inductance-Frequency Characteristics (Typ.)

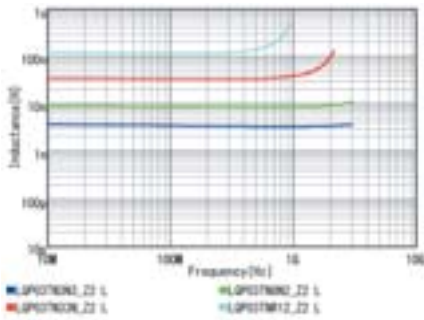

### Q-Frequency Characteristics (Typ.)

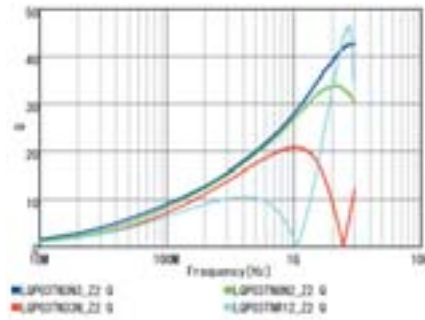

**RF Inductors**

# LQW15AN\_0Z Series 0402 (1005) inch (mm)

**Appearance/Dimensions**

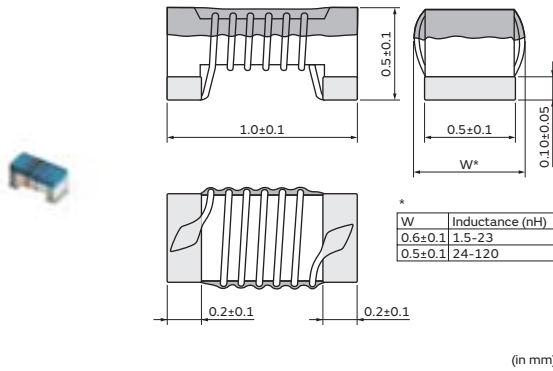

**Packaging**

Code	Packaging	Minimum Quantity
D	ø180mm Paper Taping	10000
B	Packing in Bulk	500

**Rated Value (□: packaging code)**

Part Number		Inductance	Inductance Test Frequency	Q (min.)	Q Test Frequency	Rated Current	Max. of DC Resistance	S.R.F* (min.)
Infotainment	Powertrain/Safety							
LQW15AN1N5B0Z□	—	1.5nH ±0.1nH	100MHz	10	250MHz	1000mA	0.03Ω	18.0GHz
LQW15AN1N5C0Z□	—	1.5nH ±0.2nH	100MHz	10	250MHz	1000mA	0.03Ω	18.0GHz
LQW15AN1N5D0Z□	—	1.5nH ±0.5nH	100MHz	10	250MHz	1000mA	0.03Ω	18.0GHz
LQW15AN1N6C0Z□	—	1.6nH ±0.2nH	100MHz	10	250MHz	750mA	0.07Ω	17.0GHz
LQW15AN1N6D0Z□	—	1.6nH ±0.5nH	100MHz	10	250MHz	750mA	0.07Ω	17.0GHz
LQW15AN1N7C0Z□	—	1.7nH ±0.2nH	100MHz	10	250MHz	640mA	0.10Ω	17.0GHz
LQW15AN1N7D0Z□	—	1.7nH ±0.5nH	100MHz	10	250MHz	640mA	0.10Ω	17.0GHz
LQW15AN1N8C0Z□	—	1.8nH ±0.2nH	100MHz	10	250MHz	460mA	0.16Ω	16.0GHz
LQW15AN1N8D0Z□	—	1.8nH ±0.5nH	100MHz	10	250MHz	460mA	0.16Ω	16.0GHz
LQW15AN2N4B0Z□	—	2.4nH ±0.1nH	100MHz	20	250MHz	850mA	0.05Ω	15.0GHz
LQW15AN2N4C0Z□	—	2.4nH ±0.2nH	100MHz	20	250MHz	850mA	0.05Ω	15.0GHz
LQW15AN2N4D0Z□	—	2.4nH ±0.5nH	100MHz	20	250MHz	850mA	0.05Ω	15.0GHz
LQW15AN2N5B0Z□	—	2.5nH ±0.1nH	100MHz	20	250MHz	850mA	0.05Ω	15.0GHz
LQW15AN2N5C0Z□	—	2.5nH ±0.2nH	100MHz	20	250MHz	850mA	0.05Ω	15.0GHz
LQW15AN2N5D0Z□	—	2.5nH ±0.5nH	100MHz	20	250MHz	850mA	0.05Ω	15.0GHz
LQW15AN2N6B0Z□	—	2.6nH ±0.1nH	100MHz	20	250MHz	850mA	0.05Ω	15.0GHz
LQW15AN2N6C0Z□	—	2.6nH ±0.2nH	100MHz	20	250MHz	850mA	0.05Ω	15.0GHz
LQW15AN2N6D0Z□	—	2.6nH ±0.5nH	100MHz	20	250MHz	850mA	0.05Ω	15.0GHz
LQW15AN2N7B0Z□	—	2.7nH ±0.1nH	100MHz	20	250MHz	850mA	0.05Ω	15.0GHz
LQW15AN2N7C0Z□	—	2.7nH ±0.2nH	100MHz	20	250MHz	850mA	0.05Ω	15.0GHz
LQW15AN2N7D0Z□	—	2.7nH ±0.5nH	100MHz	20	250MHz	850mA	0.05Ω	15.0GHz
LQW15AN2N8B0Z□	—	2.8nH ±0.1nH	100MHz	20	250MHz	850mA	0.05Ω	15.0GHz
LQW15AN2N8C0Z□	—	2.8nH ±0.2nH	100MHz	20	250MHz	850mA	0.05Ω	15.0GHz
LQW15AN2N8D0Z□	—	2.8nH ±0.5nH	100MHz	20	250MHz	850mA	0.05Ω	15.0GHz
LQW15AN2N9B0Z□	—	2.9nH ±0.1nH	100MHz	20	250MHz	750mA	0.07Ω	15.0GHz
LQW15AN2N9C0Z□	—	2.9nH ±0.2nH	100MHz	20	250MHz	750mA	0.07Ω	15.0GHz
LQW15AN2N9D0Z□	—	2.9nH ±0.5nH	100MHz	20	250MHz	750mA	0.07Ω	15.0GHz
LQW15AN3N0B0Z□	—	3.0nH ±0.1nH	100MHz	20	250MHz	750mA	0.07Ω	15.0GHz
LQW15AN3N0C0Z□	—	3.0nH ±0.2nH	100MHz	20	250MHz	750mA	0.07Ω	15.0GHz
LQW15AN3N0D0Z□	—	3.0nH ±0.5nH	100MHz	20	250MHz	750mA	0.07Ω	15.0GHz
LQW15AN3N1B0Z□	—	3.1nH ±0.1nH	100MHz	20	250MHz	570mA	0.13Ω	14.0GHz
LQW15AN3N1C0Z□	—	3.1nH ±0.2nH	100MHz	20	250MHz	570mA	0.13Ω	14.0GHz

Operating temp.range (Self-temp.rise not included): -55 to 125°C

Only for reflow soldering

\*S.R.F: Self Resonant Frequency

Continued on the following page. ↗

Continued from the preceding page. ↘

Part Number		Inductance	Inductance Test Frequency	Q (min.)	Q Test Frequency	Rated Current	Max. of DC Resistance	S.R.F.* (min.)
Infotainment	Powertrain/Safety							
LQW15AN3N1D0Z□	—	3.1nH ±0.5nH	100MHz	20	250MHz	570mA	0.13Ω	14.0GHz
LQW15AN3N2B0Z□	—	3.2nH ±0.1nH	100MHz	15	250MHz	500mA	0.17Ω	14.0GHz
LQW15AN3N2C0Z□	—	3.2nH ±0.2nH	100MHz	15	250MHz	500mA	0.17Ω	14.0GHz
LQW15AN3N2D0Z□	—	3.2nH ±0.5nH	100MHz	15	250MHz	500mA	0.17Ω	14.0GHz
LQW15AN3N9B0Z□	—	3.9nH ±0.1nH	100MHz	25	250MHz	750mA	0.07Ω	10.0GHz
LQW15AN3N9C0Z□	—	3.9nH ±0.2nH	100MHz	25	250MHz	750mA	0.07Ω	10.0GHz
LQW15AN3N9D0Z□	—	3.9nH ±0.5nH	100MHz	25	250MHz	750mA	0.07Ω	10.0GHz
LQW15AN4N1B0Z□	—	4.1nH ±0.1nH	100MHz	25	250MHz	750mA	0.07Ω	10.0GHz
LQW15AN4N1C0Z□	—	4.1nH ±0.2nH	100MHz	25	250MHz	750mA	0.07Ω	10.0GHz
LQW15AN4N1D0Z□	—	4.1nH ±0.5nH	100MHz	25	250MHz	750mA	0.07Ω	10.0GHz
LQW15AN4N3B0Z□	—	4.3nH ±0.1nH	100MHz	25	250MHz	750mA	0.07Ω	10.0GHz
LQW15AN4N3C0Z□	—	4.3nH ±0.2nH	100MHz	25	250MHz	750mA	0.07Ω	10.0GHz
LQW15AN4N3D0Z□	—	4.3nH ±0.5nH	100MHz	25	250MHz	750mA	0.07Ω	10.0GHz
LQW15AN4N4B0Z□	—	4.4nH ±0.1nH	100MHz	25	250MHz	750mA	0.07Ω	8.0GHz
LQW15AN4N4C0Z□	—	4.4nH ±0.2nH	100MHz	25	250MHz	750mA	0.07Ω	8.0GHz
LQW15AN4N4D0Z□	—	4.4nH ±0.5nH	100MHz	25	250MHz	750mA	0.07Ω	8.0GHz
LQW15AN4N5B0Z□	—	4.5nH ±0.1nH	100MHz	25	250MHz	750mA	0.07Ω	8.0GHz
LQW15AN4N5C0Z□	—	4.5nH ±0.2nH	100MHz	25	250MHz	750mA	0.07Ω	8.0GHz
LQW15AN4N5D0Z□	—	4.5nH ±0.5nH	100MHz	25	250MHz	750mA	0.07Ω	8.0GHz
LQW15AN4N6B0Z□	—	4.6nH ±0.1nH	100MHz	25	250MHz	750mA	0.07Ω	8.0GHz
LQW15AN4N6C0Z□	—	4.6nH ±0.2nH	100MHz	25	250MHz	750mA	0.07Ω	8.0GHz
LQW15AN4N6D0Z□	—	4.6nH ±0.5nH	100MHz	25	250MHz	750mA	0.07Ω	8.0GHz
LQW15AN4N7B0Z□	—	4.7nH ±0.1nH	100MHz	25	250MHz	750mA	0.07Ω	8.0GHz
LQW15AN4N7C0Z□	—	4.7nH ±0.2nH	100MHz	25	250MHz	750mA	0.07Ω	8.0GHz
LQW15AN4N7D0Z□	—	4.7nH ±0.5nH	100MHz	25	250MHz	750mA	0.07Ω	8.0GHz
LQW15AN4N8B0Z□	—	4.8nH ±0.1nH	100MHz	25	250MHz	750mA	0.07Ω	8.0GHz
LQW15AN4N8C0Z□	—	4.8nH ±0.2nH	100MHz	25	250MHz	750mA	0.07Ω	8.0GHz
LQW15AN4N8D0Z□	—	4.8nH ±0.5nH	100MHz	25	250MHz	750mA	0.07Ω	8.0GHz
LQW15AN4N9B0Z□	—	4.9nH ±0.1nH	100MHz	25	250MHz	600mA	0.12Ω	8.0GHz
LQW15AN4N9C0Z□	—	4.9nH ±0.2nH	100MHz	25	250MHz	600mA	0.12Ω	8.0GHz
LQW15AN4N9D0Z□	—	4.9nH ±0.5nH	100MHz	25	250MHz	600mA	0.12Ω	8.0GHz
LQW15AN5N0B0Z□	—	5.0nH ±0.1nH	100MHz	25	250MHz	600mA	0.12Ω	8.0GHz
LQW15AN5N0C0Z□	—	5.0nH ±0.2nH	100MHz	25	250MHz	600mA	0.12Ω	8.0GHz
LQW15AN5N0D0Z□	—	5.0nH ±0.5nH	100MHz	25	250MHz	600mA	0.12Ω	8.0GHz
LQW15AN5N1B0Z□	—	5.1nH ±0.1nH	100MHz	25	250MHz	600mA	0.12Ω	8.0GHz
LQW15AN5N1C0Z□	—	5.1nH ±0.2nH	100MHz	25	250MHz	600mA	0.12Ω	8.0GHz
LQW15AN5N1D0Z□	—	5.1nH ±0.5nH	100MHz	25	250MHz	600mA	0.12Ω	8.0GHz
LQW15AN5N8B0Z□	—	5.8nH ±0.1nH	100MHz	25	250MHz	700mA	0.09Ω	8.0GHz
LQW15AN5N8C0Z□	—	5.8nH ±0.2nH	100MHz	25	250MHz	700mA	0.09Ω	8.0GHz
LQW15AN5N8D0Z□	—	5.8nH ±0.5nH	100MHz	25	250MHz	700mA	0.09Ω	8.0GHz
LQW15AN6N2B0Z□	—	6.2nH ±0.1nH	100MHz	25	250MHz	700mA	0.09Ω	8.0GHz
LQW15AN6N2C0Z□	—	6.2nH ±0.2nH	100MHz	25	250MHz	700mA	0.09Ω	8.0GHz
LQW15AN6N2D0Z□	—	6.2nH ±0.5nH	100MHz	25	250MHz	700mA	0.09Ω	8.0GHz
LQW15AN6N3B0Z□	—	6.3nH ±0.1nH	100MHz	25	250MHz	700mA	0.09Ω	6.0GHz
LQW15AN6N3C0Z□	—	6.3nH ±0.2nH	100MHz	25	250MHz	700mA	0.09Ω	6.0GHz
LQW15AN6N3D0Z□	—	6.3nH ±0.5nH	100MHz	25	250MHz	700mA	0.09Ω	6.0GHz
LQW15AN6N4B0Z□	—	6.4nH ±0.1nH	100MHz	25	250MHz	700mA	0.09Ω	6.0GHz
LQW15AN6N4C0Z□	—	6.4nH ±0.2nH	100MHz	25	250MHz	700mA	0.09Ω	6.0GHz
LQW15AN6N4D0Z□	—	6.4nH ±0.5nH	100MHz	25	250MHz	700mA	0.09Ω	6.0GHz
LQW15AN6N5B0Z□	—	6.5nH ±0.1nH	100MHz	25	250MHz	700mA	0.09Ω	6.0GHz
LQW15AN6N5C0Z□	—	6.5nH ±0.2nH	100MHz	25	250MHz	700mA	0.09Ω	6.0GHz
LQW15AN6N5D0Z□	—	6.5nH ±0.5nH	100MHz	25	250MHz	700mA	0.09Ω	6.0GHz
LQW15AN6N6B0Z□	—	6.6nH ±0.1nH	100MHz	25	250MHz	700mA	0.09Ω	6.0GHz

Operating temp.range (Self-temp.rise not included): -55 to 125°C

Only for reflow soldering

\*S.R.F.: Self Resonant Frequency

Continued on the following page. ↗

Continued from the preceding page. ↘

Part Number		Inductance	Inductance Test Frequency	Q (min.)	Q Test Frequency	Rated Current	Max. of DC Resistance	S.R.F* (min.)
Infotainment	Powertrain/Safety							
LQW15AN6N6C0Z□	—	6.6nH ±0.2nH	100MHz	25	250MHz	700mA	0.09Ω	6.0GHz
LQW15AN6N6D0Z□	—	6.6nH ±0.5nH	100MHz	25	250MHz	700mA	0.09Ω	6.0GHz
LQW15AN6N7B0Z□	—	6.7nH ±0.1nH	100MHz	25	250MHz	700mA	0.09Ω	6.0GHz
LQW15AN6N7C0Z□	—	6.7nH ±0.2nH	100MHz	25	250MHz	700mA	0.09Ω	6.0GHz
LQW15AN6N7D0Z□	—	6.7nH ±0.5nH	100MHz	25	250MHz	700mA	0.09Ω	6.0GHz
LQW15AN6N8G0Z□	—	6.8nH ±2%	100MHz	25	250MHz	700mA	0.09Ω	6.0GHz
LQW15AN6N8H0Z□	—	6.8nH ±3%	100MHz	25	250MHz	700mA	0.09Ω	6.0GHz
LQW15AN6N8J0Z□	—	6.8nH ±5%	100MHz	25	250MHz	700mA	0.09Ω	6.0GHz
LQW15AN6N9G0Z□	—	6.9nH ±2%	100MHz	25	250MHz	570mA	0.13Ω	6.0GHz
LQW15AN6N9H0Z□	—	6.9nH ±3%	100MHz	25	250MHz	570mA	0.13Ω	6.0GHz
LQW15AN6N9J0Z□	—	6.9nH ±5%	100MHz	25	250MHz	570mA	0.13Ω	6.0GHz
LQW15AN7N0G0Z□	—	7.0nH ±2%	100MHz	25	250MHz	570mA	0.13Ω	6.0GHz
LQW15AN7N0H0Z□	—	7.0nH ±3%	100MHz	25	250MHz	570mA	0.13Ω	6.0GHz
LQW15AN7N0J0Z□	—	7.0nH ±5%	100MHz	25	250MHz	570mA	0.13Ω	6.0GHz
LQW15AN7N1G0Z□	—	7.1nH ±2%	100MHz	25	250MHz	570mA	0.13Ω	6.0GHz
LQW15AN7N1H0Z□	—	7.1nH ±3%	100MHz	25	250MHz	570mA	0.13Ω	6.0GHz
LQW15AN7N1J0Z□	—	7.1nH ±5%	100MHz	25	250MHz	570mA	0.13Ω	6.0GHz
LQW15AN7N2G0Z□	—	7.2nH ±2%	100MHz	25	250MHz	570mA	0.13Ω	6.0GHz
LQW15AN7N2H0Z□	—	7.2nH ±3%	100MHz	25	250MHz	570mA	0.13Ω	6.0GHz
LQW15AN7N2J0Z□	—	7.2nH ±5%	100MHz	25	250MHz	570mA	0.13Ω	6.0GHz
LQW15AN7N3G0Z□	—	7.3nH ±2%	100MHz	25	250MHz	570mA	0.13Ω	6.0GHz
LQW15AN7N3H0Z□	—	7.3nH ±3%	100MHz	25	250MHz	570mA	0.13Ω	6.0GHz
LQW15AN7N3J0Z□	—	7.3nH ±5%	100MHz	25	250MHz	570mA	0.13Ω	6.0GHz
LQW15AN7N5G0Z□	—	7.5nH ±2%	100MHz	25	250MHz	570mA	0.13Ω	6.0GHz
LQW15AN7N5H0Z□	—	7.5nH ±3%	100MHz	25	250MHz	570mA	0.13Ω	6.0GHz
LQW15AN7N5J0Z□	—	7.5nH ±5%	100MHz	25	250MHz	570mA	0.13Ω	6.0GHz
LQW15AN8N2G0Z□	—	8.2nH ±2%	100MHz	25	250MHz	540mA	0.14Ω	5.5GHz
LQW15AN8N2H0Z□	—	8.2nH ±3%	100MHz	25	250MHz	540mA	0.14Ω	5.5GHz
LQW15AN8N2J0Z□	—	8.2nH ±5%	100MHz	25	250MHz	540mA	0.14Ω	5.5GHz
LQW15AN8N6G0Z□	—	8.6nH ±2%	100MHz	25	250MHz	540mA	0.14Ω	5.5GHz
LQW15AN8N6H0Z□	—	8.6nH ±3%	100MHz	25	250MHz	540mA	0.14Ω	5.5GHz
LQW15AN8N6J0Z□	—	8.6nH ±5%	100MHz	25	250MHz	540mA	0.14Ω	5.5GHz
LQW15AN8N7G0Z□	—	8.7nH ±2%	100MHz	25	250MHz	540mA	0.14Ω	5.5GHz
LQW15AN8N7H0Z□	—	8.7nH ±3%	100MHz	25	250MHz	540mA	0.14Ω	5.5GHz
LQW15AN8N7J0Z□	—	8.7nH ±5%	100MHz	25	250MHz	540mA	0.14Ω	5.5GHz
LQW15AN8N8G0Z□	—	8.8nH ±2%	100MHz	25	250MHz	540mA	0.14Ω	5.5GHz
LQW15AN8N8H0Z□	—	8.8nH ±3%	100MHz	25	250MHz	540mA	0.14Ω	5.5GHz
LQW15AN8N8J0Z□	—	8.8nH ±5%	100MHz	25	250MHz	540mA	0.14Ω	5.5GHz
LQW15AN8N9G0Z□	—	8.9nH ±2%	100MHz	25	250MHz	540mA	0.14Ω	5.5GHz
LQW15AN8N9H0Z□	—	8.9nH ±3%	100MHz	25	250MHz	540mA	0.14Ω	5.5GHz
LQW15AN8N9J0Z□	—	8.9nH ±5%	100MHz	25	250MHz	540mA	0.14Ω	5.5GHz
LQW15AN9N0G0Z□	—	9.0nH ±2%	100MHz	25	250MHz	540mA	0.14Ω	5.5GHz
LQW15AN9N0H0Z□	—	9.0nH ±3%	100MHz	25	250MHz	540mA	0.14Ω	5.5GHz
LQW15AN9N0J0Z□	—	9.0nH ±5%	100MHz	25	250MHz	540mA	0.14Ω	5.5GHz
LQW15AN9N1G0Z□	—	9.1nH ±2%	100MHz	25	250MHz	540mA	0.14Ω	5.5GHz
LQW15AN9N1H0Z□	—	9.1nH ±3%	100MHz	25	250MHz	540mA	0.14Ω	5.5GHz
LQW15AN9N1J0Z□	—	9.1nH ±5%	100MHz	25	250MHz	540mA	0.14Ω	5.5GHz
LQW15AN9N2G0Z□	—	9.2nH ±2%	100MHz	25	250MHz	540mA	0.14Ω	5.5GHz
LQW15AN9N2H0Z□	—	9.2nH ±3%	100MHz	25	250MHz	540mA	0.14Ω	5.5GHz
LQW15AN9N2J0Z□	—	9.2nH ±5%	100MHz	25	250MHz	540mA	0.14Ω	5.5GHz
LQW15AN9N3G0Z□	—	9.3nH ±2%	100MHz	25	250MHz	540mA	0.14Ω	5.5GHz
LQW15AN9N3H0Z□	—	9.3nH ±3%	100MHz	25	250MHz	540mA	0.14Ω	5.5GHz
LQW15AN9N3J0Z□	—	9.3nH ±5%	100MHz	25	250MHz	540mA	0.14Ω	5.5GHz

Operating temp.range (Self-temp.rise not included): -55 to 125°C

Only for reflow soldering

\*S.R.F: Self Resonant Frequency

Continued on the following page. ↗

Inductors for Power Lines

Inductors for General Circuits

RF Inductors

Continued from the preceding page. ↘

Part Number		Inductance	Inductance Test Frequency	Q (min.)	Q Test Frequency	Rated Current	Max. of DC Resistance	S.R.F* (min.)
Infotainment	Powertrain/Safety							
LQW15AN9N4G0Z□	—	9.4nH ±2%	100MHz	25	250MHz	540mA	0.14Ω	5.5GHz
LQW15AN9N4H0Z□	—	9.4nH ±3%	100MHz	25	250MHz	540mA	0.14Ω	5.5GHz
LQW15AN9N4J0Z□	—	9.4nH ±5%	100MHz	25	250MHz	540mA	0.14Ω	5.5GHz
LQW15AN9N5G0Z□	—	9.5nH ±2%	100MHz	25	250MHz	540mA	0.14Ω	5.5GHz
LQW15AN9N5H0Z□	—	9.5nH ±3%	100MHz	25	250MHz	540mA	0.14Ω	5.5GHz
LQW15AN9N5J0Z□	—	9.5nH ±5%	100MHz	25	250MHz	540mA	0.14Ω	5.5GHz
LQW15AN9N6G0Z□	—	9.6nH ±2%	100MHz	25	250MHz	540mA	0.14Ω	5.5GHz
LQW15AN9N6H0Z□	—	9.6nH ±3%	100MHz	25	250MHz	540mA	0.14Ω	5.5GHz
LQW15AN9N6J0Z□	—	9.6nH ±5%	100MHz	25	250MHz	540mA	0.14Ω	5.5GHz
LQW15AN9N7G0Z□	—	9.7nH ±2%	100MHz	25	250MHz	540mA	0.14Ω	5.5GHz
LQW15AN9N7H0Z□	—	9.7nH ±3%	100MHz	25	250MHz	540mA	0.14Ω	5.5GHz
LQW15AN9N7J0Z□	—	9.7nH ±5%	100MHz	25	250MHz	540mA	0.14Ω	5.5GHz
LQW15AN9N8G0Z□	—	9.8nH ±2%	100MHz	25	250MHz	540mA	0.14Ω	5.5GHz
LQW15AN9N8H0Z□	—	9.8nH ±3%	100MHz	25	250MHz	540mA	0.14Ω	5.5GHz
LQW15AN9N8J0Z□	—	9.8nH ±5%	100MHz	25	250MHz	540mA	0.14Ω	5.5GHz
LQW15AN9N9G0Z□	—	9.9nH ±2%	100MHz	25	250MHz	540mA	0.14Ω	5.5GHz
LQW15AN9N9H0Z□	—	9.9nH ±3%	100MHz	25	250MHz	540mA	0.14Ω	5.5GHz
LQW15AN9N9J0Z□	—	9.9nH ±5%	100MHz	25	250MHz	540mA	0.14Ω	5.5GHz
LQW15AN10NG0Z□	—	10nH ±2%	100MHz	25	250MHz	500mA	0.17Ω	5.5GHz
LQW15AN10NH0Z□	—	10nH ±3%	100MHz	25	250MHz	500mA	0.17Ω	5.5GHz
LQW15AN10NJ0Z□	—	10nH ±5%	100MHz	25	250MHz	500mA	0.17Ω	5.5GHz
LQW15AN11NG0Z□	—	11nH ±2%	100MHz	30	250MHz	500mA	0.14Ω	5.5GHz
LQW15AN11NH0Z□	—	11nH ±3%	100MHz	30	250MHz	500mA	0.14Ω	5.5GHz
LQW15AN11NJ0Z□	—	11nH ±5%	100MHz	30	250MHz	500mA	0.14Ω	5.5GHz
LQW15AN12NG0Z□	—	12nH ±2%	100MHz	30	250MHz	500mA	0.14Ω	5.5GHz
LQW15AN12NH0Z□	—	12nH ±3%	100MHz	30	250MHz	500mA	0.14Ω	5.5GHz
LQW15AN12NJ0Z□	—	12nH ±5%	100MHz	30	250MHz	500mA	0.14Ω	5.5GHz
LQW15AN13NG0Z□	—	13nH ±2%	100MHz	25	250MHz	430mA	0.21Ω	5.0GHz
LQW15AN13NH0Z□	—	13nH ±3%	100MHz	25	250MHz	430mA	0.21Ω	5.0GHz
LQW15AN13NJ0Z□	—	13nH ±5%	100MHz	25	250MHz	430mA	0.21Ω	5.0GHz
LQW15AN15NG0Z□	—	15nH ±2%	100MHz	30	250MHz	460mA	0.16Ω	5.0GHz
LQW15AN15NH0Z□	—	15nH ±3%	100MHz	30	250MHz	460mA	0.16Ω	5.0GHz
LQW15AN15NJ0Z□	—	15nH ±5%	100MHz	30	250MHz	460mA	0.16Ω	5.0GHz
LQW15AN16NG0Z□	—	16nH ±2%	100MHz	25	250MHz	370mA	0.24Ω	4.5GHz
LQW15AN16NH0Z□	—	16nH ±3%	100MHz	25	250MHz	370mA	0.24Ω	4.5GHz
LQW15AN16NJ0Z□	—	16nH ±5%	100MHz	25	250MHz	370mA	0.24Ω	4.5GHz
LQW15AN18NG0Z□	—	18nH ±2%	100MHz	25	250MHz	370mA	0.27Ω	4.5GHz
LQW15AN18NH0Z□	—	18nH ±3%	100MHz	25	250MHz	370mA	0.27Ω	4.5GHz
LQW15AN18NJ0Z□	—	18nH ±5%	100MHz	25	250MHz	370mA	0.27Ω	4.5GHz
LQW15AN19NG0Z□	—	19nH ±2%	100MHz	25	250MHz	370mA	0.27Ω	4.5GHz
LQW15AN19NH0Z□	—	19nH ±3%	100MHz	25	250MHz	370mA	0.27Ω	4.5GHz
LQW15AN19NJ0Z□	—	19nH ±5%	100MHz	25	250MHz	370mA	0.27Ω	4.5GHz
LQW15AN20NG0Z□	—	20nH ±2%	100MHz	25	250MHz	370mA	0.27Ω	4.0GHz
LQW15AN20NH0Z□	—	20nH ±3%	100MHz	25	250MHz	370mA	0.27Ω	4.0GHz
LQW15AN20NJ0Z□	—	20nH ±5%	100MHz	25	250MHz	370mA	0.27Ω	4.0GHz
LQW15AN22NG0Z□	—	22nH ±2%	100MHz	25	250MHz	310mA	0.30Ω	4.0GHz
LQW15AN22NH0Z□	—	22nH ±3%	100MHz	25	250MHz	310mA	0.30Ω	4.0GHz
LQW15AN22NJ0Z□	—	22nH ±5%	100MHz	25	250MHz	310mA	0.30Ω	4.0GHz
LQW15AN23NG0Z□	—	23nH ±2%	100MHz	25	250MHz	310mA	0.30Ω	3.8GHz
LQW15AN23NH0Z□	—	23nH ±3%	100MHz	25	250MHz	310mA	0.30Ω	3.8GHz
LQW15AN23NJ0Z□	—	23nH ±5%	100MHz	25	250MHz	310mA	0.30Ω	3.8GHz
LQW15AN24NG0Z□	—	24nH ±2%	100MHz	25	250MHz	280mA	0.52Ω	3.5GHz
LQW15AN24NH0Z□	—	24nH ±3%	100MHz	25	250MHz	280mA	0.52Ω	3.5GHz

Operating temp.range (Self-temp.rise not included): -55 to 125°C

Only for reflow soldering

\*S.R.F: Self Resonant Frequency

Inductors for Power Lines

Inductors for General Circuits

RF Inductors

Continued from the preceding page. ↘

Part Number		Inductance	Inductance Test Frequency	Q (min.)	Q Test Frequency	Rated Current	Max. of DC Resistance	S.R.F* (min.)
Infotainment	Powertrain/Safety							
LQW15AN24NJ0Z□	—	24nH ±5%	100MHz	25	250MHz	280mA	0.52Ω	3.5GHz
LQW15AN27NG0Z□	—	27nH ±2%	100MHz	25	250MHz	280mA	0.52Ω	3.5GHz
LQW15AN27NH0Z□	—	27nH ±3%	100MHz	25	250MHz	280mA	0.52Ω	3.5GHz
LQW15AN27NJ0Z□	—	27nH ±5%	100MHz	25	250MHz	280mA	0.52Ω	3.5GHz
LQW15AN30NG0Z□	—	30nH ±2%	100MHz	25	250MHz	270mA	0.58Ω	3.3GHz
LQW15AN30NH0Z□	—	30nH ±3%	100MHz	25	250MHz	270mA	0.58Ω	3.3GHz
LQW15AN30NJ0Z□	—	30nH ±5%	100MHz	25	250MHz	270mA	0.58Ω	3.3GHz
LQW15AN33NG0Z□	—	33nH ±2%	100MHz	25	250MHz	260mA	0.63Ω	3.2GHz
LQW15AN33NH0Z□	—	33nH ±3%	100MHz	25	250MHz	260mA	0.63Ω	3.2GHz
LQW15AN33NJ0Z□	—	33nH ±5%	100MHz	25	250MHz	260mA	0.63Ω	3.2GHz
LQW15AN36NG0Z□	—	36nH ±2%	100MHz	25	250MHz	260mA	0.63Ω	3.1GHz
LQW15AN36NH0Z□	—	36nH ±3%	100MHz	25	250MHz	260mA	0.63Ω	3.1GHz
LQW15AN36NJ0Z□	—	36nH ±5%	100MHz	25	250MHz	260mA	0.63Ω	3.1GHz
LQW15AN39NG0Z□	—	39nH ±2%	100MHz	25	250MHz	250mA	0.70Ω	3.0GHz
LQW15AN39NH0Z□	—	39nH ±3%	100MHz	25	250MHz	250mA	0.70Ω	3.0GHz
LQW15AN39NJ0Z□	—	39nH ±5%	100MHz	25	250MHz	250mA	0.70Ω	3.0GHz
LQW15AN40NG0Z□	—	40nH ±2%	100MHz	25	250MHz	250mA	0.70Ω	3.0GHz
LQW15AN40NH0Z□	—	40nH ±3%	100MHz	25	250MHz	250mA	0.70Ω	3.0GHz
LQW15AN40NJ0Z□	—	40nH ±5%	100MHz	25	250MHz	250mA	0.70Ω	3.0GHz
LQW15AN43NG0Z□	—	43nH ±2%	100MHz	25	250MHz	250mA	0.70Ω	3.0GHz
LQW15AN43NH0Z□	—	43nH ±3%	100MHz	25	250MHz	250mA	0.70Ω	3.0GHz
LQW15AN43NJ0Z□	—	43nH ±5%	100MHz	25	250MHz	250mA	0.70Ω	3.0GHz
LQW15AN47NG0Z□	—	47nH ±2%	100MHz	25	200MHz	210mA	1.08Ω	2.9GHz
LQW15AN47NH0Z□	—	47nH ±3%	100MHz	25	200MHz	210mA	1.08Ω	2.9GHz
LQW15AN47NJ0Z□	—	47nH ±5%	100MHz	25	200MHz	210mA	1.08Ω	2.9GHz
LQW15AN51NG0Z□	—	51nH ±2%	100MHz	25	200MHz	210mA	1.08Ω	2.85GHz
LQW15AN51NH0Z□	—	51nH ±3%	100MHz	25	200MHz	210mA	1.08Ω	2.85GHz
LQW15AN51NJ0Z□	—	51nH ±5%	100MHz	25	200MHz	210mA	1.08Ω	2.85GHz
LQW15AN56NG0Z□	—	56nH ±2%	100MHz	25	200MHz	200mA	1.17Ω	2.8GHz
LQW15AN56NH0Z□	—	56nH ±3%	100MHz	25	200MHz	200mA	1.17Ω	2.8GHz
LQW15AN56NJ0Z□	—	56nH ±5%	100MHz	25	200MHz	200mA	1.17Ω	2.8GHz
LQW15AN62NG0Z□	—	62nH ±2%	100MHz	20	200MHz	145mA	1.82Ω	2.6GHz
LQW15AN62NH0Z□	—	62nH ±3%	100MHz	20	200MHz	145mA	1.82Ω	2.6GHz
LQW15AN62NJ0Z□	—	62nH ±5%	100MHz	20	200MHz	145mA	1.82Ω	2.6GHz
LQW15AN68NG0Z□	—	68nH ±2%	100MHz	20	200MHz	140mA	1.96Ω	2.5GHz
LQW15AN68NJ0Z□	—	68nH ±5%	100MHz	20	200MHz	140mA	1.96Ω	2.5GHz
LQW15AN72NG0Z□	—	72nH ±2%	100MHz	20	150MHz	135mA	2.10Ω	2.5GHz
LQW15AN72NJ0Z□	—	72nH ±5%	100MHz	20	150MHz	135mA	2.10Ω	2.5GHz
LQW15AN75NG0Z□	—	75nH ±2%	100MHz	20	150MHz	135mA	2.10Ω	2.4GHz
LQW15AN75NJ0Z□	—	75nH ±5%	100MHz	20	150MHz	135mA	2.10Ω	2.4GHz
LQW15AN82NG0Z□	—	82nH ±2%	100MHz	20	150MHz	130mA	2.24Ω	2.3GHz
LQW15AN82NJ0Z□	—	82nH ±5%	100MHz	20	150MHz	130mA	2.24Ω	2.3GHz
LQW15AN91NG0Z□	—	91nH ±2%	100MHz	20	150MHz	125mA	2.38Ω	2.1GHz
LQW15AN91NJ0Z□	—	91nH ±5%	100MHz	20	150MHz	125mA	2.38Ω	2.1GHz
LQW15ANR10J0Z□	—	100nH ±5%	100MHz	20	150MHz	120mA	2.52Ω	1.5GHz
LQW15ANR12J0Z□	—	120nH ±5%	100MHz	20	150MHz	110mA	2.66Ω	1.0GHz

Operating temp.range (Self-temp.rise not included): -55 to 125°C

Only for reflow soldering

\*S.R.F: Self Resonant Frequency

Continued on the following page. ↗

Continued from the preceding page. ↘

### Inductance-Frequency Characteristics (Typ.)

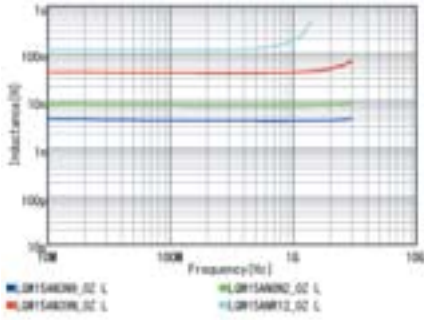

### Q-Frequency Characteristics (Typ.)

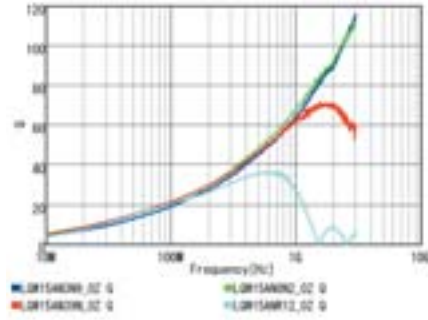



**RF Inductors**

# LQW15AN\_1Z Series 0402 (1005) inch (mm)

**Appearance/Dimensions**

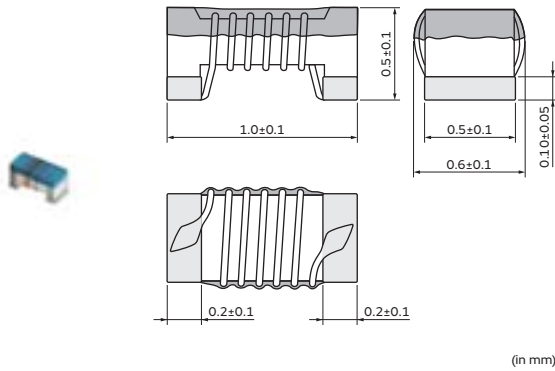

**Packaging**

Code	Packaging	Minimum Quantity
D	ø180mm Paper Taping	10000
B	Packing in Bulk	500

**Rated Value (□: packaging code)**

Part Number		Inductance	Inductance Test Frequency	Q (min.)	Q Test Frequency	Rated Current	Max. of DC Resistance	S.R.F* (min.)
Infotainment	Powertrain/Safety							
LQW15AN1N3C1Z□	—	1.3nH ±0.2nH	100MHz	20	250MHz	1200mA	0.017Ω	16GHz
LQW15AN1N3D1Z□	—	1.3nH ±0.5nH	100MHz	20	250MHz	1200mA	0.017Ω	16GHz
LQW15AN1N4C1Z□	—	1.4nH ±0.2nH	100MHz	25	250MHz	1100mA	0.019Ω	15GHz
LQW15AN1N4D1Z□	—	1.4nH ±0.5nH	100MHz	25	250MHz	1100mA	0.019Ω	15GHz
LQW15AN2N2C1Z□	—	2.2nH ±0.2nH	100MHz	25	250MHz	1000mA	0.027Ω	14GHz
LQW15AN2N2D1Z□	—	2.2nH ±0.5nH	100MHz	25	250MHz	1000mA	0.027Ω	14GHz
LQW15AN2N3C1Z□	—	2.3nH ±0.2nH	100MHz	25	250MHz	1000mA	0.027Ω	14GHz
LQW15AN2N3D1Z□	—	2.3nH ±0.5nH	100MHz	25	250MHz	1000mA	0.027Ω	14GHz
LQW15AN2N4D1Z□	—	2.4nH ±0.5nH	100MHz	25	250MHz	1000mA	0.027Ω	14GHz
LQW15AN3N3D1Z□	—	3.3nH ±0.5nH	100MHz	30	250MHz	900mA	0.040Ω	12GHz
LQW15AN3N4C1Z□	—	3.4nH ±0.2nH	100MHz	30	250MHz	900mA	0.040Ω	12GHz
LQW15AN3N4D1Z□	—	3.4nH ±0.5nH	100MHz	30	250MHz	900mA	0.040Ω	12GHz
LQW15AN3N5C1Z□	—	3.5nH ±0.2nH	100MHz	30	250MHz	900mA	0.040Ω	9.5GHz
LQW15AN3N5D1Z□	—	3.5nH ±0.5nH	100MHz	30	250MHz	900mA	0.040Ω	9.5GHz
LQW15AN3N6C1Z□	—	3.6nH ±0.2nH	100MHz	30	250MHz	900mA	0.040Ω	9.5GHz
LQW15AN3N6D1Z□	—	3.6nH ±0.5nH	100MHz	30	250MHz	900mA	0.040Ω	9.5GHz
LQW15AN3N8C1Z□	—	3.8nH ±0.2nH	100MHz	30	250MHz	900mA	0.040Ω	7GHz
LQW15AN3N8D1Z□	—	3.8nH ±0.5nH	100MHz	30	250MHz	900mA	0.040Ω	7GHz
LQW15AN3N9D1Z□	—	3.9nH ±0.5nH	100MHz	30	250MHz	900mA	0.040Ω	7GHz
LQW15AN4N0C1Z□	—	4.0nH ±0.2nH	100MHz	30	250MHz	800mA	0.051Ω	6.5GHz
LQW15AN4N0D1Z□	—	4.0nH ±0.5nH	100MHz	30	250MHz	800mA	0.051Ω	6.5GHz
LQW15AN4N2C1Z□	—	4.2nH ±0.2nH	100MHz	30	250MHz	800mA	0.051Ω	6.5GHz
LQW15AN4N2D1Z□	—	4.2nH ±0.5nH	100MHz	30	250MHz	800mA	0.051Ω	6.5GHz
LQW15AN4N7D1Z□	—	4.7nH ±0.5nH	100MHz	30	250MHz	800mA	0.051Ω	8GHz
LQW15AN5N1C1Z□	—	5.1nH ±0.2nH	100MHz	30	250MHz	800mA	0.051Ω	8GHz
LQW15AN5N1D1Z□	—	5.1nH ±0.5nH	100MHz	30	250MHz	800mA	0.051Ω	8GHz
LQW15AN5N2C1Z□	—	5.2nH ±0.2nH	100MHz	30	250MHz	800mA	0.051Ω	8GHz
LQW15AN5N2D1Z□	—	5.2nH ±0.5nH	100MHz	30	250MHz	800mA	0.051Ω	8GHz
LQW15AN5N3C1Z□	—	5.3nH ±0.2nH	100MHz	30	250MHz	800mA	0.051Ω	8GHz
LQW15AN5N3D1Z□	—	5.3nH ±0.5nH	100MHz	30	250MHz	800mA	0.051Ω	8GHz
LQW15AN5N4C1Z□	—	5.4nH ±0.2nH	100MHz	30	250MHz	800mA	0.051Ω	8GHz
LQW15AN5N4D1Z□	—	5.4nH ±0.5nH	100MHz	30	250MHz	800mA	0.051Ω	8GHz

Operating temp.range (Self-temp.rise not included): -55 to 125°C

Only for reflow soldering

\*S.R.F: Self Resonant Frequency

Continued on the following page. ↗

Continued from the preceding page. ↘

Part Number		Inductance	Inductance Test Frequency	Q (min.)	Q Test Frequency	Rated Current	Max. of DC Resistance	S.R.F* (min.)
Infotainment	Powertrain/Safety							
LQW15AN5N5C1Z□	—	5.5nH ±0.2nH	100MHz	30	250MHz	800mA	0.051Ω	8GHz
LQW15AN5N5D1Z□	—	5.5nH ±0.5nH	100MHz	30	250MHz	800mA	0.051Ω	8GHz
LQW15AN5N6C1Z□	—	5.6nH ±0.2nH	100MHz	30	250MHz	800mA	0.051Ω	8GHz
LQW15AN5N6D1Z□	—	5.6nH ±0.5nH	100MHz	30	250MHz	800mA	0.051Ω	8GHz
LQW15AN5N7C1Z□	—	5.7nH ±0.2nH	100MHz	30	250MHz	800mA	0.051Ω	8GHz
LQW15AN5N7D1Z□	—	5.7nH ±0.5nH	100MHz	30	250MHz	800mA	0.051Ω	8GHz
LQW15AN5N9C1Z□	—	5.9nH ±0.2nH	100MHz	30	250MHz	760mA	0.056Ω	7.7GHz
LQW15AN5N9D1Z□	—	5.9nH ±0.5nH	100MHz	30	250MHz	760mA	0.056Ω	7.7GHz
LQW15AN6N0C1Z□	—	6.0nH ±0.2nH	100MHz	30	250MHz	760mA	0.056Ω	7.7GHz
LQW15AN6N0D1Z□	—	6.0nH ±0.5nH	100MHz	30	250MHz	760mA	0.056Ω	7.7GHz
LQW15AN6N1C1Z□	—	6.1nH ±0.2nH	100MHz	30	250MHz	760mA	0.056Ω	7.7GHz
LQW15AN6N1D1Z□	—	6.1nH ±0.5nH	100MHz	30	250MHz	760mA	0.056Ω	7.7GHz
LQW15AN7N4C1Z□	—	7.4nH ±0.2nH	100MHz	30	250MHz	750mA	0.058Ω	6.8GHz
LQW15AN7N4D1Z□	—	7.4nH ±0.5nH	100MHz	30	250MHz	750mA	0.058Ω	6.8GHz
LQW15AN7N6C1Z□	—	7.6nH ±0.2nH	100MHz	30	250MHz	750mA	0.058Ω	6.8GHz
LQW15AN7N6D1Z□	—	7.6nH ±0.5nH	100MHz	30	250MHz	750mA	0.058Ω	6.8GHz
LQW15AN7N7C1Z□	—	7.7nH ±0.2nH	100MHz	30	250MHz	750mA	0.058Ω	6.8GHz
LQW15AN7N7D1Z□	—	7.7nH ±0.5nH	100MHz	30	250MHz	750mA	0.058Ω	6.8GHz
LQW15AN7N8C1Z□	—	7.8nH ±0.2nH	100MHz	30	250MHz	750mA	0.058Ω	6.8GHz
LQW15AN7N8D1Z□	—	7.8nH ±0.5nH	100MHz	30	250MHz	750mA	0.058Ω	6.8GHz
LQW15AN7N9C1Z□	—	7.9nH ±0.2nH	100MHz	30	250MHz	640mA	0.079Ω	7.5GHz
LQW15AN7N9D1Z□	—	7.9nH ±0.5nH	100MHz	30	250MHz	640mA	0.079Ω	7.5GHz
LQW15AN8N0C1Z□	—	8.0nH ±0.2nH	100MHz	30	250MHz	640mA	0.079Ω	7.5GHz
LQW15AN8N0D1Z□	—	8.0nH ±0.5nH	100MHz	30	250MHz	640mA	0.079Ω	7.5GHz
LQW15AN8N1C1Z□	—	8.1nH ±0.2nH	100MHz	30	250MHz	640mA	0.079Ω	7.5GHz
LQW15AN8N1D1Z□	—	8.1nH ±0.5nH	100MHz	30	250MHz	640mA	0.079Ω	7.5GHz
LQW15AN8N3C1Z□	—	8.3nH ±0.2nH	100MHz	30	250MHz	640mA	0.079Ω	7.5GHz
LQW15AN8N3D1Z□	—	8.3nH ±0.5nH	100MHz	30	250MHz	640mA	0.079Ω	7.5GHz
LQW15AN8N4C1Z□	—	8.4nH ±0.2nH	100MHz	30	250MHz	640mA	0.079Ω	7.5GHz
LQW15AN8N4D1Z□	—	8.4nH ±0.5nH	100MHz	30	250MHz	640mA	0.079Ω	7.5GHz

Operating temp.range (Self-temp.rise not included): -55 to 125°C

Only for reflow soldering

\*S.R.F: Self Resonant Frequency

**Inductance-Frequency Characteristics (Typ.)**

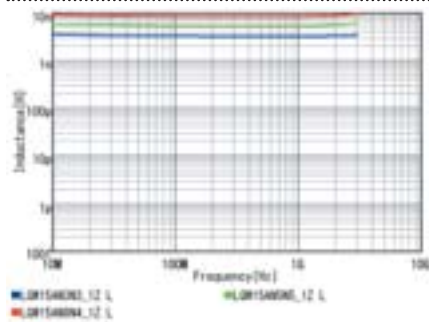

**Q-Frequency Characteristics (Typ.)**

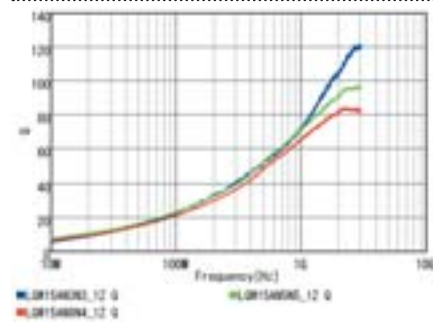

**RF Inductors**

# LQW15AN\_8Z Series 0402 (1005) inch (mm)

**Appearance/Dimensions**

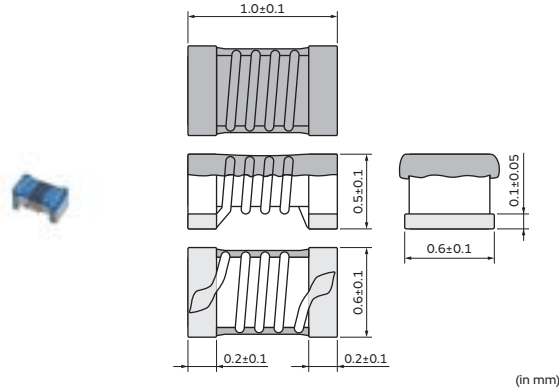

**Packaging**

Code	Packaging	Minimum Quantity
D	ø180mm Paper Taping	10000
B	Packing in Bulk	500

**Rated Value (□: packaging code)**

Part Number		Inductance	Inductance Test Frequency	Q (min.)	Q Test Frequency	Rated Current	Max. of DC Resistance	S.R.F* (min.)
Infotainment	Powertrain/Safety							
LQW15AN1N3C8Z□	—	1.3nH ±0.2nH	100MHz	20	250MHz	3150mA	0.012Ω	18.0GHz
LQW15AN1N3D8Z□	—	1.3nH ±0.5nH	100MHz	20	250MHz	3150mA	0.012Ω	18.0GHz
LQW15AN1N5C8Z□	—	1.5nH ±0.2nH	100MHz	20	250MHz	2100mA	0.028Ω	18.0GHz
LQW15AN1N5D8Z□	—	1.5nH ±0.5nH	100MHz	20	250MHz	2100mA	0.028Ω	18.0GHz
LQW15AN1N6C8Z□	—	1.6nH ±0.2nH	100MHz	20	250MHz	1450mA	0.045Ω	18.0GHz
LQW15AN1N6D8Z□	—	1.6nH ±0.5nH	100MHz	20	250MHz	1450mA	0.045Ω	18.0GHz
LQW15AN1N7C8Z□	—	1.7nH ±0.2nH	100MHz	20	250MHz	1150mA	0.065Ω	18.0GHz
LQW15AN1N7D8Z□	—	1.7nH ±0.5nH	100MHz	20	250MHz	1150mA	0.065Ω	18.0GHz
LQW15AN2N2B8Z□	—	2.2nH ±0.1nH	100MHz	30	250MHz	2530mA	0.022Ω	15.5GHz
LQW15AN2N2C8Z□	—	2.2nH ±0.2nH	100MHz	30	250MHz	2530mA	0.022Ω	15.5GHz
LQW15AN2N2D8Z□	—	2.2nH ±0.5nH	100MHz	30	250MHz	2530mA	0.022Ω	15.5GHz
LQW15AN2N2G8Z□	—	2.2nH ±2%	100MHz	30	250MHz	2530mA	0.022Ω	15.5GHz
LQW15AN2N3B8Z□	—	2.3nH ±0.1nH	100MHz	30	250MHz	2530mA	0.022Ω	15.5GHz
LQW15AN2N3C8Z□	—	2.3nH ±0.2nH	100MHz	30	250MHz	2530mA	0.022Ω	15.5GHz
LQW15AN2N3D8Z□	—	2.3nH ±0.5nH	100MHz	30	250MHz	2530mA	0.022Ω	15.5GHz
LQW15AN2N3G8Z□	—	2.3nH ±2%	100MHz	30	250MHz	2530mA	0.022Ω	15.5GHz
LQW15AN2N4B8Z□	—	2.4nH ±0.1nH	100MHz	30	250MHz	2530mA	0.022Ω	15.5GHz
LQW15AN2N4C8Z□	—	2.4nH ±0.2nH	100MHz	30	250MHz	2530mA	0.022Ω	15.5GHz
LQW15AN2N4D8Z□	—	2.4nH ±0.5nH	100MHz	30	250MHz	2530mA	0.022Ω	15.5GHz
LQW15AN2N4G8Z□	—	2.4nH ±2%	100MHz	30	250MHz	2530mA	0.022Ω	15.5GHz
LQW15AN2N5B8Z□	—	2.5nH ±0.1nH	100MHz	30	250MHz	2100mA	0.030Ω	15.5GHz
LQW15AN2N5C8Z□	—	2.5nH ±0.2nH	100MHz	30	250MHz	2100mA	0.030Ω	15.5GHz
LQW15AN2N5D8Z□	—	2.5nH ±0.5nH	100MHz	30	250MHz	2100mA	0.030Ω	15.5GHz
LQW15AN2N5G8Z□	—	2.5nH ±2%	100MHz	30	250MHz	2100mA	0.030Ω	15.5GHz
LQW15AN2N6B8Z□	—	2.6nH ±0.1nH	100MHz	30	250MHz	1950mA	0.035Ω	14.5GHz
LQW15AN2N6C8Z□	—	2.6nH ±0.2nH	100MHz	30	250MHz	1950mA	0.035Ω	14.5GHz
LQW15AN2N6D8Z□	—	2.6nH ±0.5nH	100MHz	30	250MHz	1950mA	0.035Ω	14.5GHz
LQW15AN2N6G8Z□	—	2.6nH ±2%	100MHz	30	250MHz	1950mA	0.035Ω	14.5GHz
LQW15AN2N7B8Z□	—	2.7nH ±0.1nH	100MHz	28	250MHz	1500mA	0.047Ω	14.0GHz
LQW15AN2N7C8Z□	—	2.7nH ±0.2nH	100MHz	28	250MHz	1500mA	0.047Ω	14.0GHz
LQW15AN2N7D8Z□	—	2.7nH ±0.5nH	100MHz	28	250MHz	1500mA	0.047Ω	14.0GHz

Operating temp.range (Self-temp.rise not included): -55 to 125°C

Only for reflow soldering

\*S.R.F: Self Resonant Frequency

In operating temperatures exceeding +85°C, derating of current is necessary for the LQW15A\_80 series. Please apply the derating curve shown in the chart according to the operating temperature. Please consider "Notice (Rating)."

Continued on the following page. ↗

Continued from the preceding page. ↘

Part Number		Inductance	Inductance Test Frequency	Q (min.)	Q Test Frequency	Rated Current	Max. of DC Resistance	S.R.F* (min.)
Infotainment	Powertrain/Safety							
LQW15AN2N7G8Z□	—	2.7nH ±2%	100MHz	28	250MHz	1500mA	0.047Ω	14.0GHz
LQW15AN2N8B8Z□	—	2.8nH ±0.1nH	100MHz	27	250MHz	1500mA	0.047Ω	13.5GHz
LQW15AN2N8C8Z□	—	2.8nH ±0.2nH	100MHz	27	250MHz	1500mA	0.047Ω	13.5GHz
LQW15AN2N8D8Z□	—	2.8nH ±0.5nH	100MHz	27	250MHz	1500mA	0.047Ω	13.5GHz
LQW15AN2N8G8Z□	—	2.8nH ±2%	100MHz	27	250MHz	1500mA	0.047Ω	13.5GHz
LQW15AN2N9B8Z□	—	2.9nH ±0.1nH	100MHz	25	250MHz	1500mA	0.047Ω	12.5GHz
LQW15AN2N9C8Z□	—	2.9nH ±0.2nH	100MHz	25	250MHz	1500mA	0.047Ω	12.5GHz
LQW15AN2N9D8Z□	—	2.9nH ±0.5nH	100MHz	25	250MHz	1500mA	0.047Ω	12.5GHz
LQW15AN2N9G8Z□	—	2.9nH ±2%	100MHz	25	250MHz	1500mA	0.047Ω	12.5GHz
LQW15AN3N0B8Z□	—	3.0nH ±0.1nH	100MHz	20	250MHz	1350mA	0.063Ω	12.5GHz
LQW15AN3N0C8Z□	—	3.0nH ±0.2nH	100MHz	20	250MHz	1350mA	0.063Ω	12.5GHz
LQW15AN3N0D8Z□	—	3.0nH ±0.5nH	100MHz	20	250MHz	1350mA	0.063Ω	12.5GHz
LQW15AN3N0G8Z□	—	3.0nH ±2%	100MHz	20	250MHz	1350mA	0.063Ω	12.5GHz
LQW15AN3N3B8Z□	—	3.3nH ±0.1nH	100MHz	30	250MHz	2000mA	0.030Ω	14.0GHz
LQW15AN3N3C8Z□	—	3.3nH ±0.2nH	100MHz	30	250MHz	2000mA	0.030Ω	14.0GHz
LQW15AN3N3D8Z□	—	3.3nH ±0.5nH	100MHz	30	250MHz	2000mA	0.030Ω	14.0GHz
LQW15AN3N3G8Z□	—	3.3nH ±2%	100MHz	30	250MHz	2000mA	0.030Ω	14.0GHz
LQW15AN3N4B8Z□	—	3.4nH ±0.1nH	100MHz	30	250MHz	1950mA	0.030Ω	10.0GHz
LQW15AN3N4C8Z□	—	3.4nH ±0.2nH	100MHz	30	250MHz	1950mA	0.030Ω	10.0GHz
LQW15AN3N4D8Z□	—	3.4nH ±0.5nH	100MHz	30	250MHz	1950mA	0.030Ω	10.0GHz
LQW15AN3N4G8Z□	—	3.4nH ±2%	100MHz	30	250MHz	1950mA	0.030Ω	10.0GHz
LQW15AN3N5B8Z□	—	3.5nH ±0.1nH	100MHz	30	250MHz	1950mA	0.030Ω	10.0GHz
LQW15AN3N5C8Z□	—	3.5nH ±0.2nH	100MHz	30	250MHz	1950mA	0.030Ω	10.0GHz
LQW15AN3N5D8Z□	—	3.5nH ±0.5nH	100MHz	30	250MHz	1950mA	0.030Ω	10.0GHz
LQW15AN3N5G8Z□	—	3.5nH ±2%	100MHz	30	250MHz	1950mA	0.030Ω	10.0GHz
LQW15AN3N6B8Z□	—	3.6nH ±0.1nH	100MHz	30	250MHz	1950mA	0.030Ω	10.0GHz
LQW15AN3N6C8Z□	—	3.6nH ±0.2nH	100MHz	30	250MHz	1950mA	0.030Ω	10.0GHz
LQW15AN3N6D8Z□	—	3.6nH ±0.5nH	100MHz	30	250MHz	1950mA	0.030Ω	10.0GHz
LQW15AN3N6G8Z□	—	3.6nH ±2%	100MHz	30	250MHz	1950mA	0.030Ω	10.0GHz
LQW15AN3N7B8Z□	—	3.7nH ±0.1nH	100MHz	35	250MHz	1950mA	0.030Ω	10.0GHz
LQW15AN3N7C8Z□	—	3.7nH ±0.2nH	100MHz	35	250MHz	1950mA	0.030Ω	10.0GHz
LQW15AN3N7D8Z□	—	3.7nH ±0.5nH	100MHz	35	250MHz	1950mA	0.030Ω	10.0GHz
LQW15AN3N7G8Z□	—	3.7nH ±2%	100MHz	35	250MHz	1950mA	0.030Ω	10.0GHz
LQW15AN3N8B8Z□	—	3.8nH ±0.1nH	100MHz	35	250MHz	1950mA	0.030Ω	10.0GHz
LQW15AN3N8C8Z□	—	3.8nH ±0.2nH	100MHz	35	250MHz	1950mA	0.030Ω	10.0GHz
LQW15AN3N8D8Z□	—	3.8nH ±0.5nH	100MHz	35	250MHz	1950mA	0.030Ω	10.0GHz
LQW15AN3N8G8Z□	—	3.8nH ±2%	100MHz	35	250MHz	1950mA	0.030Ω	10.0GHz
LQW15AN3N9B8Z□	—	3.9nH ±0.1nH	100MHz	35	250MHz	1950mA	0.030Ω	10.0GHz
LQW15AN3N9C8Z□	—	3.9nH ±0.2nH	100MHz	35	250MHz	1950mA	0.030Ω	10.0GHz
LQW15AN3N9D8Z□	—	3.9nH ±0.5nH	100MHz	35	250MHz	1950mA	0.030Ω	10.0GHz
LQW15AN3N9G8Z□	—	3.9nH ±2%	100MHz	35	250MHz	1950mA	0.030Ω	10.0GHz
LQW15AN4N0B8Z□	—	4.0nH ±0.1nH	100MHz	30	250MHz	1950mA	0.030Ω	10.0GHz
LQW15AN4N0C8Z□	—	4.0nH ±0.2nH	100MHz	30	250MHz	1950mA	0.030Ω	10.0GHz
LQW15AN4N0D8Z□	—	4.0nH ±0.5nH	100MHz	30	250MHz	1950mA	0.030Ω	10.0GHz
LQW15AN4N0G8Z□	—	4.0nH ±2%	100MHz	30	250MHz	1950mA	0.030Ω	10.0GHz
LQW15AN4N1B8Z□	—	4.1nH ±0.1nH	100MHz	30	250MHz	1800mA	0.044Ω	9.6GHz
LQW15AN4N1C8Z□	—	4.1nH ±0.2nH	100MHz	30	250MHz	1800mA	0.044Ω	9.6GHz
LQW15AN4N1D8Z□	—	4.1nH ±0.5nH	100MHz	30	250MHz	1800mA	0.044Ω	9.6GHz
LQW15AN4N1G8Z□	—	4.1nH ±2%	100MHz	30	250MHz	1800mA	0.044Ω	9.6GHz
LQW15AN4N2B8Z□	—	4.2nH ±0.1nH	100MHz	30	250MHz	1800mA	0.044Ω	9.6GHz
LQW15AN4N2C8Z□	—	4.2nH ±0.2nH	100MHz	30	250MHz	1800mA	0.044Ω	9.6GHz

Operating temp.range (Self-temp.rise not included): -55 to 125°C

Only for reflow soldering

\*S.R.F: Self Resonant Frequency

In operating temperatures exceeding +85°C, derating of current is necessary for the LQW15A\_80 series. Please apply the derating curve shown in the chart according to the operating temperature. Please consider "Notice (Rating)."

Continued on the following page. ↗

Continued from the preceding page. ↘

Part Number		Inductance	Inductance Test Frequency	Q (min.)	Q Test Frequency	Rated Current	Max. of DC Resistance	S.R.F* (min.)
Infotainment	Powertrain/Safety							
LQW15AN4N2D8Z□	—	4.2nH ±0.5nH	100MHz	30	250MHz	1800mA	0.044Ω	9.6GHz
LQW15AN4N2G8Z□	—	4.2nH ±2%	100MHz	30	250MHz	1800mA	0.044Ω	9.6GHz
LQW15AN4N3B8Z□	—	4.3nH ±0.1nH	100MHz	32	250MHz	1800mA	0.044Ω	9.6GHz
LQW15AN4N3C8Z□	—	4.3nH ±0.2nH	100MHz	32	250MHz	1800mA	0.044Ω	9.6GHz
LQW15AN4N3D8Z□	—	4.3nH ±0.5nH	100MHz	32	250MHz	1800mA	0.044Ω	9.6GHz
LQW15AN4N3G8Z□	—	4.3nH ±2%	100MHz	32	250MHz	1800mA	0.044Ω	9.6GHz
LQW15AN4N4B8Z□	—	4.4nH ±0.1nH	100MHz	34	250MHz	1600mA	0.052Ω	9.6GHz
LQW15AN4N4C8Z□	—	4.4nH ±0.2nH	100MHz	34	250MHz	1600mA	0.052Ω	9.6GHz
LQW15AN4N4D8Z□	—	4.4nH ±0.5nH	100MHz	34	250MHz	1600mA	0.052Ω	9.6GHz
LQW15AN4N4G8Z□	—	4.4nH ±2%	100MHz	34	250MHz	1600mA	0.052Ω	9.6GHz
LQW15AN4N5B8Z□	—	4.5nH ±0.1nH	100MHz	34	250MHz	1450mA	0.060Ω	9.6GHz
LQW15AN4N5C8Z□	—	4.5nH ±0.2nH	100MHz	34	250MHz	1450mA	0.060Ω	9.6GHz
LQW15AN4N5D8Z□	—	4.5nH ±0.5nH	100MHz	34	250MHz	1450mA	0.060Ω	9.6GHz
LQW15AN4N5G8Z□	—	4.5nH ±2%	100MHz	34	250MHz	1450mA	0.060Ω	9.6GHz
LQW15AN4N6B8Z□	—	4.6nH ±0.1nH	100MHz	32	250MHz	1450mA	0.060Ω	9.6GHz
LQW15AN4N6C8Z□	—	4.6nH ±0.2nH	100MHz	32	250MHz	1450mA	0.060Ω	9.6GHz
LQW15AN4N6D8Z□	—	4.6nH ±0.5nH	100MHz	32	250MHz	1450mA	0.060Ω	9.6GHz
LQW15AN4N6G8Z□	—	4.6nH ±2%	100MHz	32	250MHz	1450mA	0.060Ω	9.6GHz
LQW15AN4N7B8Z□	—	4.7nH ±0.1nH	100MHz	31	250MHz	1200mA	0.071Ω	8.0GHz
LQW15AN4N7C8Z□	—	4.7nH ±0.2nH	100MHz	31	250MHz	1200mA	0.071Ω	8.0GHz
LQW15AN4N7D8Z□	—	4.7nH ±0.5nH	100MHz	31	250MHz	1200mA	0.071Ω	8.0GHz
LQW15AN4N7G8Z□	—	4.7nH ±2%	100MHz	31	250MHz	1200mA	0.071Ω	8.0GHz
LQW15AN4N8B8Z□	—	4.8nH ±0.1nH	100MHz	30	250MHz	1200mA	0.071Ω	8.0GHz
LQW15AN4N8C8Z□	—	4.8nH ±0.2nH	100MHz	30	250MHz	1200mA	0.071Ω	8.0GHz
LQW15AN4N8D8Z□	—	4.8nH ±0.5nH	100MHz	30	250MHz	1200mA	0.071Ω	8.0GHz
LQW15AN4N8G8Z□	—	4.8nH ±2%	100MHz	30	250MHz	1200mA	0.071Ω	8.0GHz
LQW15AN4N9B8Z□	—	4.9nH ±0.1nH	100MHz	27	250MHz	1200mA	0.071Ω	8.0GHz
LQW15AN4N9C8Z□	—	4.9nH ±0.2nH	100MHz	27	250MHz	1200mA	0.071Ω	8.0GHz
LQW15AN4N9D8Z□	—	4.9nH ±0.5nH	100MHz	27	250MHz	1200mA	0.071Ω	8.0GHz
LQW15AN4N9G8Z□	—	4.9nH ±2%	100MHz	27	250MHz	1200mA	0.071Ω	8.0GHz
LQW15AN5N0B8Z□	—	5.0nH ±0.1nH	100MHz	32	250MHz	1770mA	0.040Ω	10.0GHz
LQW15AN5N0C8Z□	—	5.0nH ±0.2nH	100MHz	32	250MHz	1770mA	0.040Ω	10.0GHz
LQW15AN5N0D8Z□	—	5.0nH ±0.5nH	100MHz	32	250MHz	1770mA	0.040Ω	10.0GHz
LQW15AN5N0G8Z□	—	5.0nH ±2%	100MHz	32	250MHz	1770mA	0.040Ω	10.0GHz
LQW15AN5N1B8Z□	—	5.1nH ±0.1nH	100MHz	35	250MHz	1770mA	0.040Ω	8.0GHz
LQW15AN5N1C8Z□	—	5.1nH ±0.2nH	100MHz	35	250MHz	1770mA	0.040Ω	8.0GHz
LQW15AN5N1D8Z□	—	5.1nH ±0.5nH	100MHz	35	250MHz	1770mA	0.040Ω	8.0GHz
LQW15AN5N1G8Z□	—	5.1nH ±2%	100MHz	35	250MHz	1770mA	0.040Ω	8.0GHz
LQW15AN5N2B8Z□	—	5.2nH ±0.1nH	100MHz	35	250MHz	1770mA	0.040Ω	8.0GHz
LQW15AN5N2C8Z□	—	5.2nH ±0.2nH	100MHz	35	250MHz	1770mA	0.040Ω	8.0GHz
LQW15AN5N2D8Z□	—	5.2nH ±0.5nH	100MHz	35	250MHz	1770mA	0.040Ω	8.0GHz
LQW15AN5N2G8Z□	—	5.2nH ±2%	100MHz	35	250MHz	1770mA	0.040Ω	8.0GHz
LQW15AN5N3B8Z□	—	5.3nH ±0.1nH	100MHz	35	250MHz	1770mA	0.040Ω	8.0GHz
LQW15AN5N3C8Z□	—	5.3nH ±0.2nH	100MHz	35	250MHz	1770mA	0.040Ω	8.0GHz
LQW15AN5N3D8Z□	—	5.3nH ±0.5nH	100MHz	35	250MHz	1770mA	0.040Ω	8.0GHz
LQW15AN5N3G8Z□	—	5.3nH ±2%	100MHz	35	250MHz	1770mA	0.040Ω	8.0GHz
LQW15AN5N4B8Z□	—	5.4nH ±0.1nH	100MHz	35	250MHz	1770mA	0.040Ω	8.0GHz
LQW15AN5N4C8Z□	—	5.4nH ±0.2nH	100MHz	35	250MHz	1770mA	0.040Ω	8.0GHz
LQW15AN5N4D8Z□	—	5.4nH ±0.5nH	100MHz	35	250MHz	1770mA	0.040Ω	8.0GHz
LQW15AN5N4G8Z□	—	5.4nH ±2%	100MHz	35	250MHz	1770mA	0.040Ω	8.0GHz
LQW15AN5N5B8Z□	—	5.5nH ±0.1nH	100MHz	35	250MHz	1770mA	0.040Ω	8.0GHz

Operating temp.range (Self-temp. rise not included): -55 to 125°C

Only for reflow soldering

\*S.R.F: Self Resonant Frequency

In operating temperatures exceeding +85°C, derating of current is necessary for the LQW15A\_80 series. Please apply the derating curve shown in the chart according to the operating temperature. Please consider "Notice (Rating)."

Continued on the following page. ↗

Continued from the preceding page. ↘

Part Number		Inductance	Inductance Test Frequency	Q (min.)	Q Test Frequency	Rated Current	Max. of DC Resistance	S.R.F.* (min.)
Infotainment	Powertrain/Safety							
LQW15AN5N5C8Z□	—	5.5nH ±0.2nH	100MHz	35	250MHz	1770mA	0.040Ω	8.0GHz
LQW15AN5N5D8Z□	—	5.5nH ±0.5nH	100MHz	35	250MHz	1770mA	0.040Ω	8.0GHz
LQW15AN5N5G8Z□	—	5.5nH ±2%	100MHz	35	250MHz	1770mA	0.040Ω	8.0GHz
LQW15AN5N6B8Z□	—	5.6nH ±0.1nH	100MHz	35	250MHz	1770mA	0.040Ω	8.0GHz
LQW15AN5N6C8Z□	—	5.6nH ±0.2nH	100MHz	35	250MHz	1770mA	0.040Ω	8.0GHz
LQW15AN5N6D8Z□	—	5.6nH ±0.5nH	100MHz	35	250MHz	1770mA	0.040Ω	8.0GHz
LQW15AN5N6G8Z□	—	5.6nH ±2%	100MHz	35	250MHz	1770mA	0.040Ω	8.0GHz
LQW15AN5N7B8Z□	—	5.7nH ±0.1nH	100MHz	30	250MHz	1770mA	0.040Ω	8.0GHz
LQW15AN5N7C8Z□	—	5.7nH ±0.2nH	100MHz	30	250MHz	1770mA	0.040Ω	8.0GHz
LQW15AN5N7D8Z□	—	5.7nH ±0.5nH	100MHz	30	250MHz	1770mA	0.040Ω	8.0GHz
LQW15AN5N7G8Z□	—	5.7nH ±2%	100MHz	30	250MHz	1770mA	0.040Ω	8.0GHz
LQW15AN5N8B8Z□	—	5.8nH ±0.1nH	100MHz	30	250MHz	1770mA	0.040Ω	8.0GHz
LQW15AN5N8C8Z□	—	5.8nH ±0.2nH	100MHz	30	250MHz	1770mA	0.040Ω	8.0GHz
LQW15AN5N8D8Z□	—	5.8nH ±0.5nH	100MHz	30	250MHz	1770mA	0.040Ω	8.0GHz
LQW15AN5N8G8Z□	—	5.8nH ±2%	100MHz	30	250MHz	1770mA	0.040Ω	8.0GHz
LQW15AN5N9B8Z□	—	5.9nH ±0.1nH	100MHz	30	250MHz	1770mA	0.040Ω	8.0GHz
LQW15AN5N9C8Z□	—	5.9nH ±0.2nH	100MHz	30	250MHz	1770mA	0.040Ω	8.0GHz
LQW15AN5N9D8Z□	—	5.9nH ±0.5nH	100MHz	30	250MHz	1770mA	0.040Ω	8.0GHz
LQW15AN5N9G8Z□	—	5.9nH ±2%	100MHz	30	250MHz	1770mA	0.040Ω	8.0GHz
LQW15AN6N0B8Z□	—	6.0nH ±0.1nH	100MHz	32	250MHz	1600mA	0.056Ω	8.0GHz
LQW15AN6N0C8Z□	—	6.0nH ±0.2nH	100MHz	32	250MHz	1600mA	0.056Ω	8.0GHz
LQW15AN6N0D8Z□	—	6.0nH ±0.5nH	100MHz	32	250MHz	1600mA	0.056Ω	8.0GHz
LQW15AN6N0G8Z□	—	6.0nH ±2%	100MHz	32	250MHz	1600mA	0.056Ω	8.0GHz
LQW15AN6N1B8Z□	—	6.1nH ±0.1nH	100MHz	32	250MHz	1600mA	0.056Ω	8.0GHz
LQW15AN6N1C8Z□	—	6.1nH ±0.2nH	100MHz	32	250MHz	1600mA	0.056Ω	8.0GHz
LQW15AN6N1D8Z□	—	6.1nH ±0.5nH	100MHz	32	250MHz	1600mA	0.056Ω	8.0GHz
LQW15AN6N1G8Z□	—	6.1nH ±2%	100MHz	32	250MHz	1600mA	0.056Ω	8.0GHz
LQW15AN6N2B8Z□	—	6.2nH ±0.1nH	100MHz	33	250MHz	1600mA	0.056Ω	8.0GHz
LQW15AN6N2C8Z□	—	6.2nH ±0.2nH	100MHz	33	250MHz	1600mA	0.056Ω	8.0GHz
LQW15AN6N2D8Z□	—	6.2nH ±0.5nH	100MHz	33	250MHz	1600mA	0.056Ω	8.0GHz
LQW15AN6N2G8Z□	—	6.2nH ±2%	100MHz	33	250MHz	1600mA	0.056Ω	8.0GHz
LQW15AN6N3G8Z□	—	6.3nH ±2%	100MHz	32	250MHz	1600mA	0.057Ω	7.8GHz
LQW15AN6N3J8Z□	—	6.3nH ±5%	100MHz	32	250MHz	1600mA	0.057Ω	7.8GHz
LQW15AN6N4G8Z□	—	6.4nH ±2%	100MHz	33	250MHz	1380mA	0.065Ω	7.0GHz
LQW15AN6N4J8Z□	—	6.4nH ±5%	100MHz	33	250MHz	1380mA	0.065Ω	7.0GHz
LQW15AN6N5G8Z□	—	6.5nH ±2%	100MHz	32	250MHz	1380mA	0.065Ω	7.0GHz
LQW15AN6N5J8Z□	—	6.5nH ±5%	100MHz	32	250MHz	1380mA	0.065Ω	7.0GHz
LQW15AN6N6G8Z□	—	6.6nH ±2%	100MHz	30	250MHz	1280mA	0.078Ω	7.0GHz
LQW15AN6N6J8Z□	—	6.6nH ±5%	100MHz	30	250MHz	1280mA	0.078Ω	7.0GHz
LQW15AN6N7G8Z□	—	6.7nH ±2%	100MHz	30	250MHz	1280mA	0.078Ω	7.0GHz
LQW15AN6N7J8Z□	—	6.7nH ±5%	100MHz	30	250MHz	1280mA	0.078Ω	7.0GHz
LQW15AN6N8G8Z□	—	6.8nH ±2%	100MHz	30	250MHz	1450mA	0.068Ω	7.0GHz
LQW15AN6N8J8Z□	—	6.8nH ±5%	100MHz	30	250MHz	1450mA	0.068Ω	7.0GHz
LQW15AN6N9G8Z□	—	6.9nH ±2%	100MHz	32	250MHz	1420mA	0.069Ω	8.5GHz
LQW15AN6N9J8Z□	—	6.9nH ±5%	100MHz	32	250MHz	1420mA	0.069Ω	8.5GHz
LQW15AN7N0G8Z□	—	7.0nH ±2%	100MHz	33	250MHz	1420mA	0.069Ω	8.0GHz
LQW15AN7N0J8Z□	—	7.0nH ±5%	100MHz	33	250MHz	1420mA	0.069Ω	8.0GHz
LQW15AN7N1G8Z□	—	7.1nH ±2%	100MHz	32	250MHz	1420mA	0.069Ω	7.0GHz
LQW15AN7N1J8Z□	—	7.1nH ±5%	100MHz	32	250MHz	1420mA	0.069Ω	7.0GHz
LQW15AN7N2G8Z□	—	7.2nH ±2%	100MHz	32	250MHz	1700mA	0.050Ω	7.0GHz
LQW15AN7N2J8Z□	—	7.2nH ±5%	100MHz	32	250MHz	1700mA	0.050Ω	7.0GHz

Operating temp.range (Self-temp.rise not included): -55 to 125°C

Only for reflow soldering

\*S.R.F: Self Resonant Frequency

In operating temperatures exceeding +85°C, derating of current is necessary for the LQW15A\_80 series. Please apply the derating curve shown in the chart according to the operating temperature. Please consider "Notice (Rating)."

Continued on the following page. ↗

Continued from the preceding page. ↘

Part Number		Inductance	Inductance Test Frequency	Q (min.)	Q Test Frequency	Rated Current	Max. of DC Resistance	S.R.F* (min.)
Infotainment	Powertrain/Safety							
LQW15AN7N3G8Z□	—	7.3nH ±2%	100MHz	32	250MHz	1700mA	0.050Ω	7.0GHz
LQW15AN7N3J8Z□	—	7.3nH ±5%	100MHz	32	250MHz	1700mA	0.050Ω	7.0GHz
LQW15AN7N4G8Z□	—	7.4nH ±2%	100MHz	30	250MHz	1700mA	0.050Ω	7.0GHz
LQW15AN7N4J8Z□	—	7.4nH ±5%	100MHz	30	250MHz	1700mA	0.050Ω	7.0GHz
LQW15AN7N5G8Z□	—	7.5nH ±2%	100MHz	35	250MHz	1700mA	0.050Ω	7.0GHz
LQW15AN7N5J8Z□	—	7.5nH ±5%	100MHz	35	250MHz	1700mA	0.050Ω	7.0GHz
LQW15AN7N6G8Z□	—	7.6nH ±2%	100MHz	30	250MHz	1700mA	0.050Ω	7.0GHz
LQW15AN7N6J8Z□	—	7.6nH ±5%	100MHz	30	250MHz	1700mA	0.050Ω	7.0GHz
LQW15AN7N7G8Z□	—	7.7nH ±2%	100MHz	30	250MHz	1700mA	0.050Ω	7.0GHz
LQW15AN7N7J8Z□	—	7.7nH ±5%	100MHz	30	250MHz	1700mA	0.050Ω	7.0GHz
LQW15AN7N8G8Z□	—	7.8nH ±2%	100MHz	30	250MHz	1700mA	0.050Ω	7.0GHz
LQW15AN7N8J8Z□	—	7.8nH ±5%	100MHz	30	250MHz	1700mA	0.050Ω	7.0GHz
LQW15AN7N9G8Z□	—	7.9nH ±2%	100MHz	30	250MHz	1700mA	0.050Ω	7.0GHz
LQW15AN7N9J8Z□	—	7.9nH ±5%	100MHz	30	250MHz	1700mA	0.050Ω	7.0GHz
LQW15AN8N0G8Z□	—	8.0nH ±2%	100MHz	30	250MHz	1700mA	0.050Ω	7.0GHz
LQW15AN8N0J8Z□	—	8.0nH ±5%	100MHz	30	250MHz	1700mA	0.050Ω	7.0GHz
LQW15AN8N1G8Z□	—	8.1nH ±2%	100MHz	32	250MHz	1500mA	0.069Ω	6.5GHz
LQW15AN8N1J8Z□	—	8.1nH ±5%	100MHz	32	250MHz	1500mA	0.069Ω	6.5GHz
LQW15AN8N2G8Z□	—	8.2nH ±2%	100MHz	32	250MHz	1500mA	0.069Ω	6.5GHz
LQW15AN8N2J8Z□	—	8.2nH ±5%	100MHz	32	250MHz	1500mA	0.069Ω	6.5GHz
LQW15AN8N3G8Z□	—	8.3nH ±2%	100MHz	32	250MHz	1500mA	0.069Ω	6.5GHz
LQW15AN8N3J8Z□	—	8.3nH ±5%	100MHz	32	250MHz	1500mA	0.069Ω	6.5GHz
LQW15AN8N4G8Z□	—	8.4nH ±2%	100MHz	32	250MHz	1500mA	0.069Ω	6.5GHz
LQW15AN8N4J8Z□	—	8.4nH ±5%	100MHz	32	250MHz	1500mA	0.069Ω	6.5GHz
LQW15AN8N5G8Z□	—	8.5nH ±2%	100MHz	32	250MHz	1500mA	0.069Ω	6.5GHz
LQW15AN8N5J8Z□	—	8.5nH ±5%	100MHz	32	250MHz	1500mA	0.069Ω	6.5GHz
LQW15AN8N6G8Z□	—	8.6nH ±2%	100MHz	31	250MHz	1420mA	0.070Ω	6.5GHz
LQW15AN8N6J8Z□	—	8.6nH ±5%	100MHz	31	250MHz	1420mA	0.070Ω	6.5GHz
LQW15AN8N7G8Z□	—	8.7nH ±2%	100MHz	31	250MHz	1420mA	0.070Ω	6.5GHz
LQW15AN8N7J8Z□	—	8.7nH ±5%	100MHz	31	250MHz	1420mA	0.070Ω	6.5GHz
LQW15AN8N8G8Z□	—	8.8nH ±2%	100MHz	31	250MHz	1420mA	0.070Ω	6.5GHz
LQW15AN8N8J8Z□	—	8.8nH ±5%	100MHz	31	250MHz	1420mA	0.070Ω	6.5GHz
LQW15AN8N9G8Z□	—	8.9nH ±2%	100MHz	31	250MHz	1420mA	0.070Ω	6.5GHz
LQW15AN8N9J8Z□	—	8.9nH ±5%	100MHz	31	250MHz	1420mA	0.070Ω	6.5GHz
LQW15AN9N0G8Z□	—	9.0nH ±2%	100MHz	30	250MHz	1420mA	0.070Ω	6.5GHz
LQW15AN9N0J8Z□	—	9.0nH ±5%	100MHz	30	250MHz	1420mA	0.070Ω	6.5GHz
LQW15AN9N1G8Z□	—	9.1nH ±2%	100MHz	32	250MHz	1400mA	0.080Ω	6.5GHz
LQW15AN9N1J8Z□	—	9.1nH ±5%	100MHz	32	250MHz	1400mA	0.080Ω	6.5GHz
LQW15AN9N2G8Z□	—	9.2nH ±2%	100MHz	32	250MHz	1400mA	0.081Ω	6.0GHz
LQW15AN9N2J8Z□	—	9.2nH ±5%	100MHz	32	250MHz	1400mA	0.081Ω	6.0GHz
LQW15AN9N3G8Z□	—	9.3nH ±2%	100MHz	34	250MHz	1400mA	0.081Ω	6.0GHz
LQW15AN9N3J8Z□	—	9.3nH ±5%	100MHz	34	250MHz	1400mA	0.081Ω	6.0GHz
LQW15AN9N4G8Z□	—	9.4nH ±2%	100MHz	33	250MHz	1400mA	0.081Ω	6.0GHz
LQW15AN9N4J8Z□	—	9.4nH ±5%	100MHz	33	250MHz	1400mA	0.081Ω	6.0GHz
LQW15AN9N5G8Z□	—	9.5nH ±2%	100MHz	32	250MHz	1400mA	0.081Ω	6.0GHz
LQW15AN9N5J8Z□	—	9.5nH ±5%	100MHz	32	250MHz	1400mA	0.081Ω	6.0GHz
LQW15AN9N6G8Z□	—	9.6nH ±2%	100MHz	33	250MHz	1400mA	0.081Ω	6.0GHz
LQW15AN9N6J8Z□	—	9.6nH ±5%	100MHz	33	250MHz	1400mA	0.081Ω	6.0GHz
LQW15AN9N7G8Z□	—	9.7nH ±2%	100MHz	33	250MHz	1400mA	0.081Ω	6.0GHz
LQW15AN9N7J8Z□	—	9.7nH ±5%	100MHz	33	250MHz	1400mA	0.081Ω	6.0GHz
LQW15AN9N8G8Z□	—	9.8nH ±2%	100MHz	34	250MHz	1400mA	0.081Ω	6.0GHz

Operating temp.range (Self-temp.rise not included): -55 to 125°C

Only for reflow soldering

\*S.R.F: Self Resonant Frequency

In operating temperatures exceeding +85°C, derating of current is necessary for the LQW15A\_80 series. Please apply the derating curve shown in the chart according to the operating temperature. Please consider "Notice (Rating)."

Continued on the following page. ↗

Continued from the preceding page. ↘

Part Number		Inductance	Inductance Test Frequency	Q (min.)	Q Test Frequency	Rated Current	Max. of DC Resistance	S.R.F.* (min.)
Infotainment	Powertrain/Safety							
LQW15AN9N8J8Z□	—	9.8nH ±5%	100MHz	34	250MHz	1400mA	0.081Ω	6.0GHz
LQW15AN9N9G8Z□	—	9.9nH ±2%	100MHz	32	250MHz	1400mA	0.081Ω	6.0GHz
LQW15AN9N9J8Z□	—	9.9nH ±5%	100MHz	32	250MHz	1400mA	0.081Ω	6.0GHz
LQW15AN10NG8Z□	—	10nH ±2%	100MHz	31	250MHz	1400mA	0.081Ω	6.0GHz
LQW15AN10NJ8Z□	—	10nH ±5%	100MHz	31	250MHz	1400mA	0.081Ω	6.0GHz
LQW15AN11NG8Z□	—	11nH ±2%	100MHz	32	250MHz	1400mA	0.083Ω	6.2GHz
LQW15AN11NJ8Z□	—	11nH ±5%	100MHz	32	250MHz	1400mA	0.083Ω	6.2GHz
LQW15AN12NG8Z□	—	12nH ±2%	100MHz	30	250MHz	1240mA	0.093Ω	5.2GHz
LQW15AN12NJ8Z□	—	12nH ±5%	100MHz	30	250MHz	1240mA	0.093Ω	5.2GHz
LQW15AN13NG8Z□	—	13nH ±2%	100MHz	30	250MHz	1240mA	0.093Ω	5.2GHz
LQW15AN13NJ8Z□	—	13nH ±5%	100MHz	30	250MHz	1240mA	0.093Ω	5.2GHz
LQW15AN14NG8Z□	—	14nH ±2%	100MHz	31	250MHz	1150mA	0.111Ω	5.2GHz
LQW15AN14NJ8Z□	—	14nH ±5%	100MHz	31	250MHz	1150mA	0.111Ω	5.2GHz
LQW15AN15NG8Z□	—	15nH ±2%	100MHz	31	250MHz	1150mA	0.114Ω	5.5GHz
LQW15AN15NJ8Z□	—	15nH ±5%	100MHz	31	250MHz	1150mA	0.114Ω	5.5GHz
LQW15AN16NG8Z□	—	16nH ±2%	100MHz	31	250MHz	1000mA	0.126Ω	5.0GHz
LQW15AN16NJ8Z□	—	16nH ±5%	100MHz	31	250MHz	1000mA	0.126Ω	5.0GHz
LQW15AN17NG8Z□	—	17nH ±2%	100MHz	30	250MHz	1000mA	0.126Ω	5.0GHz
LQW15AN17NJ8Z□	—	17nH ±5%	100MHz	30	250MHz	1000mA	0.126Ω	5.0GHz
LQW15AN18NG8Z□	—	18nH ±2%	100MHz	30	250MHz	1050mA	0.130Ω	5.2GHz
LQW15AN18NJ8Z□	—	18nH ±5%	100MHz	30	250MHz	1050mA	0.130Ω	5.2GHz
LQW15AN19NG8Z□	—	19nH ±2%	100MHz	30	250MHz	920mA	0.156Ω	5.0GHz
LQW15AN19NJ8Z□	—	19nH ±5%	100MHz	30	250MHz	920mA	0.156Ω	5.0GHz
LQW15AN20NG8Z□	—	20nH ±2%	100MHz	30	250MHz	800mA	0.186Ω	4.5GHz
LQW15AN20NJ8Z□	—	20nH ±5%	100MHz	30	250MHz	800mA	0.186Ω	4.5GHz
LQW15AN21NG8Z□	—	21nH ±2%	100MHz	30	250MHz	780mA	0.202Ω	4.5GHz
LQW15AN21NJ8Z□	—	21nH ±5%	100MHz	30	250MHz	780mA	0.202Ω	4.5GHz
LQW15AN22NG8Z□	—	22nH ±2%	100MHz	30	250MHz	780mA	0.202Ω	4.5GHz
LQW15AN22NJ8Z□	—	22nH ±5%	100MHz	30	250MHz	780mA	0.202Ω	4.5GHz
LQW15AN23NG8Z□	—	23nH ±2%	100MHz	29	250MHz	760mA	0.201Ω	4.5GHz
LQW15AN23NJ8Z□	—	23nH ±5%	100MHz	29	250MHz	760mA	0.201Ω	4.5GHz
LQW15AN24NG8Z□	—	24nH ±2%	100MHz	31	250MHz	770mA	0.212Ω	4.0GHz
LQW15AN24NJ8Z□	—	24nH ±5%	100MHz	31	250MHz	770mA	0.212Ω	4.0GHz
LQW15AN25NG8Z□	—	25nH ±2%	100MHz	31	250MHz	750mA	0.221Ω	4.1GHz
LQW15AN25NJ8Z□	—	25nH ±5%	100MHz	31	250MHz	750mA	0.221Ω	4.1GHz
LQW15AN26NG8Z□	—	26nH ±2%	100MHz	29	250MHz	720mA	0.282Ω	4.1GHz
LQW15AN26NJ8Z□	—	26nH ±5%	100MHz	29	250MHz	720mA	0.282Ω	4.1GHz
LQW15AN27NG8Z□	—	27nH ±2%	100MHz	30	250MHz	680mA	0.288Ω	4.0GHz
LQW15AN27NJ8Z□	—	27nH ±5%	100MHz	30	250MHz	680mA	0.288Ω	4.0GHz
LQW15AN30NG8Z□	—	30nH ±2%	100MHz	30	250MHz	660mA	0.309Ω	3.8GHz
LQW15AN30NJ8Z□	—	30nH ±5%	100MHz	30	250MHz	660mA	0.309Ω	3.8GHz
LQW15AN33NG8Z□	—	33nH ±2%	100MHz	30	250MHz	620mA	0.336Ω	3.6GHz
LQW15AN33NJ8Z□	—	33nH ±5%	100MHz	30	250MHz	620mA	0.336Ω	3.6GHz
LQW15AN36NG8Z□	—	36nH ±2%	100MHz	30	250MHz	540mA	0.431Ω	3.5GHz
LQW15AN36NJ8Z□	—	36nH ±5%	100MHz	30	250MHz	540mA	0.431Ω	3.5GHz
LQW15AN39NG8Z□	—	39nH ±2%	100MHz	28	250MHz	530mA	0.456Ω	3.4GHz
LQW15AN39NJ8Z□	—	39nH ±5%	100MHz	28	250MHz	530mA	0.456Ω	3.4GHz
LQW15AN43NG8Z□	—	43nH ±2%	100MHz	30	250MHz	515mA	0.516Ω	3.4GHz
LQW15AN43NJ8Z□	—	43nH ±5%	100MHz	30	250MHz	515mA	0.516Ω	3.4GHz
LQW15AN47NG8Z□	—	47nH ±2%	100MHz	25	200MHz	440mA	0.648Ω	3.2GHz
LQW15AN47NJ8Z□	—	47nH ±5%	100MHz	25	200MHz	440mA	0.648Ω	3.2GHz

Operating temp.range (Self-temp.rise not included): -55 to 125°C

Only for reflow soldering

\*S.R.F: Self Resonant Frequency

In operating temperatures exceeding +85°C, derating of current is necessary for the LQW15A\_80 series. Please apply the derating curve shown in the chart according to the operating temperature. Please consider "Notice (Rating)."

Continued on the following page. ↗



Continued from the preceding page. ↘

Part Number		Inductance	Inductance Test Frequency	Q (min.)	Q Test Frequency	Rated Current	Max. of DC Resistance	S.R.F* (min.)
Infotainment	Powertrain/Safety							
LQW15AN51NG8Z□	—	51nH ±2%	100MHz	25	200MHz	415mA	0.696Ω	2.9GHz
LQW15AN51NJ8Z□	—	51nH ±5%	100MHz	25	200MHz	415mA	0.696Ω	2.9GHz
LQW15AN53NG8Z□	—	53nH ±2%	100MHz	25	200MHz	415mA	0.696Ω	2.9GHz
LQW15AN53NJ8Z□	—	53nH ±5%	100MHz	25	200MHz	415mA	0.696Ω	2.9GHz
LQW15AN56NG8Z□	—	56nH ±2%	100MHz	25	200MHz	340mA	0.996Ω	2.9GHz
LQW15AN56NJ8Z□	—	56nH ±5%	100MHz	25	200MHz	340mA	0.996Ω	2.9GHz
LQW15AN68NG8Z□	—	68nH ±2%	100MHz	25	200MHz	320mA	1.128Ω	2.5GHz
LQW15AN68NJ8Z□	—	68nH ±5%	100MHz	25	200MHz	320mA	1.128Ω	2.5GHz
LQW15AN75NG8Z□	—	75nH ±2%	100MHz	25	200MHz	320mA	1.224Ω	2.4GHz
LQW15AN75NJ8Z□	—	75nH ±5%	100MHz	25	200MHz	320mA	1.224Ω	2.4GHz

Operating temp.range (Self-temp.rise not included): -55 to 125°C

Only for reflow soldering

\*S.R.F: Self Resonant Frequency

In operating temperatures exceeding +85°C, derating of current is necessary for the LQW15A\_80 series. Please apply the derating curve shown in the chart according to the operating temperature. Please consider "Notice (Rating)."

### Inductance-Frequency Characteristics (Typ.)

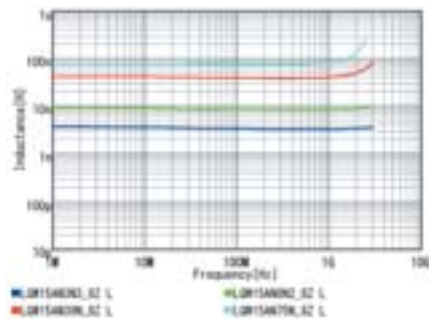

### Q-Frequency Characteristics (Typ.)

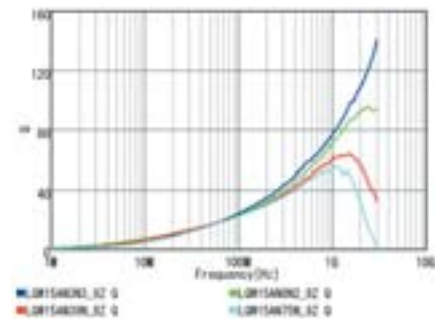

### Notice (Rating)

In operating temperatures exceeding +85°C, derating of current is necessary for this series.

Please apply the derating curve shown in the chart according to the operating temperature.

#### Derating of Rated Current

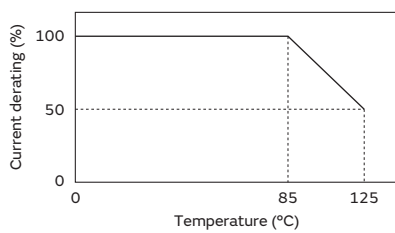

**RF Inductors**

# LQW18AN\_0Z Series 0603 (1608) inch (mm)

**Appearance/Dimensions**

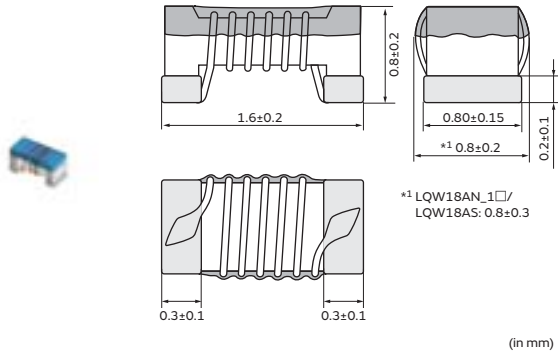

**Packaging**

Code	Packaging	Minimum Quantity
D	ø180mm Paper Taping	4000
J	ø330mm Paper Taping	10000
B	Packing in Bulk	500

**Rated Value (□: packaging code)**

Part Number		Inductance	Inductance Test Frequency	Q (min.)	Q Test Frequency	Rated Current	Max. of DC Resistance	S.R.F* (min.)
Infotainment	Powertrain/Safety							
LQW18AN2N2D0Z□	—	2.2nH ±0.5nH	100MHz	16	250MHz	700mA	0.042Ω	6000MHz
LQW18AN3N6C0Z□	—	3.6nH ±0.2nH	100MHz	25	250MHz	850mA	0.059Ω	6000MHz
LQW18AN3N6D0Z□	—	3.6nH ±0.5nH	100MHz	25	250MHz	850mA	0.059Ω	6000MHz
LQW18AN3N9C0Z□	—	3.9nH ±0.2nH	100MHz	35	250MHz	850mA	0.059Ω	6000MHz
LQW18AN3N9D0Z□	—	3.9nH ±0.5nH	100MHz	35	250MHz	850mA	0.059Ω	6000MHz
LQW18AN4N3C0Z□	—	4.3nH ±0.2nH	100MHz	35	250MHz	850mA	0.059Ω	6000MHz
LQW18AN4N3D0Z□	—	4.3nH ±0.5nH	100MHz	35	250MHz	850mA	0.059Ω	6000MHz
LQW18AN4N7D0Z□	—	4.7nH ±0.5nH	100MHz	35	250MHz	850mA	0.059Ω	6000MHz
LQW18AN5N6C0Z□	—	5.6nH ±0.2nH	100MHz	35	250MHz	750mA	0.082Ω	6000MHz
LQW18AN5N6D0Z□	—	5.6nH ±0.5nH	100MHz	35	250MHz	750mA	0.082Ω	6000MHz
LQW18AN6N2C0Z□	—	6.2nH ±0.2nH	100MHz	35	250MHz	750mA	0.082Ω	6000MHz
LQW18AN6N2D0Z□	—	6.2nH ±0.5nH	100MHz	35	250MHz	750mA	0.082Ω	6000MHz
LQW18AN6N8C0Z□	—	6.8nH ±0.2nH	100MHz	35	250MHz	750mA	0.082Ω	6000MHz
LQW18AN6N8D0Z□	—	6.8nH ±0.5nH	100MHz	35	250MHz	750mA	0.082Ω	6000MHz
LQW18AN7N5C0Z□	—	7.5nH ±0.2nH	100MHz	35	250MHz	750mA	0.082Ω	6000MHz
LQW18AN7N5D0Z□	—	7.5nH ±0.5nH	100MHz	35	250MHz	750mA	0.082Ω	6000MHz
LQW18AN8N2C0Z□	—	8.2nH ±0.2nH	100MHz	35	250MHz	650mA	0.11Ω	6000MHz
LQW18AN8N2D0Z□	—	8.2nH ±0.5nH	100MHz	35	250MHz	650mA	0.11Ω	6000MHz
LQW18AN8N7C0Z□	—	8.7nH ±0.2nH	100MHz	35	250MHz	650mA	0.11Ω	6000MHz
LQW18AN8N7D0Z□	—	8.7nH ±0.5nH	100MHz	35	250MHz	650mA	0.11Ω	6000MHz
LQW18AN9N1C0Z□	—	9.1nH ±0.2nH	100MHz	35	250MHz	650mA	0.11Ω	6000MHz
LQW18AN9N1D0Z□	—	9.1nH ±0.5nH	100MHz	35	250MHz	650mA	0.11Ω	6000MHz
LQW18AN9N5D0Z□	—	9.5nH ±0.5nH	100MHz	35	250MHz	650mA	0.11Ω	6000MHz
LQW18AN10NG0Z□	—	10nH ±2%	100MHz	35	250MHz	650mA	0.11Ω	6000MHz
LQW18AN10NJ0Z□	—	10nH ±5%	100MHz	35	250MHz	650mA	0.11Ω	6000MHz
LQW18AN11NG0Z□	—	11nH ±2%	100MHz	35	250MHz	650mA	0.11Ω	6000MHz
LQW18AN11NJ0Z□	—	11nH ±5%	100MHz	35	250MHz	650mA	0.11Ω	6000MHz
LQW18AN12NG0Z□	—	12nH ±2%	100MHz	35	250MHz	600mA	0.13Ω	6000MHz
LQW18AN12NJ0Z□	—	12nH ±5%	100MHz	35	250MHz	600mA	0.13Ω	6000MHz
LQW18AN13NG0Z□	—	13nH ±2%	100MHz	35	250MHz	600mA	0.13Ω	6000MHz
LQW18AN13NJ0Z□	—	13nH ±5%	100MHz	35	250MHz	600mA	0.13Ω	6000MHz
LQW18AN15NG0Z□	—	15nH ±2%	100MHz	40	250MHz	600mA	0.13Ω	6000MHz

Operating temp.range (Self-temp.rise not included): -55 to 125°C

Only for reflow soldering

\*S.R.F: Self Resonant Frequency

Continued on the following page. ↗

Continued from the preceding page. ↘

Part Number		Inductance	Inductance Test Frequency	Q (min.)	Q Test Frequency	Rated Current	Max. of DC Resistance	S.R.F* (min.)
Infotainment	Powertrain/Safety							
LQW18AN15NJ0Z□	—	15nH ±5%	100MHz	40	250MHz	600mA	0.13Ω	6000MHz
LQW18AN16NG0Z□	—	16nH ±2%	100MHz	40	250MHz	550mA	0.16Ω	5500MHz
LQW18AN16NJ0Z□	—	16nH ±5%	100MHz	40	250MHz	550mA	0.16Ω	5500MHz
LQW18AN18NG0Z□	—	18nH ±2%	100MHz	40	250MHz	550mA	0.16Ω	5500MHz
LQW18AN18NJ0Z□	—	18nH ±5%	100MHz	40	250MHz	550mA	0.16Ω	5500MHz
LQW18AN20NG0Z□	—	20nH ±2%	100MHz	40	250MHz	550mA	0.16Ω	4900MHz
LQW18AN20NJ0Z□	—	20nH ±5%	100MHz	40	250MHz	550mA	0.16Ω	4900MHz
LQW18AN22NG0Z□	—	22nH ±2%	100MHz	40	250MHz	500mA	0.17Ω	4600MHz
LQW18AN22NJ0Z□	—	22nH ±5%	100MHz	40	250MHz	500mA	0.17Ω	4600MHz
LQW18AN24NG0Z□	—	24nH ±2%	100MHz	40	250MHz	500mA	0.21Ω	3800MHz
LQW18AN24NJ0Z□	—	24nH ±5%	100MHz	40	250MHz	500mA	0.21Ω	3800MHz
LQW18AN27NG0Z□	—	27nH ±2%	100MHz	40	250MHz	440mA	0.21Ω	3700MHz
LQW18AN27NJ0Z□	—	27nH ±5%	100MHz	40	250MHz	440mA	0.21Ω	3700MHz
LQW18AN30NG0Z□	—	30nH ±2%	100MHz	40	250MHz	420mA	0.23Ω	3300MHz
LQW18AN30NJ0Z□	—	30nH ±5%	100MHz	40	250MHz	420mA	0.23Ω	3300MHz
LQW18AN33NG0Z□	—	33nH ±2%	100MHz	40	250MHz	420mA	0.23Ω	3200MHz
LQW18AN33NJ0Z□	—	33nH ±5%	100MHz	40	250MHz	420mA	0.23Ω	3200MHz
LQW18AN36NG0Z□	—	36nH ±2%	100MHz	40	250MHz	400mA	0.26Ω	2900MHz
LQW18AN36NJ0Z□	—	36nH ±5%	100MHz	40	250MHz	400mA	0.26Ω	2900MHz
LQW18AN39NG0Z□	—	39nH ±2%	100MHz	40	250MHz	400mA	0.26Ω	2800MHz
LQW18AN39NJ0Z□	—	39nH ±5%	100MHz	40	250MHz	400mA	0.26Ω	2800MHz
LQW18AN43NG0Z□	—	43nH ±2%	100MHz	40	200MHz	380mA	0.29Ω	2700MHz
LQW18AN43NJ0Z□	—	43nH ±5%	100MHz	40	200MHz	380mA	0.29Ω	2700MHz
LQW18AN47NG0Z□	—	47nH ±2%	100MHz	38	200MHz	380mA	0.29Ω	2600MHz
LQW18AN47NJ0Z□	—	47nH ±5%	100MHz	38	200MHz	380mA	0.29Ω	2600MHz
LQW18AN51NG0Z□	—	51nH ±2%	100MHz	38	200MHz	370mA	0.33Ω	2500MHz
LQW18AN51NJ0Z□	—	51nH ±5%	100MHz	38	200MHz	370mA	0.33Ω	2500MHz
LQW18AN56NG0Z□	—	56nH ±2%	100MHz	38	200MHz	360mA	0.35Ω	2400MHz
LQW18AN56NJ0Z□	—	56nH ±5%	100MHz	38	200MHz	360mA	0.35Ω	2400MHz
LQW18AN62NG0Z□	—	62nH ±2%	100MHz	38	200MHz	280mA	0.51Ω	2300MHz
LQW18AN62NJ0Z□	—	62nH ±5%	100MHz	38	200MHz	280mA	0.51Ω	2300MHz
LQW18AN68NG0Z□	—	68nH ±2%	100MHz	38	200MHz	340mA	0.38Ω	2200MHz
LQW18AN68NJ0Z□	—	68nH ±5%	100MHz	38	200MHz	340mA	0.38Ω	2200MHz
LQW18AN72NG0Z□	—	72nH ±2%	100MHz	34	150MHz	270mA	0.56Ω	2100MHz
LQW18AN72NJ0Z□	—	72nH ±5%	100MHz	34	150MHz	270mA	0.56Ω	2100MHz
LQW18AN75NG0Z□	—	75nH ±2%	100MHz	34	150MHz	270mA	0.56Ω	2050MHz
LQW18AN75NJ0Z□	—	75nH ±5%	100MHz	34	150MHz	270mA	0.56Ω	2050MHz
LQW18AN82NG0Z□	—	82nH ±2%	100MHz	34	150MHz	250mA	0.60Ω	2000MHz
LQW18AN82NJ0Z□	—	82nH ±5%	100MHz	34	150MHz	250mA	0.60Ω	2000MHz
LQW18AN91NG0Z□	—	91nH ±2%	100MHz	34	150MHz	230mA	0.64Ω	1900MHz
LQW18AN91NJ0Z□	—	91nH ±5%	100MHz	34	150MHz	230mA	0.64Ω	1900MHz
LQW18ANR10G0Z□	—	100nH ±2%	100MHz	34	150MHz	220mA	0.68Ω	1800MHz
LQW18ANR10J0Z□	—	100nH ±5%	100MHz	34	150MHz	220mA	0.68Ω	1800MHz
LQW18ANR11G0Z□	—	110nH ±2%	100MHz	32	150MHz	200mA	1.2Ω	1700MHz
LQW18ANR11J0Z□	—	110nH ±5%	100MHz	32	150MHz	200mA	1.2Ω	1700MHz
LQW18ANR12G0Z□	—	120nH ±2%	100MHz	32	150MHz	180mA	1.3Ω	1600MHz
LQW18ANR12J0Z□	—	120nH ±5%	100MHz	32	150MHz	180mA	1.3Ω	1600MHz
LQW18ANR13G0Z□	—	130nH ±2%	100MHz	32	150MHz	170mA	1.4Ω	1450MHz
LQW18ANR13J0Z□	—	130nH ±5%	100MHz	32	150MHz	170mA	1.4Ω	1450MHz
LQW18ANR15G0Z□	—	150nH ±2%	100MHz	32	150MHz	160mA	1.5Ω	1400MHz
LQW18ANR15J0Z□	—	150nH ±5%	100MHz	32	150MHz	160mA	1.5Ω	1400MHz
LQW18ANR16G0Z□	—	160nH ±2%	100MHz	32	150MHz	150mA	2.1Ω	1350MHz
LQW18ANR16J0Z□	—	160nH ±5%	100MHz	32	150MHz	150mA	2.1Ω	1350MHz

Operating temp.range (Self-temp.rise not included): -55 to 125°C

Only for reflow soldering

\*S.R.F: Self Resonant Frequency

Continued on the following page. ↗

Inductors for Power Lines

Inductors for General Circuits

RF Inductors

Continued from the preceding page. ↘

Part Number		Inductance	Inductance Test Frequency	Q (min.)	Q Test Frequency	Rated Current	Max. of DC Resistance	S.R.F* (min.)
Infotainment	Powertrain/Safety							
LQW18ANR18G0Z□	—	180nH ±2%	100MHz	25	100MHz	140mA	2.2Ω	1300MHz
LQW18ANR18J0Z□	—	180nH ±5%	100MHz	25	100MHz	140mA	2.2Ω	1300MHz
LQW18ANR20G0Z□	—	200nH ±2%	100MHz	25	100MHz	120mA	2.4Ω	1250MHz
LQW18ANR20J0Z□	—	200nH ±5%	100MHz	25	100MHz	120mA	2.4Ω	1250MHz
LQW18ANR22G0Z□	—	220nH ±2%	100MHz	25	100MHz	120mA	2.5Ω	1200MHz
LQW18ANR22J0Z□	—	220nH ±5%	100MHz	25	100MHz	120mA	2.5Ω	1200MHz
LQW18ANR27G0Z□	—	270nH ±2%	100MHz	30	100MHz	110mA	3.4Ω	960MHz
LQW18ANR27J0Z□	—	270nH ±5%	100MHz	30	100MHz	110mA	3.4Ω	960MHz
LQW18ANR33G0Z□	—	330nH ±2%	100MHz	30	100MHz	85mA	5.5Ω	800MHz
LQW18ANR33J0Z□	—	330nH ±5%	100MHz	30	100MHz	85mA	5.5Ω	800MHz
LQW18ANR39G0Z□	—	390nH ±2%	100MHz	30	100MHz	80mA	6.2Ω	800MHz
LQW18ANR39J0Z□	—	390nH ±5%	100MHz	30	100MHz	80mA	6.2Ω	800MHz
LQW18ANR47G0Z□	—	470nH ±2%	100MHz	30	100MHz	75mA	7.0Ω	700MHz
LQW18ANR47J0Z□	—	470nH ±5%	100MHz	30	100MHz	75mA	7.0Ω	700MHz

Operating temp.range (Self-temp.rise not included): -55 to 125°C

Only for reflow soldering

\*S.R.F: Self Resonant Frequency

### Inductance-Frequency Characteristics (Typ.)

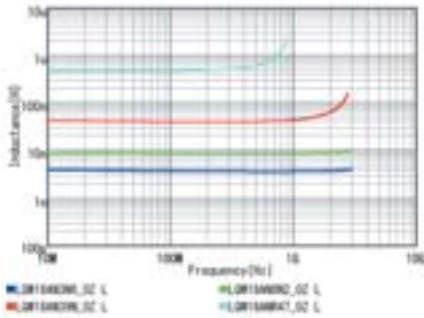

### Q-Frequency Characteristics (Typ.)

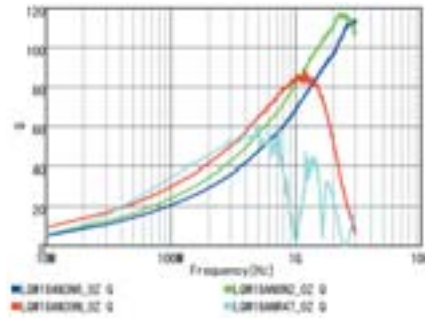

**RF Inductors**

# LQW18AN\_1Z Series 0603 (1608) inch (mm)

**Appearance/Dimensions**

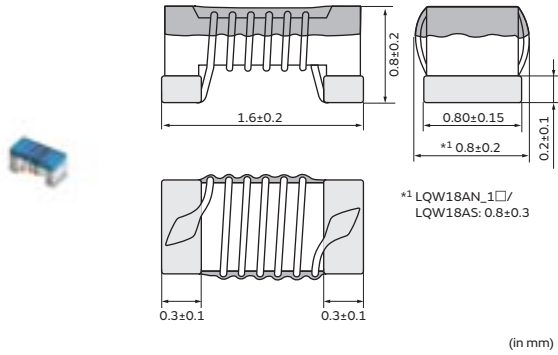

**Packaging**

Code	Packaging	Minimum Quantity
D	ø180mm Paper Taping	4000
J	ø330mm Paper Taping	10000
B	Packing in Bulk	500

**Rated Value (□: packaging code)**

Part Number		Inductance	Inductance Test Frequency	Q (min.)	Q Test Frequency	Rated Current	Max. of DC Resistance	S.R.F* (min.)
Infotainment	Powertrain/Safety							
LQW18AN2N2D1Z□	—	2.2nH ±0.5nH	100MHz	25	250MHz	1400mA	0.018Ω	1800MHz
LQW18AN3N9C1Z□	—	3.9nH ±0.2nH	100MHz	38	250MHz	1000mA	0.032Ω	1100MHz
LQW18AN3N9D1Z□	—	3.9nH ±0.5nH	100MHz	38	250MHz	1000mA	0.032Ω	1100MHz
LQW18AN5N6D1Z□	—	5.6nH ±0.5nH	100MHz	38	250MHz	900mA	0.045Ω	1000MHz
LQW18AN6N8C1Z□	—	6.8nH ±0.2nH	100MHz	38	250MHz	900mA	0.045Ω	7000MHz
LQW18AN6N8D1Z□	—	6.8nH ±0.5nH	100MHz	38	250MHz	900mA	0.045Ω	7000MHz
LQW18AN8N2D1Z□	—	8.2nH ±0.5nH	100MHz	38	250MHz	800mA	0.058Ω	7000MHz
LQW18AN10NG1Z□	—	10nH ±2%	100MHz	38	250MHz	800mA	0.058Ω	5000MHz
LQW18AN10NJ1Z□	—	10nH ±5%	100MHz	38	250MHz	800mA	0.058Ω	5000MHz
LQW18AN12NG1Z□	—	12nH ±2%	100MHz	38	250MHz	750mA	0.071Ω	5000MHz
LQW18AN12NJ1Z□	—	12nH ±5%	100MHz	38	250MHz	750mA	0.071Ω	5000MHz
LQW18AN15NJ1Z□	—	15nH ±5%	100MHz	42	250MHz	700mA	0.085Ω	4500MHz
LQW18AN18NG1Z□	—	18nH ±2%	100MHz	42	250MHz	700mA	0.085Ω	3500MHz
LQW18AN18NJ1Z□	—	18nH ±5%	100MHz	42	250MHz	700mA	0.085Ω	3500MHz
LQW18AN22NG1Z□	—	22nH ±2%	100MHz	42	250MHz	640mA	0.099Ω	3200MHz
LQW18AN22NJ1Z□	—	22nH ±5%	100MHz	42	250MHz	640mA	0.099Ω	3200MHz
LQW18AN27NG1Z□	—	27nH ±2%	100MHz	42	250MHz	590mA	0.116Ω	2800MHz
LQW18AN27NJ1Z□	—	27nH ±5%	100MHz	42	250MHz	590mA	0.116Ω	2800MHz
LQW18AN33NJ1Z□	—	33nH ±5%	100MHz	42	250MHz	550mA	0.132Ω	2500MHz

Operating temp.range (Self-temp.rise not included): -55 to 125°C

Only for reflow soldering

\*S.R.F: Self Resonant Frequency

**Inductance-Frequency Characteristics (Typ.)**

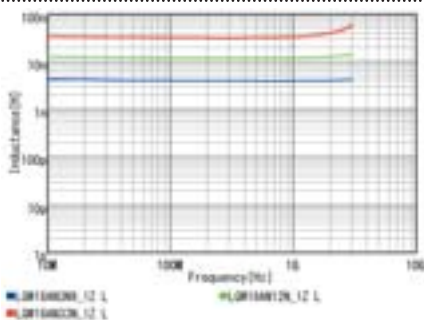

**Q-Frequency Characteristics (Typ.)**

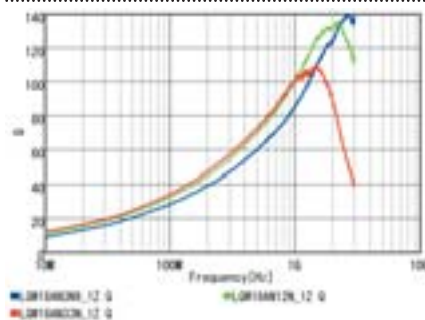

**RF Inductors**

# LQW18AN\_8Z Series 0603 (1608) inch (mm)

## Appearance/Dimensions

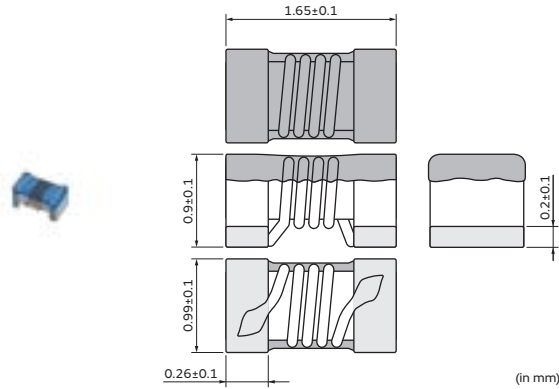

## Packaging

Code	Packaging	Minimum Quantity
D	ø180mm Paper Taping	4000
J	ø330mm Paper Taping	10000
B	Packing in Bulk	500

## Rated Value (□: packaging code)

Part Number		Inductance	Inductance Test Frequency	Q (min.)	Q Test Frequency	Rated Current	Max. of DC Resistance	S.R.F* (min.)
Infotainment	Powertrain/Safety							
LQW18AN2N2C8Z□	—	2.2nH ±0.2nH	100MHz	24	250MHz	3200mA	0.018Ω	15000MHz
LQW18AN2N4C8Z□	—	2.4nH ±0.2nH	100MHz	18	250MHz	2400mA	0.026Ω	15000MHz
LQW18AN3N0C8Z□	—	3.0nH ±0.2nH	100MHz	13	250MHz	670mA	0.170Ω	15000MHz
LQW18AN3N9B8Z□	—	3.9nH ±0.1nH	100MHz	30	250MHz	2200mA	0.028Ω	10000MHz
LQW18AN3N9C8Z□	—	3.9nH ±0.2nH	100MHz	30	250MHz	2200mA	0.028Ω	10000MHz
LQW18AN3N9G8Z□	—	3.9nH ±2%	100MHz	30	250MHz	2200mA	0.028Ω	10000MHz
LQW18AN4N1B8Z□	—	4.1nH ±0.1nH	100MHz	30	250MHz	2200mA	0.028Ω	10000MHz
LQW18AN4N1C8Z□	—	4.1nH ±0.2nH	100MHz	30	250MHz	2200mA	0.028Ω	10000MHz
LQW18AN4N1G8Z□	—	4.1nH ±2%	100MHz	30	250MHz	2200mA	0.028Ω	10000MHz
LQW18AN4N2B8Z□	—	4.2nH ±0.1nH	100MHz	30	250MHz	2200mA	0.028Ω	10000MHz
LQW18AN4N2C8Z□	—	4.2nH ±0.2nH	100MHz	30	250MHz	2200mA	0.028Ω	10000MHz
LQW18AN4N2G8Z□	—	4.2nH ±2%	100MHz	30	250MHz	2200mA	0.028Ω	10000MHz
LQW18AN4N3B8Z□	—	4.3nH ±0.1nH	100MHz	35	250MHz	2100mA	0.036Ω	11600MHz
LQW18AN4N3C8Z□	—	4.3nH ±0.2nH	100MHz	35	250MHz	2100mA	0.036Ω	11600MHz
LQW18AN4N3G8Z□	—	4.3nH ±2%	100MHz	35	250MHz	2100mA	0.036Ω	11600MHz
LQW18AN4N7B8Z□	—	4.7nH ±0.1nH	100MHz	25	250MHz	1500mA	0.054Ω	10400MHz
LQW18AN4N7C8Z□	—	4.7nH ±0.2nH	100MHz	25	250MHz	1500mA	0.054Ω	10400MHz
LQW18AN4N7G8Z□	—	4.7nH ±2%	100MHz	25	250MHz	1500mA	0.054Ω	10400MHz
LQW18AN4N9B8Z□	—	4.9nH ±0.1nH	100MHz	23	250MHz	1200mA	0.081Ω	7300MHz
LQW18AN4N9C8Z□	—	4.9nH ±0.2nH	100MHz	23	250MHz	1200mA	0.081Ω	7300MHz
LQW18AN4N9G8Z□	—	4.9nH ±2%	100MHz	23	250MHz	1200mA	0.081Ω	7300MHz
LQW18AN5N6C8Z□	—	5.6nH ±0.2nH	100MHz	38	250MHz	1900mA	0.040Ω	6650MHz
LQW18AN5N6G8Z□	—	5.6nH ±2%	100MHz	38	250MHz	1900mA	0.040Ω	6650MHz
LQW18AN6N0C8Z□	—	6.0nH ±0.2nH	100MHz	40	250MHz	1900mA	0.040Ω	6650MHz
LQW18AN6N0G8Z□	—	6.0nH ±2%	100MHz	40	250MHz	1900mA	0.040Ω	6650MHz
LQW18AN6N5C8Z□	—	6.5nH ±0.2nH	100MHz	40	250MHz	1900mA	0.040Ω	6650MHz
LQW18AN6N5G8Z□	—	6.5nH ±2%	100MHz	40	250MHz	1900mA	0.040Ω	6650MHz
LQW18AN6N8C8Z□	—	6.8nH ±0.2nH	100MHz	40	250MHz	1900mA	0.040Ω	6650MHz
LQW18AN6N8G8Z□	—	6.8nH ±2%	100MHz	40	250MHz	1900mA	0.040Ω	6650MHz
LQW18AN7N2C8Z□	—	7.2nH ±0.2nH	100MHz	38	250MHz	1900mA	0.040Ω	6650MHz
LQW18AN7N2G8Z□	—	7.2nH ±2%	100MHz	38	250MHz	1900mA	0.040Ω	6650MHz

Operating temp.range (Self-temp.rise not included): -55 to 125°C

Only for reflow soldering

\*S.R.F: Self Resonant Frequency

In operating temperatures exceeding +85°C, derating of current is necessary for this series. Please apply the derating curve shown in the chart according to the operating temperature. Please consider "Notice (Rating)." When rated current is applied to the products, the temperature rise caused by self-generated heat shall be limited to 40°C max.

Continued on the following page. ↗

Continued from the preceding page. ↘

Part Number		Inductance	Inductance Test Frequency	Q (min.)	Q Test Frequency	Rated Current	Max. of DC Resistance	S.R.F* (min.)
Infotainment	Powertrain/Safety							
LQW18AN7N5C8Z□	—	7.5nH ±0.2nH	100MHz	35	250MHz	1500mA	0.048Ω	7000MHz
LQW18AN7N5G8Z□	—	7.5nH ±2%	100MHz	35	250MHz	1500mA	0.048Ω	7000MHz
LQW18AN8N2C8Z□	—	8.2nH ±0.2nH	100MHz	38	250MHz	1600mA	0.052Ω	4750MHz
LQW18AN8N2G8Z□	—	8.2nH ±2%	100MHz	38	250MHz	1600mA	0.052Ω	4750MHz
LQW18AN8N4C8Z□	—	8.4nH ±0.2nH	100MHz	38	250MHz	1600mA	0.052Ω	4750MHz
LQW18AN8N4G8Z□	—	8.4nH ±2%	100MHz	38	250MHz	1600mA	0.052Ω	4750MHz
LQW18AN8N7C8Z□	—	8.7nH ±0.2nH	100MHz	38	250MHz	1600mA	0.052Ω	4750MHz
LQW18AN8N7G8Z□	—	8.7nH ±2%	100MHz	38	250MHz	1600mA	0.052Ω	4750MHz
LQW18AN9N1C8Z□	—	9.1nH ±0.2nH	100MHz	38	250MHz	1600mA	0.052Ω	4750MHz
LQW18AN9N1G8Z□	—	9.1nH ±2%	100MHz	38	250MHz	1600mA	0.052Ω	4750MHz
LQW18AN9N5C8Z□	—	9.5nH ±0.2nH	100MHz	38	250MHz	1600mA	0.052Ω	4750MHz
LQW18AN9N5G8Z□	—	9.5nH ±2%	100MHz	38	250MHz	1600mA	0.052Ω	4750MHz
LQW18AN9N9C8Z□	—	9.9nH ±0.2nH	100MHz	38	250MHz	1600mA	0.052Ω	4750MHz
LQW18AN9N9G8Z□	—	9.9nH ±2%	100MHz	38	250MHz	1600mA	0.052Ω	4750MHz
LQW18AN10NG8Z□	—	10nH ±2%	100MHz	38	250MHz	1600mA	0.052Ω	4750MHz
LQW18AN10NJ8Z□	—	10nH ±5%	100MHz	38	250MHz	1600mA	0.052Ω	4750MHz
LQW18AN11NG8Z□	—	11nH ±2%	100MHz	40	250MHz	1600mA	0.052Ω	4750MHz
LQW18AN11NJ8Z□	—	11nH ±5%	100MHz	40	250MHz	1600mA	0.052Ω	4750MHz
LQW18AN12NG8Z□	—	12nH ±2%	100MHz	37	250MHz	1500mA	0.064Ω	5000MHz
LQW18AN12NJ8Z□	—	12nH ±5%	100MHz	37	250MHz	1500mA	0.064Ω	5000MHz
LQW18AN13NG8Z□	—	13nH ±2%	100MHz	37	250MHz	1500mA	0.064Ω	5000MHz
LQW18AN13NJ8Z□	—	13nH ±5%	100MHz	37	250MHz	1500mA	0.064Ω	5000MHz
LQW18AN15NG8Z□	—	15nH ±2%	100MHz	38	250MHz	1400mA	0.075Ω	4600MHz
LQW18AN15NJ8Z□	—	15nH ±5%	100MHz	38	250MHz	1400mA	0.075Ω	4600MHz
LQW18AN16NG8Z□	—	16nH ±2%	100MHz	40	250MHz	1400mA	0.075Ω	4600MHz
LQW18AN16NJ8Z□	—	16nH ±5%	100MHz	40	250MHz	1400mA	0.075Ω	4600MHz
LQW18AN17NG8Z□	—	17nH ±2%	100MHz	40	250MHz	1400mA	0.075Ω	4600MHz
LQW18AN17NJ8Z□	—	17nH ±5%	100MHz	40	250MHz	1400mA	0.075Ω	4600MHz
LQW18AN18NG8Z□	—	18nH ±2%	100MHz	40	250MHz	1400mA	0.075Ω	4600MHz
LQW18AN18NJ8Z□	—	18nH ±5%	100MHz	40	250MHz	1400mA	0.075Ω	4600MHz
LQW18AN19NG8Z□	—	19nH ±2%	100MHz	40	250MHz	1400mA	0.075Ω	4600MHz
LQW18AN19NJ8Z□	—	19nH ±5%	100MHz	40	250MHz	1400mA	0.075Ω	4600MHz
LQW18AN22NG8Z□	—	22nH ±2%	100MHz	40	250MHz	1300mA	0.086Ω	3450MHz
LQW18AN22NJ8Z□	—	22nH ±5%	100MHz	40	250MHz	1300mA	0.086Ω	3450MHz
LQW18AN23NG8Z□	—	23nH ±2%	100MHz	40	250MHz	1300mA	0.086Ω	3450MHz
LQW18AN23NJ8Z□	—	23nH ±5%	100MHz	40	250MHz	1300mA	0.086Ω	3450MHz
LQW18AN24NG8Z□	—	24nH ±2%	100MHz	40	250MHz	1300mA	0.086Ω	3450MHz
LQW18AN24NJ8Z□	—	24nH ±5%	100MHz	40	250MHz	1300mA	0.086Ω	3450MHz
LQW18AN25NG8Z□	—	25nH ±2%	100MHz	40	250MHz	1200mA	0.098Ω	3600MHz
LQW18AN25NJ8Z□	—	25nH ±5%	100MHz	40	250MHz	1200mA	0.098Ω	3600MHz
LQW18AN27NG8Z□	—	27nH ±2%	100MHz	40	250MHz	1200mA	0.098Ω	3600MHz
LQW18AN27NJ8Z□	—	27nH ±5%	100MHz	40	250MHz	1200mA	0.098Ω	3600MHz
LQW18AN28NG8Z□	—	28nH ±2%	100MHz	40	250MHz	1200mA	0.098Ω	3600MHz
LQW18AN28NJ8Z□	—	28nH ±5%	100MHz	40	250MHz	1200mA	0.098Ω	3600MHz
LQW18AN30NG8Z□	—	30nH ±2%	100MHz	40	250MHz	1100mA	0.12Ω	2880MHz
LQW18AN30NJ8Z□	—	30nH ±5%	100MHz	40	250MHz	1100mA	0.12Ω	2880MHz
LQW18AN31NG8Z□	—	31nH ±2%	100MHz	40	250MHz	1100mA	0.11Ω	3150MHz
LQW18AN31NJ8Z□	—	31nH ±5%	100MHz	40	250MHz	1100mA	0.11Ω	3150MHz
LQW18AN33NG8Z□	—	33nH ±2%	100MHz	40	250MHz	1100mA	0.11Ω	3150MHz
LQW18AN33NJ8Z□	—	33nH ±5%	100MHz	40	250MHz	1100mA	0.11Ω	3150MHz
LQW18AN34NG8Z□	—	34nH ±2%	100MHz	40	250MHz	1050mA	0.15Ω	3000MHz
LQW18AN34NJ8Z□	—	34nH ±5%	100MHz	40	250MHz	1050mA	0.15Ω	3000MHz

Operating temp.range (Self-temp.rise not included): -55 to 125°C

Only for reflow soldering

\*S.R.F: Self Resonant Frequency

In operating temperatures exceeding +85°C, derating of current is necessary for this series. Please apply the derating curve shown in the chart according to the operating temperature. Please consider "Notice (Rating)." When rated current is applied to the products, the temperature rise caused by self-generated heat shall be limited to 40°C max.

Continued on the following page. ↗

Continued from the preceding page. ↘

Part Number		Inductance	Inductance Test Frequency	Q (min.)	Q Test Frequency	Rated Current	Max. of DC Resistance	S.R.F* (min.)
Infotainment	Powertrain/Safety							
LQW18AN36NG8Z□	—	36nH ±2%	100MHz	37	250MHz	910mA	0.20Ω	3000MHz
LQW18AN36NJ8Z□	—	36nH ±5%	100MHz	37	250MHz	910mA	0.20Ω	3000MHz
LQW18AN37NG8Z□	—	37nH ±2%	100MHz	37	250MHz	910mA	0.20Ω	3000MHz
LQW18AN37NJ8Z□	—	37nH ±5%	100MHz	37	250MHz	910mA	0.20Ω	3000MHz
LQW18AN39NG8Z□	—	39nH ±2%	100MHz	40	250MHz	1000mA	0.16Ω	3280MHz
LQW18AN39NJ8Z□	—	39nH ±5%	100MHz	40	250MHz	1000mA	0.16Ω	3280MHz
LQW18AN41NG8Z□	—	41nH ±2%	100MHz	40	250MHz	1000mA	0.16Ω	3280MHz
LQW18AN41NJ8Z□	—	41nH ±5%	100MHz	40	250MHz	1000mA	0.16Ω	3280MHz
LQW18AN43NG8Z□	—	43nH ±2%	100MHz	40	250MHz	840mA	0.21Ω	2780MHz
LQW18AN43NJ8Z□	—	43nH ±5%	100MHz	40	250MHz	840mA	0.21Ω	2780MHz
LQW18AN44NG8Z□	—	44nH ±2%	100MHz	40	250MHz	840mA	0.21Ω	2780MHz
LQW18AN44NJ8Z□	—	44nH ±5%	100MHz	40	250MHz	840mA	0.21Ω	2780MHz
LQW18AN47NG8Z□	—	47nH ±2%	100MHz	32	200MHz	830mA	0.23Ω	2700MHz
LQW18AN47NJ8Z□	—	47nH ±5%	100MHz	32	200MHz	830mA	0.23Ω	2700MHz
LQW18AN48NG8Z□	—	48nH ±2%	100MHz	32	200MHz	830mA	0.23Ω	2700MHz
LQW18AN48NJ8Z□	—	48nH ±5%	100MHz	32	200MHz	830mA	0.23Ω	2700MHz
LQW18AN51NG8Z□	—	51nH ±2%	100MHz	32	200MHz	830mA	0.23Ω	2700MHz
LQW18AN51NJ8Z□	—	51nH ±5%	100MHz	32	200MHz	830mA	0.23Ω	2700MHz
LQW18AN52NG8Z□	—	52nH ±2%	100MHz	35	200MHz	750mA	0.27Ω	2750MHz
LQW18AN52NJ8Z□	—	52nH ±5%	100MHz	35	200MHz	750mA	0.27Ω	2750MHz
LQW18AN56NG8Z□	—	56nH ±2%	100MHz	38	200MHz	770mA	0.26Ω	2600MHz
LQW18AN56NJ8Z□	—	56nH ±5%	100MHz	38	200MHz	770mA	0.26Ω	2600MHz
LQW18AN58NG8Z□	—	58nH ±2%	100MHz	35	200MHz	700mA	0.30Ω	2400MHz
LQW18AN58NJ8Z□	—	58nH ±5%	100MHz	35	200MHz	700mA	0.30Ω	2400MHz
LQW18AN68NG8Z□	—	68nH ±2%	100MHz	37	200MHz	630mA	0.38Ω	2380MHz
LQW18AN68NJ8Z□	—	68nH ±5%	100MHz	37	200MHz	630mA	0.38Ω	2380MHz
LQW18AN69NG8Z□	—	69nH ±2%	100MHz	37	200MHz	630mA	0.38Ω	2380MHz
LQW18AN69NJ8Z□	—	69nH ±5%	100MHz	37	200MHz	630mA	0.38Ω	2380MHz
LQW18AN72NG8Z□	—	72nH ±2%	100MHz	34	150MHz	560mA	0.47Ω	2330MHz
LQW18AN72NJ8Z□	—	72nH ±5%	100MHz	34	150MHz	560mA	0.47Ω	2330MHz
LQW18AN73NG8Z□	—	73nH ±2%	100MHz	28	150MHz	590mA	0.41Ω	2280MHz
LQW18AN73NJ8Z□	—	73nH ±5%	100MHz	28	150MHz	590mA	0.41Ω	2280MHz
LQW18AN75NG8Z□	—	75nH ±2%	100MHz	28	150MHz	590mA	0.41Ω	2280MHz
LQW18AN75NJ8Z□	—	75nH ±5%	100MHz	28	150MHz	590mA	0.41Ω	2280MHz
LQW18AN78NG8Z□	—	78nH ±2%	100MHz	28	150MHz	590mA	0.41Ω	2280MHz
LQW18AN78NJ8Z□	—	78nH ±5%	100MHz	28	150MHz	590mA	0.41Ω	2280MHz
LQW18AN82NG8Z□	—	82nH ±2%	100MHz	34	150MHz	550mA	0.50Ω	2230MHz
LQW18AN82NJ8Z□	—	82nH ±5%	100MHz	34	150MHz	550mA	0.50Ω	2230MHz
LQW18AN83NG8Z□	—	83nH ±2%	100MHz	34	150MHz	550mA	0.50Ω	2230MHz
LQW18AN83NJ8Z□	—	83nH ±5%	100MHz	34	150MHz	550mA	0.50Ω	2230MHz
LQW18AN91NG8Z□	—	91nH ±2%	100MHz	33	150MHz	520mA	0.54Ω	1900MHz
LQW18AN91NJ8Z□	—	91nH ±5%	100MHz	33	150MHz	520mA	0.54Ω	1900MHz
LQW18AN94NG8Z□	—	94nH ±2%	100MHz	34	150MHz	490mA	0.63Ω	1750MHz
LQW18AN94NJ8Z□	—	94nH ±5%	100MHz	34	150MHz	490mA	0.63Ω	1750MHz
LQW18ANR10G8Z□	—	100nH ±2%	100MHz	34	150MHz	490mA	0.63Ω	1750MHz
LQW18ANR10J8Z□	—	100nH ±5%	100MHz	34	150MHz	490mA	0.63Ω	1750MHz
LQW18ANR11G8Z□	—	110nH ±2%	100MHz	32	150MHz	450mA	0.70Ω	1730MHz
LQW18ANR11J8Z□	—	110nH ±5%	100MHz	32	150MHz	450mA	0.70Ω	1730MHz
LQW18ANR12G8Z□	—	120nH ±2%	100MHz	32	150MHz	450mA	0.72Ω	1650MHz
LQW18ANR12J8Z□	—	120nH ±5%	100MHz	32	150MHz	450mA	0.72Ω	1650MHz
LQW18ANR15G8Z□	—	150nH ±2%	100MHz	28	150MHz	420mA	0.87Ω	1580MHz
LQW18ANR15J8Z□	—	150nH ±5%	100MHz	28	150MHz	420mA	0.87Ω	1580MHz

Operating temp.range (Self-temp.rise not included): -55 to 125°C

Only for reflow soldering

\*S.R.F: Self Resonant Frequency

In operating temperatures exceeding +85°C, derating of current is necessary for this series. Please apply the derating curve shown in the chart according to the operating temperature. Please consider "Notice (Rating)." When rated current is applied to the products, the temperature rise caused by self-generated heat shall be limited to 40°C max.

Inductors for Power Lines

Inductors for General Circuits

RF Inductors



Continued from the preceding page. ↘

Part Number		Inductance	Inductance Test Frequency	Q (min.)	Q Test Frequency	Rated Current	Max. of DC Resistance	S.R.F* (min.)
Infotainment	Powertrain/Safety							
LQW18ANR18G8Z□	—	180nH ±2%	100MHz	25	100MHz	310mA	1.65Ω	1380MHz
LQW18ANR18J8Z□	—	180nH ±5%	100MHz	25	100MHz	310mA	1.65Ω	1380MHz
LQW18ANR20G8Z□	—	200nH ±2%	100MHz	25	100MHz	290mA	1.74Ω	1350MHz
LQW18ANR20J8Z□	—	200nH ±5%	100MHz	25	100MHz	290mA	1.74Ω	1350MHz
LQW18ANR21G8Z□	—	210nH ±2%	100MHz	27	100MHz	280mA	1.98Ω	1330MHz
LQW18ANR21J8Z□	—	210nH ±5%	100MHz	27	100MHz	280mA	1.98Ω	1330MHz
LQW18ANR22G8Z□	—	220nH ±2%	100MHz	25	100MHz	280mA	2.08Ω	1330MHz
LQW18ANR22J8Z□	—	220nH ±5%	100MHz	25	100MHz	280mA	2.08Ω	1330MHz
LQW18ANR25G8Z□	—	250nH ±2%	100MHz	24	100MHz	250mA	2.28Ω	1330MHz
LQW18ANR25J8Z□	—	250nH ±5%	100MHz	24	100MHz	250mA	2.28Ω	1330MHz
LQW18ANR27G8Z□	—	270nH ±2%	100MHz	24	100MHz	260mA	2.42Ω	1250MHz
LQW18ANR27J8Z□	—	270nH ±5%	100MHz	24	100MHz	260mA	2.42Ω	1250MHz
LQW18ANR30G8Z□	—	300nH ±2%	100MHz	25	100MHz	220mA	3.12Ω	1200MHz
LQW18ANR30J8Z□	—	300nH ±5%	100MHz	25	100MHz	220mA	3.12Ω	1200MHz
LQW18ANR33G8Z□	—	330nH ±2%	100MHz	25	100MHz	190mA	3.84Ω	1100MHz
LQW18ANR33J8Z□	—	330nH ±5%	100MHz	25	100MHz	190mA	3.84Ω	1100MHz
LQW18ANR36G8Z□	—	360nH ±2%	100MHz	25	100MHz	190mA	3.98Ω	1050MHz
LQW18ANR36J8Z□	—	360nH ±5%	100MHz	25	100MHz	190mA	3.98Ω	1050MHz
LQW18ANR39G8Z□	—	390nH ±2%	100MHz	25	100MHz	190mA	4.23Ω	1100MHz
LQW18ANR39J8Z□	—	390nH ±5%	100MHz	25	100MHz	190mA	4.23Ω	1100MHz

Operating temp.range (Self-temp.rise not included): -55 to 125°C

Only for reflow soldering

\*S.R.F: Self Resonant Frequency

In operating temperatures exceeding +85°C, derating of current is necessary for this series. Please apply the derating curve shown in the chart according to the operating temperature. Please consider "Notice (Rating)." When rated current is applied to the products, the temperature rise caused by self-generated heat shall be limited to 40°C max.

**Inductance-Frequency Characteristics (Typ.)**

**Q-Frequency Characteristics (Typ.)**

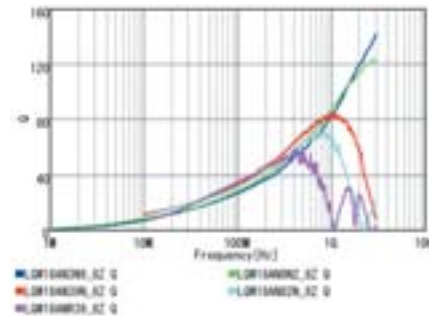
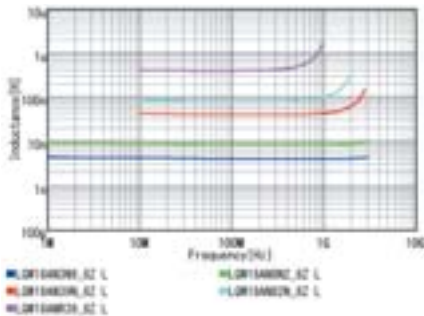

**Notice (Rating)**

In operating temperatures exceeding +85°C, derating of current is necessary for this series.

Please apply the derating curve shown in the chart according to the operating temperature.

**Derating of Rated Current**

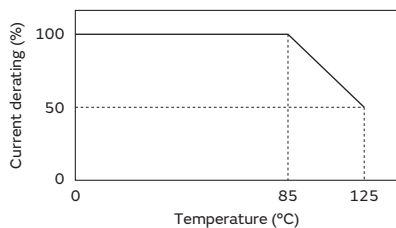

## RF Inductors

# LQW18AS\_0Z Series 0603 (1608) inch (mm)

### Appearance/Dimensions

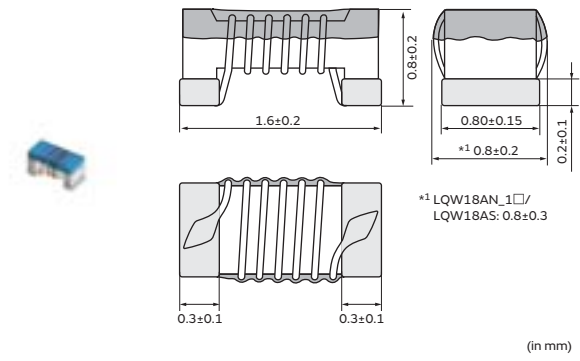

### Packaging

Code	Packaging	Minimum Quantity
D	ø180mm Paper Taping	4000
J	ø330mm Paper Taping	10000
B	Packing in Bulk	500

### Rated Value (□: packaging code)

Part Number		Inductance	Inductance Test Frequency	Q (min.)	Q Test Frequency	Rated Current	Max. of DC Resistance	S.R.F* (min.)
Infotainment	Powertrain/Safety							
LQW18AS1N6J0Z□	—	1.6nH ±5%	250MHz	24	250MHz	700mA	0.030Ω	12500MHz
LQW18AS1N8J0Z□	—	1.8nH ±5%	250MHz	16	250MHz	700mA	0.045Ω	12500MHz
LQW18AS3N3G0Z□	—	3.3nH ±2%	250MHz	35	250MHz	700mA	0.045Ω	5900MHz
LQW18AS3N3J0Z□	—	3.3nH ±5%	250MHz	35	250MHz	700mA	0.045Ω	5900MHz
LQW18AS3N6G0Z□	—	3.6nH ±2%	250MHz	22	250MHz	700mA	0.063Ω	5900MHz
LQW18AS3N6J0Z□	—	3.6nH ±5%	250MHz	22	250MHz	700mA	0.063Ω	5900MHz
LQW18AS3N9G0Z□	—	3.9nH ±2%	250MHz	22	250MHz	700mA	0.080Ω	6900MHz
LQW18AS3N9J0Z□	—	3.9nH ±5%	250MHz	22	250MHz	700mA	0.080Ω	6900MHz
LQW18AS4N3G0Z□	—	4.3nH ±2%	250MHz	22	250MHz	700mA	0.063Ω	5900MHz
LQW18AS4N3J0Z□	—	4.3nH ±5%	250MHz	22	250MHz	700mA	0.063Ω	5900MHz
LQW18AS4N7G0Z□	—	4.7nH ±2%	250MHz	20	250MHz	700mA	0.116Ω	5800MHz
LQW18AS4N7J0Z□	—	4.7nH ±5%	250MHz	20	250MHz	700mA	0.116Ω	5800MHz
LQW18AS5N1G0Z□	—	5.1nH ±2%	250MHz	20	250MHz	700mA	0.140Ω	5700MHz
LQW18AS5N1J0Z□	—	5.1nH ±5%	250MHz	20	250MHz	700mA	0.140Ω	5700MHz
LQW18AS5N6G0Z□	—	5.6nH ±2%	250MHz	26	250MHz	700mA	0.075Ω	4760MHz
LQW18AS5N6J0Z□	—	5.6nH ±5%	250MHz	26	250MHz	700mA	0.075Ω	4760MHz
LQW18AS6N8G0Z□	—	6.8nH ±2%	250MHz	27	250MHz	700mA	0.110Ω	5800MHz
LQW18AS6N8J0Z□	—	6.8nH ±5%	250MHz	27	250MHz	700mA	0.110Ω	5800MHz
LQW18AS7N5G0Z□	—	7.5nH ±2%	250MHz	28	250MHz	700mA	0.106Ω	4800MHz
LQW18AS7N5J0Z□	—	7.5nH ±5%	250MHz	28	250MHz	700mA	0.106Ω	4800MHz
LQW18AS8N2G0Z□	—	8.2nH ±2%	250MHz	30	250MHz	700mA	0.115Ω	4200MHz
LQW18AS8N2J0Z□	—	8.2nH ±5%	250MHz	30	250MHz	700mA	0.115Ω	4200MHz
LQW18AS8N7G0Z□	—	8.7nH ±2%	250MHz	28	250MHz	700mA	0.109Ω	4600MHz
LQW18AS8N7J0Z□	—	8.7nH ±5%	250MHz	28	250MHz	700mA	0.109Ω	4600MHz
LQW18AS9N5G0Z□	—	9.5nH ±2%	250MHz	28	250MHz	700mA	0.135Ω	5400MHz
LQW18AS9N5J0Z□	—	9.5nH ±5%	250MHz	28	250MHz	700mA	0.135Ω	5400MHz
LQW18AS10NG0Z□	—	10nH ±2%	250MHz	31	250MHz	700mA	0.130Ω	4800MHz
LQW18AS10NJ0Z□	—	10nH ±5%	250MHz	31	250MHz	700mA	0.130Ω	4800MHz
LQW18AS11NG0Z□	—	11nH ±2%	250MHz	30	250MHz	700mA	0.086Ω	4000MHz
LQW18AS11NJ0Z□	—	11nH ±5%	250MHz	30	250MHz	700mA	0.086Ω	4000MHz
LQW18AS12NG0Z□	—	12nH ±2%	250MHz	35	250MHz	700mA	0.130Ω	4000MHz
LQW18AS12NJ0Z□	—	12nH ±5%	250MHz	35	250MHz	700mA	0.130Ω	4000MHz

Operating temp.range (Self-temp.rise included): -40 to 125°C

Only for reflow soldering

\*S.R.F: Self Resonant Frequency

Continued on the following page. ↗

Continued from the preceding page. ↘

Part Number		Inductance	Inductance Test Frequency	Q (min.)	Q Test Frequency	Rated Current	Max. of DC Resistance	S.R.F* (min.)
Infotainment	Powertrain/Safety							
LQW18AS15NG0Z□	—	15nH ±2%	250MHz	35	250MHz	700mA	0.170Ω	4000MHz
LQW18AS15NJ0Z□	—	15nH ±5%	250MHz	35	250MHz	700mA	0.170Ω	4000MHz
LQW18AS16NG0Z□	—	16nH ±2%	250MHz	34	250MHz	700mA	0.104Ω	3300MHz
LQW18AS16NJ0Z□	—	16nH ±5%	250MHz	34	250MHz	700mA	0.104Ω	3300MHz
LQW18AS18NG0Z□	—	18nH ±2%	250MHz	35	250MHz	700mA	0.170Ω	3100MHz
LQW18AS18NJ0Z□	—	18nH ±5%	250MHz	35	250MHz	700mA	0.170Ω	3100MHz
LQW18AS22NG0Z□	—	22nH ±2%	250MHz	38	250MHz	700mA	0.190Ω	3000MHz
LQW18AS22NJ0Z□	—	22nH ±5%	250MHz	38	250MHz	700mA	0.190Ω	3000MHz
LQW18AS23NG0Z□	—	23nH ±2%	250MHz	38	250MHz	700mA	0.190Ω	2850MHz
LQW18AS23NJ0Z□	—	23nH ±5%	250MHz	38	250MHz	700mA	0.190Ω	2850MHz
LQW18AS24NG0Z□	—	24nH ±2%	250MHz	36	250MHz	700mA	0.135Ω	2650MHz
LQW18AS24NJ0Z□	—	24nH ±5%	250MHz	36	250MHz	700mA	0.135Ω	2650MHz
LQW18AS27NG0Z□	—	27nH ±2%	250MHz	40	250MHz	600mA	0.220Ω	2800MHz
LQW18AS27NJ0Z□	—	27nH ±5%	250MHz	40	250MHz	600mA	0.220Ω	2800MHz
LQW18AS30NG0Z□	—	30nH ±2%	250MHz	37	250MHz	600mA	0.144Ω	2250MHz
LQW18AS30NJ0Z□	—	30nH ±5%	250MHz	37	250MHz	600mA	0.144Ω	2250MHz
LQW18AS33NG0Z□	—	33nH ±2%	250MHz	40	250MHz	600mA	0.220Ω	2300MHz
LQW18AS33NJ0Z□	—	33nH ±5%	250MHz	40	250MHz	600mA	0.220Ω	2300MHz
LQW18AS36NG0Z□	—	36nH ±2%	250MHz	37	250MHz	600mA	0.250Ω	2080MHz
LQW18AS36NJ0Z□	—	36nH ±5%	250MHz	37	250MHz	600mA	0.250Ω	2080MHz
LQW18AS39NG0Z□	—	39nH ±2%	250MHz	40	250MHz	600mA	0.250Ω	2200MHz
LQW18AS39NJ0Z□	—	39nH ±5%	250MHz	40	250MHz	600mA	0.250Ω	2200MHz
LQW18AS43NG0Z□	—	43nH ±2%	250MHz	38	250MHz	600mA	0.280Ω	2000MHz
LQW18AS43NJ0Z□	—	43nH ±5%	250MHz	38	250MHz	600mA	0.280Ω	2000MHz
LQW18AS47NG0Z□	—	47nH ±2%	200MHz	38	200MHz	600mA	0.280Ω	2000MHz
LQW18AS47NJ0Z□	—	47nH ±5%	200MHz	38	200MHz	600mA	0.280Ω	2000MHz
LQW18AS51NG0Z□	—	51nH ±2%	200MHz	35	200MHz	600mA	0.270Ω	1900MHz
LQW18AS51NJ0Z□	—	51nH ±5%	200MHz	35	200MHz	600mA	0.270Ω	1900MHz
LQW18AS56NG0Z□	—	56nH ±2%	200MHz	38	200MHz	600mA	0.310Ω	1900MHz
LQW18AS56NJ0Z□	—	56nH ±5%	200MHz	38	200MHz	600mA	0.310Ω	1900MHz
LQW18AS68NG0Z□	—	68nH ±2%	200MHz	37	200MHz	600mA	0.340Ω	1700MHz
LQW18AS68NJ0Z□	—	68nH ±5%	200MHz	37	200MHz	600mA	0.340Ω	1700MHz
LQW18AS72NG0Z□	—	72nH ±2%	150MHz	34	150MHz	400mA	0.490Ω	1700MHz
LQW18AS72NJ0Z□	—	72nH ±5%	150MHz	34	150MHz	400mA	0.490Ω	1700MHz
LQW18AS82NG0Z□	—	82nH ±2%	150MHz	34	150MHz	400mA	0.540Ω	1700MHz
LQW18AS82NJ0Z□	—	82nH ±5%	150MHz	34	150MHz	400mA	0.540Ω	1700MHz
LQW18ASR10G0Z□	—	100nH ±2%	150MHz	34	150MHz	400mA	0.580Ω	1400MHz
LQW18ASR10J0Z□	—	100nH ±5%	150MHz	34	150MHz	400mA	0.580Ω	1400MHz
LQW18ASR11G0Z□	—	110nH ±2%	150MHz	32	150MHz	300mA	0.610Ω	1350MHz
LQW18ASR11J0Z□	—	110nH ±5%	150MHz	32	150MHz	300mA	0.610Ω	1350MHz
LQW18ASR12G0Z□	—	120nH ±2%	150MHz	32	150MHz	300mA	0.650Ω	1300MHz
LQW18ASR12J0Z□	—	120nH ±5%	150MHz	32	150MHz	300mA	0.650Ω	1300MHz
LQW18ASR15G0Z□	—	150nH ±2%	150MHz	28	150MHz	280mA	0.920Ω	990MHz
LQW18ASR15J0Z□	—	150nH ±5%	150MHz	28	150MHz	280mA	0.920Ω	990MHz
LQW18ASR18G0Z□	—	180nH ±2%	100MHz	25	100MHz	240mA	1.250Ω	990MHz
LQW18ASR18J0Z□	—	180nH ±5%	100MHz	25	100MHz	240mA	1.250Ω	990MHz
LQW18ASR20G0Z□	—	200nH ±2%	100MHz	25	100MHz	200mA	1.980Ω	900MHz
LQW18ASR20J0Z□	—	200nH ±5%	100MHz	25	100MHz	200mA	1.980Ω	900MHz
LQW18ASR21G0Z□	—	210nH ±2%	100MHz	27	100MHz	200mA	2.060Ω	895MHz
LQW18ASR21J0Z□	—	210nH ±5%	100MHz	27	100MHz	200mA	2.060Ω	895MHz
LQW18ASR22G0Z□	—	220nH ±2%	100MHz	25	100MHz	200mA	2.100Ω	900MHz
LQW18ASR22J0Z□	—	220nH ±5%	100MHz	25	100MHz	200mA	2.100Ω	900MHz
LQW18ASR25G0Z□	—	250nH ±2%	100MHz	25	100MHz	120mA	3.550Ω	822MHz

Operating temp.range (Self-temp.rise included): -40 to 125°C  
 Only for reflow soldering  
 \*S.R.F: Self Resonant Frequency

Continued on the following page. ↗

Inductors for Power Lines

Inductors for General Circuits

RF Inductors

Continued from the preceding page. ↘

Part Number		Inductance	Inductance Test Frequency	Q (min.)	Q Test Frequency	Rated Current	Max. of DC Resistance	S.R.F* (min.)
Infotainment	Powertrain/Safety							
LQW18ASR25J0Z□	—	250nH ±5%	100MHz	25	100MHz	120mA	3.550Ω	822MHz
LQW18ASR27G0Z□	—	270nH ±2%	100MHz	24	100MHz	170mA	2.300Ω	900MHz
LQW18ASR27J0Z□	—	270nH ±5%	100MHz	24	100MHz	170mA	2.300Ω	900MHz
LQW18ASR33G0Z□	—	330nH ±2%	100MHz	25	100MHz	100mA	3.890Ω	900MHz
LQW18ASR33J0Z□	—	330nH ±5%	100MHz	25	100MHz	100mA	3.890Ω	900MHz
LQW18ASR39G0Z□	—	390nH ±2%	100MHz	25	100MHz	100mA	4.350Ω	900MHz
LQW18ASR39J0Z□	—	390nH ±5%	100MHz	25	100MHz	100mA	4.350Ω	900MHz

Operating temp.range (Self-temp.rise included): -40 to 125°C

Only for reflow soldering

\*S.R.F: Self Resonant Frequency

### Inductance-Frequency Characteristics (Typ.)

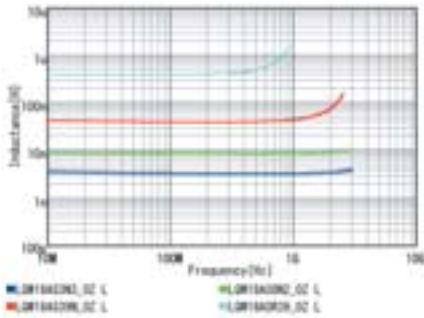

### Q-Frequency Characteristics (Typ.)

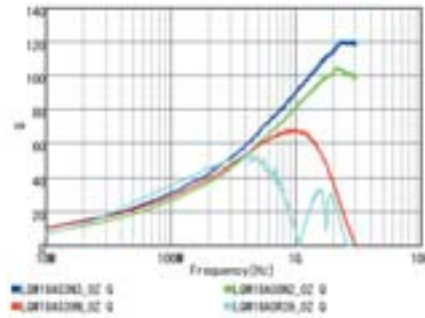

**RF Inductors**

# LQW15CN\_0Z Series 0402 (1005) inch (mm)

**Appearance/Dimensions**

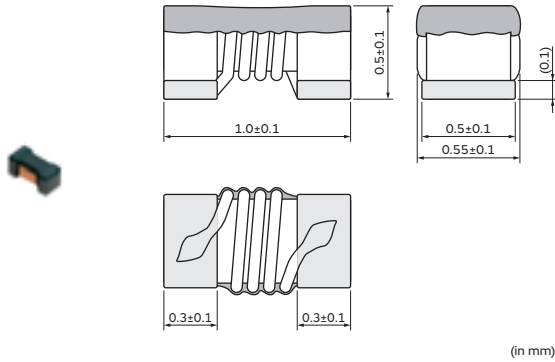

**Packaging**

Code	Packaging	Minimum Quantity
D	ø180mm Paper Taping	10000
B	Packing in Bulk	500

**Rated Value (□: packaging code)**

Part Number		Inductance	Inductance Test Frequency	Rated Current	Max. of DC Resistance	S.R.F* (min.)
Infotainment	Powertrain/Safety					
LQW15CN18NJ0Z□	—	18nH ±5%	100MHz	1400mA	0.046Ω	3000MHz
LQW15CN33NJ0Z□	—	33nH ±5%	100MHz	1300mA	0.065Ω	1800MHz
LQW15CN48NJ0Z□	—	48nH ±5%	100MHz	1100mA	0.078Ω	1400MHz
LQW15CN70NJ0Z□	—	70nH ±5%	100MHz	820mA	0.12Ω	1300MHz
LQW15CN96NJ0Z□	—	96nH ±5%	100MHz	730mA	0.16Ω	1100MHz
LQW15CNR13J0Z□	—	130nH ±5%	100MHz	640mA	0.23Ω	1000MHz
LQW15CNR16J0Z□	—	160nH ±5%	100MHz	480mA	0.33Ω	900MHz
LQW15CNR20J0Z□	—	200nH ±5%	100MHz	390mA	0.47Ω	800MHz

Operating temp.range (Self-temp.rise not included): -40 to 125°C

Class of Magnetic Shield: No Shield

Only for reflow soldering

\*S.R.F: Self Resonant Frequency

In operating temperatures exceeding +85°C, derating of current is necessary for the LQW15C series. Please apply the derating curve shown in the chart according to the operating temperature. Please consider "Notice (Rating)."

**Inductance-Frequency Characteristics (Typ.)**

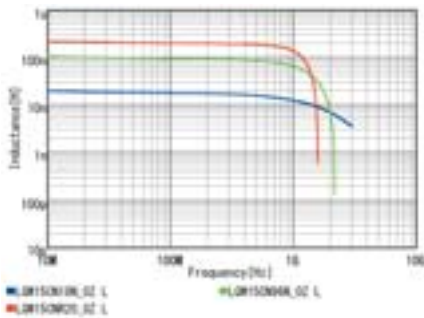

**Q-Frequency Characteristics (Typ.)**

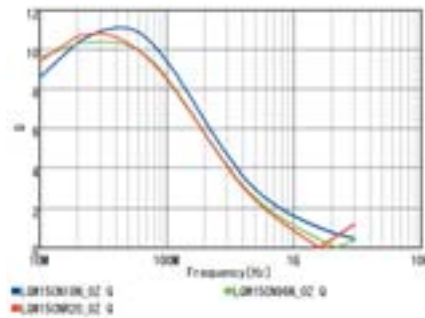

Continued on the following page. ↗

Continued from the preceding page. ↘

### Notice (Rating)

In operating temperatures exceeding +85°C, derating of current is necessary for this series.

Please apply the derating curve shown in the chart according to the operating temperature.

#### Derating of Rated Current

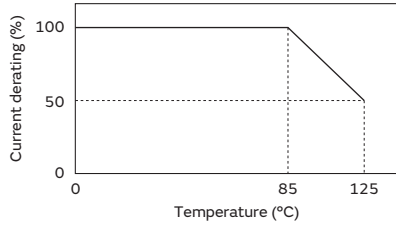

**RF Inductors**

# LQW15CN\_1Z Series 0402 (1005) inch (mm)

**Appearance/Dimensions**

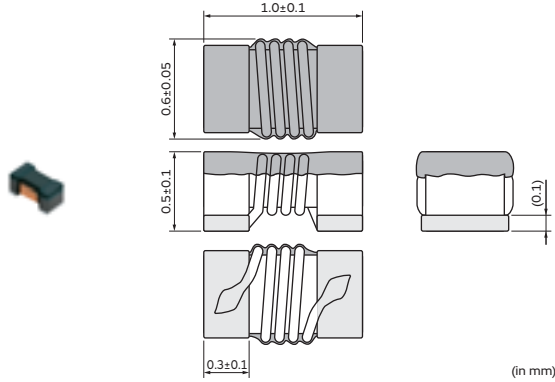

**Packaging**

Code	Packaging	Minimum Quantity
D	ø180mm Paper Taping	10000
B	Packing in Bulk	500

**Rated Value (□: packaging code)**

Part Number		Inductance	Inductance Test Frequency	Rated Current	Max. of DC Resistance	S.R.F* (min.)
Infotainment	Powertrain/Safety					
LQW15CN20NJ1Z□	—	20nH ±5%	100MHz	2200mA	0.028Ω	3000MHz
LQW15CN20NK1Z□	—	20nH ±10%	100MHz	2200mA	0.028Ω	3000MHz
LQW15CN34NJ1Z□	—	34nH ±5%	100MHz	1800mA	0.036Ω	2500MHz
LQW15CN34NK1Z□	—	34nH ±10%	100MHz	1800mA	0.036Ω	2500MHz
LQW15CN53NJ1Z□	—	53nH ±5%	100MHz	1300mA	0.060Ω	2000MHz
LQW15CN53NK1Z□	—	53nH ±10%	100MHz	1300mA	0.060Ω	2000MHz
LQW15CN77NJ1Z□	—	77nH ±5%	100MHz	1100mA	0.090Ω	2000MHz
LQW15CN77NK1Z□	—	77nH ±10%	100MHz	1100mA	0.090Ω	2000MHz
LQW15CNR11J1Z□	—	106nH ±5%	100MHz	850mA	0.144Ω	1500MHz
LQW15CNR11K1Z□	—	106nH ±10%	100MHz	850mA	0.144Ω	1500MHz
LQW15CNR14J1Z□	—	140nH ±5%	100MHz	650mA	0.216Ω	1000MHz
LQW15CNR14K1Z□	—	140nH ±10%	100MHz	650mA	0.216Ω	1000MHz
LQW15CNR18J1Z□	—	180nH ±5%	100MHz	560mA	0.312Ω	1000MHz
LQW15CNR18K1Z□	—	180nH ±10%	100MHz	560mA	0.312Ω	1000MHz
LQW15CNR22J1Z□	—	220nH ±5%	100MHz	450mA	0.47Ω	1400MHz
LQW15CNR22K1Z□	—	220nH ±10%	100MHz	450mA	0.47Ω	1400MHz
LQW15CNR27J1Z□	—	270nH ±5%	100MHz	420mA	0.52Ω	830MHz
LQW15CNR27K1Z□	—	270nH ±10%	100MHz	420mA	0.52Ω	830MHz
LQW15CNR33J1Z□	—	330nH ±5%	100MHz	390mA	0.56Ω	520MHz
LQW15CNR33K1Z□	—	330nH ±10%	100MHz	390mA	0.56Ω	520MHz
LQW15CNR39J1Z□	—	390nH ±5%	100MHz	370mA	0.62Ω	450MHz
LQW15CNR39K1Z□	—	390nH ±10%	100MHz	370mA	0.62Ω	450MHz
LQW15CNR42J1Z□	—	420nH ±5%	10MHz	370mA	0.62Ω	400MHz
LQW15CNR42K1Z□	—	420nH ±10%	10MHz	370mA	0.62Ω	400MHz
LQW15CNR47J1Z□	—	470nH ±5%	10MHz	350mA	0.66Ω	380MHz
LQW15CNR47K1Z□	—	470nH ±10%	10MHz	350mA	0.66Ω	380MHz
LQW15CNR56J1Z□	—	560nH ±5%	10MHz	300mA	0.71Ω	300MHz
LQW15CNR56K1Z□	—	560nH ±10%	10MHz	300mA	0.71Ω	300MHz

Operating temp.range (Self-temp.rise not included): -40 to 125°C

Class of Magnetic Shield: No Shield

Only for reflow soldering

\*S.R.F: Self Resonant Frequency

In operating temperatures exceeding +85°C, derating of current is necessary for the LQW15C series. Please apply the derating curve shown in the chart according to the operating temperature. Please consider "Notice (Rating)."

Continued on the following page. ↗

Continued from the preceding page. ↘

**Inductance-Frequency Characteristics (Typ.)**

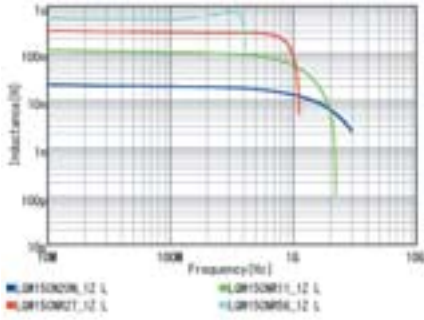

**Q-Frequency Characteristics (Typ.)**

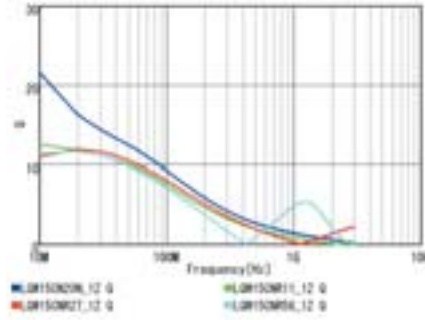

**Notice (Rating)**

In operating temperatures exceeding +85°C, derating of current is necessary for this series.

Please apply the derating curve shown in the chart according to the operating temperature.

**Derating of Rated Current**

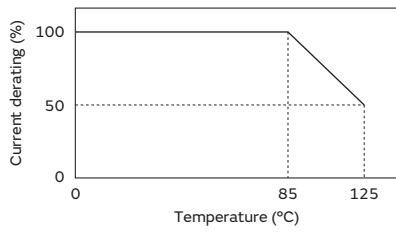



**RF Inductors**

# LQW18CN\_0Z Series 0603 (1608) inch (mm)

**Appearance/Dimensions**

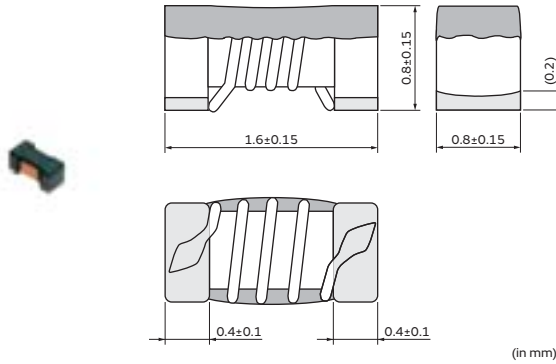

**Packaging**

Code	Packaging	Minimum Quantity
D	ø180mm Paper Taping	4000
J	ø330mm Paper Taping	10000
B	Packing in Bulk	500

**Rated Value (□: packaging code)**

Part Number		Inductance	Inductance Test Frequency	Rated Current	Max. of DC Resistance	S.R.F* (min.)
Infotainment	Powertrain/Safety					
LQW18CN4N9D0Z□	—	4.9nH ±0.5nH	10MHz	2600mA	0.015Ω	2300MHz
LQW18CN15NJ0Z□	—	15nH ±5%	10MHz	2200mA	0.025Ω	2000MHz
LQW18CN33NJ0Z□	—	33nH ±5%	10MHz	1700mA	0.035Ω	1800MHz
LQW18CN55NJ0Z□	—	55nH ±5%	10MHz	1500mA	0.045Ω	1600MHz
LQW18CN85NJ0Z□	—	85nH ±5%	10MHz	1400mA	0.060Ω	1380MHz
LQW18CNR10K0Z□	—	100nH ±10%	10MHz	1000mA	0.10Ω	1260MHz
LQW18CNR12J0Z□	—	120nH ±5%	10MHz	1100mA	0.085Ω	1200MHz
LQW18CNR16J0Z□	—	160nH ±5%	10MHz	1000mA	0.10Ω	900MHz
LQW18CNR21J0Z□	—	210nH ±5%	10MHz	800mA	0.15Ω	720MHz
LQW18CNR27J0Z□	—	270nH ±5%	10MHz	750mA	0.16Ω	660MHz
LQW18CNR33J0Z□	—	330nH ±5%	10MHz	630mA	0.25Ω	600MHz
LQW18CNR39J0Z□	—	390nH ±5%	10MHz	620mA	0.28Ω	570MHz
LQW18CNR47J0Z□	—	470nH ±5%	10MHz	500mA	0.45Ω	555MHz
LQW18CNR56J0Z□	—	560nH ±5%	10MHz	450mA	0.48Ω	540MHz
LQW18CNR65J0Z□	—	650nH ±5%	10MHz	430mA	0.52Ω	510MHz

Operating temp.range (Self-temp.rise not included): -40 to 125°C

Class of Magnetic Shield: No Shield

Only for reflow soldering

\*S.R.F: Self Resonant Frequency

In operating temperatures exceeding +85°C, derating of current is necessary for the LQW18CN\_0Z series. Please apply the derating curve shown in the chart according to the operating temperature. Please consider "Notice (Rating)."

**Inductance-Frequency Characteristics (Typ.)**

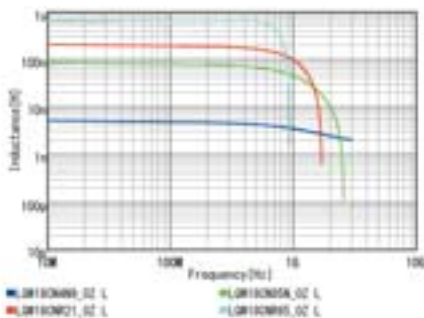

**Q-Frequency Characteristics (Typ.)**

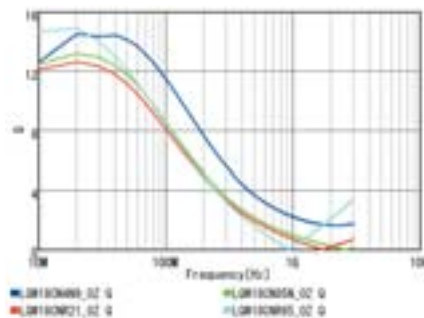

Continued on the following page. ↗

Continued from the preceding page. ↘

### Notice (Rating)

In operating temperatures exceeding +85°C, derating of current is necessary for this series.

Please apply the derating curve shown in the chart according to the operating temperature.

#### Derating of Rated Current

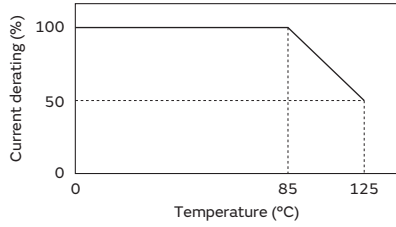

**RF Inductors**

# LQH31HZ\_03 Series 1206 (3216) inch (mm)

**Appearance/Dimensions**

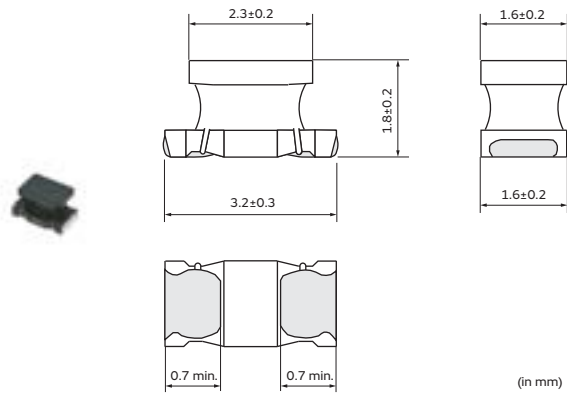

**Packaging**

Code	Packaging	Minimum Quantity
K	ø330mm Embossed Taping	7500
L	ø180mm Embossed Taping	2000

**Rated Value (□: packaging code)**

Part Number		Inductance	Inductance Test Frequency	Q (min.)	Q Test Frequency	Rated Current	DC Resistance	S.R.F* (min.)
Infotainment	Powertrain/Safety							
LQH31HZ54NK03□	—	54nH ±10%	1MHz	50	100MHz	920mA	0.035Ω±30%	800MHz
LQH31HZ95NK03□	—	95nH ±10%	1MHz	60	100MHz	790mA	0.047Ω±30%	650MHz
LQH31HZR14J03□	—	145nH ±5%	1MHz	60	100MHz	700mA	0.061Ω±30%	500MHz
LQH31HZR14K03□	—	145nH ±10%	1MHz	60	100MHz	700mA	0.061Ω±30%	500MHz
LQH31HZR21J03□	—	215nH ±5%	1MHz	60	100MHz	520mA	0.11Ω±30%	430MHz
LQH31HZR21K03□	—	215nH ±10%	1MHz	60	100MHz	520mA	0.11Ω±30%	430MHz
LQH31HZR29J03□	—	290nH ±5%	1MHz	60	100MHz	420mA	0.17Ω±30%	360MHz
LQH31HZR29K03□	—	290nH ±10%	1MHz	60	100MHz	420mA	0.17Ω±30%	360MHz
LQH31HZR39J03□	—	390nH ±5%	1MHz	60	100MHz	330mA	0.26Ω±30%	300MHz
LQH31HZR39K03□	—	390nH ±10%	1MHz	60	100MHz	330mA	0.26Ω±30%	300MHz
LQH31HZR50J03□	—	500nH ±5%	1MHz	60	100MHz	260mA	0.44Ω±30%	270MHz
LQH31HZR50K03□	—	500nH ±10%	1MHz	60	100MHz	260mA	0.44Ω±30%	270MHz
LQH31HZR61J03□	—	610nH ±5%	1MHz	60	100MHz	250mA	0.48Ω±30%	240MHz
LQH31HZR61K03□	—	610nH ±10%	1MHz	60	100MHz	250mA	0.48Ω±30%	240MHz
LQH31HZR75J03□	—	750nH ±5%	1MHz	60	100MHz	190mA	0.79Ω±30%	220MHz
LQH31HZR75K03□	—	750nH ±10%	1MHz	60	100MHz	190mA	0.79Ω±30%	220MHz
LQH31HZR88J03□	—	880nH ±5%	1MHz	60	100MHz	180mA	0.86Ω±30%	200MHz
LQH31HZR88K03□	—	880nH ±10%	1MHz	60	100MHz	180mA	0.86Ω±30%	200MHz

Operating temp.range (Self-temp.rise not included): -40 to 85°C

\*S.R.F: Self Resonant Frequency

**Inductance-Frequency Characteristics (Typ.)**

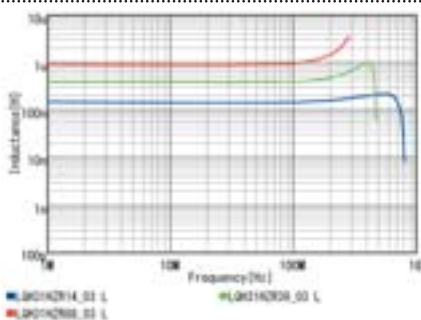

**Q-Frequency Characteristics (Typ.)**

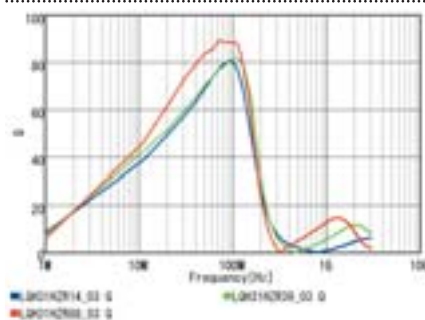

## RF Inductors ⚠️Caution/Notice

### ⚠️Caution

#### Rating

##### 1. About the Rated Current

Do not use products beyond the rated current as this may create excessive heat and deteriorate the insulation resistance.

For the usage of powertrain and safety be sure to provide an appropriate fail-safe function on your product to prevent a second damage that may be caused by the abnormal function or the failure of our product.

##### 2. About Excessive Surge Current

Surge current (pulse current or rush current) greater than the specified rated current applied to the product may cause a critical failure, such as an open circuit, burnout caused by excessive temperature rise.

Please contact us in advance in case of applying the surge current.

### Notice

#### Storage and Operating Condition

##### <Operating Environment>

Do not use products in chemical atmosphere such as chlorine gas, acid or sulfide gas.

##### <Storage Requirements>

##### 1. Storage Period

LQG series should be used within 6 months; the other products should be used within 12 months.

Check solderability if this period is exceeded.

##### 2. Storage Conditions

(1) Store products in a warehouse in compliance with the following conditions:

Temperature: -10 to +40 degrees C.

Humidity: 15 to 85% (relative humidity)

Do not subject products to rapid changes in temperature and humidity.

Do not store them in chemical atmosphere such as one containing sulfurous acid gas or alkaline gas.

This will prevent electrode oxidation, which causes poor solderability and possible corrosion of inductors.

(2) Do not store products in bulk packaging to prevent collision among inductors, which causes core chipping and wire breakage.

(3) Store products on pallets to protect from humidity, dust, etc.

(4) Avoid heat shock, vibration, direct sunlight, etc.

(5) Products should be stored under the airtight packaged condition. (LQG Series)

#### Handling

This item is designed to have sufficient strength, but handle with care to avoid chipping or breaking its ceramic structure.

##### LQW\_A/C series

- To prevent breaking the wire, avoid touching with sharp material, such as tweezers or the bristles of a cleaning brush, to the wire wound portion.
- To prevent breaking the core, avoid applying excessive mechanical shock to products mounted on the board.
- In some mounting machines, when picking up components, a support pin pushes the components up from the bottom of the base tape. In this case, please remove the support pin. The support pin may damage the components and break the wire.
- In rare cases, the laser recognition cannot recognize this component. Please contact us when you use laser recognition. (There is no problem with the permeation and reflection type.) (LQW15A Series only)

##### <Transportation>

Do not apply excessive vibration or mechanical shock to products.

##### <Resin Coating>

When coating products with resin, the relatively high resin curing stress may change inductance values. For exterior coating, select resin carefully so that electrical and mechanical performance of the product is not affected. Prior to use, please evaluate reliability with the product mounted in your application set.

Continued on the following page. ↗

## RF Inductors ⚠️Caution/Notice

Continued from the preceding page. ↘

### (LQW series)

An open circuit issue may occur by mechanical stress caused by the resin, amount/cured shape of resin, or operating conditions, etc. Some resins containing impurities or chloride may possibly generate chlorine by hydrolysis under some operating conditions, causing corrosion of the inductor wire and leading to an open circuit.

### (LQP series)

When products are coated with resin, please contact us in advance.

### <Handling of a Substrate>

After mounting products on a substrate, do not apply any stress to the product caused by bending or twisting the substrate when cropping the substrate, inserting and removing a connector from the substrate, or tightening a screw to the substrate.

Excessive mechanical stress may cause cracking in the Product.

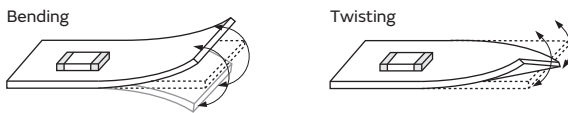

### Substrate restriction (LQP Series)

- Don't mount on FPC (Flexible printed circuits)
  - When components are mounted on substrate of under 6-layers, please contact us in advance.
- To mount components on FPC or substrate of under 6-layers may cause of cracking issue by stress.

- (1) There is a possibility of chip cracking caused by PCB expansion/contraction with heat, because stress on a chip is different depending on PCB material and structure.

When the thermal expansion coefficient greatly differs between the board used for mounting and the chip, it will cause cracking of the chip due to the thermal expansion and contraction.

The chip is assumed to be mounted on the PCB of glass-epoxy material, and we don't test with other PCB material which has different thermal expansion coefficient from Glass-epoxy.

When other PCB materials are considered, please be sure to evaluate by yourself.

- (2) After mounting products on a substrate, do not apply any stress to the product caused by bending or twisting to the substrate when cropping the substrate, inserting and removing a connector from the substrate or tightening screw to the substrate.

Excessive mechanical stress may cause cracking in the product.

In case of the mounting on flexible PCB, there is a possibility of chip cracking caused by mechanical stress even from small bending or twisting.

When the flexible PCB is considered, please be sure to evaluate by yourself.

## Measuring Method

### Measuring Method of Inductance/Q

1. Residual elements and stray elements of test fixtures can be described by F-parameter as shown in the following:

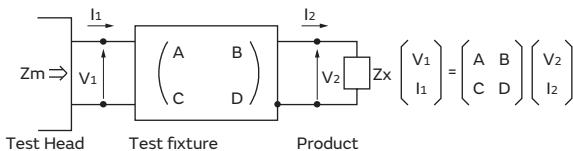

2. The impedance of chip Inductors (chip coils)  $Z_x$  and measured value  $Z_m$  can be described by input/output current/voltage.

$$Z_m = \frac{V_1}{I_1}, \quad Z_x = \frac{V_2}{I_2}$$

3. Thus, the relation between  $Z_x$  and  $Z_m$  is shown in the following:

$$Z_x = \alpha \frac{Z_m - \beta}{1 - Z_m \Gamma} \quad \text{where, } \alpha = D / A = 1$$

$$\beta = B / D = Z_{sm} - (1 - Y_{om} Z_{sm}) Z_{ss}$$

$$\Gamma = C / A = Y_{om}$$

$Z_{sm}$ : measured impedance of short chip  
 $Z_{ss}$ : residual impedance of short chip\*  
 $Y_{om}$ : measured admittance when opening the fixture

\*Residual inductance of short chip

Residual Inductance	Series
0nH	LQG15H, LQG18HH
0.480nH	LQP03TN
0.556nH	LQG15W, LQW15A/C
0.771nH	LQH31H, LQW18AN/C

4.  $L_x$  and  $Q_x$  should be calculated with the following equation.

$$L_x = \frac{\text{Im}(Z_x)}{2\pi f}, \quad Q_x = \frac{\text{Im}(Z_x)}{\text{Re}(Z_x)}$$

$L_x$ : Inductance of chip Inductors (chip coils)  
 $Q_x$ : Q of chip Inductors (chip coils)  
 $f$ : Measuring frequency

# RF Inductors Soldering and Mounting

## 1. Standard Land Pattern Dimensions

A high Q value is achieved when the PCB electrode land pattern is designed so that it does not project beyond the chip Inductors (chip coils) electrode.



Series	Standard Land Dimensions				
LQG15H LQG18H LQG15W LQH31H LQP03 LQW15A/C LQW18A		Part Number	a	b	c
		LQG15H	0.4	1.4-1.5	0.5-0.6
		LQG18H	0.6-0.8	1.8-2.2	0.6-0.8
		LQH31H	1.0	4.5	1.5
		LQP03	0.2-0.3	0.8-0.9	0.2-0.3
		LQG15W, LQW15A (Except for _8Z)	0.5	1.2	0.65
		LQW15A_8Z	0.6	1.42	0.66
		LQW15C_0Z	0.4	1.4	0.6
		LQW15C_1Z	0.4	1.4	0.66
		LQW18A (Except for _8Z)	0.6-0.8	1.9-2.0	0.7-1.0
		LQW18A_8Z	0.86	2.0	1.15
		LQW18C	0.7	2.2	1.0

Attention should be paid to potential magnetic coupling effects when using the Inductors (coils) as a resonator.

## 2. Standard Soldering Conditions

### (1) Soldering method

Chip Inductors (Chip coils) can be flow or reflow soldered.  
 Please contact Murata regarding other soldering methods.  
 As for LQG, LQP, LQW series, please use reflow soldering.  
 Solder: Use Sn-3.0Ag-0.5Cu solder.

Flux: Use rosin-based flux, but not strongly acidic flux (with chlorine content exceeding 0.2wt%).  
 Do not use water-soluble flux.  
 The flux used for LQW series should use the rosin-based flux that includes middle activator equivalent to 0.06wt% to 0.1wt% chlorine.  
 For additional mounting methods, please contact Murata.

### (2) Soldering profile

● Reflow Soldering profile  
 (Sn-3.0Ag-0.5Cu solder)

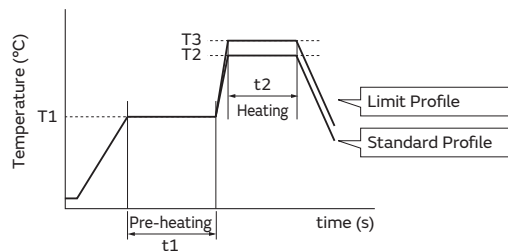

Series	Pre-heating		Standard Profile			Limit Profile		
	Temp. (T1)	Time. (t1)	Heating		Cycle of flow	Heating		Cycle of flow
			Temp. (T2)	Time. (t2)		Temp. (T3)	Time. (t2)	
LQH31H	150°C	60s min.	250°C	4 to 6s	2 times max.	265±3°C	5s max.	2 times max.

Continued on the following page. ↗

## RF Inductors Soldering and Mounting

Continued from the preceding page. ↘

### ●Reflow Soldering profile (Sn-3.0Ag-0.5Cu solder)

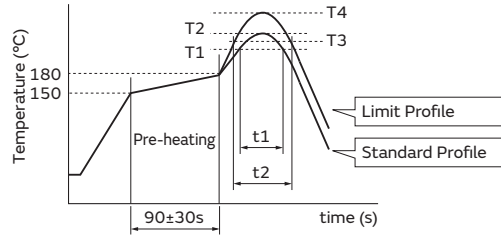

Series	Standard Profile				Limit Profile			
	Heating		Peak temperature (T2)	Cycle of reflow	Heating		Peak temperature (T4)	Cycle of reflow
	Temp. (T1)	Time. (t1)			Temp. (T3)	Time. (t2)		
LQG15H/W, 18H LQH31H LQP03 LQW15A/C, 18A/C	220°C	30 to 60s	245±3°C	2 times max.	230°C	60s max.	260°C/10s	2 times max.

### (3) Reworking with Soldering Iron

Preheating at 150°C for 1 minute is required. Do not directly touch the products with the tip of the soldering iron in order to prevent the crack on the products due to the thermal shock.

Soldering iron power output: 80W max.

Temperature of soldering iron tip: 350°C

Diameter of soldering iron end: 3.0mm max.

Soldering time: within 3 s

Please keep the fix time with the soldering iron within 2 times.

### 3. Mounting Instructions

#### (1) Land Pattern Dimensions

Large lands reduce Q of the mounted chip. Also, large protruding land areas (bordered by lines having dimensions 'c' and 'd' shown) cause floating and electrode leaching.

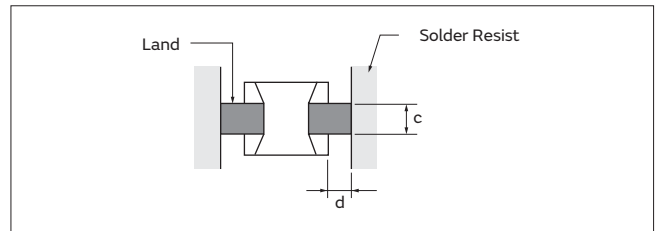

#### (2) Land Pattern Designing (LQW series)

Please follow the recommended patterns.

Otherwise, their performance, which includes electrical performance or solderability, may be affected, or result in "position shift" in the soldering process.

#### (3) PCB Warping

PCB should be designed so that products are not subjected to the mechanical stress caused by warping the board.

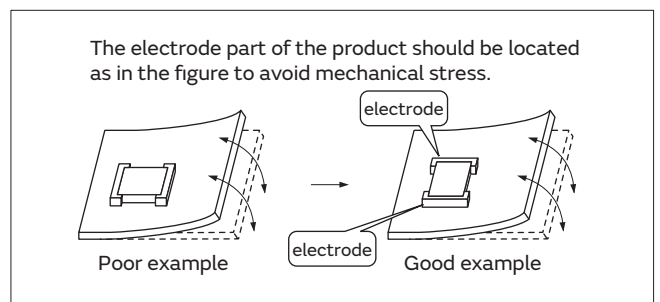
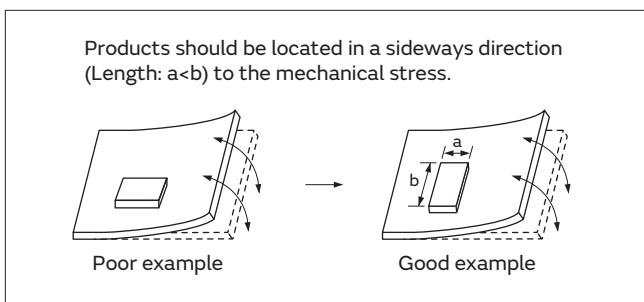

Continued on the following page. ↗

## RF Inductors Soldering and Mounting

Continued from the preceding page. ↘

### (4) Amount of Solder Paste

Excessive solder causes electrode corrosion, while insufficient solder causes low electrode bonding strength. Adjust the amount of solder paste as shown on the right so that solder is applied.

Guideline of solder paste thickness

- LQW15C: 50 to 100 $\mu$ m
- LQP03TN: 60 to 100 $\mu$ m
- LQG, LQW15A/LQW18A/C: 100 to 150 $\mu$ m
- LQH31H: 200 to 300 $\mu$ m

### LQW15A Series:

Too much solder may cause slant or rotation of the chip at the time of solder melting. Please reduce the amount of solder by using a smaller solder area than the land pattern, as shown in the figure at right.

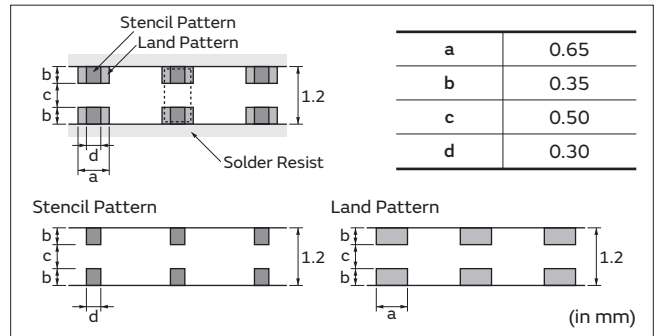
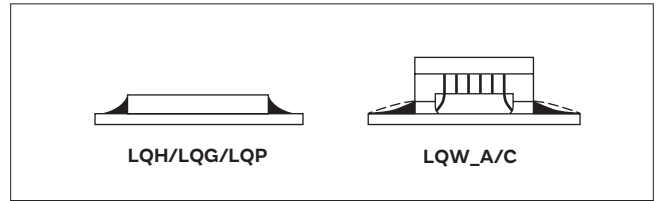

## 4. Cleaning

The following conditions should be observed when cleaning chip inductors (chip coils):

- (1) Cleaning Temperature: 60°C max. (40°C max. for alcohol cleaning agents)
- (2) Ultrasonic
  - Output: 20W/l max.
  - Duration: 5 minutes max.
  - Frequency: 28 to 40kHz
  - Care should be taken not to cause resonance of the PCB and mounted products.
- (3) Cleaning agent
 

The following cleaning agents have been tested on individual components. Evaluation in complete assembly should be done prior to production.

  - (a) Alcohol cleaning agents
    - Isopropyl alcohol (IPA)
  - (b) Aqueous cleaning agents
    - Pine Alpha ST-100S

- (4) Ensure that flux residue is completely removed. Component should be thoroughly dried after aqueous agents have been removed with deionized water.

For additional cleaning methods, please contact Murata.



## RF Inductors Packaging

### Minimum Quantity and 8mm Width Taping Dimensions (1)

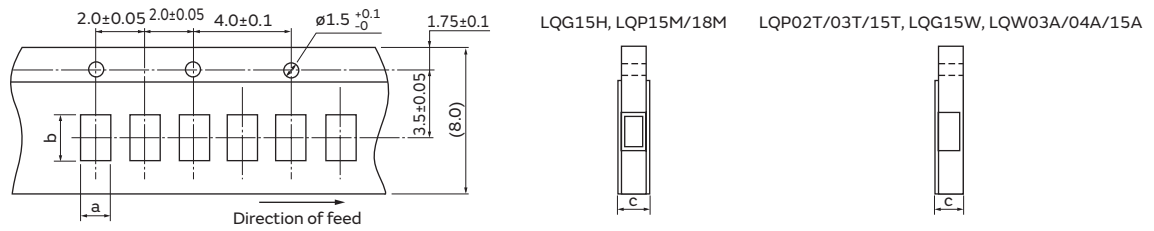

#### Paper Tape

Part Number	Dimensions		Total Thickness of Tape	Packaging Code (Minimum Qty. [pcs.])		
	a	b		c	ø180mm reel	ø330mm reel
LQG15H	0.62	1.12	0.8 max.	D (10000)	J (50000)	B (1000)
LQG15W	0.69	1.18	0.85 max.	D (10000)	J (40000)	B (100)
LQP03T *1	0.35	0.65/0.67	0.55 max.	D (15000)	J (50000)	B (500)
LQW15A_OZ *2	0.64/0.66/0.69	1.18	0.8 max.	D (10000)	-	B (500)
LQW15A_1Z *3	0.66/0.69	1.18	0.8 max.	D (10000)	-	B (500)
LQW15A_8Z	0.75	1.18	0.8 max.	D (10000)	-	B (500)
LQW15C_OZ *4	0.64/0.66	1.18	0.8 max.	D (10000)	-	B (500)
LQW15C_1Z	0.69	1.18	0.8 max.	D (10000)	-	B (500)

\*1 0.67 (LQP03TN\_Z2; 0.6-62nH)  
 0.65 (LQP03TN\_Z2; 68-120nH)

\*2 0.69 (1.5nH, 2.4-2.8nH, 3.9-4.8nH, 5.8-6.8nH, 8.2-9.9nH, 11nH, 12nH, 15nH)  
 0.66 (1.6-1.8nH, 2.9nH, 3.0nH, 3.1nH, 3.2nH, 4.9-5.1nH, 6.9-7.5nH, 10nH, 13nH, 16-23nH, 100nH, 120nH)  
 0.64 (24-91nH)

\*3 0.69 (1.3nH, 1.4nH)  
 0.66 (2.2-8.4nH)

\*4 0.64 (70nH-200nH)  
 0.66 (18nH-48nH)

(in mm)

### Minimum Quantity and 8mm Width Taping Dimensions (2)

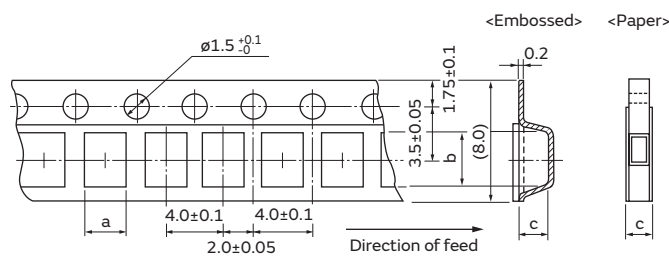

Dimension of the cavity of embossed tape is measured at the bottom side.

#### Paper Tape

Part Number	Dimensions		Total Thickness of Tape	Packaging Code (Minimum Qty. [pcs.])		
	a	b		c	ø180mm reel	ø330mm reel
LQG18H	1.05	1.85	1.1 max.	D (4000)	J (10000)	B (1000)
LQW18A_OZ/18C	1.0	1.8	1.1 max.	D (4000)	J (10000)	B (500)
LQW18A_1Z	1.1	1.9	1.1 max.	D (4000)	J (10000)	B (500)
LQW18A_8Z	1.15	1.9	1.1 max.	D (4000)	J (10000)	B (500)
LQW18AS_OZ	1.06	1.86	1.1 max.	D (4000)	J (10000)	B (500)

#### Embossed Tape

Part Number	Dimensions		Total Thickness of Tape	Packaging Code (Minimum Qty. [pcs.])		
	a	b		c	ø180mm reel	ø330mm reel
LQH31	1.9	3.6	2.0	L (2000)	K (7500)	-

(in mm)

# Part Number Quick Reference

## EMI Suppression Filters (for DC)

### Chip Ferrite Bead

BLE18PS	106
BLE32PN	107
BLM03AG	18
BLM03AX	16
BLM03BB	20
BLM03BC	20
BLM03BD	20
BLM03EB	26
BLM03HB	23
BLM03HD	23
BLM03HG	23
BLM03PG	15
BLM03PX	13
BLM15AG	34
BLM15AX	32
BLM15BA	38
BLM15BB	38
BLM15BC	38
BLM15BD	38
BLM15BX	36
BLM15EG	47
BLM15GA	49
BLM15GG	49
BLM15HB	42
BLM15HD	42
BLM15HG	42
BLM15HG (150°C available)	45
BLM15PD	30
BLM15PG	30
BLM15PX	28
BLM18AG	61
BLM18AG (150°C available)	65
BLM18AG (for conductive glue mounting)	63

BLM18BA	67
BLM18BB	67
BLM18BD	67
BLM18BD (150°C available)	72
BLM18EG	79
BLM18G	82
BLM18HB	75
BLM18HD	75
BLM18HE	75
BLM18HG	75
BLM18KG	55
BLM18KG (150°C available)	58
BLM18PG	50
BLM18SG	52
BLM18SN	54
BLM21AG	88
BLM21AG (150°C available)	90
BLM21BB	92
BLM21BD	92
BLM21PG	83
BLM21PG (150°C available)	85
BLM21SN	87
BLM31AJ	103
BLM31KN	98
BLM31KN (150°C available)	100
BLM31PG	96
BLM31SN	102
BLM41PG	104

NFZ32BW_10	123
NFZ32BW_11	126
NFZ5BBW_10	129

### Chip Common Mode Choke Coil

DLM11S	143
DLW21S	144
DLW31S	146
DLW32S	147
DLW43M	148
DLW43S	149
DLW5AT	151
DLW5BS	154
DLW5BT	155
PLT10H	159
PLT5BP	157
UCMH0907	161

### Block Type EMIFIL®

BNX02□	176
--------	-----

### Lead Type

BLL18AG	185
BNX012	191
DSS1	187
VFC2	190

### Microchip Transformer (Balun)

DXW21B	203
--------	-----

### Chip EMIFIL®

NFE31ZT	118
NFE61HT	119
NFL18ZT	120
NFZ18SM_10	121

## Chip Inductors

### Inductors for Power Lines

DFE201612P_D	214
DFE252012P_D	216
DFEG10040D	222
DFEG12060D	226
DFEG7030D	218
DFEH10040D	224
DFEH12060D	228
DFEH7030D	220
LQH2HPZ_DR	232
LQH2HPZ_GR	234
LQH2HPZ_JR	236
LQH2MPZ_GR	230
LQH32CH_23	238
LQH32CH_33	239
LQH32CH_53	240
LQH32DZ_23	241
LQH32DZ_53	242
LQH32PH_N0	243
LQH32PH_NC	245
LQH32PZ_N0	243
LQH32PZ_NC	245
LQH3NPZ_GR	247
LQH3NPZ_JR	249
LQH3NPZ_ME	251
LQH43PH_26	255
LQH43PZ_26	255
LQH44PZ_GR	253

LQH5BPZ_T0	257
LQM18PZ_CH	283
LQM18PZ_DH	285
LQM18PZ_FH	286
LQM21PH_GC	291
LQM21PZ_CO	287
LQM21PZ_GO	289
LQM21PZ_GC	291
LQM21PZ_GR	293
LQM2HPZ_E0	298
LQM2HPZ_GO	299
LQM2HPZ_GC	301
LQM2HPZ_GS	302
LQM2HPZ_JO	303
LQM2MPZ_GO	295
LQM2MPZ_JH	297
MBH10145C	275
MBH12282C	277
MBH12575C	281
MBH6045C High Current	259
MBH6045C Low Rdc	261
MBH7045C High Current	267
MBH7045C Low Rdc	269
MDH10060C	273
MDH12577C	279
MDH6045C High Current	263
MDH6045C Low Rdc	265
MDH7045C	271

### Inductors for General Circuits

5CCEG	325
FSDVA	326
HEAW	324
HEAWS	323
LQH32NH_23	318
LQH32NZ_23	318
LQH43NZ_03	320

### RF Inductors

LQG15HH_02	338
LQG15HZ_02	338
LQG15WH_02	341
LQG15WZ_02	341
LQG18HH_00	347
LQH31HZ_03	385
LQP03TN_Z2	349
LQW15AN_OZ	353
LQW15AN_1Z	359
LQW15AN_8Z	361
LQW15CN_OZ	379
LQW15CN_1Z	381
LQW18AN_OZ	368
LQW18AN_1Z	371
LQW18AN_8Z	372
LQW18AS_OZ	376
LQW18CN_OZ	383

# Global Locations

For details please visit [www.murata.com](http://www.murata.com)



## ⚠ Note

### 1 Export Control

*For customers outside Japan:*

No Murata products should be used or sold, through any channels, for use in the design, development, production, utilization, maintenance or operation of, or otherwise contribution to (1) any weapons (Weapons of Mass Destruction [nuclear, chemical or biological weapons or missiles] or conventional weapons) or (2) goods or systems specially designed or intended for military end-use or utilization by military end-users.

*For customers in Japan:*

For products which are controlled items subject to the "Foreign Exchange and Foreign Trade Law" of Japan, the export license specified by the law is required for export.

2 Please contact our sales representatives or product engineers before using the products in this catalog for the applications listed below, which require especially high reliability for the prevention of defects which might directly damage a third party's life, body or property, or when one of our products is intended for use in applications other than those specified in this catalog.

- ① Aircraft equipment
- ② Aerospace equipment
- ③ Undersea equipment
- ④ Power plant equipment
- ⑤ Medical equipment
- ⑥ Transportation equipment (vehicles, trains, ships, etc.)
- ⑦ Traffic signal equipment
- ⑧ Disaster prevention / crime prevention equipment
- ⑨ Data-processing equipment
- ⑩ Application of similar complexity and/or reliability requirements to the applications listed above

3 Product specifications in this catalog are as of November 2017. They are subject to change or our products in it may be discontinued without advance notice. Please check with our sales representatives or product engineers before ordering. If there are any questions, please contact our sales representatives or product engineers.

4 Please read rating and ⚠CAUTION (for storage, operating, rating, soldering, mounting and handling) in this catalog to prevent smoking and/or burning, etc.

5 This catalog has only typical specifications. Therefore, please approve our product specifications or transact the approval sheet for product specifications before ordering.

6 Please note that unless otherwise specified, we shall assume no responsibility whatsoever for any conflict or dispute that may occur in connection with the effect of our and/or a third party's intellectual property rights and other related rights in consideration of your use of our products and/or information described or contained in our catalogs. In this connection, no representation shall be made to the effect that any third parties are authorized to use the rights mentioned above under licenses without our consent.

7 No ozone depleting substances (ODS) under the Montreal Protocol are used in our manufacturing process.

Murata Manufacturing Co., Ltd.

[www.murata.com](http://www.murata.com)

**muRata**  
INNOVATOR IN ELECTRONICS

单击下面可查看定价，库存，交付和生命周期等信息

[>>Murata\(村田\)](#)

[>>点击查看相关商品](#)