

200mA High Speed LDO Voltage Regulator with Inrush Current Prevention

GENERAL DESCRIPTION

The XC6233 series is a 200mA high speed LDO regulator that features high accurate high ripple rejection and low dropout. The series consists of a voltage reference, an error amplifier, a driver transistor, a current limiter, a phase compensation circuit and an inrush current prevention circuit.

The output voltage is selectable in 0.05V increments (Accuracy $\pm 1\%$) within the range of 1.2V to 3.6V.

The CE function enables the circuit to be in stand-by mode as well as the electric charge at the output capacitor C_L to be discharged via the internal switch, and the V_{OUT} pin quickly returns to the Low level.

The series is also compatible with low ESR ceramic capacitors, which provides stable output voltage. This stability can be maintained even during load fluctuations due to the excellent transient response.

The over current prevention circuit will operate when the output current reaches the current limit.

APPLICATIONS

- Mobile devices / terminals
- Modules (wireless, cameras, etc.)
- Smart phones / Mobile phones

FEATURES

- Maximum Output Current : 200mA
- Input Voltage Range : 1.7V ~ 5.5V
- Output Voltage Range : 1.2V ~ 3.6V ($\pm 1\%$) 0.05V increments
- Dropout Voltage : 240mV @ $I_{OUT}=200\text{mA}$ ($V_{OUT}=3.0\text{V}$)
- Low Power Consumption : 45 μA (TYP.)
- Stand-by Current : 0.1 μA
- High Ripple Rejection : 75dB@1kHz
- CE Pin Function : Active High
 C_L Auto Discharge
- Protection Circuit : Current Limit 255mA (TYP.)
 Short Circuit Protection 60mA (TYP.)
- External Capacitor : Ceramic Capacitor Compatible 1.0 μF
- Operating Ambient Temperature : -40 ~ +85
- Packages : USP-4
 SSOT-24
 SOT-25
 USPQ-4B04
- Environmentally Friendly : EU RoHS Compliant, Pb Free

TYPICAL APPLICATION CIRCUIT

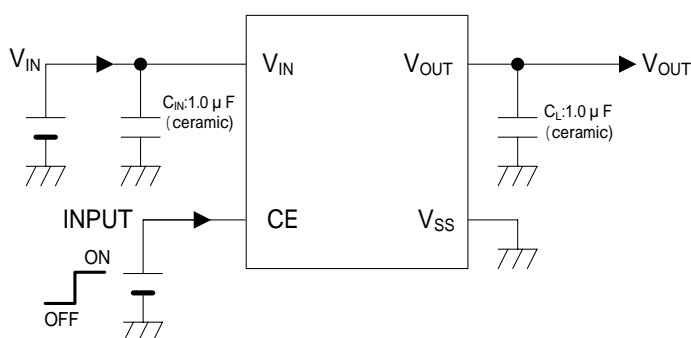

TYPICAL PERFORMANCE CHARACTERISTICS

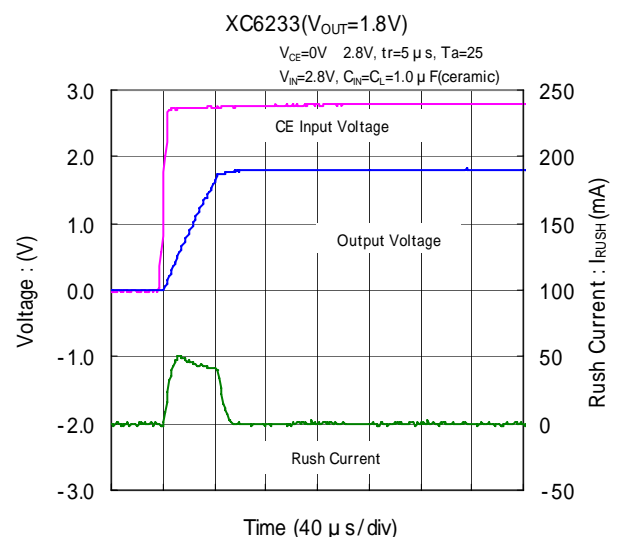

BLOCK DIAGRAM

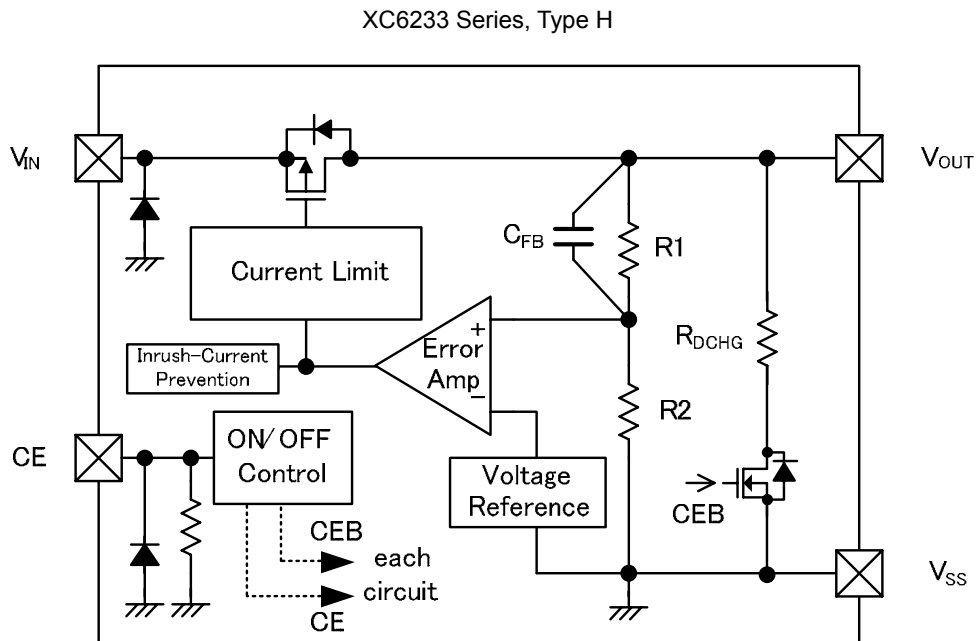

* Diodes inside the circuits are ESD protection diodes and parasitic diodes.

PRODUCT CLASSIFICATION

Ordering Information

XC6233 -

DESIGNATOR	ITEM	SYMBOL	DESCRIPTION
	Type of Regulator CE Active High	H	Refer to Function Guide
	Output Voltage	12 ~ 36	ex.) 2.80V → =2, =8 =please see down below
	Output Voltage Accuracy	1	0.10V increments, ±1% (V _{OUT} 2.00V), ±0.02V (V _{OUT} < 2.00V) e.g. 2.80V =1
		B	0.05V increments, ±1% (V _{OUT} 2.05V), ±0.02V (V _{OUT} < 2.05V) e.g. 2.85V =B
- (*1)	Packages (Order Unit)	9R-G	USPQ-4B04 (3000/Reel)
		GR-G	USP-4 (3000/Reel)
		NR-G	SSOT-24 (3000/Reel)
		MR-G	SOT-25 (3000/Reel)

(*1) The "-G" suffix denotes Halogen and Antimony free as well as being fully EU RoHS compliant.

For another type of regulators, please contact your local Torex sales office or representative.

Function Guide

TYPE	CURRENT LIMITER	CE PULL-DOWN RESISTOR	C _L AUTO-DISCHARGE	INRUSH CURRENT PREVENTION
H	Yes	Yes	Yes	Yes

STANDARD VOLTAGE

Examples for standard voltage

V _{OUT} (V)	PACKAGES			
	USPQ-4B04	USP-4	SSOT-24	SOT-25
1.20	XC6233H1219R-G	XC6233H121GR-G	XC6233H121NR-G	XC6233H121MR-G
1.50	XC6233H1519R-G	XC6233H151GR-G	XC6233H151NR-G	XC6233H151MR-G
1.80	XC6233H1819R-G	XC6233H181GR-G	XC6233H181NR-G	XC6233H181MR-G
2.80	XC6233H2819R-G	XC6233H281GR-G	XC6233H281NR-G	XC6233H281MR-G
3.30	XC6233H3319R-G	XC6233H331GR-G	XC6233H331NR-G	XC6233H331MR-G

Output voltages can be set internally from 1.2V to 3.6V. For other voltages, please contact your local Torex sales office or representative.

PIN CONFIGURATION

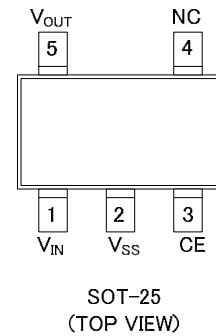
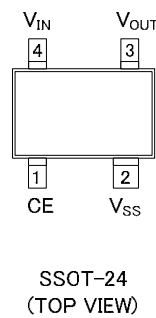
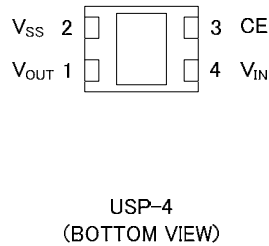
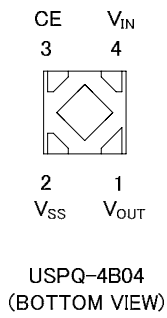

* The dissipation pad for the USP-4 and USPQ-4B04 packages should be solder-plated in reference mount pattern and metal masking so as to enhance mounting strength and heat release. If the pad needs to be connected to other pins, it should be connected to the V_{SS} (No. 2) pin.

PIN ASSIGNMENT

PIN NUMBER				PIN NAME	FUNCTIONS
USPQ-4B04	USP-4	SSOT-24	SOT-25		
1	1	3	5	V_{OUT}	Output
2	2	2	2	V_{SS}	Ground
3	3	1	3	CE	ON/OFF Control
4	4	4	1	V_{IN}	Power Supply Input
-	-	-	4	NC	No Connection

PIN FUNCTION ASSIGNMENT

PIN NAME	SIGNAL	STATUS
CE	L	Stand-by
	H	Active
	OPEN	Stand-by *

* For type H, CE pin voltage is fixed as L level because of internal pull-down resistor.

ABSOLUTE MAXIMUM RATINGS

Ta=25

PARAMETER	SYMBOL	RATINGS	UNITS
Input Voltage	V _{IN}	-0.3 ~ +6.0	V
Output Current	I _{OUT}	275 ^(*)	mA
Output Voltage	V _{OUT}	-0.3 ~ V _{IN} +0.3 or +6.0 ^(**)	V
CE Input Voltage	V _{CE}	-0.3 ~ +6.0	V
Power Dissipation	USPQ-4B04	550 (PCB mounted) ^(***)	mW
	USP-4	1000 (PCB mounted) ^(***)	
	SSOT-24	500 (PCB mounted) ^(***)	
	SOT-25	600 (PCB mounted) ^(***)	
Operating Ambient Temperature	Topr	-40 ~ +85	
Storage Temperature	Tstg	-55 ~ +125	

All voltages are described based on the V_{SS}.

(*) Please use within the range of I_{OUT} Pd/(V_{IN}-V_{OUT})

(**) The maximum rating corresponds to the lowest value between V_{IN}+0.3 or +6.0.

(***) This is a reference data taken by using the test board. Please refer to page 26 to 29 for details.

ELECTRICAL CHARACTERISTICS

XC6233 Series

Ta=25

PARAMETER	SYMBOL	CONDITIONS	MIN.	TYP.	MAX.	UNITS	CIRCUIT
Output Voltage	$V_{OUT(E)}$ ⁽¹⁾	$V_{OUT(T)} = 2.0V$	$V_{OUT(T)} \times 0.99$ ⁽²⁾	$V_{OUT(T)}$ ⁽²⁾	$V_{OUT(T)} \times 1.01$ ⁽²⁾	V	
			"E-0" ⁽³⁾				
		$V_{OUT(T)} < 2.0V$	$V_{OUT(T)} - 0.02$ ⁽²⁾	$V_{OUT(T)}$ ⁽²⁾	$V_{OUT(T)} + 0.02$ ⁽²⁾		
			"E-0" ⁽³⁾				
Maximum Output Current	I_{OUTMAX}	-	200	-	-	mA	
Load Regulation	ΔV_{OUT}	0.1mA I_{OUT} 200mA	-	25	45	mV	
Dropout Voltage	V_{dif} ⁽⁴⁾	$I_{OUT} = 200mA$	-	"E-1" ⁽⁵⁾		mV	
Supply Current	I_{DD}	$I_{OUT} = 0mA$	-	45	87	μA	
Stand-by Current	I_{STB}	$V_{CE} = V_{SS}$	-	0.01	0.10	μA	
Line Regulation	$\frac{\Delta V_{OUT}}{(\Delta V_{IN} \cdot V_{OUT})}$	$V_{OUT(T)} < 2.0V, I_{OUT} = 30mA$ 2.5V V_{IN} 5.5V	-	0.02	0.10	%V	
		$V_{OUT(T)} = 2.0V, I_{OUT} = 30mA$ $V_{OUT(T)} + 0.5V$ V_{IN} 5.5V					
Input Voltage	V_{IN}	-	1.7	-	5.5	V	
Output Voltage Temperature Characteristics	$\frac{\Delta V_{OUT}}{(\Delta T_{opr} \cdot V_{OUT})}$	$I_{OUT} = 10mA$ -40 T_{opr} 85	-	± 80	-	ppm/	
Power Supply Rejection Ratio	PSRR	$V_{OUT(T)} < 2.5V$ $V_{IN} = 3.0V_{DC} + 0.5V_{p-pAC}$ $V_{CE} = V_{OUT(T)} + 1.0V$ $I_{OUT} = 30mA, f = 1kHz$	-	75	-	dB	
		$V_{OUT(T)} = 2.5V$ $V_{IN} = \{V_{OUT(T)} + 1.0\} + 0.5V_{p-pAC}$ $V_{CE} = V_{OUT(T)} + 1.0V$ $I_{OUT} = 30mA, f = 1kHz$					
Current Limit	I_{LIM}	-	200	255	-	mA	
Short Current	I_{SHORT}	$V_{OUT} = V_{SS}$	-	60	-	mA	
CE "H" Level Voltage	V_{CEH}	-	0.9	-	5.5	V	
CE "L" Level Voltage	V_{CEL}	-	V_{SS}	-	0.3	V	
CE "H" Level Current (Type H)	I_{CEH}	$V_{CE} = V_{IN} = 5.5V$	2.5	6.0	9.5	μA	
CE "L" Level Current	I_{CEL}	$V_{CE} = V_{SS}$	-0.1	-	0.1	μA	
C_L Auto-Discharge Resistance	R_{DCHG}	$V_{IN} = 5.5V, V_{CE} = V_{SS}, V_{OUT} = 2.0V$	-	270	-	Ω	
Inrush Current	I_{RUSH}	$V_{IN} = 5.5V, V_{CE} = 0$ 5.5V	-	95	-	mA	

NOTE:

Unless otherwise stated, $V_{IN} = V_{OUT(T)} + 1V, V_{CE} = V_{IN}, I_{OUT} = 1mA$

⁽¹⁾ $V_{OUT(E)}$ is Effective output voltage

⁽²⁾ $V_{OUT(T)}$ is Nominal output voltage

⁽³⁾ E-0: OUTPUT VOLTAGE (Refer to the Voltage Chart)

⁽⁴⁾ $V_{dif} = \{V_{IN1} - V_{OUT1}\}$

V_{IN1} is the input voltage when V_{OUT1} appears at the V_{OUT} pin while input voltage is gradually decreased.

V_{OUT1} is the voltage equal to 98% of the normal output voltage when amply stabilized $V_{OUT(T)} + 1.0V$ is input at the V_{IN} pin.

⁽⁵⁾ E-1: DROPOUT VOLTAGE (Refer to the Voltage Chart)

ELECTRICAL CHARACTERISTICS (Continued)

Voltage Chart

NOMINAL OUTPUT VOLTAGE	E-0		E-1	
	OUTPUT VOLTAGE (V)		DROPOUT VOLTAGE (mV)	
	V _{OUT(E)}		V _{dif}	
V _{OUT(T)}	MIN.	MAX.	TYP.	MAX.
1.20	1.1800	1.2200	680	950
1.25	1.2300	1.2700		
1.30	1.2800	1.3200	640	800
1.35	1.3300	1.3700		
1.40	1.3800	1.4200	600	695
1.45	1.4300	1.4700		
1.50	1.4800	1.5200		
1.55	1.5300	1.5700		
1.60	1.5800	1.6200	510	630
1.65	1.6300	1.6700		
1.70	1.6800	1.7200		
1.75	1.7300	1.7700	400	600
1.80	1.7800	1.8200		
1.85	1.8300	1.8700		
1.90	1.8800	1.9200		
1.95	1.9300	1.9700	375	520
2.00	1.9800	2.0200		
2.05	2.0295	2.0705		
2.10	2.0790	2.1210		
2.15	2.1285	2.1715		
2.20	2.1780	2.2220		
2.25	2.2275	2.2725		
2.30	2.2770	2.3230		
2.35	2.3265	2.3735		
2.40	2.3760	2.4240		
2.45	2.4255	2.4745		

NOMINAL OUTPUT VOLTAGE	E-0		E-1	
	OUTPUT VOLTAGE (V)		DROPOUT VOLTAGE (mV)	
	V _{OUT(E)}		V _{dif}	
V _{OUT(T)}	MIN.	MAX.	TYP.	MAX.
2.50	2.4750	2.5250	310	420
2.55	2.5245	2.5755		
2.60	2.5740	2.6260		
2.65	2.6235	2.6765		
2.70	2.6730	2.7270		
2.75	2.7225	2.7775		
2.80	2.7720	2.8280		
2.85	2.8215	2.8785		
2.90	2.8710	2.9290		
2.95	2.9205	2.9795		
3.00	2.9700	3.0300	240	380
3.05	3.0195	3.0805		
3.10	3.0690	3.1310		
3.15	3.1185	3.1815		
3.20	3.1680	3.2320		
3.25	3.2175	3.2825		
3.30	3.2670	3.3330		
3.35	3.3165	3.3835		
3.40	3.3660	3.4340		
3.45	3.4155	3.4845		
3.50	3.4650	3.5350		
3.55	3.5145	3.5855		
3.60	3.5640	3.6360		

TEST CIRCUITS

$C_{IN}=1.0 \mu F$, $C_L=1.0 \mu F$

Circuit

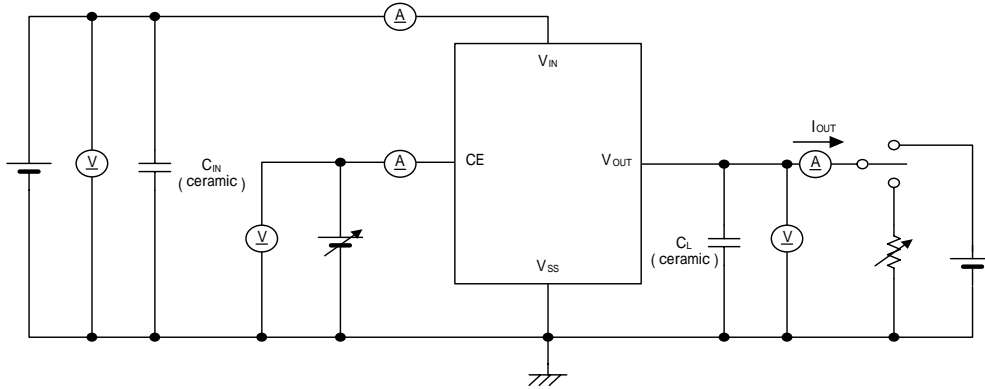

Circuit

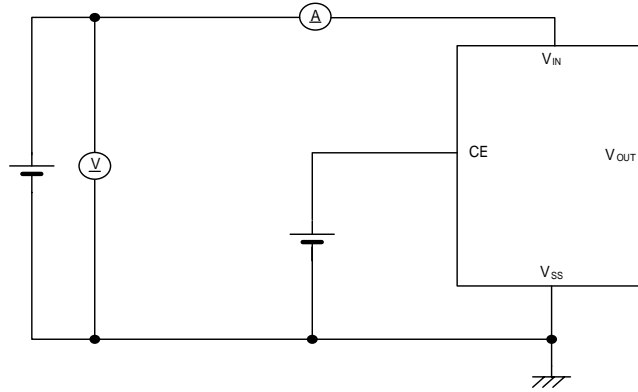

Circuit

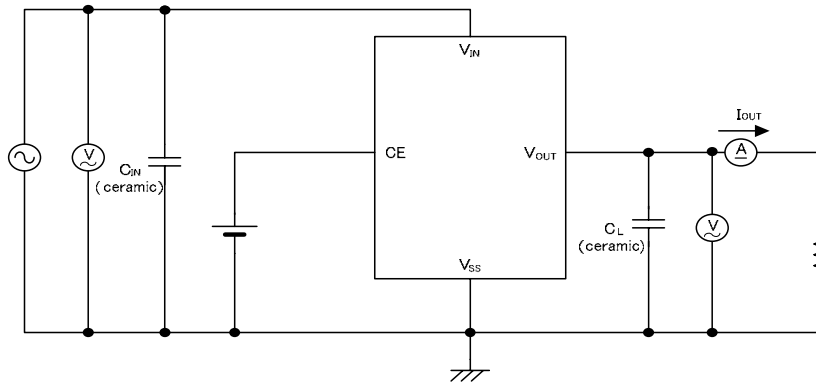

Circuit

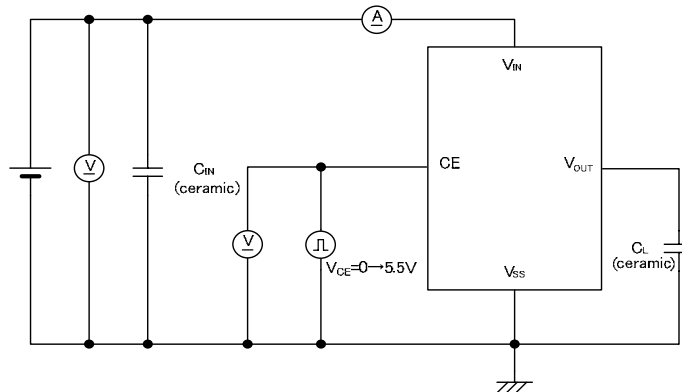

OPERATIONAL EXPLANATION

The voltage divided by resistors R1 & R2 is compared with the internal reference voltage by the error amplifier. The P-channel MOSFET which is connected to the V_{OUT} pin is then driven by the subsequent control signal. The output voltage at the V_{OUT} pin is controlled and stabilized by a system of negative feedback.

The current limit circuit and short circuit protection operate in relation to the level of output voltage and output current.

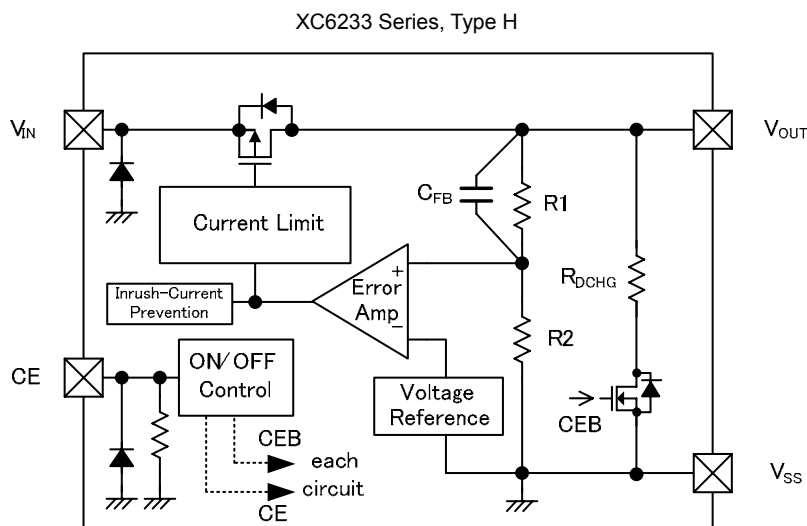

< Low ESR Capacitor >

The XC6233 series needs an output capacitor (C_L) for phase compensation. In order to ensure the stable phase compensation, please place an output capacitor of 1.0 μF at the V_{OUT} pin and V_{SS} pin as close as possible. For a stable power input, please connect an input capacitor (C_{IN}) of 1.0 μF between the input pin (V_{IN}) and the ground pin (V_{SS}).

<Current Limiter, Short-Circuit Protection >

The XC6233 series has current limiter and droop shape of fold-back circuit. When the load current reaches the current limit, the droop current limiter circuit operates and the output voltage drops with keeping the load current. After that, the output voltage drops to a certain level, the fold-back circuit operates and the output current goes to decrease with a degree of output voltage decreasing. The output current finally reaches at the level of 60mA (TYP.) when the output pin is short-circuited.

<CE Pin>

The IC's internal circuitry can be shutdown via the signal of the CE pin.

The XC6233H series has a pull-down resistor at the CE pin inside. Even the CE pin is left open, the CE pin is fixed as Low level. However, inflow current is generated into the CE pin.

OPERATIONAL EXPLANATION (Continued)

<C_L High-speed Discharge Function>

The N-ch transistor located between the V_{OUT} pin and the V_{SS} pin and the C_L discharge resistance is set to 270Ω (TYP.) when V_{IN} is 5.5V (TYP.) and V_{OUT} is 2.0V (TYP.).

This N-ch transistor can quickly discharge the electric charge at the output capacitor (C_L), when a low signal is inputted to the CE pin. Moreover, discharge time of the output capacitor (C_L) is set by the C_L auto-discharge resistance (R_{DCHG}) and the output capacitance (C_L).

By setting time constant of a C_L auto-discharge resistance (R_{DCHG}) and an output capacitance (C_L) as $\tau = C_L \times R_{DCHG}$, the output voltage after discharge via the N-ch transistor is calculated by the following formula.

$$V = V_{OUT(E)} \times e^{-t/\tau}$$

V: Output voltage after discharge

V_{OUT(E)}: Output voltage

t: Discharge time

τ : R_{DCHG} × C_L

C_L: Output capacitance

R_{DCHG}: C_L auto-discharge resistance

or discharge time is calculated by the next formula.

$$t = \tau \ln (V_{OUT(E)} / V)$$

< Inrush Current Prevention >

The inrush current prevention circuit is built in the XC6233 series.

When the IC starts to operate, the prevention circuit limits the inrush current as 95mA (TYP.) from input pin (V_{IN}) to output pin (V_{OUT}) for charging C_L capacitor. However, the device can not provide the output current beyond 95mA (TYP.) for a period of approximately 100 μs because internal control of the IC.

NOTES ON USE

1. For temporary, transitional voltage drop or voltage rising phenomenon, the IC is liable to malfunction should the ratings be exceeded.
2. Where wiring impedance is high, operations may become unstable due to noise and/or phase lag depending on output current. Please strengthen V_{IN} and V_{SS} wiring in particular.
3. Please wire the input capacitor (C_{IN}) and the output capacitor (C_L) as close to the IC as possible.
4. Torex places an importance on improving our products and their reliability.
We request that users incorporate fail-safe designs and post-aging prevention treatment when using Torex products in their systems.

TYPICAL PERFORMANCE CHARACTERISTICS

(1) Output Voltage vs. Output Current

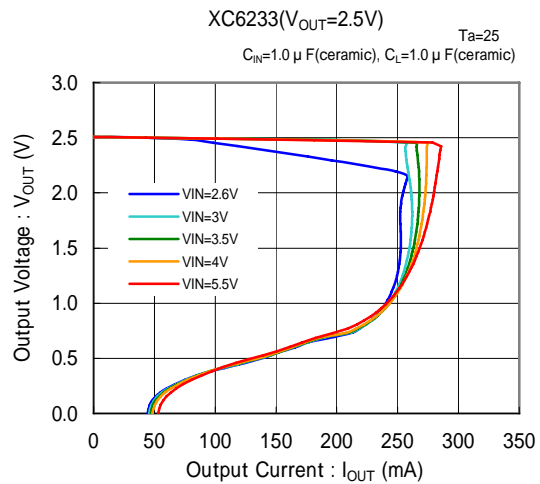
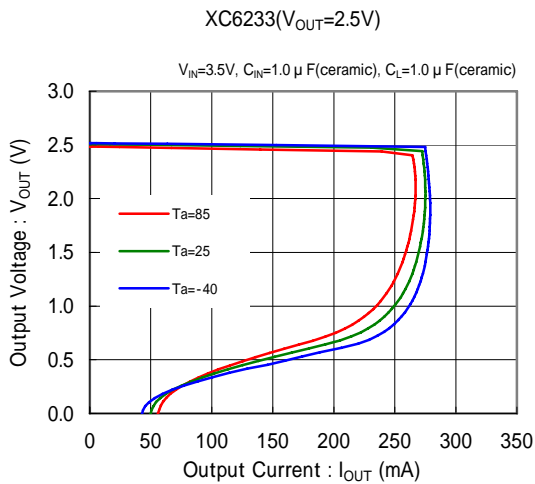
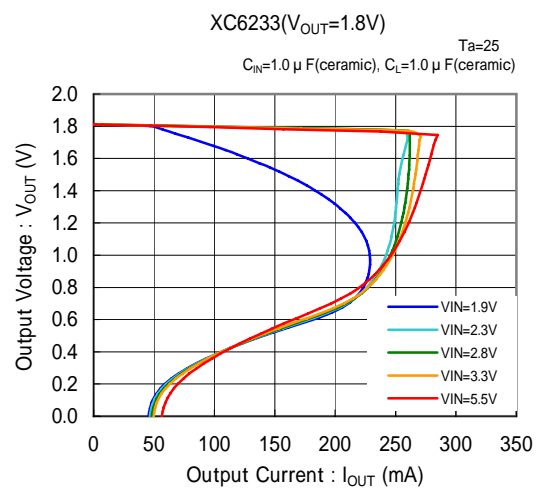
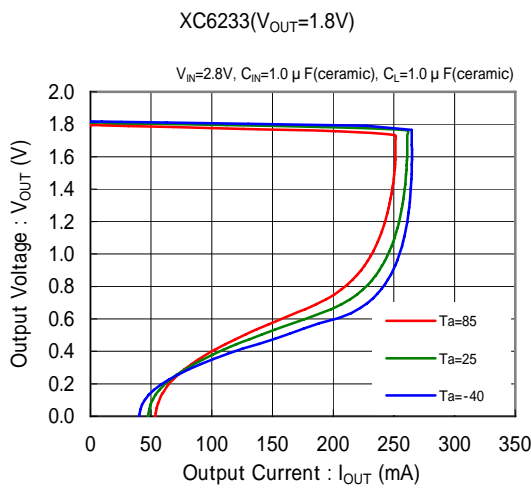
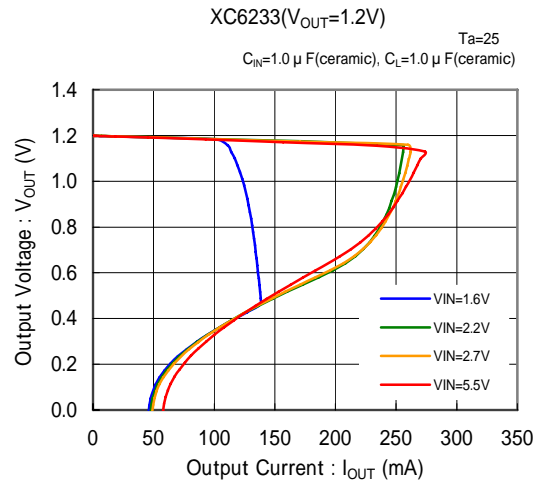
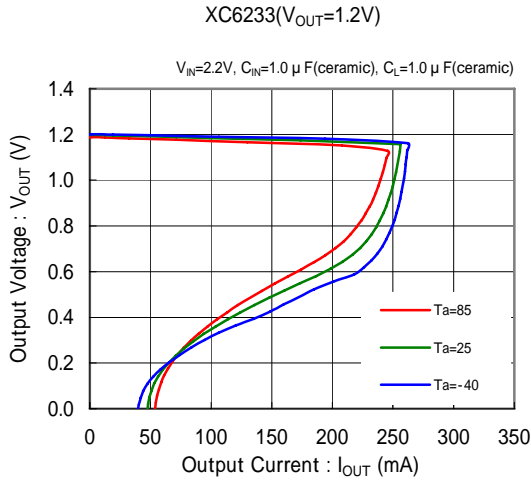

TYPICAL PERFORMANCE CHARACTERISTICS (Continued)

(1) Output Voltage vs. Output Current (Continued)

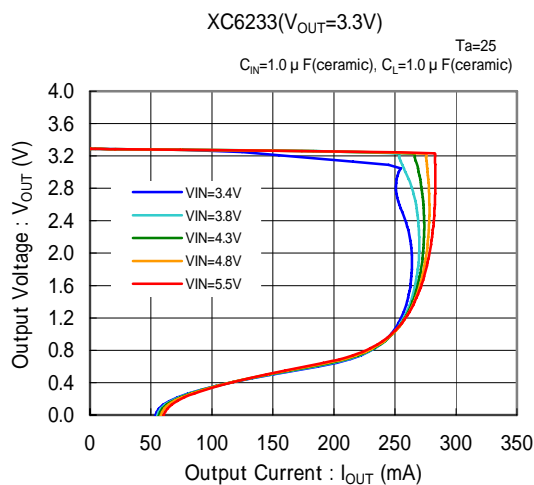
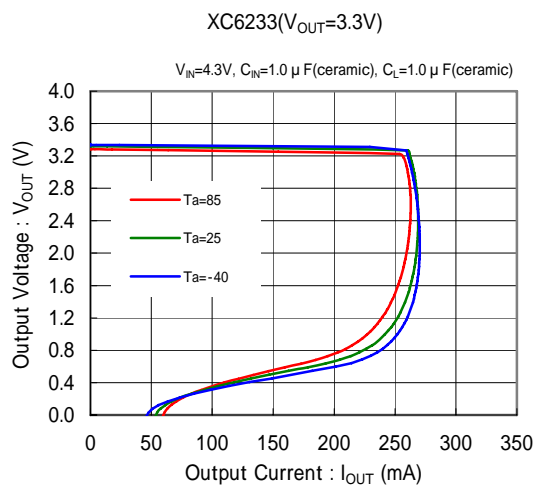

(2) Output Voltage vs. Input Voltage

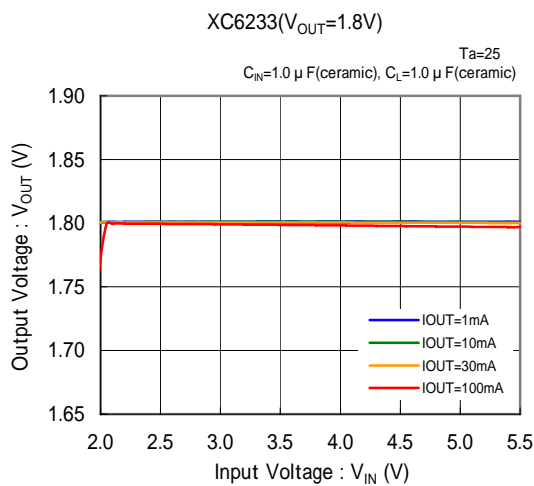
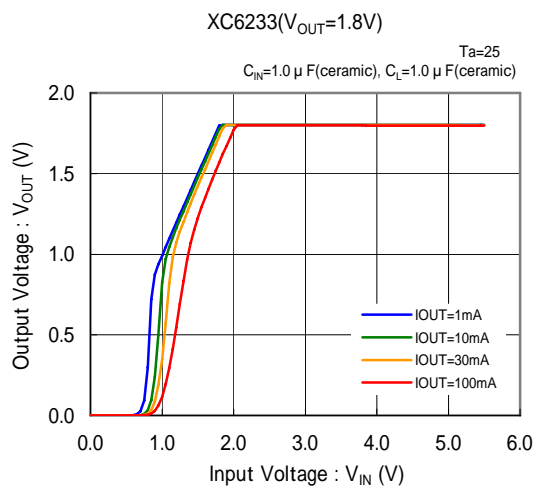
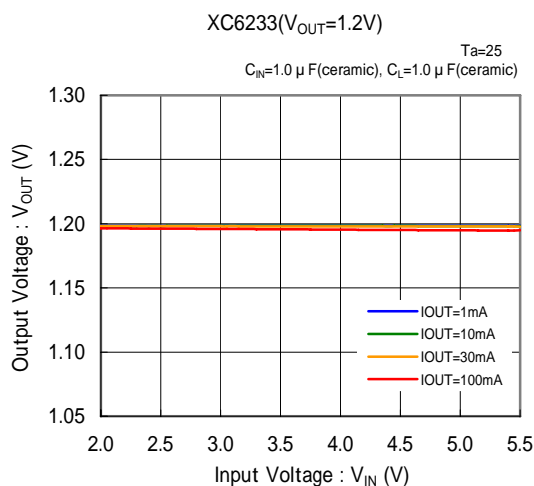
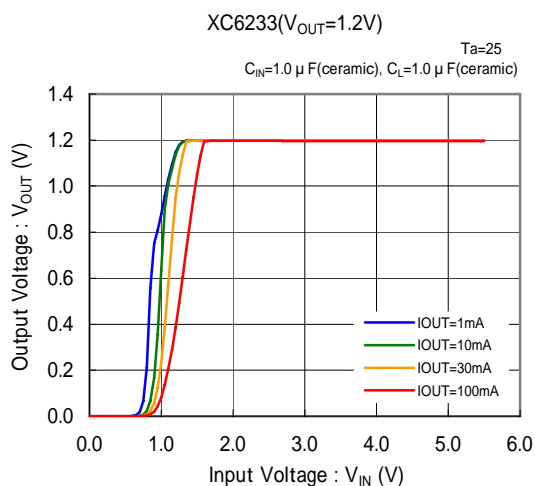

TYPICAL PERFORMANCE CHARACTERISTICS (Continued)

(2) Output Voltage vs. Input Voltage (Continued)

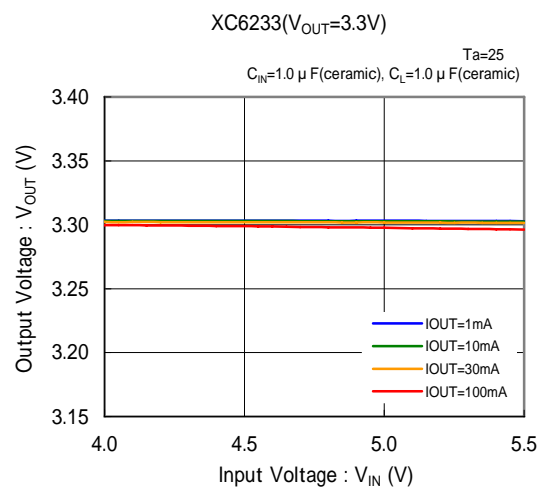
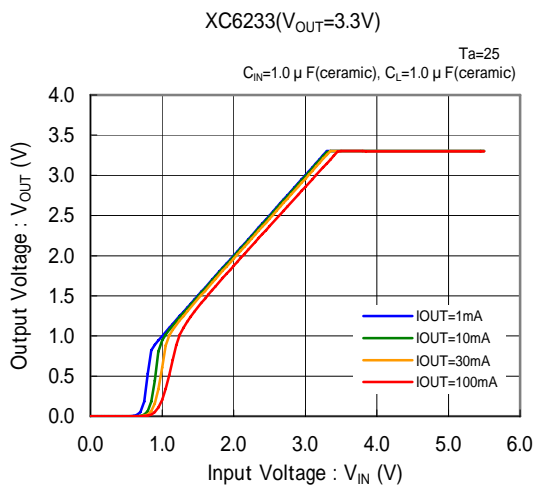
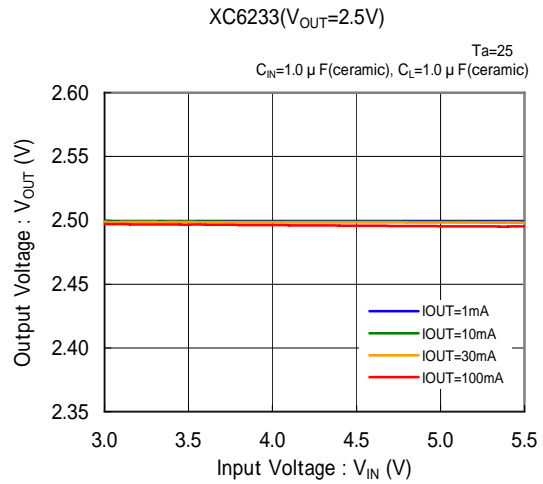
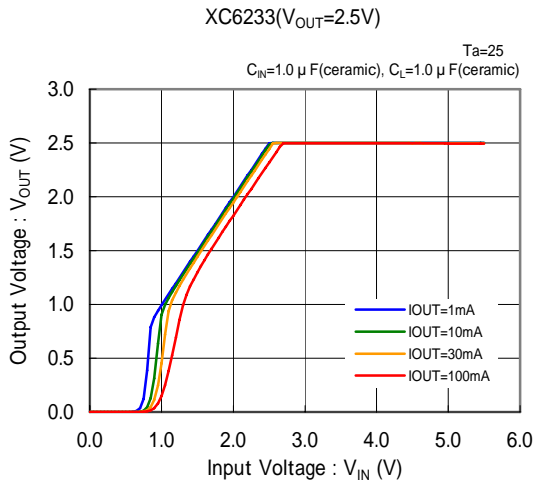

(3) Dropout Voltage vs. Output Current

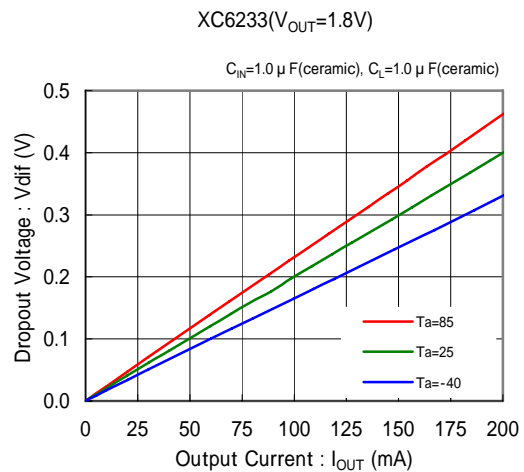
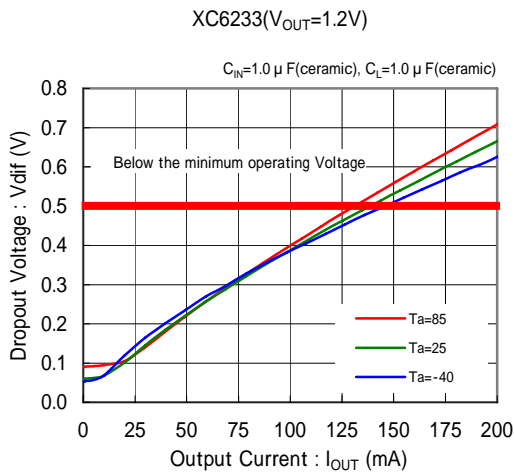

TYPICAL PERFORMANCE CHARACTERISTICS (Continued)

(3) Dropout Voltage vs. Output Current (Continued)

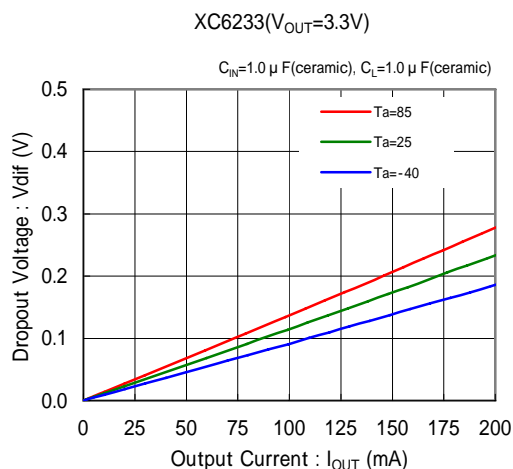
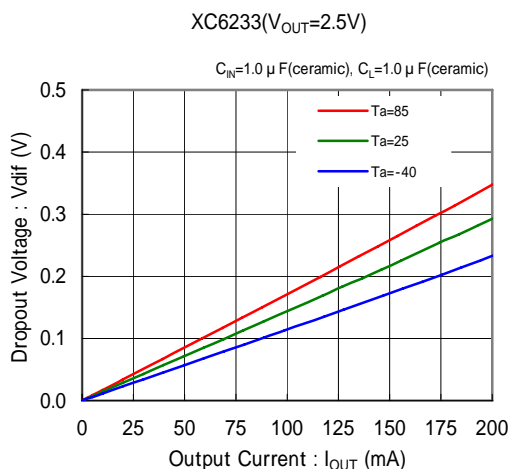

(4) Supply Current vs. Input Voltage

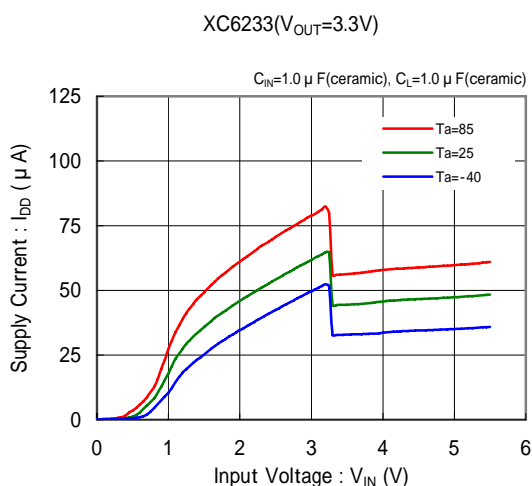
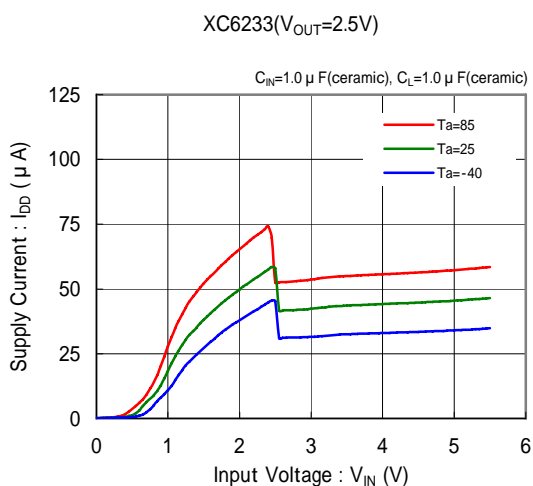
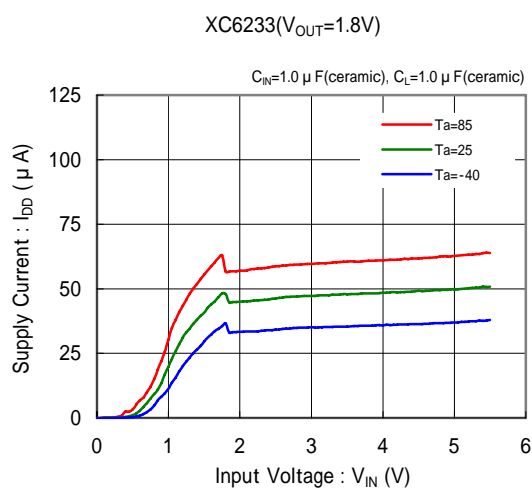
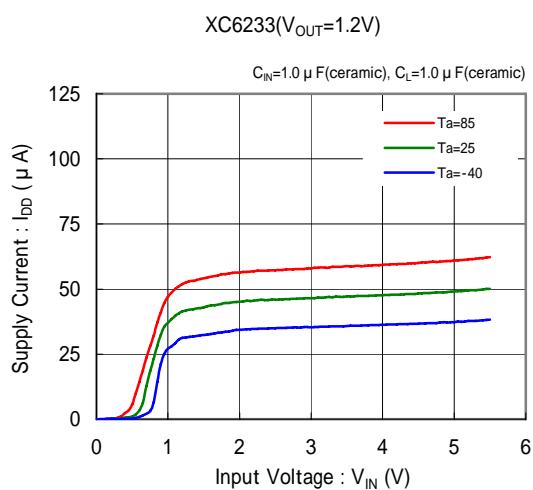

TYPICAL PERFORMANCE CHARACTERISTICS (Continued)

(5) Output Voltage vs. Ambient Temperature

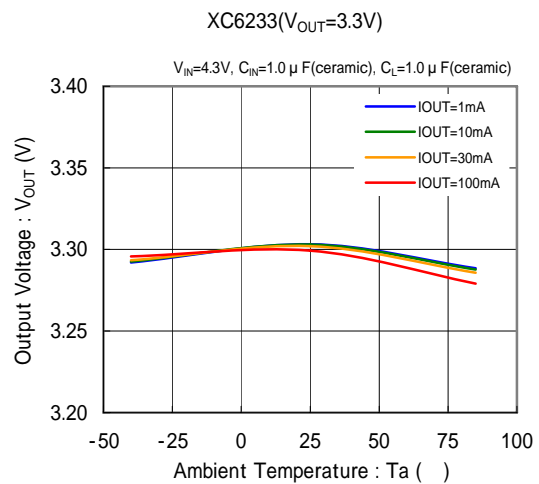
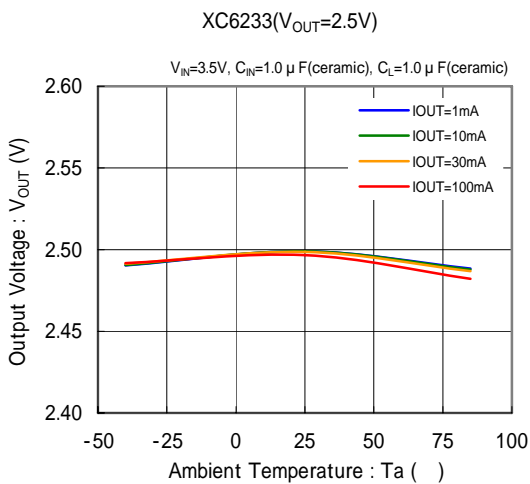
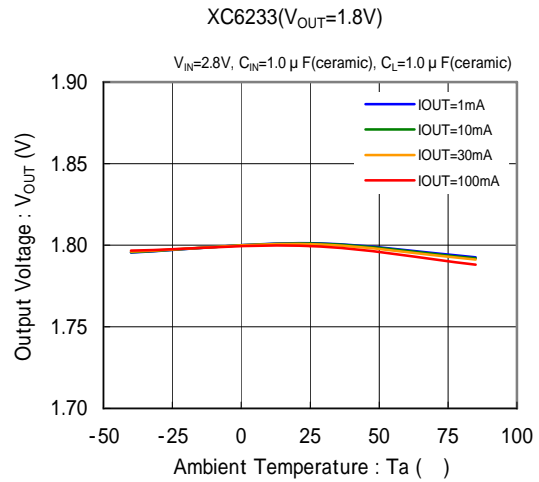
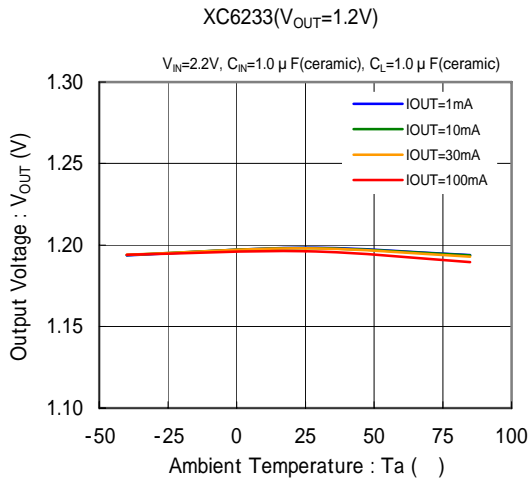

(6) Supply Current vs. Ambient Temperature

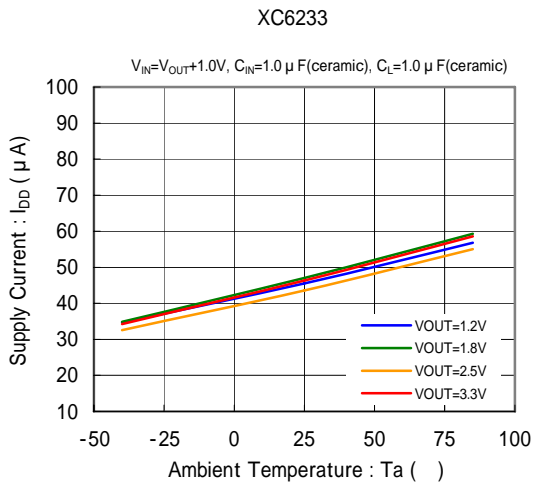

(7) CE Threshold Voltage vs. Ambient Temperature

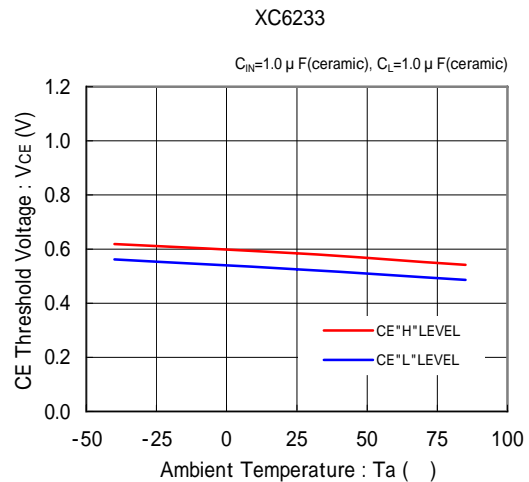

TYPICAL PERFORMANCE CHARACTERISTICS (Continued)

(8) Rising Response Time

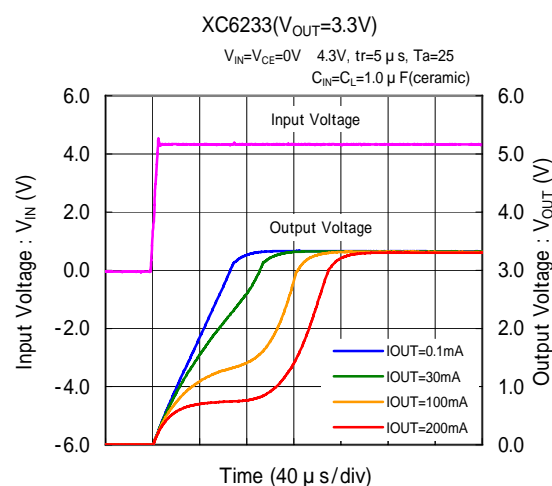
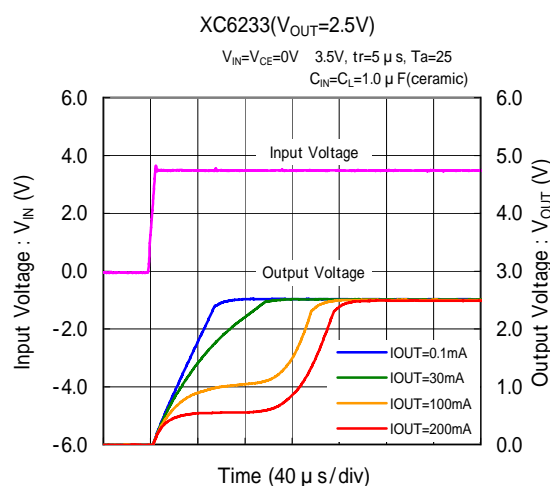
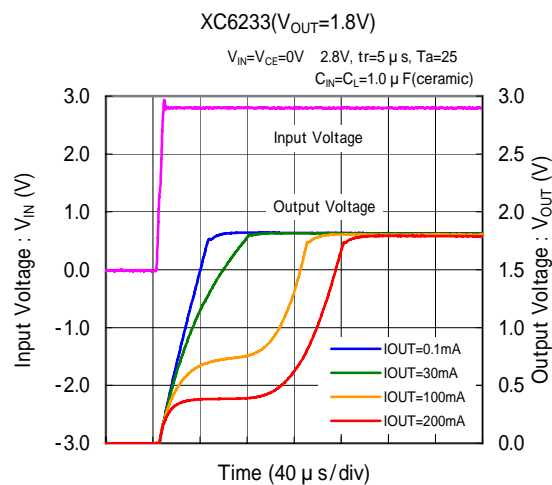
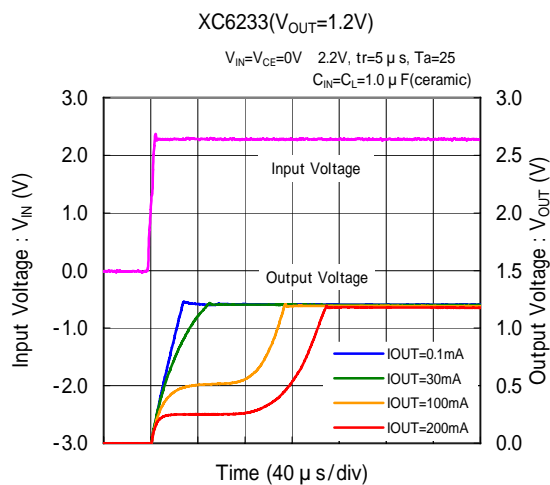

(9) Input Transient Response

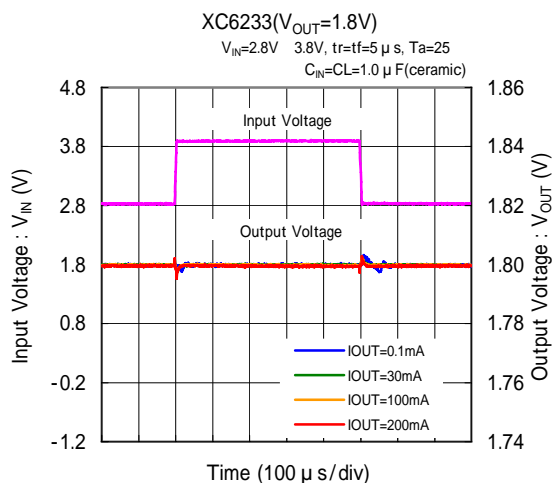
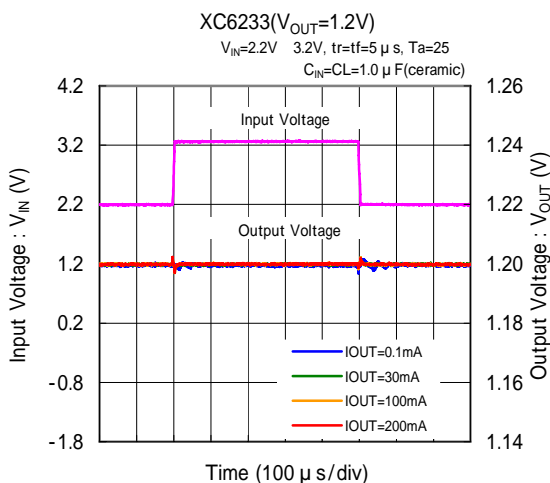

TYPICAL PERFORMANCE CHARACTERISTICS (Continued)

(9) Input Transient Response (Continued)

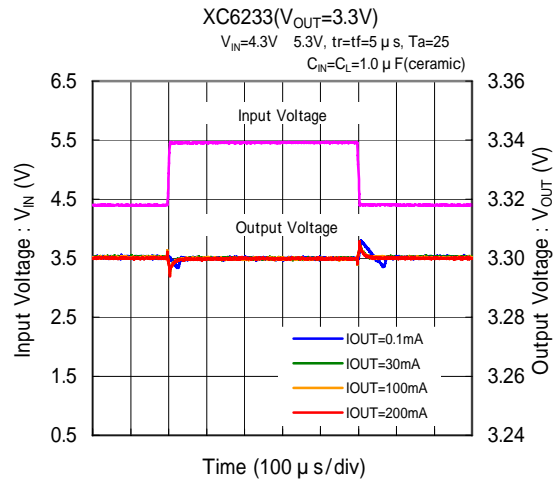
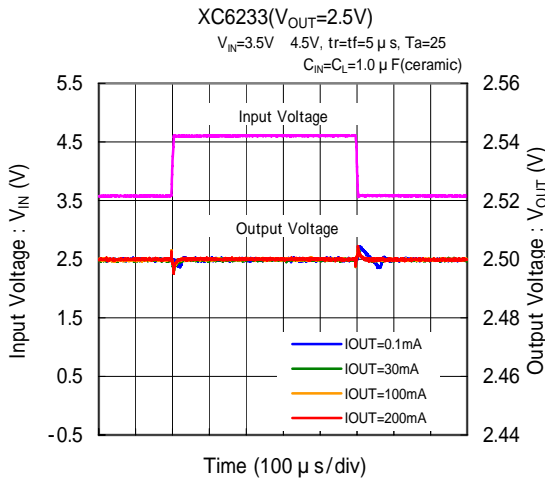

(10) Load Transient Response

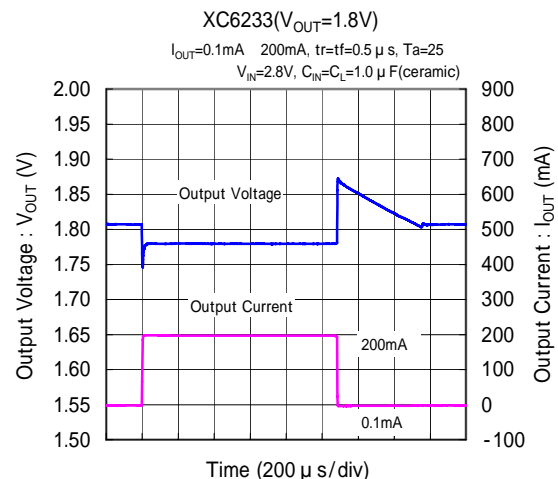
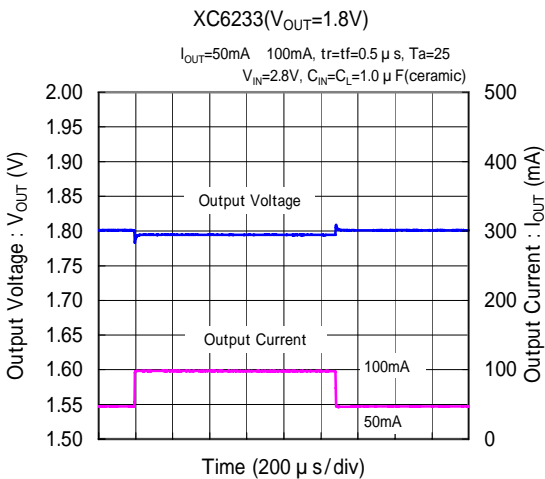
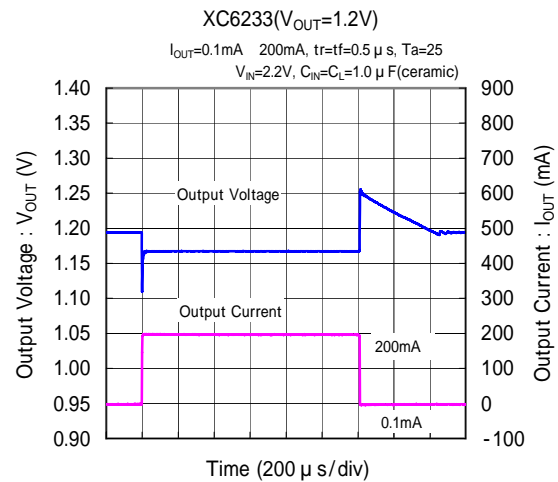
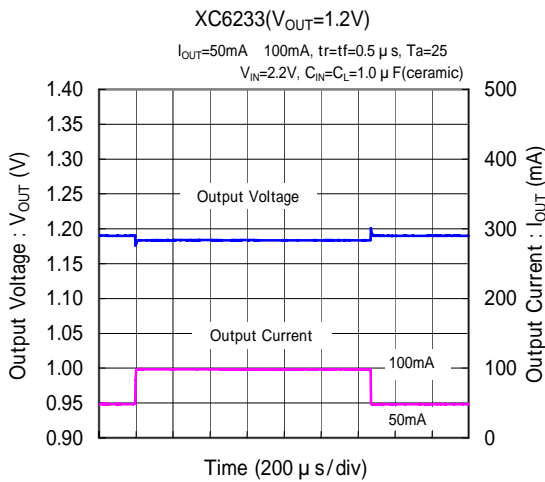

TYPICAL PERFORMANCE CHARACTERISTICS (Continued)

(10) Load Transient Response (Continued)

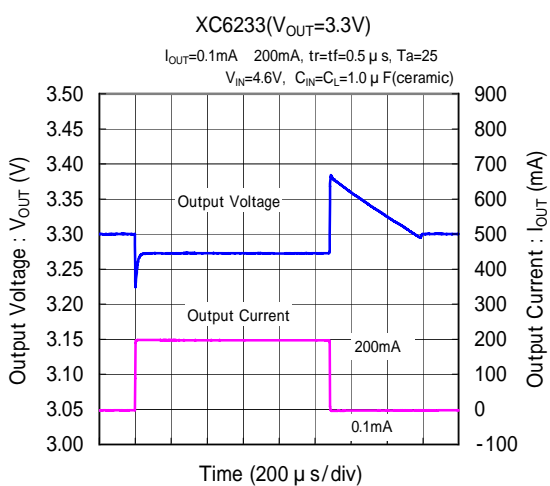
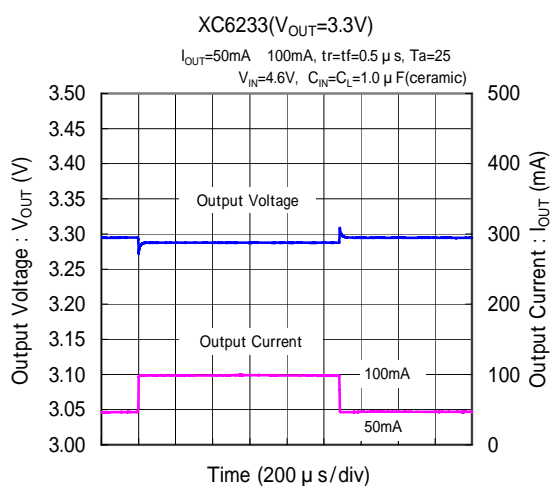
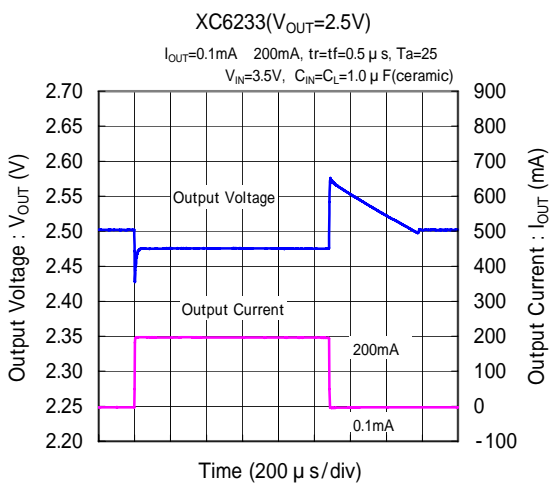
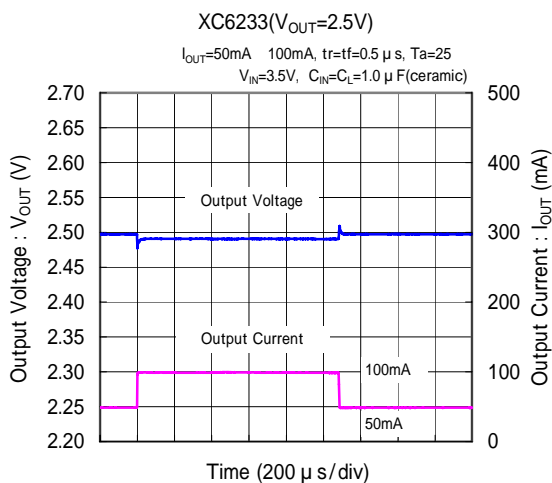

(11) CE Rising Response Time

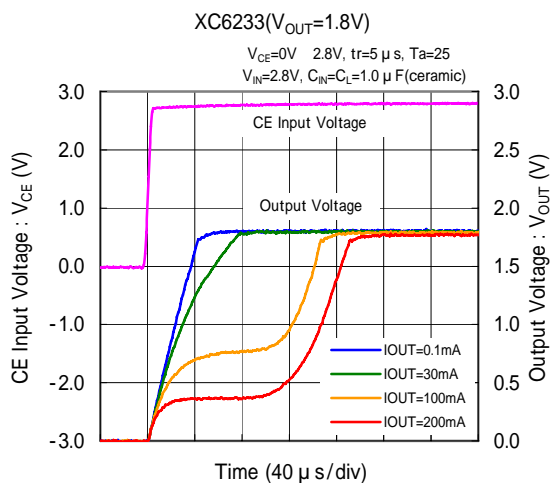
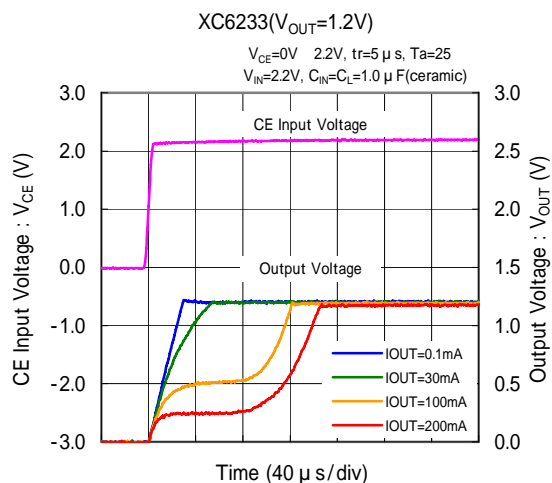

TYPICAL PERFORMANCE CHARACTERISTICS (Continued)

(11) CE Rising Response Time (Continued)

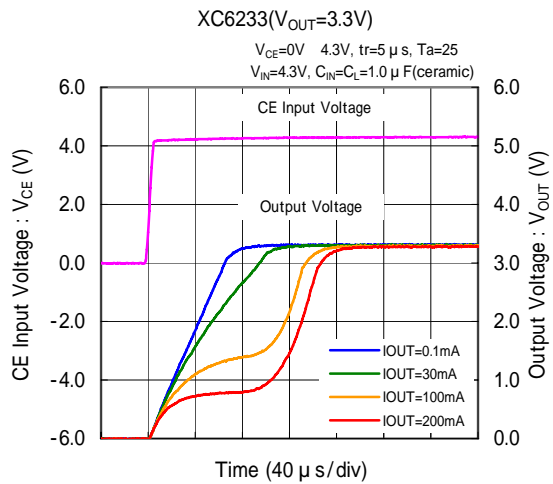
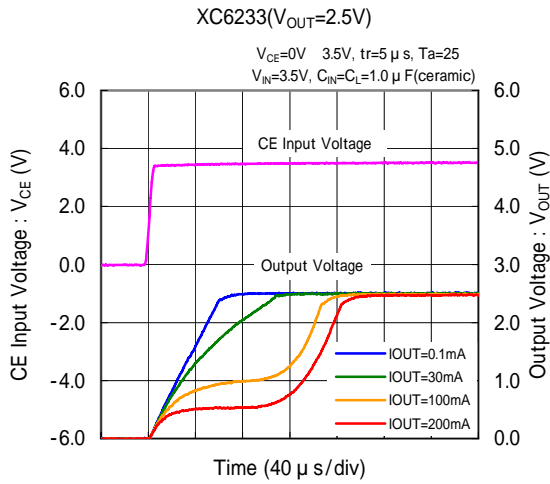

(12) Power Supply Rejection Ratio

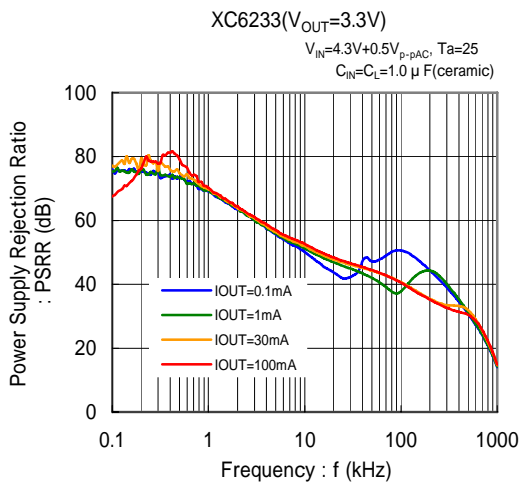
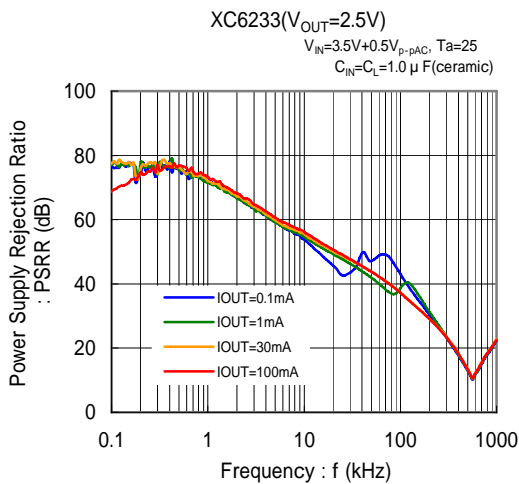
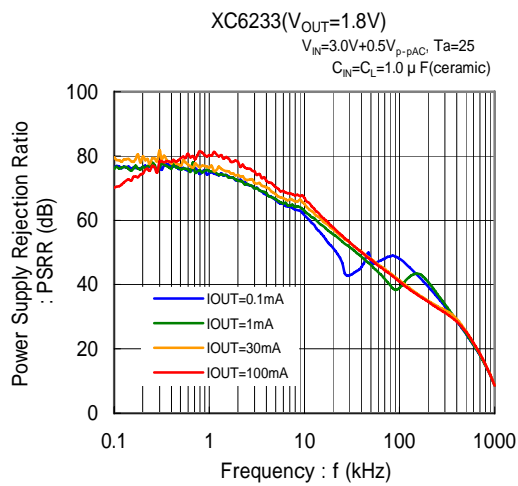
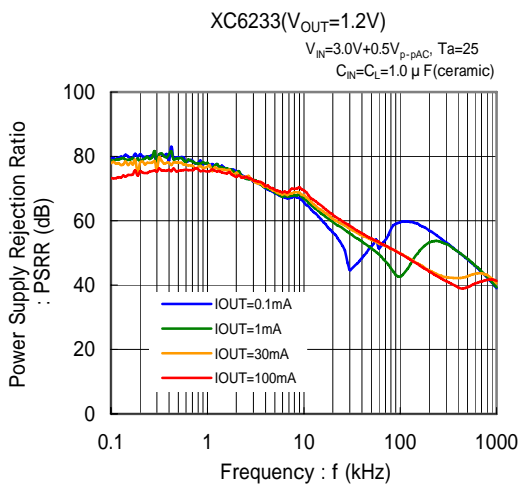

TYPICAL PERFORMANCE CHARACTERISTICS (Continued)

(13) Inrush Current Response

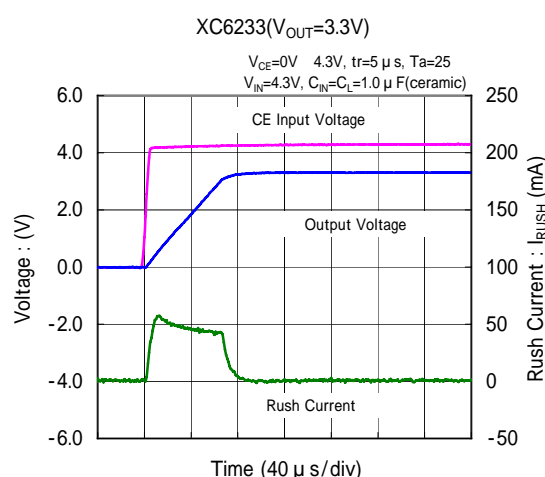
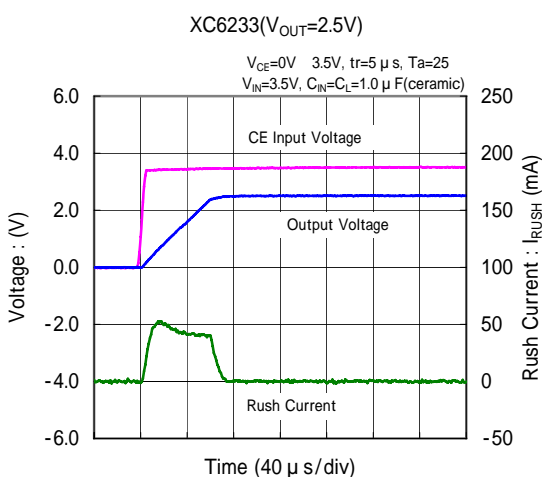
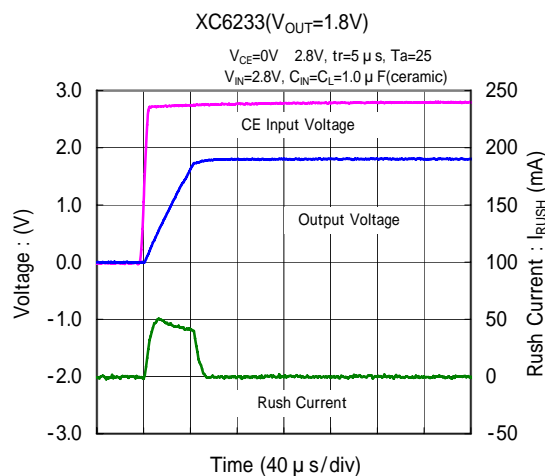
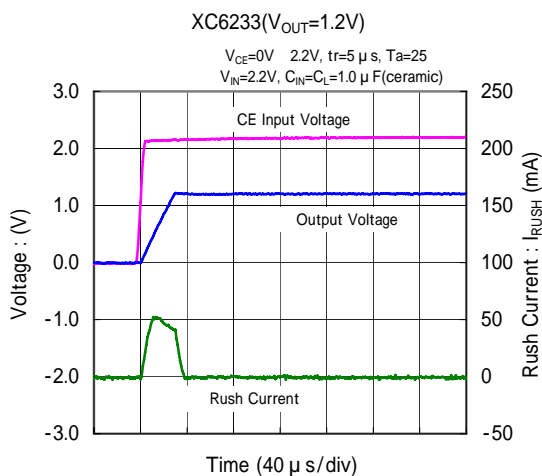

(14) Output Noise Density

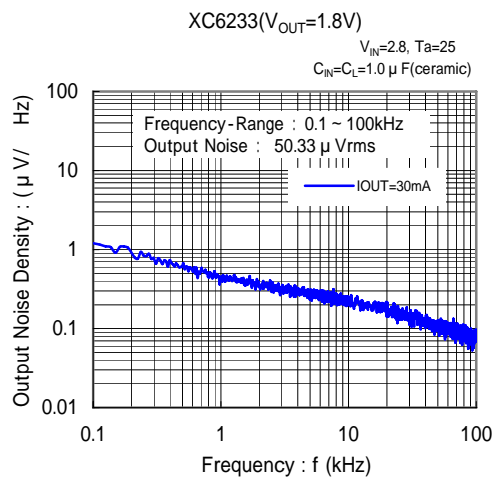
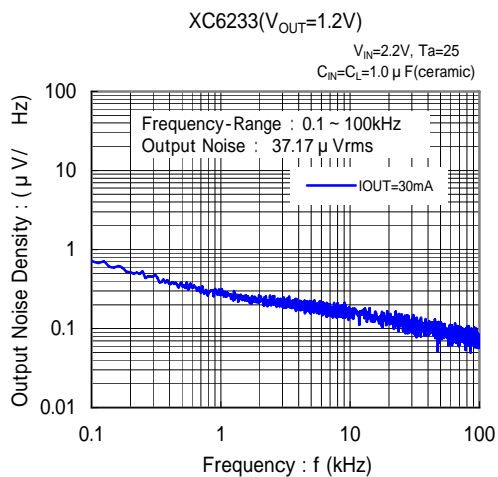

TYPICAL PERFORMANCE CHARACTERISTICS (Continued)

(14) Output Noise Density (Continued)

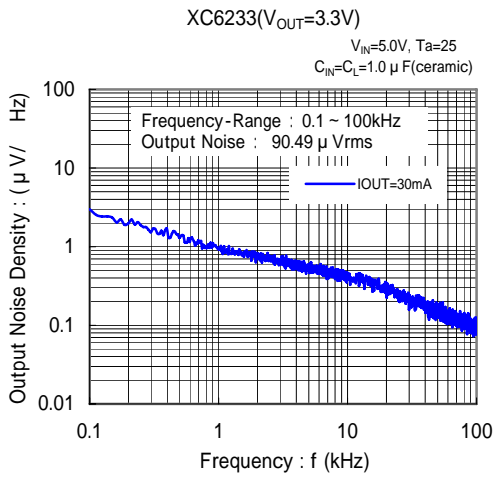

PACKAGING INFORMATION

● USPQ-4B04 (unit:mm)

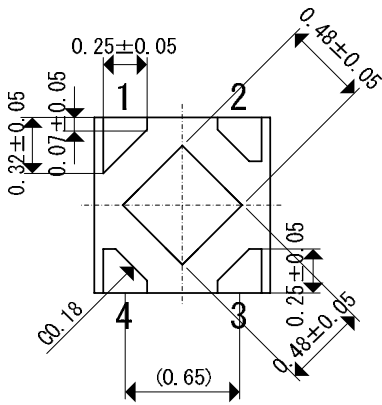
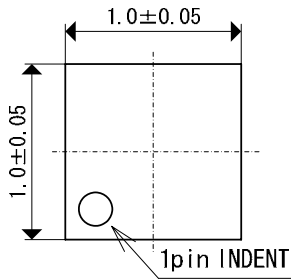

USPQ-4B04 Reference Pattern Layout (unit: mm)

USPQ-4B04 Reference Metal Mask Design (unit: mm)

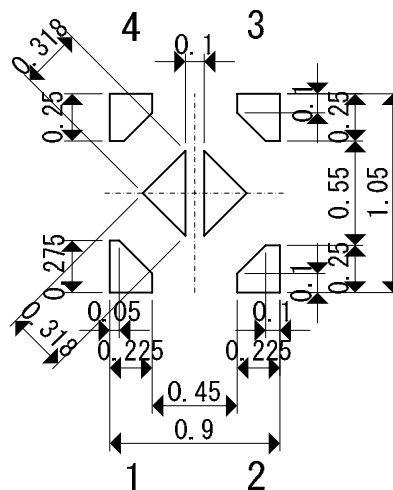
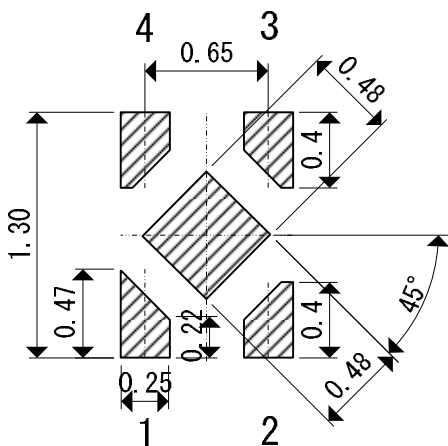

PACKAGING INFORMATION (Continued)

USP-4 (unit: mm)

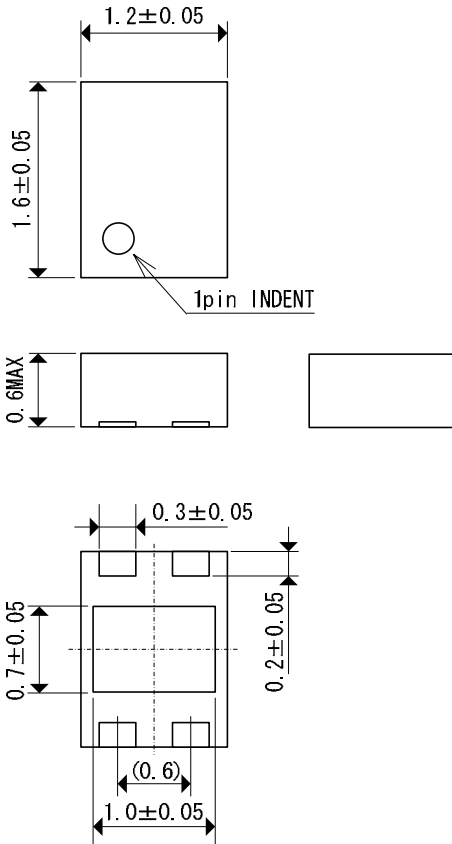

USP-4 Reference Pattern Layout (unit: mm)

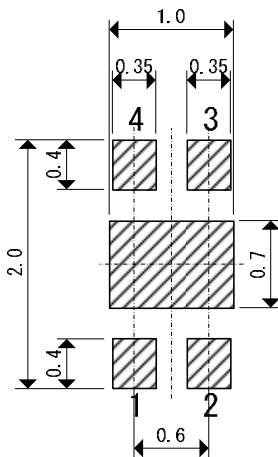

USP-4 Reference Metal Mask Design (unit: mm)

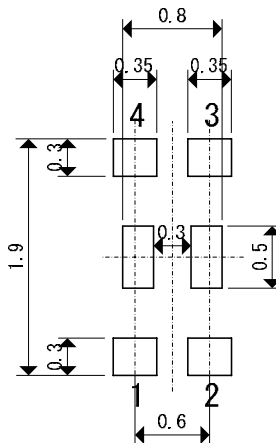

PACKAGING INFORMATION (Continued)

SSOT-24 (unit: mm)

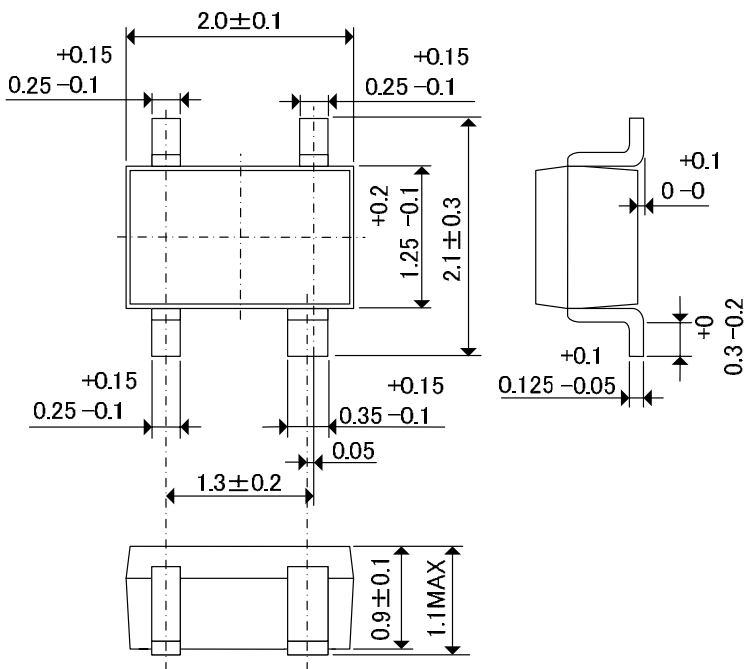

SOT-25 (unit: mm)

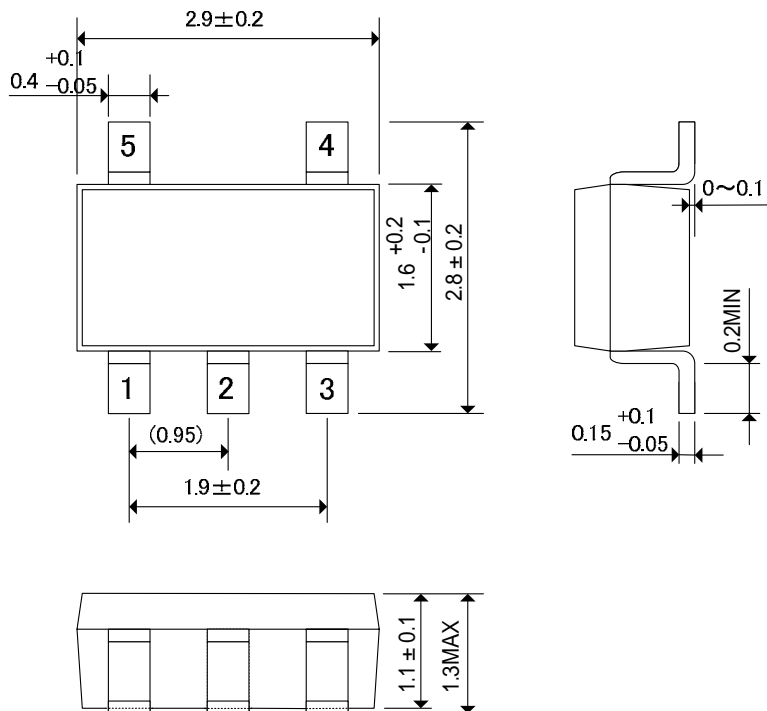

USPQ-4B04 Power Dissipation

Power dissipation data for the USPQ-4B04 is shown in this page.
 The value of power dissipation varies with the mount board conditions.
 Please use this data as the reference data taken in the following condition.

1. Measurement Condition

- Condition : Mount on a board
- Ambient : Natural convection
- Soldering : Lead (Pb) free
- Board Dimensions : 40 x 40 mm (1600mm²)
- Board Structure : 4 Copper Layers
 - Each layer is connected to the package heat-sink and terminal pin No.1.
 - Each layer has approximately 800mm² copper area.
- Material : Glass Epoxy (FR-4)
- Thickness : 1.6 mm
- Through-hole : 4 x 0.8 Diameter

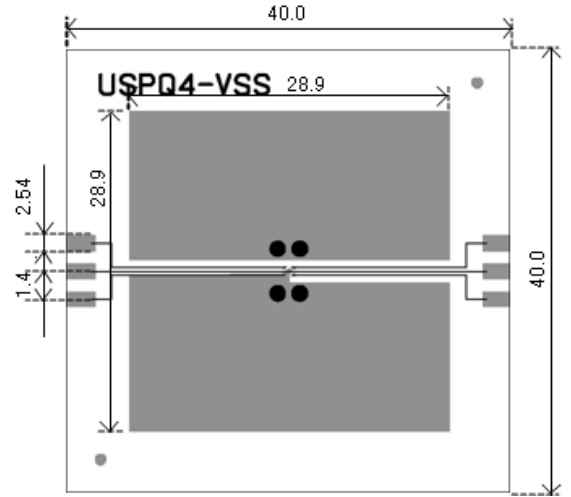

Evaluation Board (Unit: mm)

2. Power Dissipation vs. Ambient Temperature

Board Mount (T_j max = 125 °C)

Ambient Temperature (°C)	Power Dissipation Pd (mW)	Thermal Resistance (°C /W)
25	550	181.82
85	220	

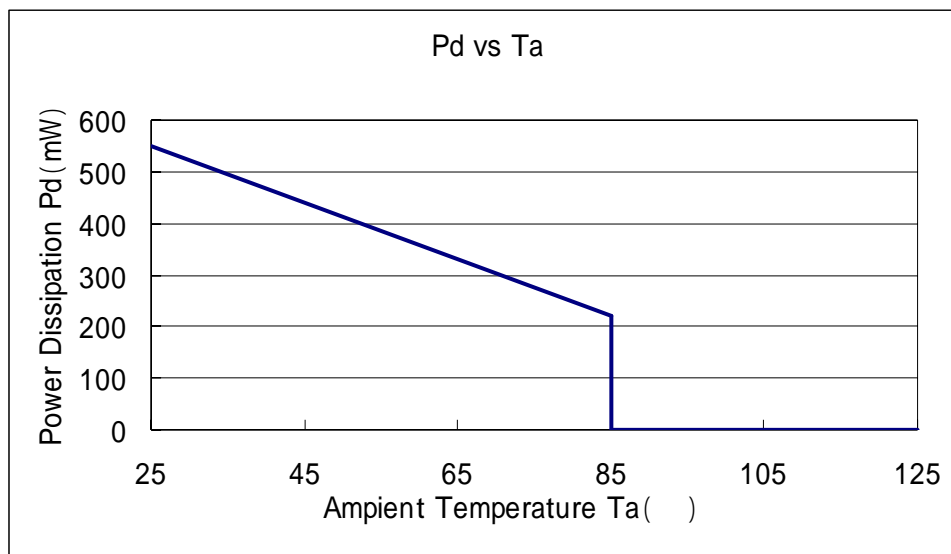

USP-4 Power Dissipation

Power dissipation data for the USP-4 is shown in this page.
The value of power dissipation varies with the mount board conditions.
Please use this data as the reference data taken in the following condition.

1. Measurement Condition

- Condition: Mount on a board
- Ambient: Natural convection
- Soldering: Lead (Pb) free
- Board: Dimensions 40 x 40 mm (1600mm² in one side)
Copper (Cu) traces occupy 50% of the board area
In top and back faces
Package heat-sink is tied to the copper traces
- Material: Glass Epoxy (FR-4)
- Thickness: 1.6 mm
- Through-hole: 4 x 0.8 Diameter

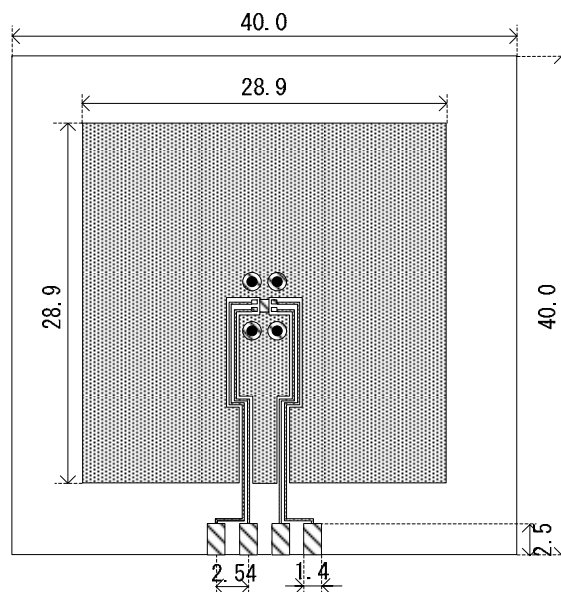

Evaluation Board (Unit: mm)

2. Power Dissipation vs. Ambient Temperature

Board Mount (T_{jmax}=125 °C)

Ambient Temperature (°C)	Power Dissipation Pd (mW)	Thermal Resistance (°C/W)
25	1000	100.00
85	400	

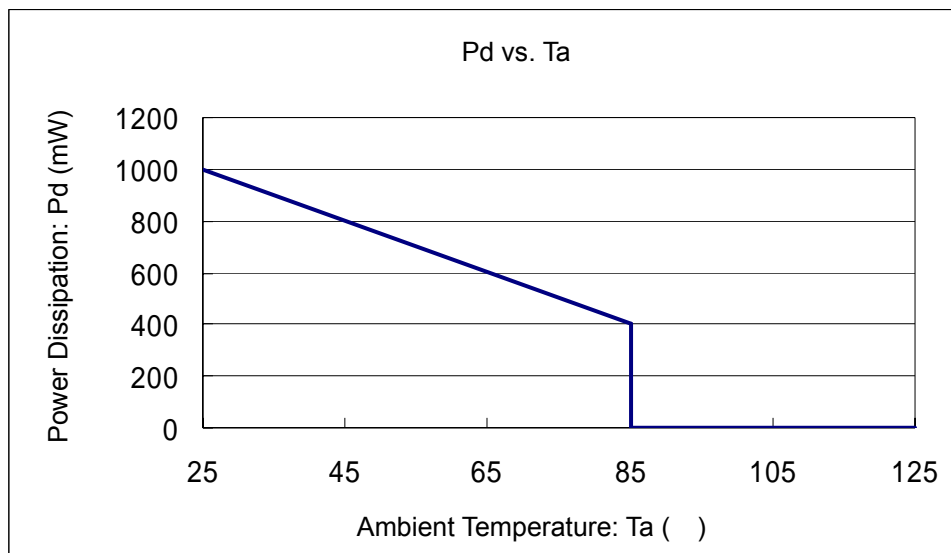

SSOT-24 Power Dissipation

Power dissipation data for the SSOT-24 is shown in this page.
 The value of power dissipation varies with the mount board conditions.
 Please use this data as the reference data taken in the following condition.

1. Measurement Condition

- Condition: Mount on a board
- Ambient: Natural convection
- Soldering: Lead (Pb) free
- Board: Dimensions 40 x 40mm (1600mm² in one side)
 Copper (Cu) traces occupy 50% of the board area
 In top and back faces
 Package heat-sink is tied to the copper traces
- Material: Glass Epoxy (FR-4)
- Thickness: 1.6mm
- Through-hole: 4 x 0.8 Diameter

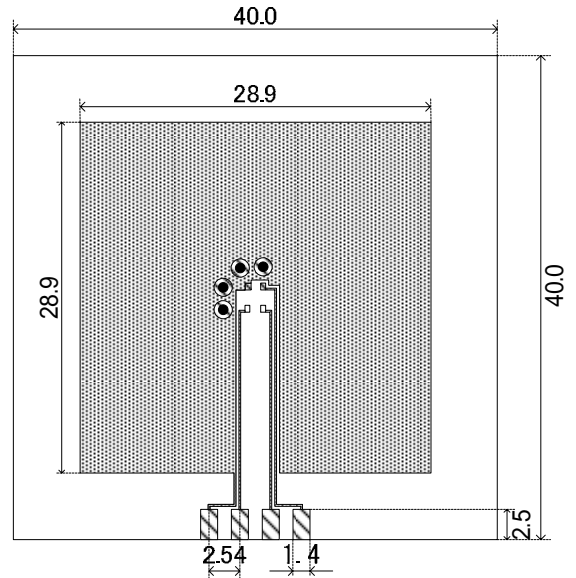

2. Power Dissipation vs. Ambient Temperature

Board Mount (T_{jmax}=125 °C)

Ambient Temperature (°C)	Power Dissipation Pd (mW)	Thermal Resistance (°C/W)
25	500	200.00
85	200	

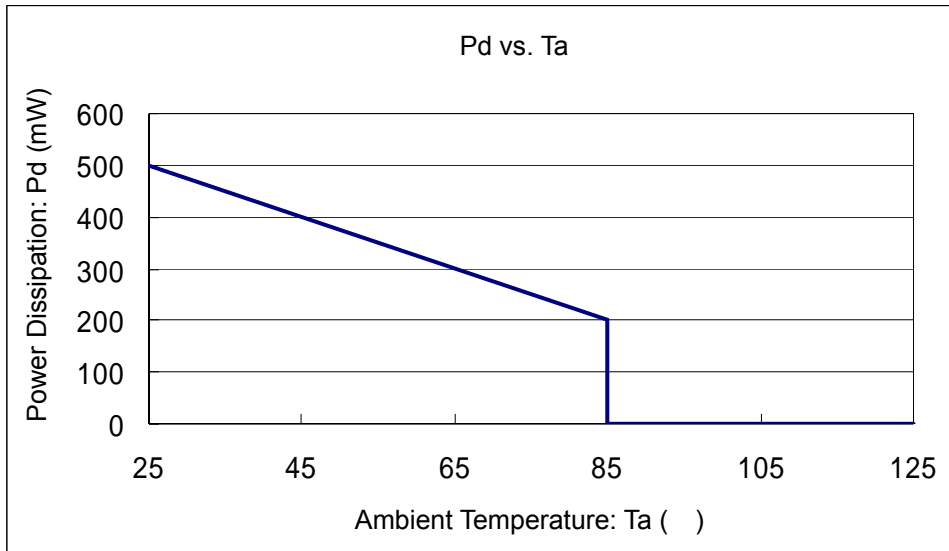

SOT-25 Power Dissipation

Power dissipation data for the SOT-25 is shown in this page.

The value of power dissipation varies with the mount board conditions.

Please use this data as the reference data taken in the following condition.

1. Measurement Condition

- Condition: Mount on a board
- Ambient: Natural convection
- Soldering: Lead (Pb) free
- Board: Dimensions 40 × 40mm (1600mm² in one side)
Copper (Cu) traces occupy 50% of the board area
In top and back faces
Package heat-sink is tied to the copper traces
(Board of SOT-26 is used)
- Material: Glass Epoxy (FR-4)
- Thickness: 1.6mm
- Through-hole: 4 × 0.8 Diameter

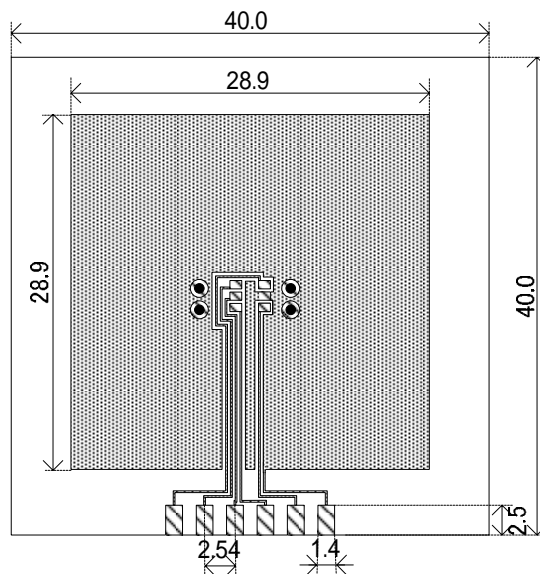

Evaluation Board (Unit: mm)

2. Power Dissipation vs. Ambient Temperature

Board Mount (T_{jmax}=125 °C)

Ambient Temperature (°C)	Power Dissipation Pd (mW)	Thermal Resistance (°C/W)
25	600	166.67
85	240	

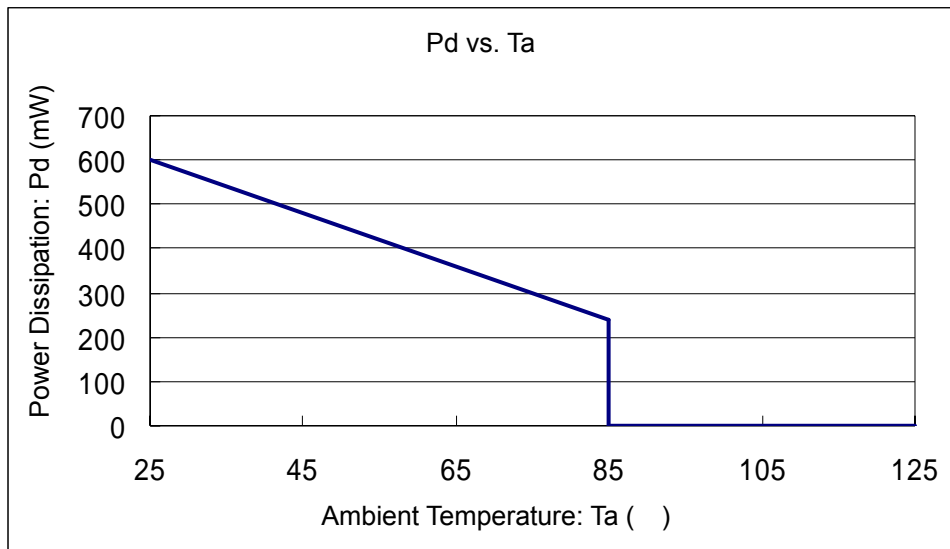

MARKING RULE

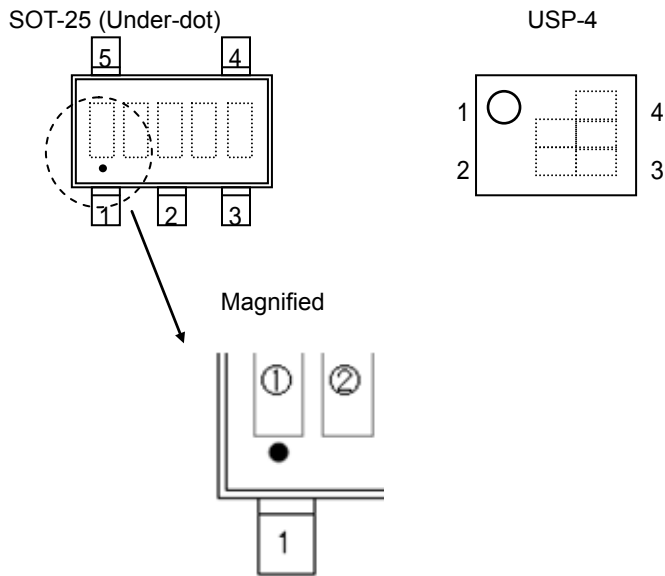

* SOT-25 with the under-dot marking is used.

represents products series

MARK	PRODUCT SERIES
1	XC6233*****-G

represents type of regulator

MARK		PRODUCT SERIES
OUTPUT VOLTAGE 0.1V Increments	OUTPUT VOLTAGE 0.05V Increments	
K	M	XC6233H*****-G

represents output voltage

MARK	OUTPUT VOLTAGE (V)		MARK	OUTPUT VOLTAGE (V)	
0	1.2	1.25	F	2.7	2.75
1	1.3	1.35	H	2.8	2.85
2	1.4	1.45	K	2.9	2.95
3	1.5	1.55	L	3.0	3.05
4	1.6	1.65	M	3.1	3.15
5	1.7	1.75	N	3.2	3.25
6	1.8	1.85	P	3.3	3.35
7	1.9	1.95	R	3.4	3.45
8	2.0	2.05	S	3.5	3.55
9	2.1	2.15	T	3.6	-
A	2.2	2.25	U	-	-
B	2.3	2.35	V	-	-
C	2.4	2.45	X	-	-
D	2.5	2.55	Y	-	-
E	2.6	2.65	Z	-	-

, represents production lot number

01 ~ 09, 0A ~ 0Z, 11 ~ 9Z, A1 ~ A9, AA ~ AZ, B1 ~ ZZ in order.

(G, I, J, O, Q, W excluded)

*No character inversion used.

MARKING RULE (Continued)

SSOT-24 (With the orientation bar at the top)

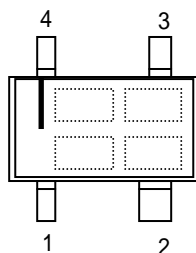

USPQ-4B04

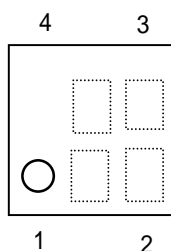

(XC6233*****-G with the orientation bar at the top is used.)

represents products series, type of regulator and output voltage

MARK	OUTPUT VOLTAGE (V)	CURRENT LIMITER	CE PULL-DOWN RESISTOR	C _L AUTO DISCHARGE	INRUSH CURRENT PREVENTION	PRODUCT SERIES
A	1.2 ~ 2.0	Yes	Yes	Yes	Yes	XC6233H121**-G ~ XC6233H201**-G
B	2.1 ~ 2.9	Yes	Yes	Yes	Yes	XC6233H211**-G ~ XC6233H291**-G
C	3.0 ~ 3.6	Yes	Yes	Yes	Yes	XC6233H301**-G ~ XC6233H361**-G
D	1.25 ~ 2.05	Yes	Yes	Yes	Yes	XC6233H12B**-G ~ XC6233H20B**-G
E	2.15 ~ 2.95	Yes	Yes	Yes	Yes	XC6233H21B**-G ~ XC6233H29B**-G
F	3.05 ~ 3.55	Yes	Yes	Yes	Yes	XC6233H30B**-G ~ XC6233H35B**-G

represents output voltage

MARK	OUTPUT VOLTAGE (V)					
1	1.2	2.1	3.0	1.25	2.15	3.05
2	1.3	2.2	3.1	1.35	2.25	3.15
3	1.4	2.3	3.2	1.45	2.35	3.25
4	1.5	2.4	3.3	1.55	2.45	3.35
5	1.6	2.5	3.4	1.65	2.55	3.45
6	1.7	2.6	3.5	1.75	2.65	3.55
7	1.8	2.7	3.6	1.85	2.75	
8	1.9	2.8		1.95	2.85	
9	2.0	2.9		2.05	2.95	

, represents production lot number

01 ~ 09, 0A ~ 0Z, 11 ~ 9Z, A1 ~ A9, AA ~ AZ, B1 ~ ZZ in order.

(G, I, J, O, Q, W excluded)

*No character inversion used.

1. The products and product specifications contained herein are subject to change without notice to improve performance characteristics. Consult us, or our representatives before use, to confirm that the information in this datasheet is up to date.
2. We assume no responsibility for any infringement of patents, patent rights, or other rights arising from the use of any information and circuitry in this datasheet.
3. Please ensure suitable shipping controls (including fail-safe designs and aging protection) are in force for equipment employing products listed in this datasheet.
4. The products in this datasheet are not developed, designed, or approved for use with such equipment whose failure or malfunction can be reasonably expected to directly endanger the life of, or cause significant injury to, the user.
(e.g. Atomic energy; aerospace; transport; combustion and associated safety equipment thereof.)
5. Please use the products listed in this datasheet within the specified ranges.
Should you wish to use the products under conditions exceeding the specifications, please consult us or our representatives.
6. We assume no responsibility for damage or loss due to abnormal use.
7. All rights reserved. No part of this datasheet may be copied or reproduced without the prior permission of TOREX SEMICONDUCTOR LTD.

TOREX SEMICONDUCTOR LTD.

单击下面可查看定价，库存，交付和生命周期等信息

[>>Torex Semiconductor\(特瑞仕\)](#)