



# ***har-flex***<sup>®</sup>

## ***Flexible connectivity solutions***

# har-flex® - Flexible Connectivity Solutions



Pushing Performance

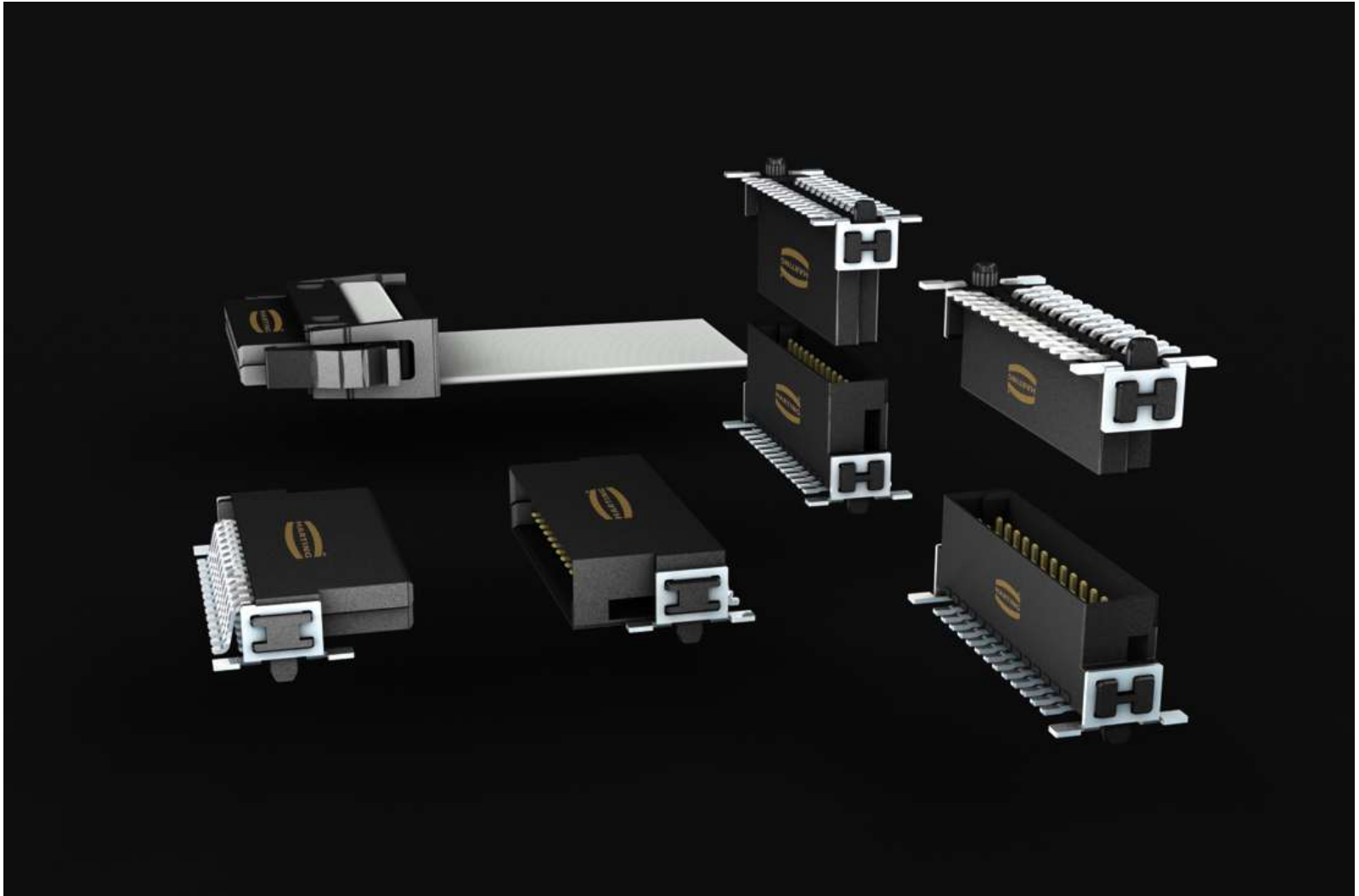

## ***Value Proposition***

*We are your technology partner in a wide range of applications for variety of diverse markets including industrial, medical, telecom, transportation, defense and broadcast.*

*Providing solutions is our key differentiator. In addition to standardized products we excel in customized variants – tailored to individual customer needs.*

*We are committed to providing innovative solutions and quality you can trust*

- Introduction to *har-flex*<sup>®</sup>
- *har-flex*<sup>®</sup> connector range
- Status today
- Marketing material
- Competitor Snapshot
- Logistics information
- Summary



# Introduction to *har-flex*®

# HARTING DC 1 Connectivity



Pushing Performance

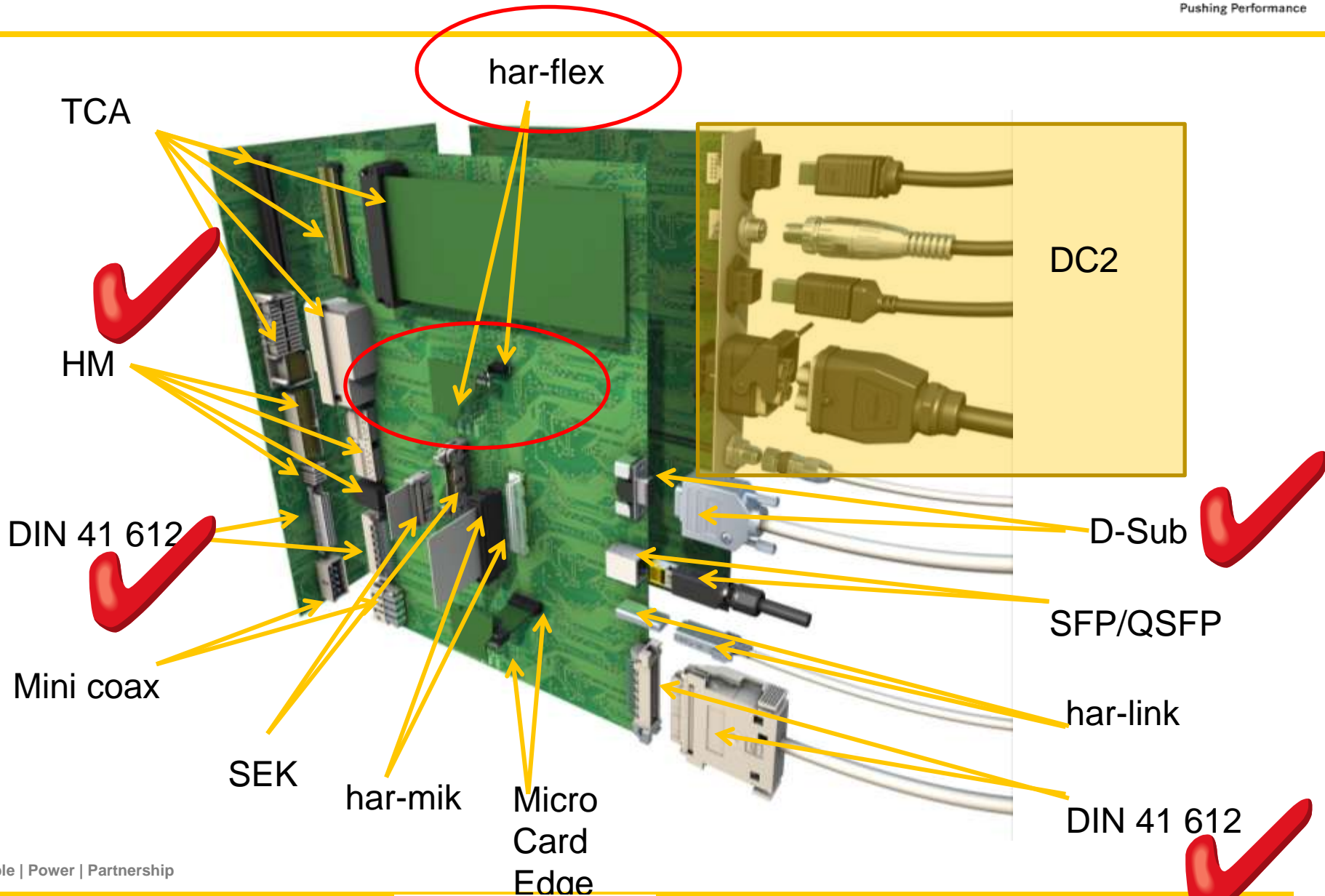

# Connectivity levels



Pushing Performance

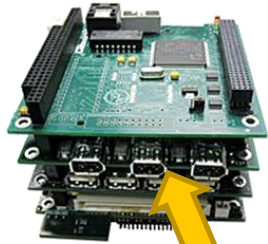

Board to board straight

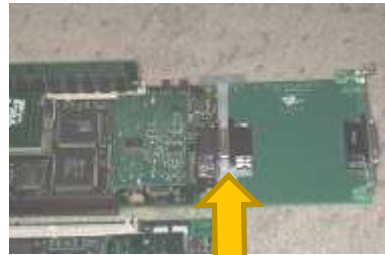
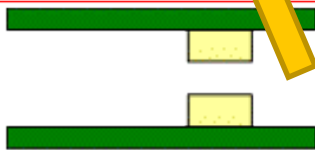

Board to board right angled



Cable to Board - I/O

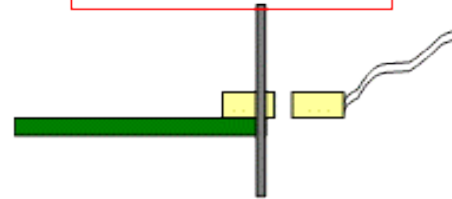

Backplane to daughter card



Wire to board - Inside

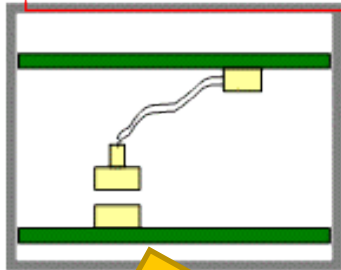

Box to Box - I/O

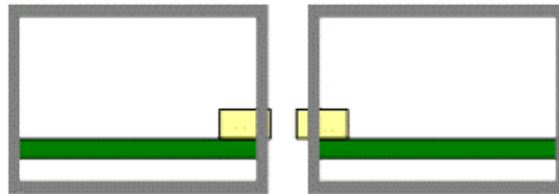

Cable to Cable

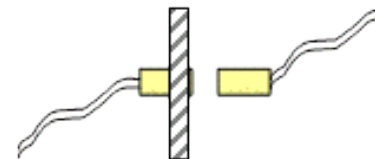

Board to board angled to straight



# har-flex® at a Glance



Pushing Performance

Past

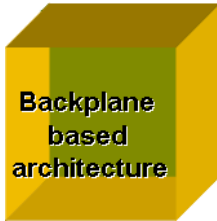

Backplane based architecture

Future



Box architecture

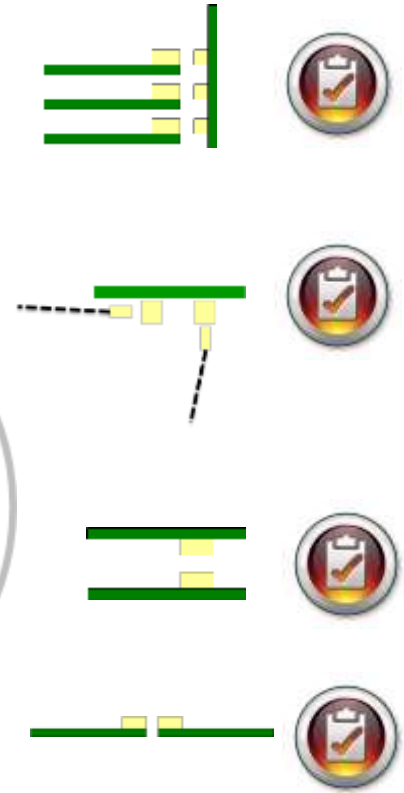
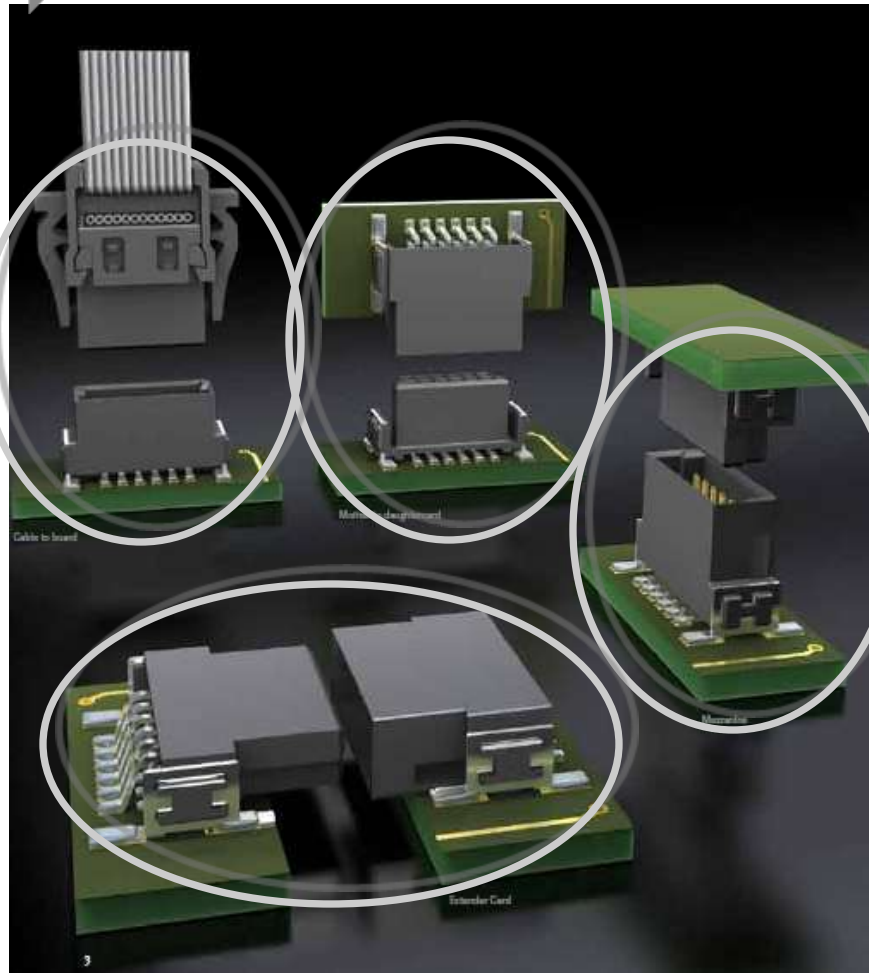



## Mega Trends and “Solution Selling”

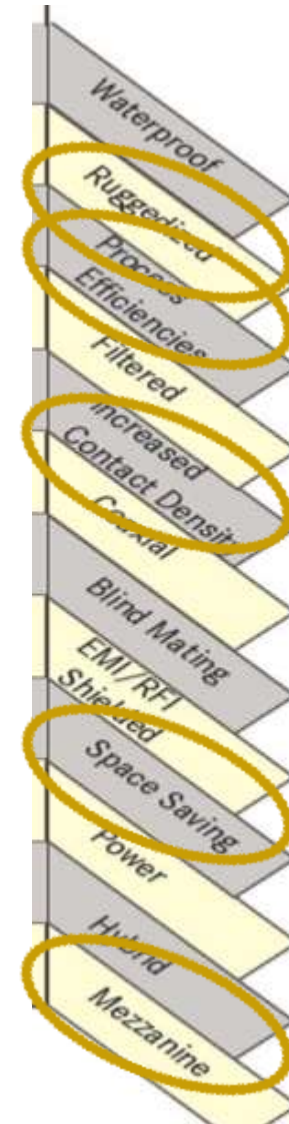
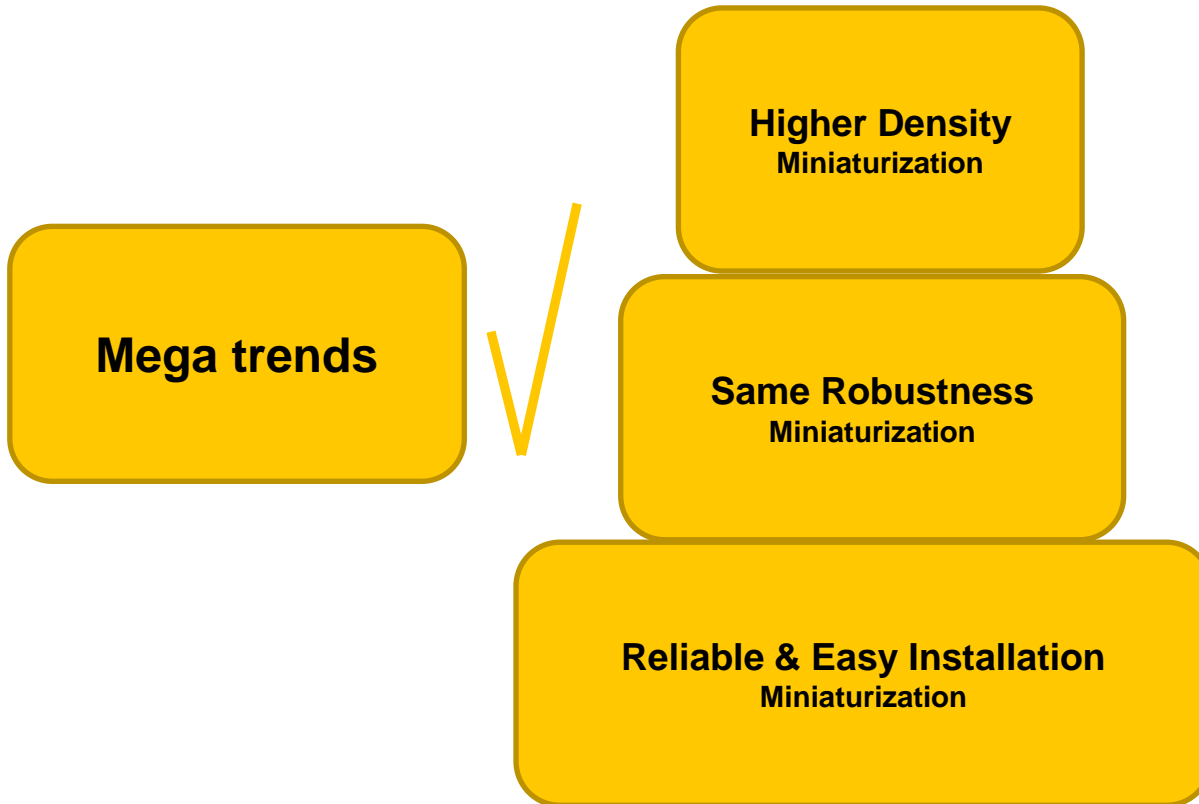

**har-flex<sup>®</sup> addresses 5 of our 12 “solution selling” goals**

## Key factors for developing har-flex<sup>®</sup>

- Box architectures
  - Trend of applications to change hardware architecture from backplane/daughter card style to box architecture
  - Less backplanes needed
  - Trend toward mezzanine solutions
- Miniaturization
  - Smaller components, but still robust
- Surface Mount Technology
  - Users want to have only one work step
  - Fully automated production with pick-and-place machines
  - Surface Mount solder Technology



# Why Mezzanine?



Pushing Performance

“Demand for greater design and expansion flexibility has given rise to mezzanine card architecture, where the mezzanine card stacks directly above the host board and is electrically connected — and often mechanically supported — by the mezzanine connector. The mezzanine card becomes an optional extension of the daughtercard.

The ability to design a system with enough flexibility to customize the product using standard host daughtercards and plug-in modules is highly desirable. Mezzanine cards can also provide a low-cost strategy to address machine obsolescence or the need to expand capacity.”



**Source: Bishop & Associates**

**Research Report P-606-10**

**February 2010**

**Connector Types and Technologies Poised for Growth**

# har-flex® comparison to DIN 41 612 and HM 2mm



Pushing Performance

	DIN 41612	HM 2mm	har-flex®
Contact Spacing	2.54mm	2.00mm	1.27mm
Termination	Through Hole	Through Hole	Surface Mount
Mezzanine	Limited*	No	Yes
Angled to Angled	Yes**	No	Yes
Cable to board	Yes**	No	Yes

\* Height options limited to standard DIN dimensions

\*\* Limited to standard DIN body sizes eg type C/R 96 pins of 2B/2Q 32 pins



DIN 41612

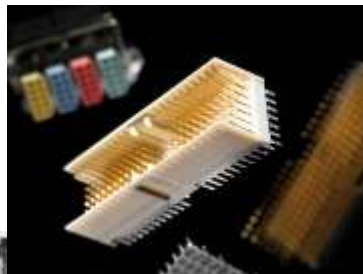
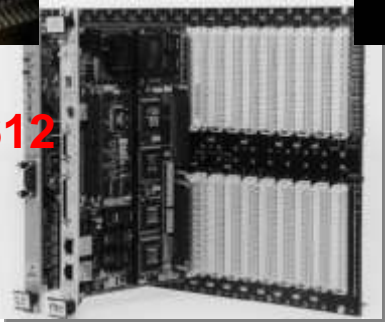

HM 2mm



har-flex®

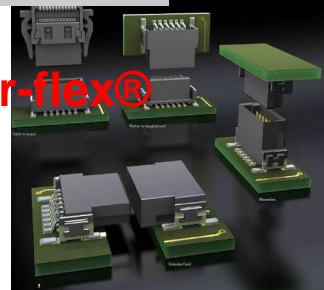

## Medical



## Transportation



## Industrial

Mezzanine card in industrial controller

Extender card in industrial controller

Digital board for barcode reader



## Embedded Computing

Robust Industrial PC

Industrial PC



## Telecom



Inflight broadband



Base station

## Broadcast





# ***har-flex***<sup>®</sup> connector range

- General characteristics
  - Contact Pitch of 1.27 mm
  - Different styles available
  - All even pin counts between 6 and 100 available
  - Different straight stacking heights with wiping length of 1.5mm
  
- Automated processing at the customer
  - SMT termination
  - Suitable for automatic assembly
  - Tape and Reel packaging
  - Vacuum nozzle cover



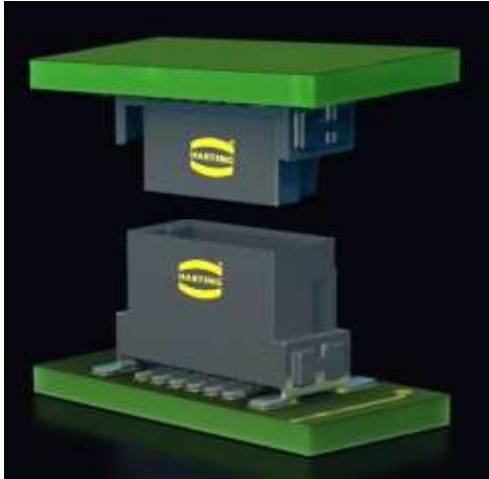

**Mezzanine**  
(2 straight connectors)

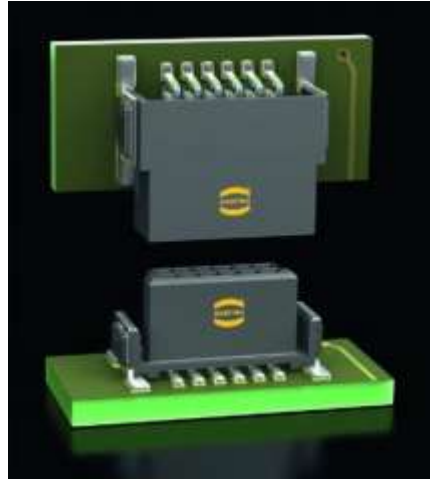

**Mother-to-Daughtercard**  
(straight and angled connectors)



**Cable-to-board**  
(IDC connector with  
either straight or  
angled)

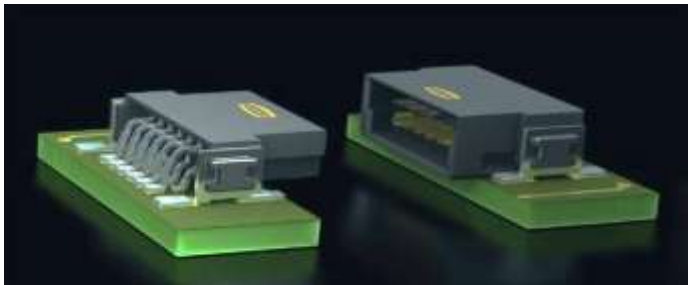

**Extender Card**  
(2 angled connectors)



# har-flex® straight: 4 Stacking heights

Mezzanine Application



Pushing Performance

— Each 2 stacking heights for the straight male and female

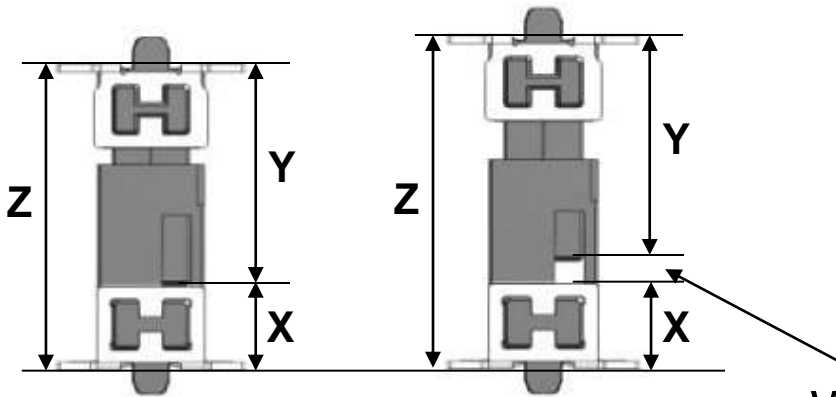

X: stacking height male	Y: stacking height female	Z: mated stacking height including wiping length
1,75 mm	6,25 mm	8,00 - 9,50 mm
3,25 mm	6,25 mm	9,50 - 11,00 mm
1,75 mm	9,05 mm	10,80 - 12,30 mm
3,25 mm	9,05 mm	12,30 - 13,80 mm

Wiping length up to 1.5mm



Male 1.75mm



Male 3.25mm



Female 6.25mm



Female 9.05mm

# har-flex® angled

Extender Card or Mother-Daughtercard Application



Pushing Performance

- no different stacking heights needed
- one male version, one female version
- will be available in all pin counts

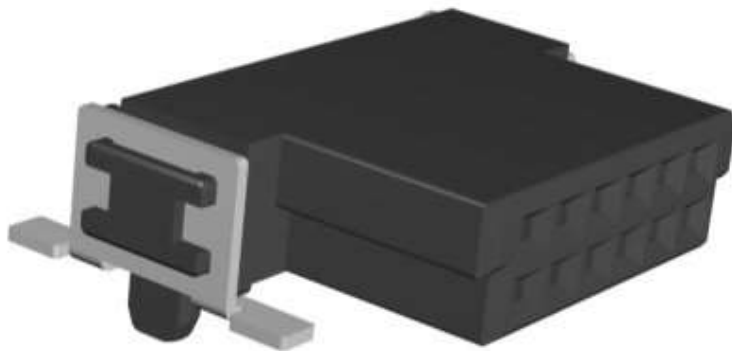

Female



Male

# SMT Solder Termination

Straight and Angled versions



Pushing Performance

- SMT = Surface Mount Technology

**Robust Fixing  
with hold-down**

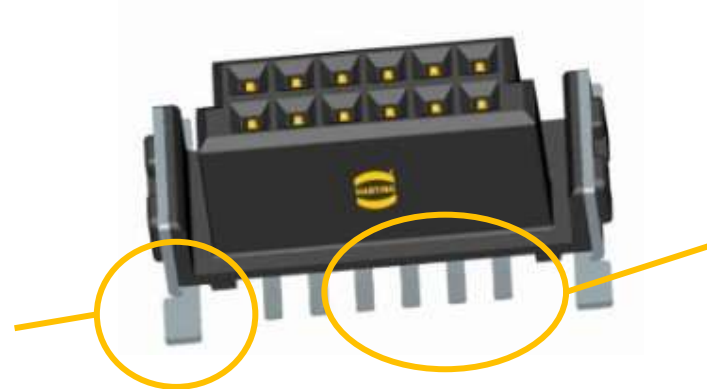

**SMT Solder termination  
contact**

- 100% quality check  
for coplanarity

**Coplanarity =  
all solder contacts in one plane**

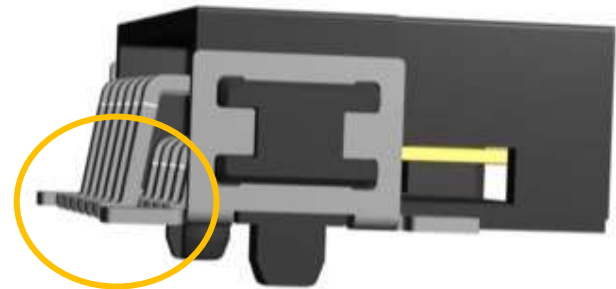

# Packaging

har-flex® straight and angled



Pushing Performance

- Packaging for automatic assembly
  - Tape & reel packaging
  - MOQ straight: 1 reel=280pcs
  - MOQ angled: 1 reel=560pcs
- for MOQ 1pcs, please use sample part number (\*333)



Tape dimensions:	A
poles 06 to 12	24,0
poles 14 to 20	32,0
poles 22 to 40	44,0
poles 42 to 56	56,0
poles 58 to 80	72,0
poles 82 to 100	88,0

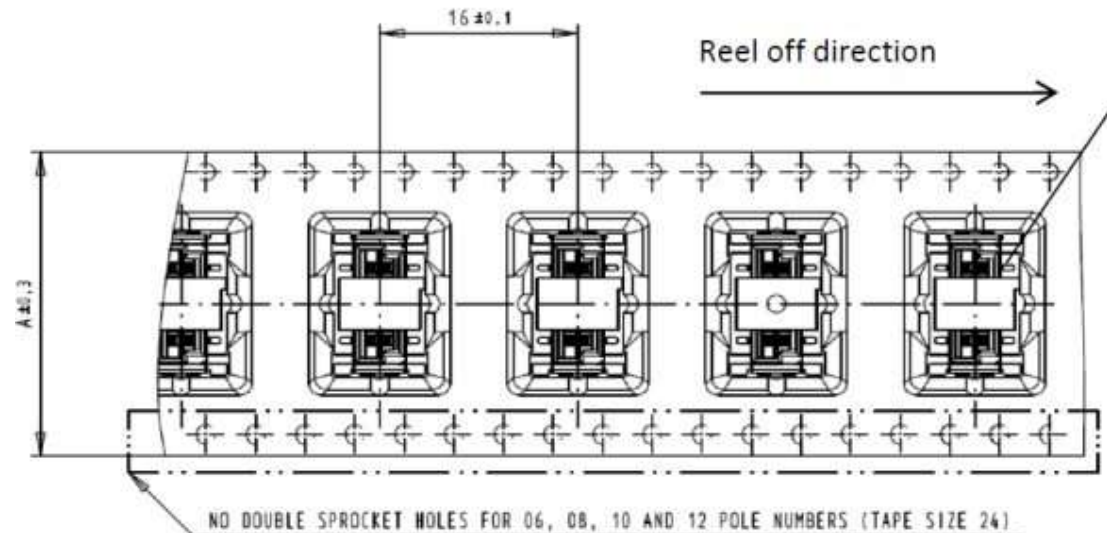

# Vacuum Nozzle Cover



Pushing Performance

- Straight connectors are equipped with a “vacuum cover” for automatic pick and place with a vacuum nozzle

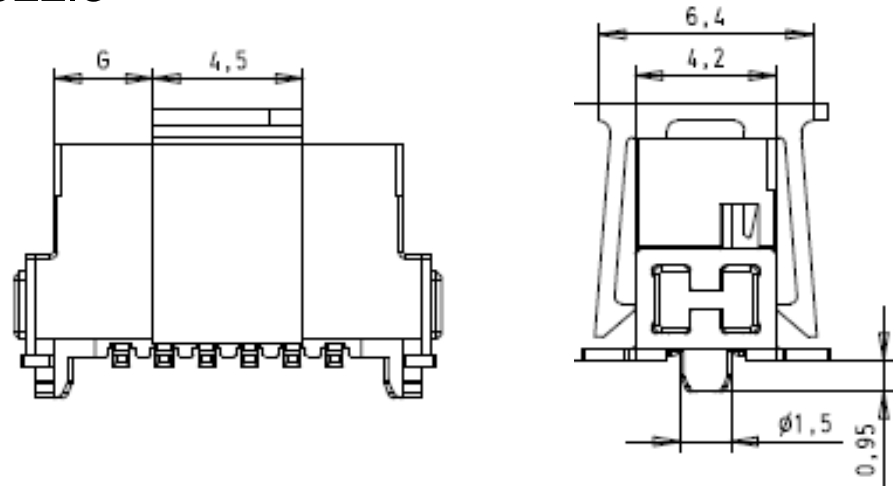
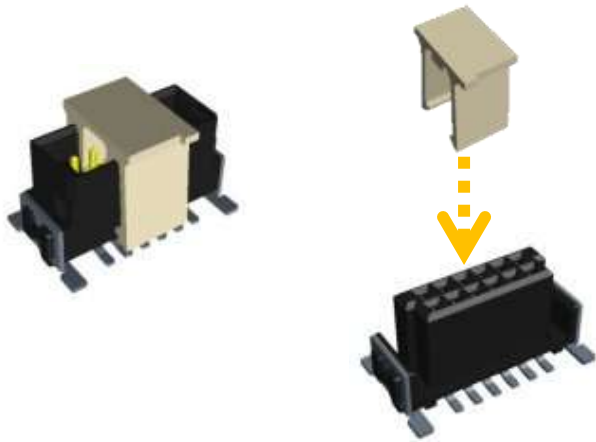

- Angled connectors have a plain area on the top side of the connector where the vacuum nozzle picks up

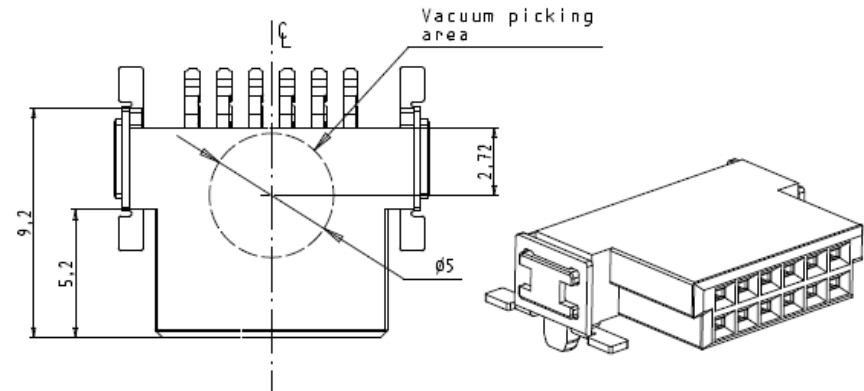

# har-flex<sup>®</sup> cable connector (IDC termination)

Easy assembly of the cable



Pushing Performance

- inserting the cable into the slot of the connector

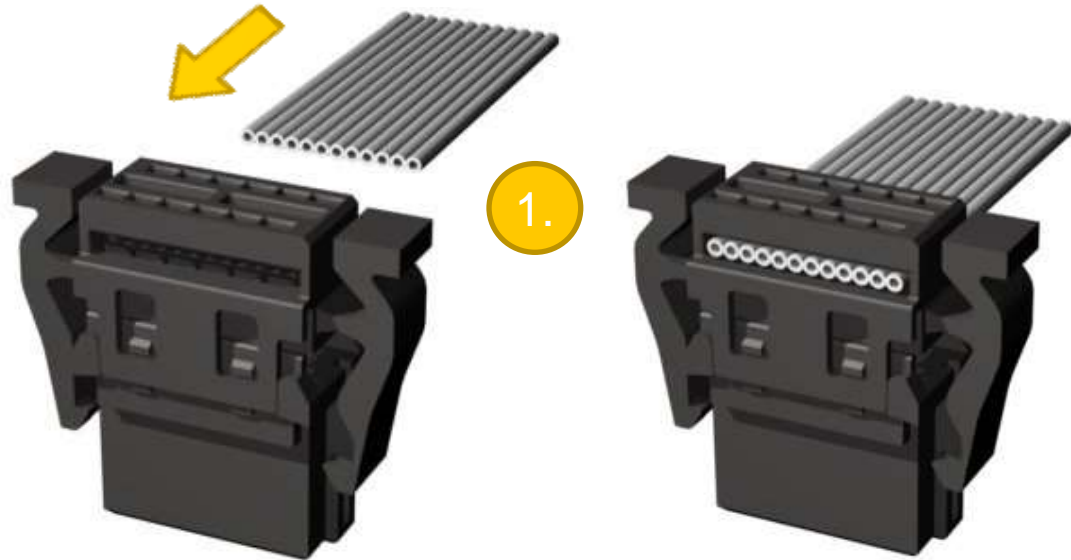

- pushing down the connector cover

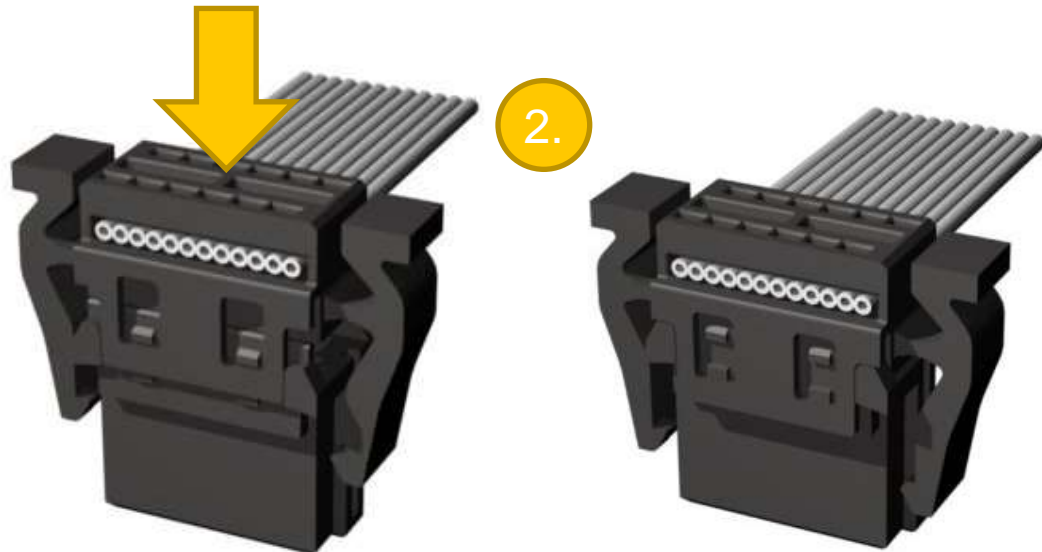

- During mating, the IDC connector locks with its hooks in the male connector
- To unmate the connector, the hooks must be unlocked

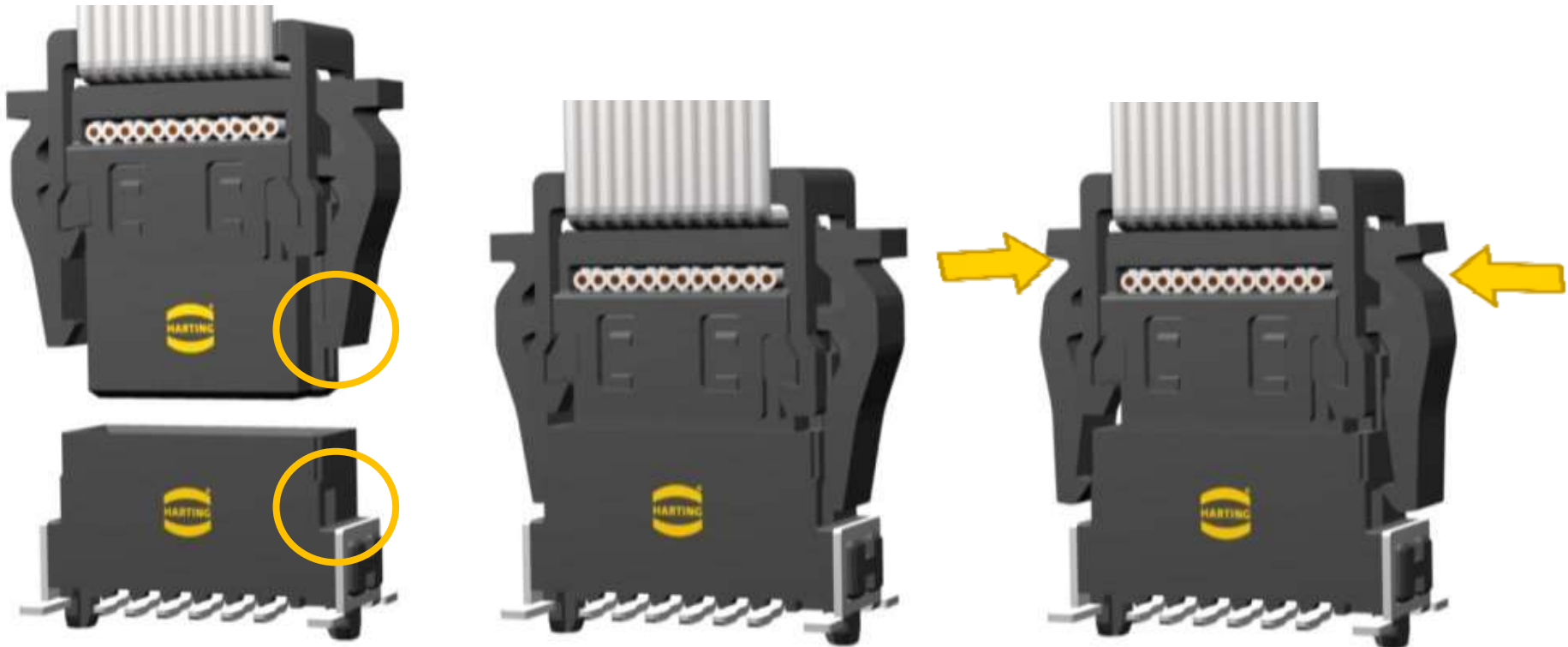

# har-flex<sup>®</sup> cable connector (IDC termination)

Optional strain relief



Pushing Performance

- The strain relief protects the IDC contacts against mechanical stress caused by movements of the cable



assembled connector  
without strain relief



assembled connector  
with strain relief



# har-flex® cable connector (IDC termination)

Strain relief mounting



Pushing Performance

- The strain relief protects the IDC contacts against mechanical stress caused by movements of the cable



# har-flex® cable connector (IDC termination)



Pushing Performance

Optional strain relief

## — Three part numbers for three delivery options

- only the connector  
15 29 xxx x501 000



- both connector and strain relief  
15 29 xxx x502 000



- only the strain relief  
15 29 xxx 0503 000



- Tray
- Quantity depends on number of contacts
- Please sell complete packaging units
- Samples individually bagged



connector tray



tray for strain reliefs



combined packaging:  
connectors and strain reliefs

# har-flex® cable connector (IDC termination)

Cable assemblies



Pushing Performance

- HARTING offers standard cables in the catalog



- Main goal are customer specific cables
  - different lengths possible
  - different pin counts possible
  - with / without strain reliefs

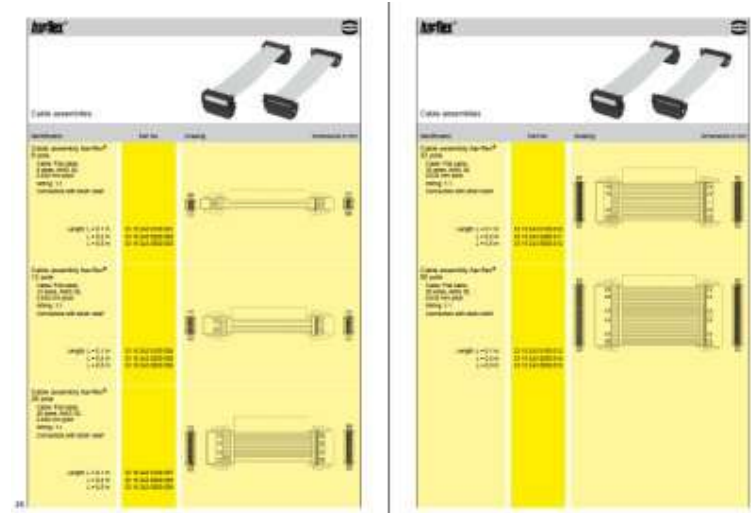

- Customers can also assemble themselves.....



# har-flex® cable connector (IDC termination)

Assembly tools



Pushing Performance

- Hand bench press  
09 99 000 0114
- har-flex® base plate  
15 97 000 0500 000



# IDC hand bench press baseplate

Short instruction



Pushing Performance

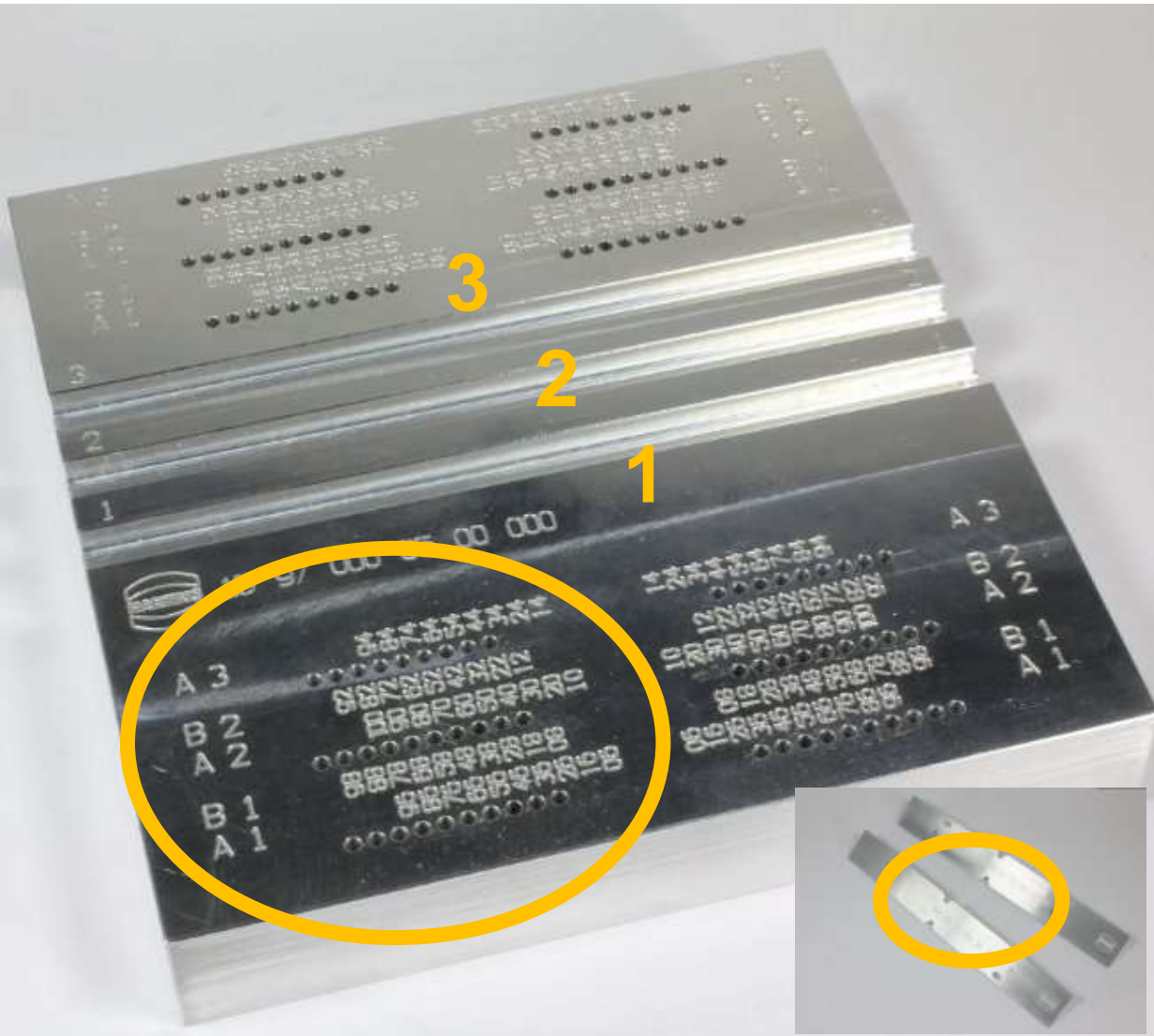

- One baseplate for all sizes
- Different sizes are terminated in different grooves 1, 2, 3
- Cable guides on the baseplate, ensure easy alignment
- Fast, reliable termination
- Don't worry, it is not as complicated as it looks!



# Status Today

# Status *har-flex*® straight connectors



Pushing Performance

- The series production of the *har-flex*® straight connector versions are fully available.
- Production is in our China facility
- Both types, male and female, are available with 2 different stacking heights
- All pin counts are available, though not all are stocked at this time.
- Our FY 2013 price list includes most popular sizes.....
- ....6, 8, 10, 12, 16, 20, 26, 32, 40, 50, 68, 80 contacts.
- For part numbers not in the price list contact product management



# Status *har-flex*® angled connectors



Pushing Performance

- Series delivery of ***har-flex*® angled connectors** with approved parts for design-in purposes will start in the first week of January 2013.
- Production will transfer to China by May 2013
- At this time we will have a wide range of pin counts with the “MOQ 1pcs” part number (ending with \*333) available.
- Production is underway and some pin counts will be available in December.
- Lead time during the ramp up is approx 6 weeks – up to 10 weeks for higher quantities
- Today angled samples in stock but marked as engineering samples. The pin counts in stock are 12, 20, 32, 50, 68 contacts
- Price list will be issued in January



- In January, we will be able to offer the most relevant pin counts of ***har-flex*® IDC connectors** from 6 to 50 contacts. These are 6, 8, 10, 12, 16, 20, 26, 32, 40, 50 Contacts
- NOTE – the maximum pin count for the IDC range will be limited to 50 contacts pending additional tooling development
- Production transfer to China is almost complete
- Initial lead time for non-stocked parts is 10 weeks
- Samples and high volume orders are processed with the part number ending with \*000, there is no special sample part number.
- Today IDC samples in stock but marked as engineering samples. The pin counts in stock are 6, 12, 16, 20, 26 contacts
- Price list will be issued in January



# Marketing material



- In Stock Elgin
- Order part number 98510360201

**har-flex®**

Female connectors, straight

Specification	Number of contacts	Part No.	Dimensions in mm					
			A	B	C	D	E	
Female connector, straight, stacking heights 6.25 / 9.50 mm	6	16.2 306 001	7.34	6.54	3.81	5.56	4.56	
	8	16.2 306 002	7.81	6.23	3.81	6.03	5.03	
	10	16.2 306 003	8.28	5.90	3.81	6.50	5.50	
	12	16.2 312 001	8.75	5.57	3.81	6.97	5.97	
	14	16.2 314 001	9.22	5.24	3.81	7.44	6.44	
	16	16.2 316 001	9.69	4.91	3.81	7.91	6.91	
	18	16.2 318 001	10.16	4.58	3.81	8.38	7.38	
	20	16.2 320 001	10.63	4.25	3.81	8.85	7.85	
	22	16.2 322 001	11.10	3.92	3.81	9.32	8.32	
	24	16.2 324 001	11.57	3.59	3.81	9.79	8.79	
26	16.2 326 001	12.04	3.26	3.81	10.26	9.26		
28	16.2 328 001	12.51	2.93	3.81	10.73	9.73		
30	16.2 330 001	12.98	2.60	3.81	11.20	10.20		
32	16.2 332 001	13.45	2.27	3.81	11.67	10.67		
34	16.2 334 001	13.92	1.94	3.81	12.14	11.14		
36	16.2 336 001	14.39	1.61	3.81	12.61	11.61		
38	16.2 338 001	14.86	1.28	3.81	13.08	12.08		
40	16.2 340 001	15.33	0.95	3.81	13.55	12.55		
42	16.2 342 001	15.80	0.62	3.81	14.02	13.02		
44	16.2 344 001	16.27	0.29	3.81	14.39	13.39		
46	16.2 346 001	16.74	0.00	3.81	14.76	13.76		
48	16.2 348 001	17.21	0.00	3.81	15.13	14.13		
50	16.2 350 001	17.68	0.00	3.81	15.50	14.50		
52	16.2 352 001	18.15	0.00	3.81	15.87	14.87		
54	16.2 354 001	18.62	0.00	3.81	16.24	15.24		
56	16.2 356 001	19.09	0.00	3.81	16.61	15.61		
58	16.2 358 001	19.56	0.00	3.81	16.98	15.98		
60	16.2 360 001	20.03	0.00	3.81	17.35	16.35		
62	16.2 362 001	20.50	0.00	3.81	17.72	16.72		
64	16.2 364 001	20.97	0.00	3.81	18.09	17.09		
66	16.2 366 001	21.44	0.00	3.81	18.46	17.46		
68	16.2 368 001	21.91	0.00	3.81	18.83	17.83		
70	16.2 370 001	22.38	0.00	3.81	19.20	18.20		
72	16.2 372 001	22.85	0.00	3.81	19.57	18.57		
74	16.2 374 001	23.32	0.00	3.81	19.94	18.94		
76	16.2 376 001	23.79	0.00	3.81	20.31	19.31		
78	16.2 378 001	24.26	0.00	3.81	20.68	19.68		
80	16.2 380 001	24.73	0.00	3.81	21.05	20.05		
82	16.2 382 001	25.20	0.00	3.81	21.42	20.42		
84	16.2 384 001	25.67	0.00	3.81	21.79	20.79		
86	16.2 386 001	26.14	0.00	3.81	22.16	21.16		
88	16.2 388 001	26.61	0.00	3.81	22.53	21.53		
90	16.2 390 001	27.08	0.00	3.81	22.90	21.90		
92	16.2 392 001	27.55	0.00	3.81	23.27	22.27		
94	16.2 394 001	28.02	0.00	3.81	23.64	22.64		
96	16.2 396 001	28.49	0.00	3.81	24.01	23.01		
98	16.2 398 001	28.96	0.00	3.81	24.38	23.38		
100	16.2 400 001	29.43	0.00	3.81	24.75	23.75		

0.25 mm ± 1  
0.20 mm ± 2

For performance level 1 for performance level 2  
For 200 pin and 250 pin

# Cardboard box *har-flex*®



Pushing Performance

- cardboard box in *har-flex*® design
- We can use these for a specific promotion campaign with you
- Space for 2 connectors up to 50pin in tape packaging or up to 80pin without tape packaging



## Small, flexible, robust connectors maximize pcb space

**Har-flex series** of space-saving, rugged and flexible pcb connectors are available in straight connector versions, as well as insulation displacement connectors and with right-angled configurations. Based on a 2-row, 1.27-mm grid, products provide all even-numbered models from 6 to 100 pins that allows for optimal utilization of pcb real-estate. For mezzanine applications, product comes in straight models in four different stack heights that allow parallel pcb distances from 8-13.8 mm to be bridged.

HARTING CANADA

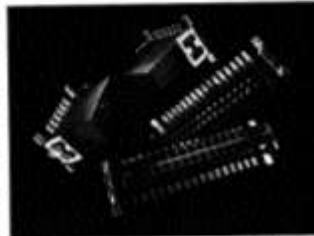

EPT Mar-Apr-2012.

<http://ind.harting.com/MS10.51>

The screenshot shows the HARTING website interface. At the top, there is a navigation bar with the HARTING logo and 'Pushing Performance' tagline. On the right, there are links for 'Login / Register | Help | 99 Deutschland' and a language dropdown set to 'english (english)'. Below this is a search bar with 'All categories' and 'Search term' fields, and a 'Your shopping cart' button. The main content area is titled 'Board-to-Board Connectors' and 'har-flex@ (1.27mm)'. It features a product image of various Har-flex connectors, a detailed description of the series, and a 'Show further information' link. On the right, there is a 'Catalogue har-flex@' section with 'Browse' and 'Download' buttons. Below the main product description, there are two sub-sections: 'Straight connectors' and 'Angled connectors', each with its own product image and description.

## har-flex

People | Power | Partnership

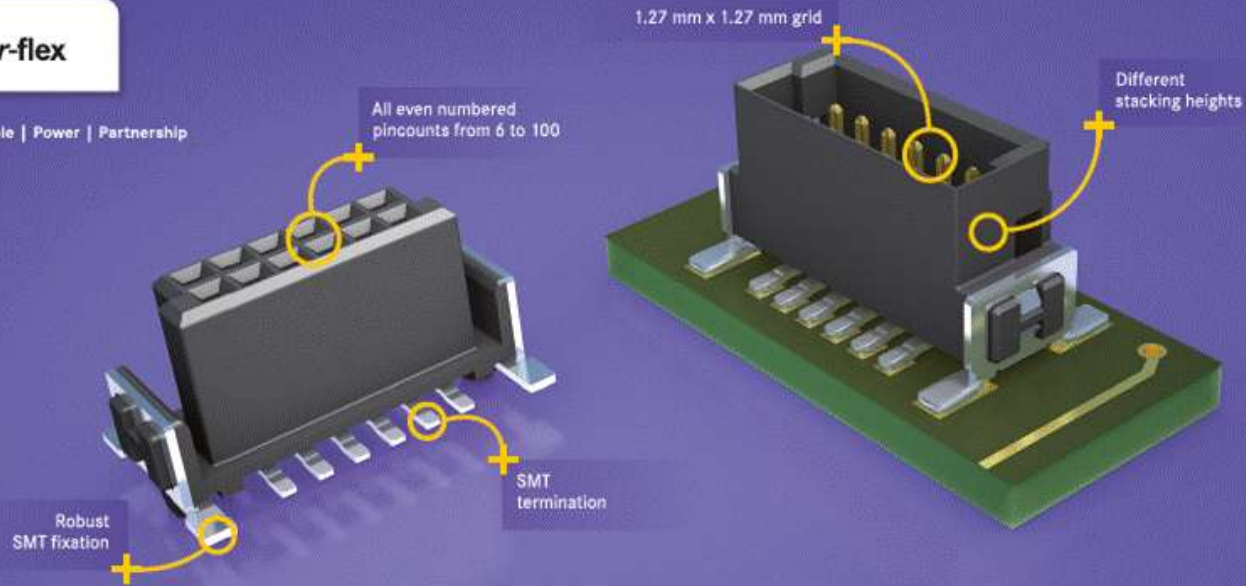

### har-flex. Compact, rugged and highly flexible.

HARTING's *har-flex* offers a space-saving, rugged and flexible solution for the most diverse "board-to-board" applications. Available in 48 different lengths and 4 heights, the *har-flex* product line will continue to expand by offering compatible insulation displacement connectors for "cable-to-board" applications, as well as angled versions.

HARTING: Pushing Performance creates greater flexibility for you.

Please contact: HARTING Electronics GmbH & Co. KG  
Marienwenderstraße 3 | D-32339 Espelkamp | Tel +49 5772 47-97200 | Fax +49 5772 47-7777 | [electronics@HARTING.com](mailto:electronics@HARTING.com)

[www.HARTING.com](http://www.HARTING.com)



Pushing Performance



# Competitor Snapshot



# Direct Competitors

100% compatibility to the *har-flex*<sup>®</sup> connector range



Pushing Performance



**Erni Electronics,  
Germany**

**1.27mm SMC  
connectors**



**Don Connex,  
Taiwan**

**HALF PITCH FEMALE  
HEADER SMT TYPE**

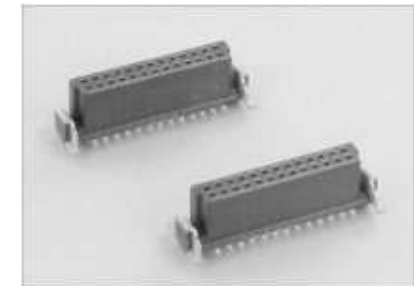

**ITT Cannon**

**MSMC  
connectors**



# Competitor Cross Reference



Pushing Performance

A	B	C	D	E	F	G	H	I
Competitor	Competitor order number	HARTING order number	gender	type	pin count	PL	HARTING Packaging	
ERNI	054594	15150122601000	male	angled	012	PL1	tape&reel, full reels only	
ERNI	054595	15150262601000	male	angled	026	PL1	tape&reel, full reels only	
ERNI	054596	15150502601000	male	angled	050	PL1	tape&reel, full reels only	
ERNI	063179	15120122601000	male	stacking height 3.25mm	012	PL1	tape&reel, full reels only	
ERNI	063209	15120262601000	male	stacking height 3.25mm	026	PL1	tape&reel, full reels only	
ERNI	063210	15120502601000	male	stacking height 3.25mm	050	PL1	tape&reel, full reels only	
ERNI	064316	15210502601000	female	stacking height 6.25mm	050	PL1	tape&reel, full reels only	
ERNI	064317	15210262601000	female	stacking height 6.25mm	026	PL1	tape&reel, full reels only	
ERNI	064318	15210122601000	female	stacking height 6.25mm	012	PL1	tape&reel, full reels only	
ERNI	064319	15110502601000	male	stacking height 1.75mm	050	PL1	tape&reel, full reels only	
ERNI	064320	15110262601000	male	stacking height 1.75mm	026	PL1	tape&reel, full reels only	
ERNI	064321	15110122601000	male	stacking height 1.75mm	012	PL1	tape&reel, full reels only	
ERNI	104557	15250122601000	female	angled	012	PL1	tape&reel, full reels only	
ERNI	104558	15250262601000	female	angled	026	PL1	tape&reel, full reels only	
ERNI	104559	15250502601000	female	angled	050	PL1	tape&reel, full reels only	
ERNI	114803	15220682601000	female	stacking height 9.05mm	068	PL1	tape&reel, full reels only	
ERNI	114804	15220802601000	female	stacking height 9.05mm	080	PL1	tape&reel, full reels only	
ERNI	114805	15150682601000	male	angled	068	PL1	tape&reel, full reels only	
ERNI	114806	15150802601000	male	angled	080	PL1	tape&reel, full reels only	
ERNI	114807	15120682601000	male	stacking height 3.25mm	068	PL1	tape&reel, full reels only	
ERNI	114808	15120802601000	male	stacking height 3.25mm	080	PL1	tape&reel, full reels only	
ERNI	124043	15220122601000	female	stacking height 9.05mm	012	PL1	tape&reel, full reels only	
ERNI	124044	15220262601000	female	stacking height 9.05mm	026	PL1	tape&reel, full reels only	
ERNI	124045	15220502601000	female	stacking height 9.05mm	050	PL1	tape&reel, full reels only	
ERNI	124260	15290122501000	female	IDC without strain relief	012	PL1	tray	
ERNI	124261	15290262501000	female	IDC without strain relief	026	PL1	tray	
ERNI	124262	15290502501000	female	IDC without strain relief	050	PL1	tray	

Cross reference Competitor sort | Cross reference HARTING sort

# Other Competitors

Connectors for similar applications, not compatible with *har-flex*®



Pushing Performance



AMP Modu 1.27mm



Minitek, Ribcage

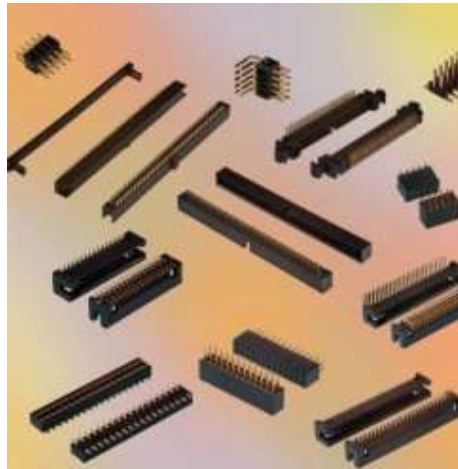

diverse series

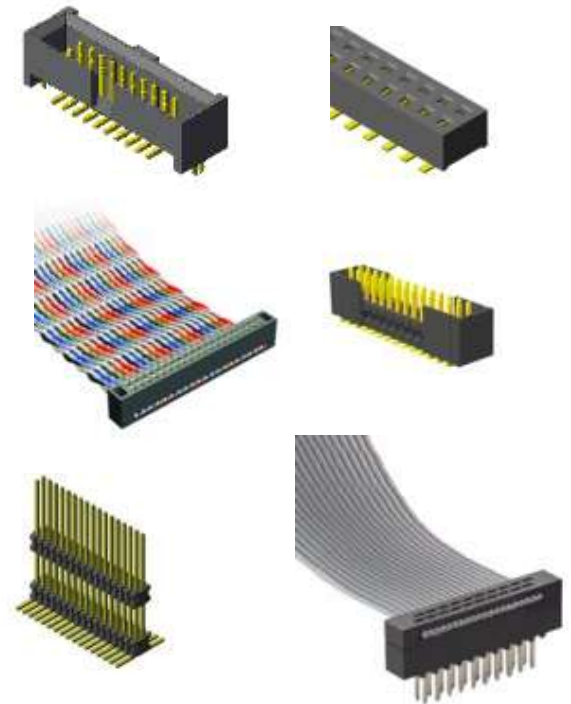

# Other Competitors

Connectors for similar applications, not compatible with *har-flex*®



Pushing Performance



## FX2 series



## NF, NP, NS series

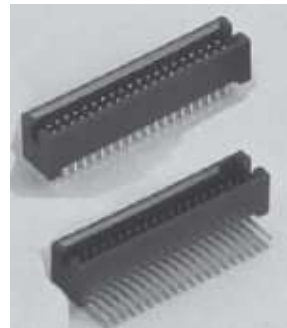

## M50 series





# Logistics information

# Order information for *har-flex*<sup>®</sup>

Part number system



Pushing Performance

**15    x x    x x x    x x 0 1    x x x**

number of contacts  
(always 3 digits)

11 = straight male 1.75mm  
12 = straight male 3.25mm  
15 = angled male  
21 = straight female 6.25mm  
22 = straight female 9.05mm  
25 = angled female  
29 = cable connector

5 = IDC termination  
6 = SMT termination

### Performance Level

2 = PL 1 (500 mating cycles)  
5 = 30µinch PdNi / Au flash  
6 = PL 2 (250 mating cycles)

### Package / Order unit

000 = Tape/Reel (for PCB connectors).  
Tray (for cable connectors)  
333 = Tape „1 piece“ packaging  
*not “333” for cable connectors !*

### PCB connectors

counting number











### IDC connectors

1 = without strain relief  
2 = with strain relief  
3 = only strain relief (PL = 0)

# Order information for *har-flex*®



Pushing Performance

har-flex straight		har-flex angled		har-flex cable IDC
				
p/n *000	p/n *333	p/n *000	p/n *333	p/n *000
Standard p/n	Samples	Standard p/n	Samples	Standard p/n <u>and</u> samples
Tape / Reel 	Tape 	Tape / Reel 	Tape 	Tray 
MOQ 280pcs. Full reels only !	MOQ 1pcs	MOQ 560pcs. Full reels only !	MOQ 1pcs	MOQ 1pcs, full unit preferred
SAP order unit: 1 Reel	SAP order unit: 1 pcs	SAP order unit: 1 Reel	SAP order unit: 1 pcs	SAP order unit: 1 pcs



# Summary



- Miniaturization of PCBs with excellent mechanical stability
- Efficient utilization of the PCB real estate
- Flexible architectures “pizza box” connectivity
- Wide range of pin counts 6 - 100
- Availability even of small batches of customer specific pin counts with a short lead time at competitive pricing
- Assembly of all PCB components in one process (SMT = Surface Mount Termination -> reflow solder process)
- Automatic assembly process -> “pick-and-place” - tape-and-reel packaging
- Compatible with Erni SMC = dual source

- The door is open for all of Distribution partners to sell this exciting new product line.
- Tell us where you see opportunities and allow us to support you addressing those opportunities.
- Consider specific campaigns to your target customers and markets

*“Flexible connectivity solutions for board to board and board to cable applications. Robust SMT design for ease of processing and full compatibility with surface mount boards. Optimized use of available real estate through availability of all even numbered contact counts from 6 to 100 contacts”*

thank you  
for your attention



单击下面可查看定价，库存，交付和生命周期等信息

[>>HARTING](#)