

MaxiBridge

2.54 mm Connectors

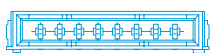

Full-scale MaxiBridge 8 Pins

Ed. 11 | 07.2016

Catalog E 074593

MaxiBridge - 2.54 mm Connectors

CABLE CONNECTOR SYSTEM —

GENERAL

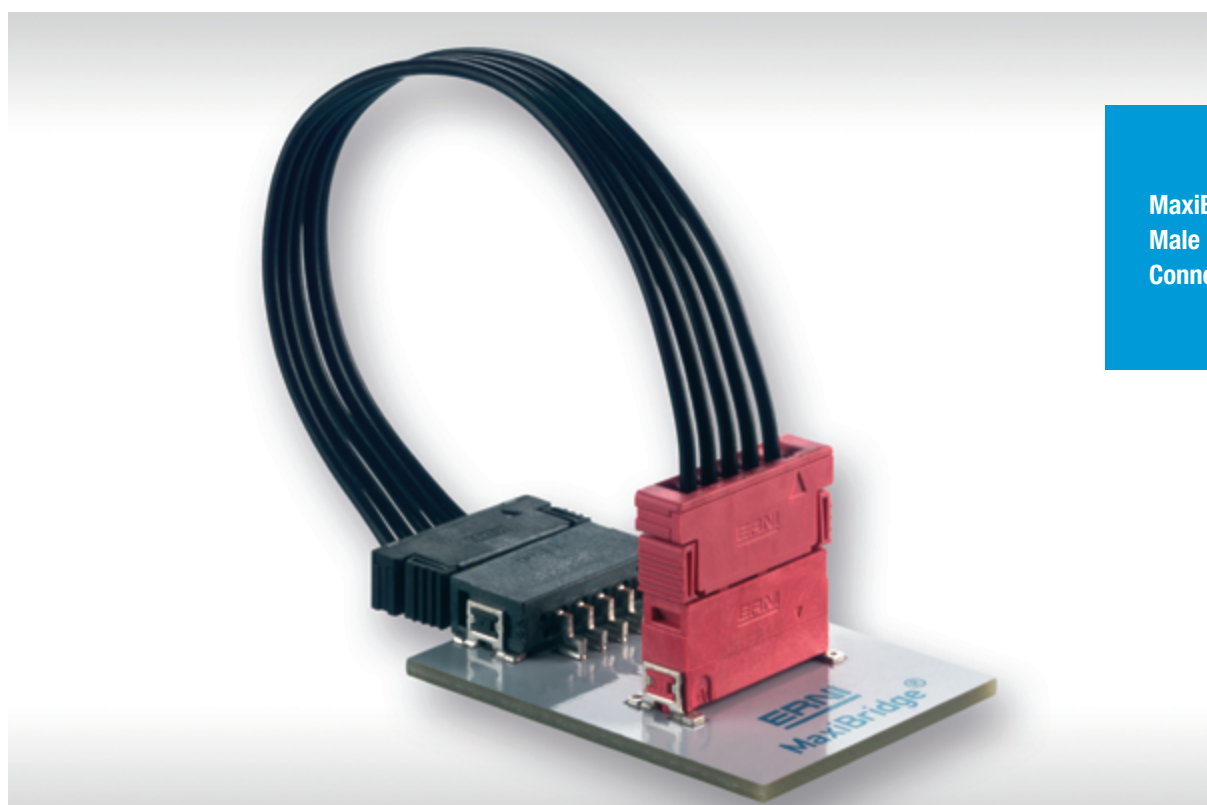

**MaxiBridge
Male and Female
Connector**

The 2.54 mm single and dual row cable connector system is ideally suitable for high reliable and space saving connections between PCBs and decentral units, e.g. lamps or info panels, front plate elements like buttons, switches or LEDs, motors, fans etc. The cable system can be used in different applications, for example: automotive, industrial, medical or even lighting technology. Thanks to the availability of vertical and right angle male connectors and female connectors with 180° cable outlet the system can be used in a versatile manner. Emphasis is put on flexibility of the usable cable sizes. Thus the required current rating can be adjusted over a wide range.

The vertical and right angle male connectors provide SMT-terminals and the female connector has contact cavities according to the crimp contacts. The plastic material used is suitable for lead-free reflow soldering. Tape and reel packaging and pick and place pad for fully automatic assembly is a standard.

The crimp contacts are secured twice and reach highest retention forces. For each pin number, there are four mechanical and different colored coding versions with high blocking forces against mismatching available. Cable and male connector have a locking system on both sides, which prevents the contact from loosening due to vibration. The robust interlocking can be manually released without tools.

MaxiBridge - 2.54 mm Connectors

CONCEPT

FEATURES

Pitch	2.54 mm
No. of Pins	2, 3, 4, 5, 6, 8, 2x5, 2x10
Current rating per contact	up to 12 A (depends on cable)
Termination technology	Male connector SMT, female connector crimp
Cable	Single stranded wires AWG 18, AWG 20, AWG 22, AWG 24, AWG 26
Connectors	Single row male connectors, vertical and right angle Dual row male connectors, vertical and right angle Cable assemblies: - Female connectors crimp, vertical
Coding	black, blue, green, red
Automotive standard	particular wire cross sections have been tested according to the requirements of LV214 for automotive connectors

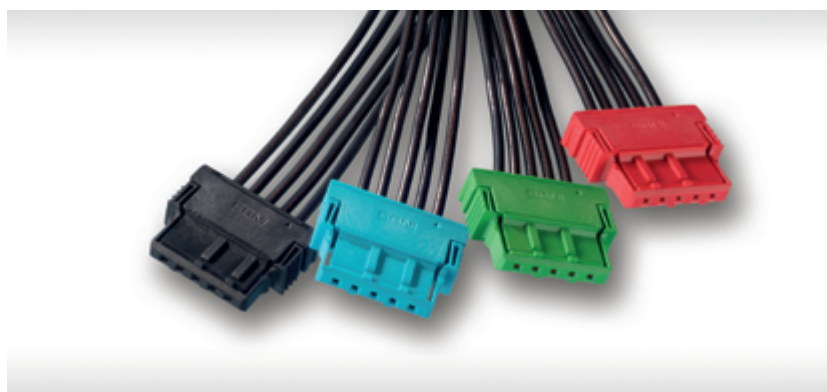

Robust interlocking with four different colored codings per pin number

MaxiBridge - 2.54 mm Connectors

CAPABILITIES —



SINGLE ROW VARIANTS

Right angle male -
Female with 180° cable outlet

Vertical male -
Female with 180° cable outlet

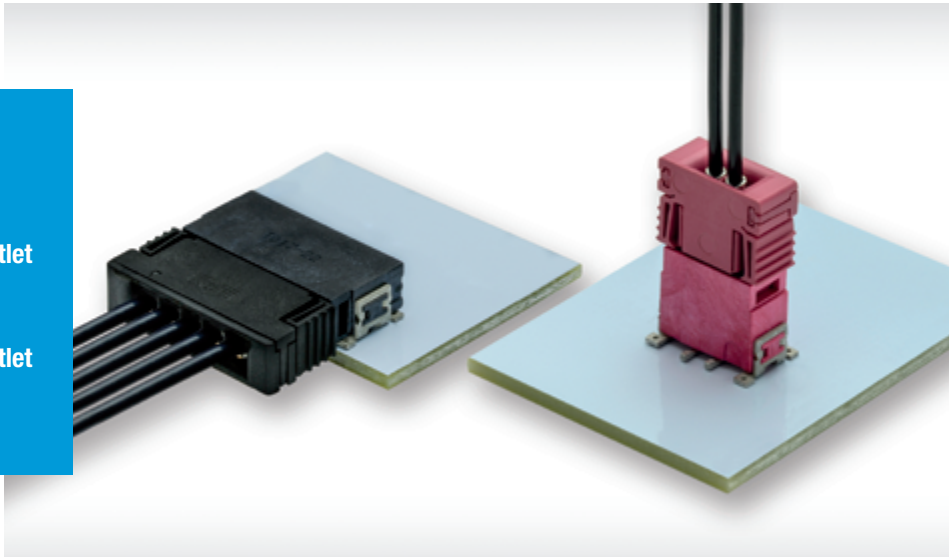

DUAL ROW VARIANTS

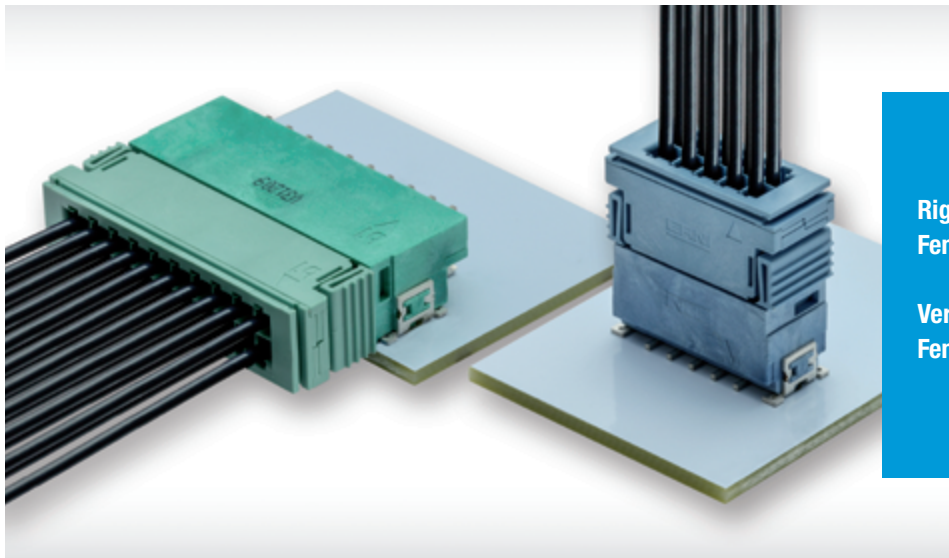

Right angle male -
Female with 180° cable outlet

Vertical male -
Female with 180° cable outlet

MaxiBridge - 2.54 mm Connectors

FEATURES —



HOUSING GUIDE

The rugged **insulation body** of the male connector ensures an optimal cable connector guide.

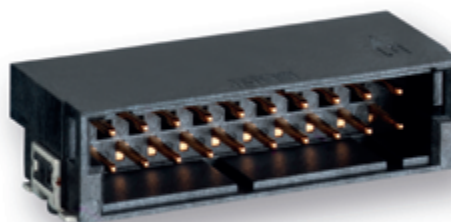

LOCATING PEGS

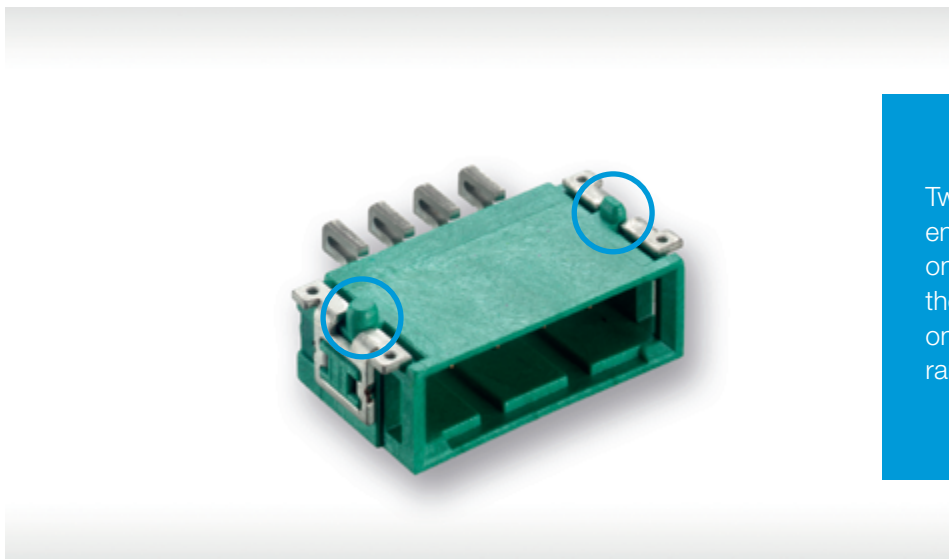

Two **pegs** (round and oval) ensures exact positioning on the PCB. In addition, they enable a compensation of the PCB hole tolerances.

MaxiBridge - 2.54 mm Connectors

FEATURES

EASY ASSEMBLY

Pick-and-place cover for automatic assembly of the vertical male connectors with a vacuum pipette.

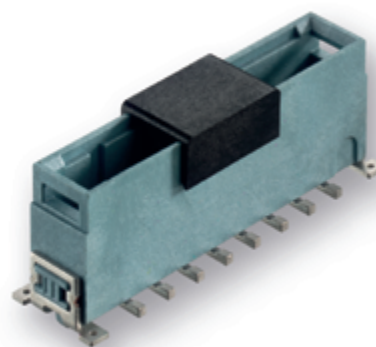

ROBUST SOLDER CLIPS



Reliable retention force on the PCB due to ruggedized **solder clips**. In addition, they serve as an integrated strain relief.

MaxiBridge - 2.54 mm Connectors

FEATURES —

LOCKING FOR HOUSING

The robust **locking system** with latches on both sides can be manually released without tools and withstands high vibrations. During the locking process, there is an audible latching.

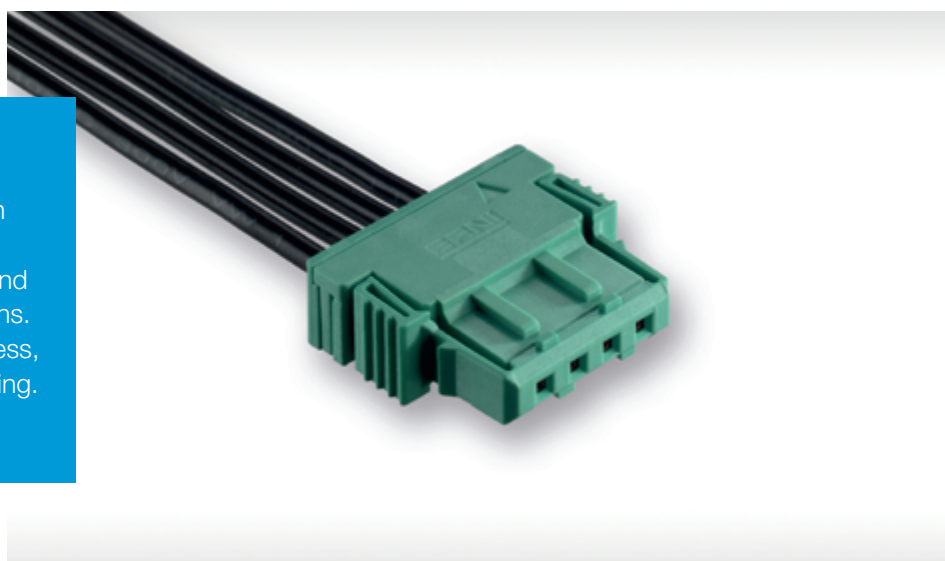

CONTACT LOCKING

Primary and **secondary locking** of the crimp contact inside the connector housing.

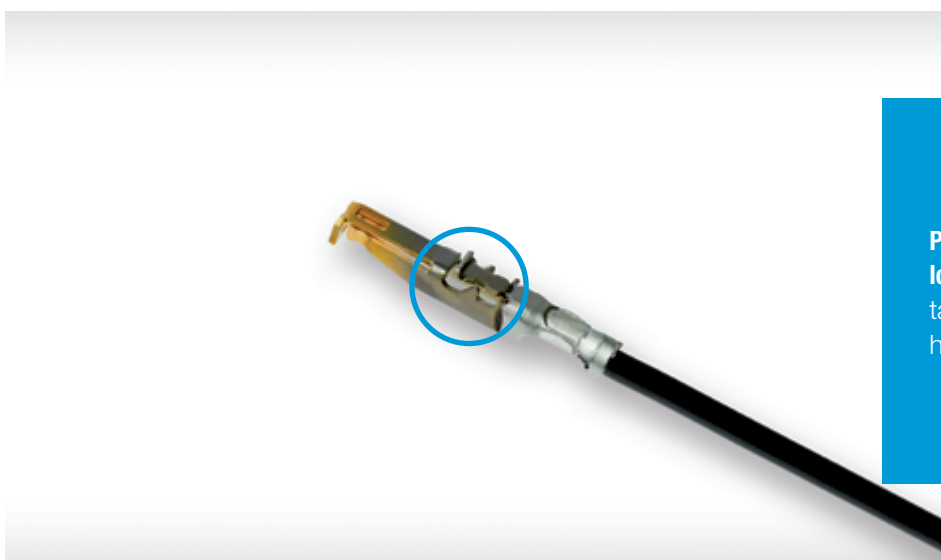

MaxiBridge - 2.54 mm Connectors

FEATURES —



CODING

Four **different colored** codings per pin number. With high blocking forces against mismatching.

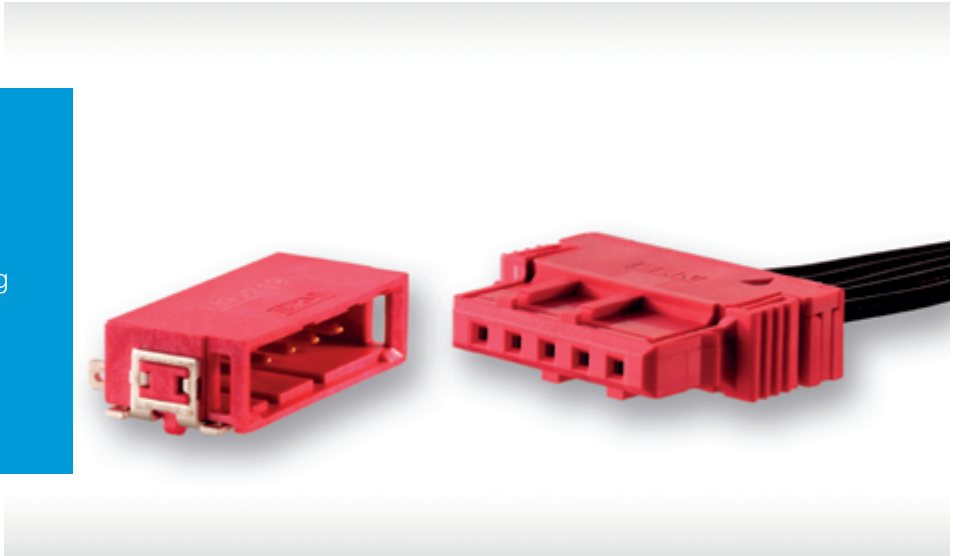

SSL-LIGHTING TECHNOLOGY

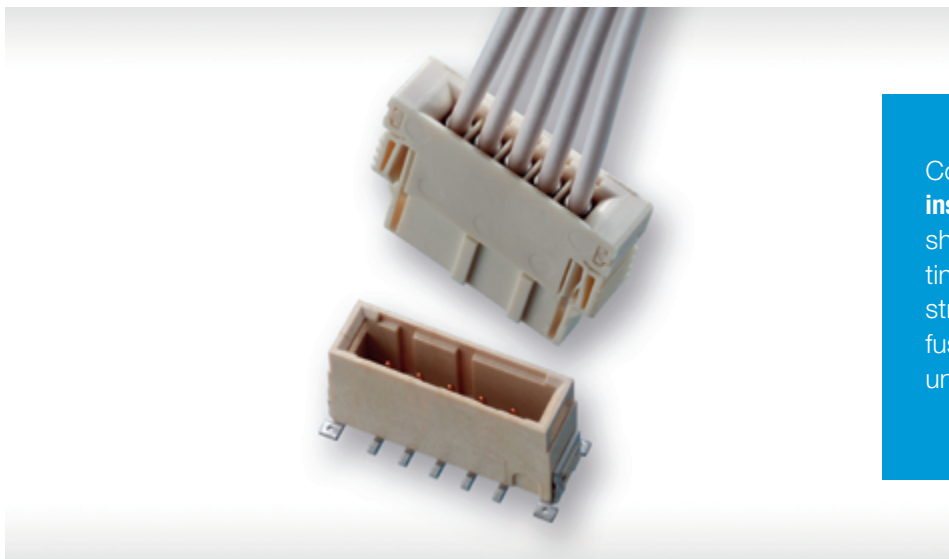

Connectors with **colorless insulation bodies** prevent shadow formation in lighting applications, e.g. LED strips with transparent diffusion disks. Thus ensuring uniform light distribution.

MaxiBridge - 2.54 mm Connectors

PROCESSING —

TAPE AND REEL PACKAGING

Transport safe packaging
and fully automatic assembly.



FULLY AUTOMATIC ASSEMBLY AND REFLOW SOLDERING

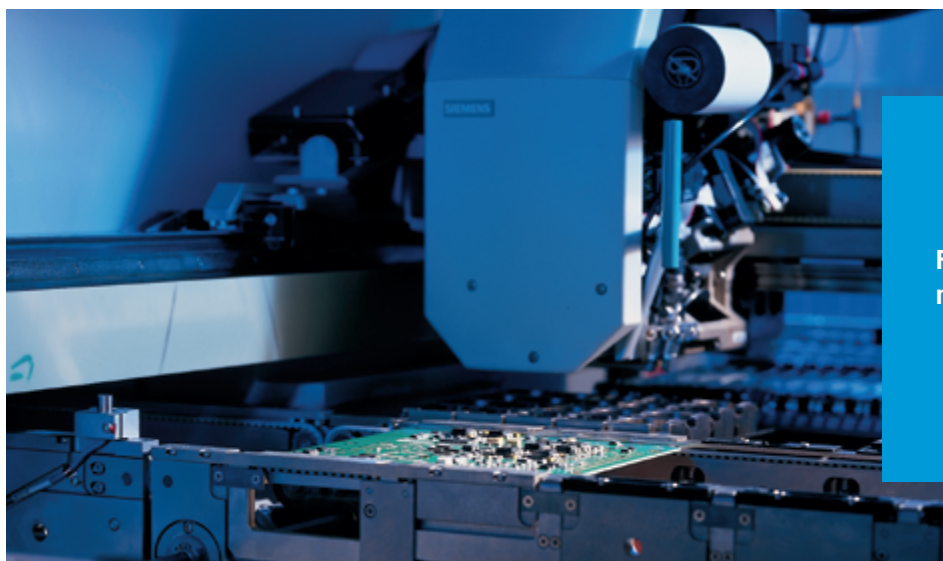

For efficient processing on
modern assembly lines.

MaxiBridge - 2.54 mm Connectors

CHARACTERISTICS

TECHNICAL DATA

Description	Standard	Male Connectors Single and Dual Row	Female Connectors Single and Dual Row
Climate category	DIN EN 60068-1 test b	55 / 150 / 56	
Temperature range		-55 / 150 °C	
Current rating per contact	IEC 60512 test 5b	up to 12 A (depends on cable)	
Air- and creepage distance		contact - contact min. 1.2 mm	
Operating voltage	IEC 60664	<p>The permissible operating voltages depend on the customer application and on the applicable or specified safety requirements. Insulation coordination according to IEC 60664-1 has to be regarded for the complete electrical device. Therefore, the maximum creepage and clearance distances of the mated connectors are specified for consideration as a part of the whole current path. In practice, reductions in creepage or clearance distances may occur due to the conductive pattern of the printed board or the wiring used, and have to be taken into account separately. As a result the creepage and clearance distances for the application may be reduced compared to those of the connector.</p>	
Dielectric strength	IEC 60512 test 4a	contact – contact 1000 V _{rms}	
Contact resistance	IEC 60512 test 2a	≤ 20 mΩ	
Insulation resistance	IEC 60512 test 3a	≥ 10 ³ MΩ	
Broadband noise	DIN EN 60068-2-64	10 – 1000 Hz 27.8 m/s ²	
Contact disturbance (while broadband noise)	DIN EN 60068-2-64	< 1 μs	
Shock half sine	IEC 60068-2-27	30 g 6 ms	
Contact disturbance (while shock test)	IEC 60512 test 2e	< 1 μs	

MaxiBridge - 2.54 mm Connectors

CHARACTERISTICS —

Description	Standard	Male Connectors Single and Dual Row	Female Connectors Single and Dual Row
Mechanical operation	IEC 60512 test 9a	500 mating cycles	
Insertion and withdrawal force	IEC 60512 test 13b	≤ 1 N per contact	
Gauge retention force	IEC 60512 test 16e	> 0,15 N	
Processing Conditions			
Hand soldering temperature max.	IEC 60068-2-20	3.5 s at 350 °C	
Reflow soldering temperature max.	JEDEC J-STD-020	30 s at 260 °C	
Coplanarity		< 0.1 mm	
Housing Material			
Insulation body		LCP	PA46
CTI value	IEC 112	175	225
UL flame rating		UL 94 V-0	UL 94 V-0
UL file plastic material		E83005	E47960
Contact Material			
Base material		Cu alloy	
Mating area		gold plating	
Termination area		Sn	
Environment Compatibility			
Recycling		no flame-retardent additives, no toxic additives allow easy recycling	
Product Approval			
UL		E84703	

MaxiBridge - 2.54 mm Connectors

RIGHT ANGLE MALE, SINGLE ROW

PRODUCT SPECIFICATION



- SMT termination
- single row connectors
- current rating up to 12 A per contact
- fully automated board assembly
- four different colored codings

DIMENSIONAL DRAWINGS

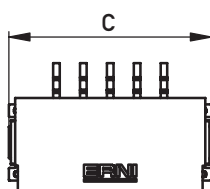
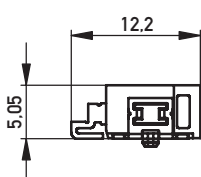
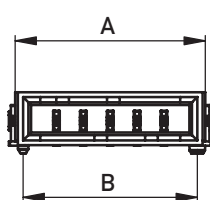

8	25.58	24.08	26.78
6	20.50	19.00	21.70
5	17.96	16.46	19.16
4	15.42	13.92	16.62
3	12.88	11.38	14.08
2	10.34	8.84	11.54
No. of Contacts	A	B	C

Recommended Layout

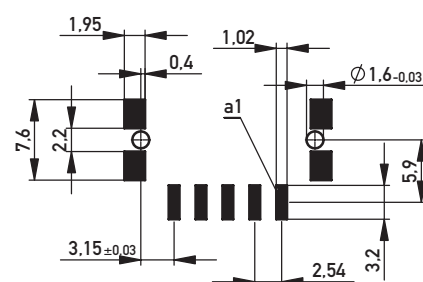

MaxiBridge - 2.54 mm Connectors

RIGHT ANGLE MALE, SINGLE ROW

ORDERING INFORMATION

No. of Pins	Coding	Termination	Packaging	Part Number
2	black	SMT	Tape and reel	234832
2	white	SMT	Tape and reel	454189
2	blue	SMT	Tape and reel	234833
2	green	SMT	Tape and reel	234834
2	red	SMT	Tape and reel	234835
3	black	SMT	Tape and reel	284052
3	white	SMT	Tape and reel	454191
3	blue	SMT	Tape and reel	284053
3	green	SMT	Tape and reel	284054
3	red	SMT	Tape and reel	284055
4	black	SMT	Tape and reel	384471
4	white	SMT	Tape and reel	454193
4	blue	SMT	Tape and reel	384472
4	green	SMT	Tape and reel	384473
4	red	SMT	Tape and reel	384474
5	black	SMT	Tape and reel	254823
5	white	SMT	Tape and reel	444807
5	blue	SMT	Tape and reel	254824

MaxiBridge - 2.54 mm Connectors

RIGHT ANGLE MALE, SINGLE ROW

No. of Pins	Coding	Termination	Packaging	Part Number
5	green	SMT	Tape and reel	254825
5	red	SMT	Tape and reel	254826
6	black	SMT	Tape and reel	254699
6	white	SMT	Tape and reel	454195
6	blue	SMT	Tape and reel	254700
6	green	SMT	Tape and reel	254701
6	red	SMT	Tape and reel	254702
8	black	SMT	Tape and reel	284121
8	white	SMT	Tape and reel	454197
8	blue	SMT	Tape and reel	284122
8	green	SMT	Tape and reel	284123
8	red	SMT	Tape and reel	284124

MaxiBridge - 2.54 mm Connectors

RIGHT ANGLE MALE, DUAL ROW

PRODUCT SPECIFICATION



- SMT termination
- dual row connectors
- current rating up to 12 A per contact
- fully automated board assembly
- four different colored codings

DIMENSIONAL DRAWINGS

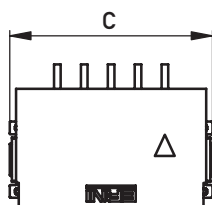
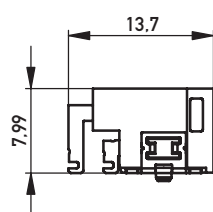
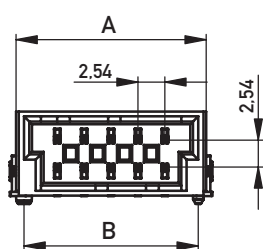

20	30.66	29.16	31.86
10	17.96	16.46	19.16
No. of Contacts	A	B	C

Recommended Layout

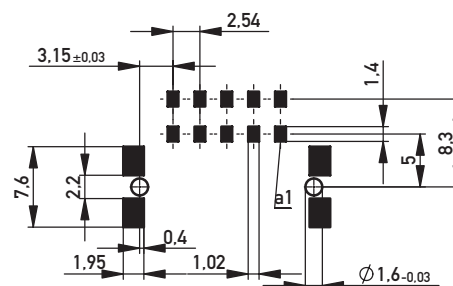

MaxiBridge - 2.54 mm Connectors

RIGHT ANGLE MALE, DUAL ROW

ORDERING INFORMATION

No. of Pins	Coding	Packaging	Part Number
10	black	Tape and reel	474016
10	blue	Tape and reel	474017
10	green	Tape and reel	474018
10	red	Tape and reel	474019
20	black	Tape and reel	374317
20	blue	Tape and reel	374318
20	green	Tape and reel	374319
20	red	Tape and reel	374320

MaxiBridge - 2.54 mm Connectors

VERTICAL MALE, SINGLE ROW

PRODUCT SPECIFICATION



- SMT termination
- single row connectors
- current rating up to 12 A per contact
- fully automated board assembly
- four different colored codings

DIMENSIONAL DRAWINGS

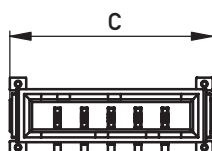
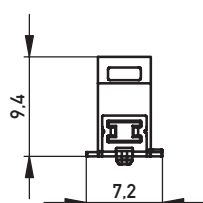
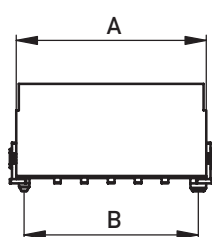

8	25.58	24.08	26.78
6	20.50	19.00	21.70
5	17.96	16.46	19.16
4	15.42	13.92	16.62
3	12.88	11.38	14.08
2	10.34	8.84	11.54
No. of Contacts	A	B	C

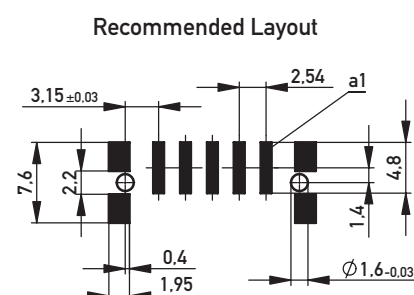

MaxiBridge - 2.54 mm Connectors

VERTICAL MALE, SINGLE ROW

ORDERING INFORMATION

No. of Pins	Coding	Termination	Packaging	Part Number
2	black	SMT	Tape and reel	294645
2	white	SMT	Tape and reel	454199
2	blue	SMT	Tape and reel	294646
2	green	SMT	Tape and reel	294647
2	red	SMT	Tape and reel	294648
3	black	SMT	Tape and reel	284656
3	white	SMT	Tape and reel	454201
3	blue	SMT	Tape and reel	284657
3	green	SMT	Tape and reel	284658
3	red	SMT	Tape and reel	284659
4	black	SMT	Tape and reel	384462
4	white	SMT	Tape and reel	454203
4	blue	SMT	Tape and reel	384463
4	green	SMT	Tape and reel	384464
4	red	SMT	Tape and reel	384465
5	black	SMT	Tape and reel	254831
5	white	SMT	Tape and reel	454205
5	blue	SMT	Tape and reel	254832

MaxiBridge - 2.54 mm Connectors

VERTICAL MALE, SINGLE ROW —

No. of Pins	Coding	Termination	Packaging	Part Number
5	green	SMT	Tape and reel	254833
5	red	SMT	Tape and reel	254834
6	black	SMT	Tape and reel	254707
6	white	SMT	Tape and reel	454207
6	blue	SMT	Tape and reel	254708
6	green	SMT	Tape and reel	254709
6	red	SMT	Tape and reel	254710
8	black	SMT	Tape and reel	294649
8	white	SMT	Tape and reel	454209
8	blue	SMT	Tape and reel	294650
8	green	SMT	Tape and reel	294651
8	red	SMT	Tape and reel	294652

MaxiBridge - 2.54 mm Connectors

VERTICAL MALE, DUAL ROW

PRODUCT SPECIFICATION



- SMT termination
- dual row connectors
- current rating up to 12 A per contact
- fully automated board assembly
- four different colored codings

DIMENSIONAL DRAWINGS

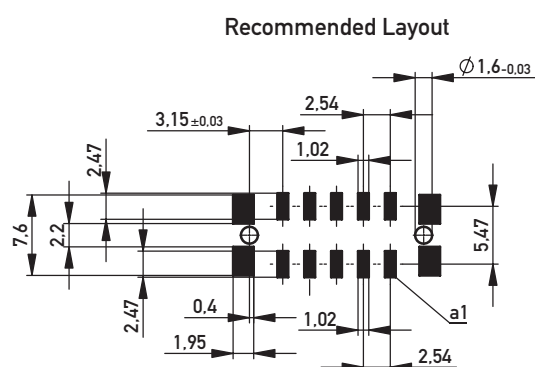
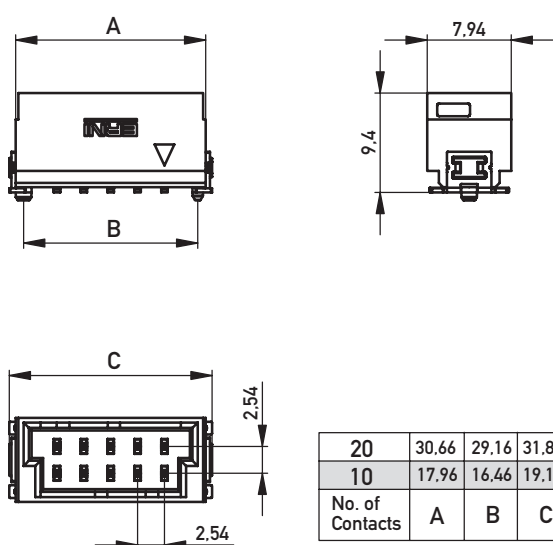

MaxiBridge - 2.54 mm Connectors

VERTICAL MALE, DUAL ROW

ORDERING INFORMATION

No. of Pins	Coding	Packaging	Part Number
10	black	Tape and reel	474006
10	blue	Tape and reel	474007
10	green	Tape and reel	474008
10	red	Tape and reel	474009
20	black	Tape and reel	464686
20	blue	Tape and reel	464687
20	green	Tape and reel	464688
20	red	Tape and reel	464689

MaxiBridge - 2.54 mm Connectors

CABLE ASSEMBLIES, SINGLE ROW

PRODUCT SPECIFICATION



- cable assemblies with crimp female connectors
- single row connectors
- different cable types
- connectors with four different colored codings
- wire cross sections AWG 18, 20, 22, 24 and 26

DIMENSIONAL DRAWINGS

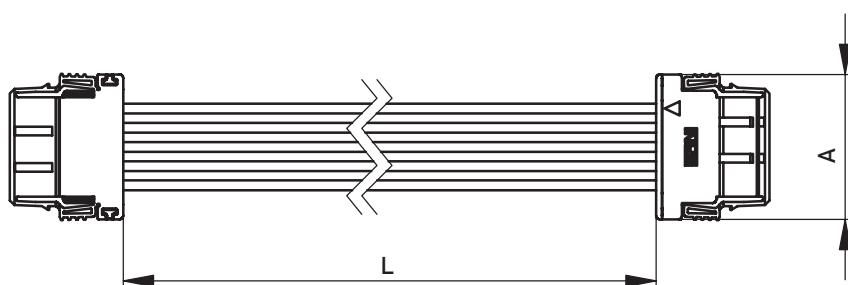

8	26.78
6	21.70
5	19.16
4	16.62
3	14.08
2	11.54
No. of Contacts	A

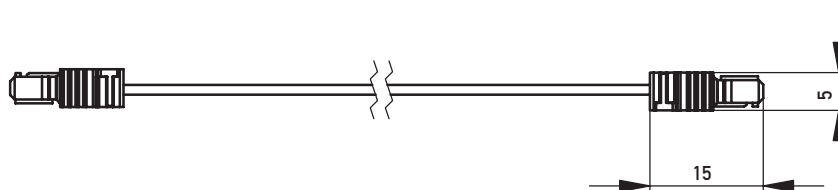

MaxiBridge - 2.54 mm Connectors

CABLE ASSEMBLIES, SINGLE ROW

ORDERING INFORMATION

No. of Pins	Connector Left	Connector Right	Cable Length	Cable Type	Wire Cross Section	Coding	Part Number
2	Female straight	–	50	High Temp.	AWG 24	white	176036
3	Female straight	Female straight	200	High Temp.	AWG 18	blue	176037
3	Female straight	Female straight	100	PVC	AWG 24	black	176038
4	Female straight	–	100	PVC	AWG 20	green	176039
5	Female straight	Female straight	100	High Temp.	AWG 26	blue	176040
5	Female straight	Female straight	200	PVC	AWG 22	red	176041
6	Female straight	–	100	High Temp.	AWG 18	green	176042
8	Female straight	–	200	PVC	AWG 20	white	176043

More cable assemblies available on request.

MaxiBridge - 2.54 mm Connectors

CABLE ASSEMBLIES, DUAL ROW

PRODUCT SPECIFICATION

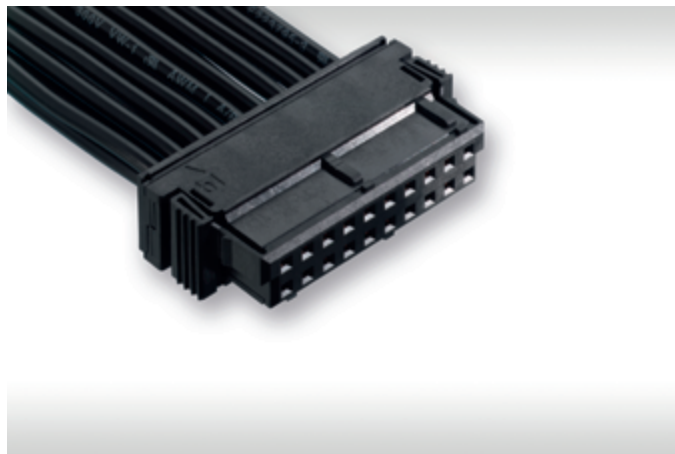

- cable assemblies with crimp female connectors
- single row connectors
- different cable types
- connectors with four different colored codings
- wire cross sections AWG 18, 20, 22, 24 and 26

DIMENSIONAL DRAWINGS

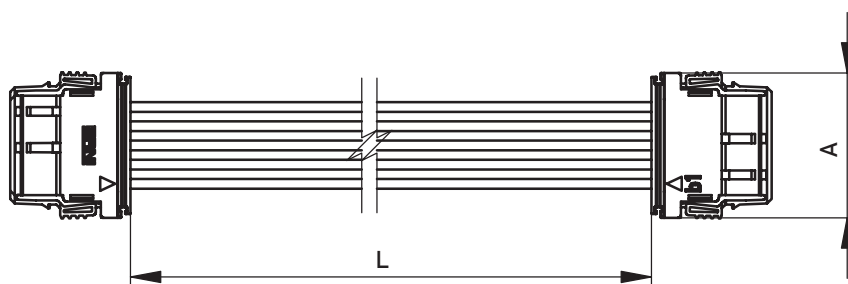

20	31.86
10	19.16
No. of Contacts	A

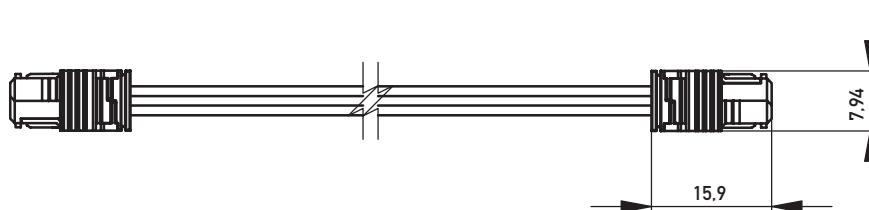



MaxiBridge - 2.54 mm Connectors

CABLE ASSEMBLIES, DUAL ROW

ORDERING INFORMATION

No. of Pins	Connector Left	Connector Right	Cable Length	Cable Type	Wire Cross Section	Coding	Part Number
10	Female straight	Female straight	100	PVC	AWG 26	red	176044
20	Female straight	Female straight	200	High Temp.	AWG 22	black	176045

More cable assemblies available on request.

MaxiBridge - 2.54 mm Connectors

PART NUMBER INDEX —

Part Number	Page
176036	23
176037	23
176038	23
176039	23
176040	23
176041	23
176042	23
176043	23
176044	25
176045	25
234832	13
234833	13
234834	13
234835	13
254699	14
254700	14
254701	14
254702	14
254707	19
254708	19
254709	19
254710	19
254823	13
254824	13
254825	14
254826	14

Part Number	Page
254831	18
254832	18
254833	19
254834	19
284052	13
284053	13
284054	13
284055	13
284121	14
284122	14
284123	14
284124	14
284656	18
284657	18
284658	18
284659	18
294645	18
294646	18
294647	18
294648	18
294649	19
294650	19
294651	19
294652	19
374317	16
374318	16



MaxiBridge - 2.54 mm Connectors

PART NUMBER INDEX —

Part Number	Page
374319	16
374320	16
384462	18
384463	18
384464	18
384465	18
384471	13
384472	13
384473	13
384474	13
444807	13
454189	13
454191	13
454193	13
454195	14
454197	14
454199	18

Part Number	Page
454201	18
454203	18
454205	18
454207	19
454209	19
464686	21
464687	21
464688	21
464689	21
474006	21
474007	21
474008	21
474009	21
474016	16
474017	16
474018	16
474019	16

ERNI Electronics GmbH & Co. KG

Seestrasse 9
73099 Adelberg
Germany
Tel +49 7166 50-0
Fax +49 7166 50-282
info@erni.com
www.erni.com

Europe South America Africa

ERNI Electronics, Inc.

2201 Westwood Ave
Richmond, VA 23230/USA
Tel +1 804 228-4100
Fax +1 804 228-4099
info@erni.us

North America Canada Mexico

ERNI Asia Holding Pte Ltd.

Blk 4008 Ang Mo Kio Avenue 10
#04-01/02 Techplace I
Singapore 569625
Tel +65 6 555 5885
Fax +65 6 555 5995
info@erni-asia.com

Asia Australia New Zealand

© ERNI Electronics GmbH & Co. KG 2016 • Printed in Germany • A policy of continuous improvement is followed and the right to alter any published data without notice is reserved.

ERNI®, ERNI WoR&D®, Act. Connect. Perfect®, MicroCon®, MicroStac®, MicroSpeed®, MiniBridge®, MaxiBridge®, ERmet®, ERmet ZD®, ERmet ZDplus®, ERmet ZD HD®, ERbic®, ERNIPRESS®, INTERact®, BLUEcontact® and WHITEspeed® are trademarks (registered or applied for in various countries) of ERNI Electronics GmbH & Co. KG.

单击下面可查看定价，库存，交付和生命周期等信息

[>>ERNI](#)