

# THJ Series



## High Temperature Tantalum Chip Capacitor



### FEATURES

- Improved reliability – 2x standard
- 175°C @ 0.5V<sub>R</sub> continuous operation
- CV range: 0.10-220µF / 6.3-50V
- 5 case sizes available
- Low ESR options on approval
- High temperature automotive and industry applications

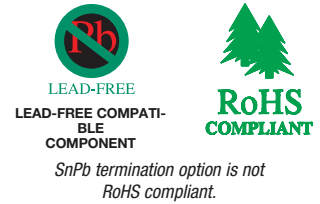

### APPLICATIONS

- Automotive ECU and ABS control electronics
- Geothermal instrumentation

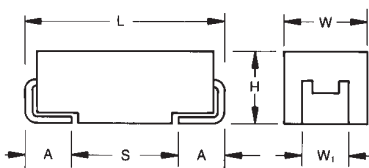

### CASE DIMENSIONS: millimeters (inches)

Code	EIA Code	EIA Metric	L±0.20 (0.008)	W+0.20 (0.008) -0.10 (0.004)	H+0.20 (0.008) -0.10 (0.004)	W <sub>1</sub> ±0.20 (0.008)	A+0.30 (0.012) -0.20 (0.008)	S Min.
A	1206	3216-18	3.20 (0.126)	1.60 (0.063)	1.60 (0.063)	1.20 (0.047)	0.80 (0.031)	1.10 (0.043)
B	1210	3528-21	3.50 (0.138)	2.80 (0.110)	1.90 (0.075)	2.20 (0.087)	0.80 (0.031)	1.40 (0.055)
C	2312	6032-28	6.00 (0.236)	3.20 (0.126)	2.60 (0.102)	2.20 (0.087)	1.30 (0.051)	2.90 (0.114)
D	2917	7343-31	7.30 (0.287)	4.30 (0.169)	2.90 (0.114)	2.40 (0.094)	1.30 (0.051)	4.40 (0.173)
E	2917	7343-43	7.30 (0.287)	4.30 (0.169)	4.10 (0.162)	2.40 (0.094)	1.30 (0.051)	4.40 (0.173)

W<sub>1</sub> dimension applies to the termination width for A dimensional area only.

### MARKING A, B, C, D, E CASE

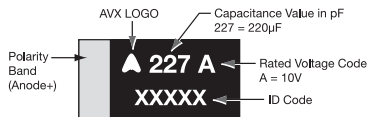

### HOW TO ORDER

THJ	B	105	*	035	R	JN	-
<b>Type</b>	<b>Case Size</b> See table above	<b>Capacitance Code</b> pF code: 1st two digits represent significant figures 3rd digit represents multiplier (number of zeros to follow)	<b>Tolerance</b> K=±10% M=±20%	<b>Rated DC Voltage</b> 006=6.3Vdc 010=10Vdc 016=16Vdc 020=20Vdc 025=25Vdc 035=35Vdc 050=50Vdc	<b>Packaging</b> R = Pure Tin 7" Reel S = Pure Tin 13" Reel A = Gold Plating 7" Reel (Contact Manufacturer) B = Gold Plating 13" Reel (Contact Manufacturer) H = Tin Lead 7" Reel (Contact Manufacturer) K = Tin Lead 13" Reel (Contact Manufacturer) H, K = Non RoHS	<b>Standard Suffix</b> OR <b>0100</b> Low ESR in mΩ	<b>Additional characters may be added for special requirements</b> V = Dry pack Option

### TECHNICAL SPECIFICATIONS

Technical Data:	All technical data relate to an ambient temperature of +25°C							
Capacitance Range:	0.10 µF to 220 µF							
Capacitance Tolerance:	±10%; ±20%							
Rated Voltage (V <sub>R</sub> )	≤ +85°C:	6.3	10	16	20	25	35	50
Category Voltage (V <sub>C</sub> )	≤ +125°C:	4	7	10	13	17	23	33
Category Voltage (V <sub>C</sub> )	≤ +175°C:	3	5	8	10	12	17	25
Surge Voltage (V <sub>S</sub> )	≤ +85°C:	8	13	20	26	32	46	65
Surge Voltage (V <sub>S</sub> )	≤ +125°C:	5	8	13	16	20	28	40
Surge Voltage (V <sub>S</sub> )	≤ +175°C:	4	6	10	12	15	21	30
Temperature Range:	-55°C to 175°C voltage derating.							
Reliability:	0.5% per 1000 hours at 85°C, V <sub>R</sub> with 0.1Ω/V series impedance, 60% confidence level, 3.5 Fits at 40°C, 0.5V <sub>R</sub>							
Termination Finish:	Sn Plating (standard), Gold and SnPb Plating upon request Meets requirements of AEC-Q200							



# THJ Series



## High Temperature Tantalum Chip Capacitor

### CAPACITANCE AND RATED VOLTAGE RANGE (LETTER DENOTES CASE SIZE)

Capacitance		Rated voltage ( $V_R$ ) to 85°C (Voltage Code)						
$\mu\text{F}$	Code	6.3V (J)	10V (A)	16V (C)	20V (D)	25V (E)	35V (V)	50V (T)
0.10	104						A	
0.15	154						A	
0.22	224						A	
0.33	334						A	
0.47	474					A	B	
0.68	684					A	B	
1.0	105						A/B	
1.5	155				A		C	
2.2	225			A, A(1500)		B, B(1500)	C	
3.3	335		A	A	B		C	D
4.7	475	A	A	A/B			C	D
6.8	685	A	A	A/B		C	D	D
10	106	A	A/B	B		C	D	D/E
15	156	B	B	B	C		D	
22	226	B	B	C, C(500)		D	D, D(300)	
33	336	B	C	C	D	D	E, E(150)	
47	476	C	C	C/D				
68	686	C	D	D				
100	107	D	D	E				
150	157	D						
220	227		E					

Released ratings, (ESR ratings in mOhms in parentheses)

Note: Voltage ratings are minimum values. AVX reserves the right to supply higher voltage ratings in the same case size, to the same reliability standards.

THJ 175°C Voltage vs Temperature Rating

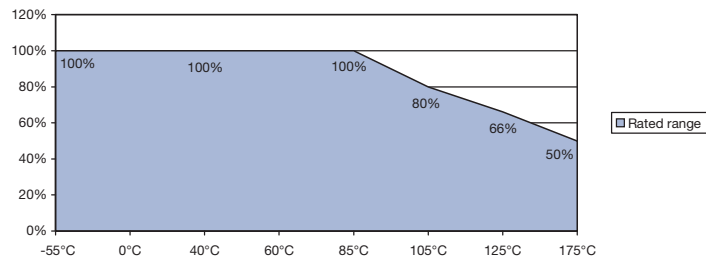

# THJ Series



## High Temperature Tantalum Chip Capacitor

### RATINGS & PART NUMBER REFERENCE

AVX Part No.	Case Size	Capacitance (µF)	Rated Voltage (V)	Rated Temperature (°C)	Category Voltage (V)	Category Temperature (°C)	DCL Max. (µA)	DF Max. (%)	ESR Max. @ 100kHz (Ω)	100kHz RMS Current (mA)				MSL
										25°C	85°C	125°C	175°C	
<b>6.3 Volt @ 85°C</b>														
THJA475*006#JN	A	4.7	6.3	85	3	175	0.5	6	6	112	101	45	22	1
THJA685*006#JN	A	6.8	6.3	85	3	175	0.5	4.5	2.6	170	153	68	34	1
THJA106*006#JN	A	10	6.3	85	3	175	0.6	4.5	2.2	185	166	74	37	1
THJB156*006#JN	B	15	6.3	85	3	175	0.9	6	2.5	184	166	74	37	1
THJB226*006#JN	B	22	6.3	85	3	175	1.4	6	2.5	184	166	74	37	1
THJB336*006#JN	B	33	6.3	85	3	175	1.9	6	2.2	197	177	79	39	1
THJC476*006#JN	C	47	6.3	85	3	175	3.0	6	1.6	262	236	105	52	1
THJC686*006#JN	C	68	6.3	85	3	175	4.3	6	1.5	271	244	108	54	1
THJD107*006#JN	D	100	6.3	85	3	175	6	4.5	0.4	612	551	245	122	1 <sup>1)</sup>
THJD157*006#JN	D	150	6.3	85	3	175	9.5	6	0.9	408	367	163	82	1 <sup>1)</sup>
<b>10 Volt @ 85°C</b>														
THJA335*010#JN	A	3.3	10	85	5	175	0.5	6	5.5	117	105	47	23	1
THJA475*010#JN	A	4.7	10	85	5	175	0.5	4.5	2.9	161	145	64	32	1
THJA685*010#JN	A	6.8	10	85	5	175	0.7	4.5	2.6	170	153	68	34	1
THJA106*010#JN	A	10	10	85	5	175	1	6	2.7	167	150	67	33	1
THJB106*010#JN	B	10	10	85	5	175	1	4.5	1.8	217	196	87	43	1
THJB156*010#JN	B	15	10	85	5	175	1.5	4.5	1.5	238	214	95	48	1
THJB226*010#JN	B	22	10	85	5	175	2.2	6	2.4	188	169	75	38	1
THJC336*010#JN	C	33	10	85	5	175	3.3	6	1.6	262	236	105	52	1
THJC476*010#JN	C	47	10	85	5	175	4.7	4.5	0.5	469	422	188	94	1
THJD686*010#JN	D	68	10	85	5	175	6.8	4.5	0.4	612	551	245	122	1 <sup>1)</sup>
THJD107*010#JN	D	100	10	85	5	175	10	6	0.9	408	367	163	82	1 <sup>1)</sup>
THJE227*010#JN	E	220	10	85	5	175	22	10	0.5	574	517	230	115	1 <sup>1)</sup>
<b>16 Volt @ 85°C</b>														
THJA225*016#JN	A	2.2	16	85	8	175	0.5	4.5	3	158	142	63	32	1
THJA225*016#1500	A	2.2	16	85	8	175	0.5	4.5	1.5	224	201	89	45	1
THJA335*016#JN	A	3.3	16	85	8	175	0.5	6	5	122	110	49	24	1
THJA475*016#JN	A	4.7	16	85	8	175	0.8	4.5	2.9	161	145	64	32	1
THJB475*016#JN	B	4.7	16	85	8	175	0.8	6	3.5	156	140	62	31	1
THJA685*016#JN	A	6.8	16	85	8	175	1.1	6	3.5	146	132	59	29	1
THJB685*016#JN	B	6.8	16	85	8	175	1.1	6	2.5	184	166	74	37	1
THJB106*016#JN	B	10	16	85	8	175	1.6	4.5	2.8	174	157	70	35	1
THJB156*016#JN	B	15	16	85	8	175	2.4	6	2	206	186	82	41	1
THJC226*016#JN	C	22	16	85	8	175	3.5	6	1.6	262	236	105	52	1
THJC226*016#0500	C	22	16	85	8	175	3.5	4.5	0.5	469	422	188	94	1
THJC336*016#JN	C	33	16	85	8	175	5.3	6	1.5	271	244	108	54	1
THJC476*016#JN	C	47	16	85	8	175	7.5	6	0.9	371	334	148	74	1
THJD476*016#JN	D	47	16	85	8	175	7.5	6	0.9	408	367	163	82	1 <sup>1)</sup>
THJD686*016#JN	D	68	16	85	8	175	10.9	4.5	0.9	408	367	163	82	1 <sup>1)</sup>
THJE107*016#JN	E	100	16	85	8	175	16	8	0.4	642	578	257	128	1 <sup>1)</sup>
<b>20 Volt @ 85°C</b>														
THJA155*020#JN	A	1.5	20	85	10	175	0.5	6	6.5	107	97	43	21	1
THJB335*020#JN	B	3.3	20	85	10	175	0.7	6	3	168	151	67	34	1
THJC156*020#JN	C	15	20	85	10	175	3.0	6	1.7	254	229	102	51	1
THJD336*020#JN	D	33	20	85	10	175	6.6	6	0.9	408	367	163	82	1 <sup>1)</sup>
<b>25 Volt @ 85°C</b>														
THJA474*025#JN	A	0.47	25	85	12	175	0.5	4	14	73	66	29	15	1
THJA684*025#JN	A	0.68	25	85	12	175	0.5	4	10	87	78	35	17	1
THJA105*025#JN	A	1.0	25	85	12	175	0.5	3	5.2	120	108	48	24	1
THJB225*025#JN	B	2.2	25	85	12	175	0.6	6	4.5	137	124	55	27	1
THJB225*025#1500	B	2.2	25	85	12	175	0.6	6	1.5	238	214	95	48	1
THJC685*025#JN	C	6.8	25	85	12	175	1.7	6	2	235	211	94	47	1
THJC106*025#JN	C	10	25	85	12	175	2.5	6	1.8	247	222	99	49	1
THJD226*025#JN	D	22	25	85	12	175	5.5	6	0.9	408	367	163	82	1 <sup>1)</sup>
THJD336*025#JN	D	33	25	85	12	175	8.3	6	0.9	408	367	163	82	1 <sup>1)</sup>
<b>35 Volt @ 85°C</b>														
THJA104*035#JN	A	0.1	35	85	17	175	0.5	4	24	56	50	22	11	1
THJA154*035#JN	A	0.15	35	85	17	175	0.5	4	21	60	54	24	12	1
THJA224*035#JN	A	0.22	35	85	17	175	0.5	4	18	65	58	26	13	1
THJA334*035#JN	A	0.33	35	85	17	175	0.5	4	15	71	64	28	14	1
THJB474*035#JN	B	0.47	35	85	17	175	0.5	4	10	92	83	37	18	1
THJB684*035#JN	B	0.68	35	85	17	175	0.5	4	8	103	93	41	21	1
THJA105*035#JN	A	1.0	35	85	17	175	0.5	4	7.5	100	90	40	20	1
THJB105*035#JN	B	1.0	35	85	17	175	0.5	4	6.5	114	103	46	23	1
THJC155*035#JN	C	1.5	35	85	17	175	0.5	6	4.5	156	141	63	31	1
THJC225*035#JN	C	2.2	35	85	17	175	0.8	6	3.5	177	160	71	35	1
THJC335*035#JN	C	3.3	35	85	17	175	1.2	6	2.5	210	189	84	42	1
THJC475*035#JN	C	4.7	35	85	17	175	1.6	6	2.2	224	201	89	45	1
THJD685*035#JN	D	6.8	35	85	17	175	2.4	6	1.3	340	306	136	68	1 <sup>1)</sup>

### RATINGS & PART NUMBER REFERENCE

AVX Part No.	Case Size	Capacitance (μF)	Rated Voltage (V)	Rated Temperature (°C)	Category Voltage (V)	Category Temperature (°C)	DCL Max. (μA)	DF Max. (%)	ESR Max. @ 100kHz (Ω)	100kHz RMS Current (mA)				MSL
										25°C	85°C	125°C	175°C	
THJD106*035#JN	D	10	35	85	17	175	3.5	6	1	387	349	155	77	1 <sup>1)</sup>
THJD156*035#JN	D	15	35	85	17	175	5.3	6	0.9	408	367	163	82	1 <sup>1)</sup>
THJD226*035#JN	D	22	35	85	17	175	7.7	6	0.6	500	450	200	100	1 <sup>1)</sup>
THJD226*035#0300	D	22	35	85	17	175	7.7	6	0.3	707	636	283	141	1 <sup>1)</sup>
THJE336*035#JN	E	33	35	85	17	175	11.6	6	0.5	574	517	230	115	1 <sup>1)</sup>
THJE336*035#0150	E	33	35	85	17	175	11.6	6	0.15	1049	944	420	210	1 <sup>1)</sup>
<b>50 Volt @ 85°C</b>														
THJD335*050#JN	D	3.3	50	85	25	175	1.7	6	1.1	369	332	148	74	1 <sup>1)</sup>
THJD475*050#JN	D	4.7	50	85	25	175	2.4	6	0.9	463	417	185	93	1 <sup>1)</sup>
THJD685*050#JN	D	6.8	50	85	25	175	3.4	6	0.7	408	367	163	82	1 <sup>1)</sup>
THJD106*050#JN	D	10	50	85	25	175	5	6	0.7	463	417	185	93	1 <sup>1)</sup>
THJE106*050#JN	E	10	50	85	25	175	5	6	0.7	486	437	194	97	1 <sup>1)</sup>

Moisture Sensitivity Level (MSL) is defined according to J-STD-020.

All PNs also available with Dry pack option - MSL 3 (see How to order).

<sup>1)</sup> -Dry pack option (see How to order) is recommended for reduction of stress during soldering.

All technical data relates to an ambient temperature of +25°C. Capacitance and DF are measured at 120Hz, 0.5V RMS with a maximum DC bias of 2.2 volts. DCL is measured at rated voltage after 5 minutes.

The EIA & CECC standards for low ESR Solid Tantalum Capacitors allow an ESR movement to 1.25 times catalogue limit post mounting.

For typical weight and composition see page 273.

**NOTE: AVX reserves the right to supply higher voltage ratings or tighter tolerance part in the same case size, to the same reliability standards.**

### QUALIFICATION TABLE

TEST	THJ series (Temperature range -55°C to +175°C)										
	Condition			Characteristics							
<b>Endurance</b>	Apply rated voltage (Ur) at 85°C and / or category voltage (Uc) at 175°C for 2000 hours through a circuit impedance of $\leq 0.1\Omega/V$ . Stabilize at room temperature for 1-2 hours before measuring.			Visual examination	no visible damage						
				DCL	1.25 x initial limit						
				$\Delta C/C$	within $\pm 10\%$ of initial value						
				DF	initial limit						
				ESR	1.25 x initial limit						
<b>Storage Life</b>	Store at 175°C, no voltage applied, for 2000 hours. Stabilize at room temperature for 1-2 hours before measuring.			Visual examination	no visible damage						
				DCL	1.25 x initial limit						
				$\Delta C/C$	within $\pm 10\%$ of initial value						
				DF	initial limit						
				ESR	1.25 x initial limit						
<b>Biased Humidity</b>	Apply rated voltage (Ur) at 85°C, 85% relative humidity for 1000 hours. Stabilize at room temperature and humidity for 1-2 hours before measuring.			Visual examination	no visible damage						
				DCL	2 x initial limit						
				$\Delta C/C$	within $\pm 10\%$ of initial value						
				DF	1.2 x initial limit						
				ESR	1.25 x initial limit						
<b>Temperature Stability</b>	Step	Temperature°C	Duration(min)		+20°C	-55°C	+20°C	+125°C	+175°C	+20°C	
	1	+20	15	DCL	IL*	n/a	IL*	10 x IL*	12.5 x IL*	IL*	
	2	-55	15		$\Delta C/C$	n/a	+0/-10%	$\pm 5\%$	+10/-0%	+18/-0%	$\pm 5\%$
	3	+20	15	DF		IL*	1.5 x IL*	IL*	1.5 x IL*	2 x IL*	IL*
	4	+125	15		ESR	1.25 x IL*	2.5 x IL*	1.25 x IL*	1.25 x IL*	1.25 x IL*	1.25 x IL*
	5	+175	15								
	6	+20	15								
<b>Surge Voltage</b>	Apply 1.3x category voltage (Uc) at 175°C for 1000 cycles of duration 6 min (30 sec charge, 5 min 30 sec discharge) through a charge / discharge resistance of 1000 $\Omega$ .			Visual examination	no visible damage						
				DCL	initial limit						
				$\Delta C/C$	within $\pm 5\%$ of initial value						
				DF	initial limit						
				ESR	1.25 x initial limit						
<b>Mechanical Shock</b>	MIL-STD-202, Method 213, Condition F			Visual examination	no visible damage						
				DCL	initial limit						
				$\Delta C/C$	within $\pm 5\%$ of initial value						
				DF	initial limit						
				ESR	1.25 x initial limit						
<b>Vibration</b>	MIL-STD-202, Method 204, Condition D			Visual examination	no visible damage						
				DCL	initial limit						
				$\Delta C/C$	within $\pm 5\%$ of initial value						
				DF	initial limit						
				ESR	1.25 x initial limit						

\*Initial Limit

### AVX SOLID ELECTROLYTIC CAPACITOR ROADMAP

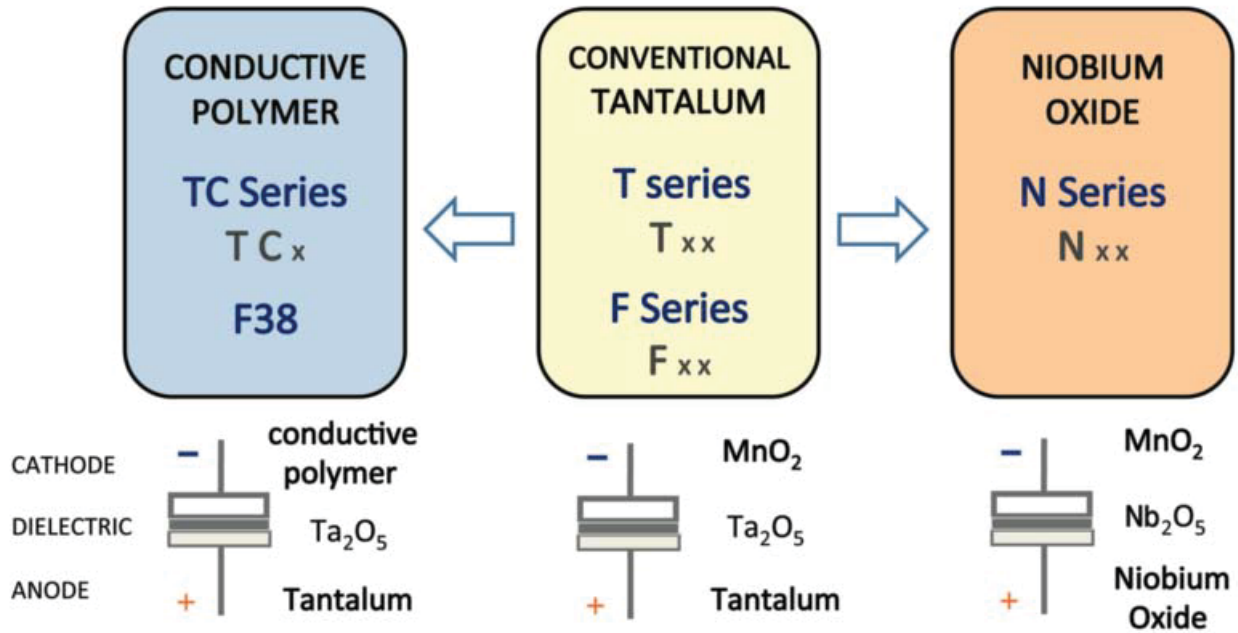

### Five Capacitor Construction Styles

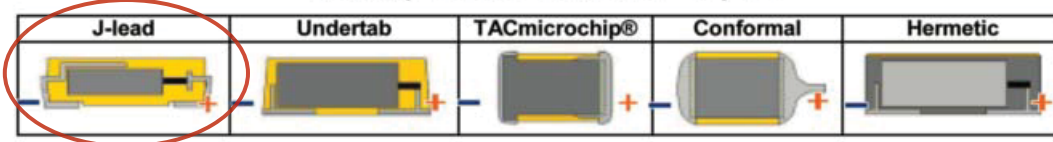

### SERIES LINE UP: CONVENTIONAL SMD MnO<sub>2</sub>

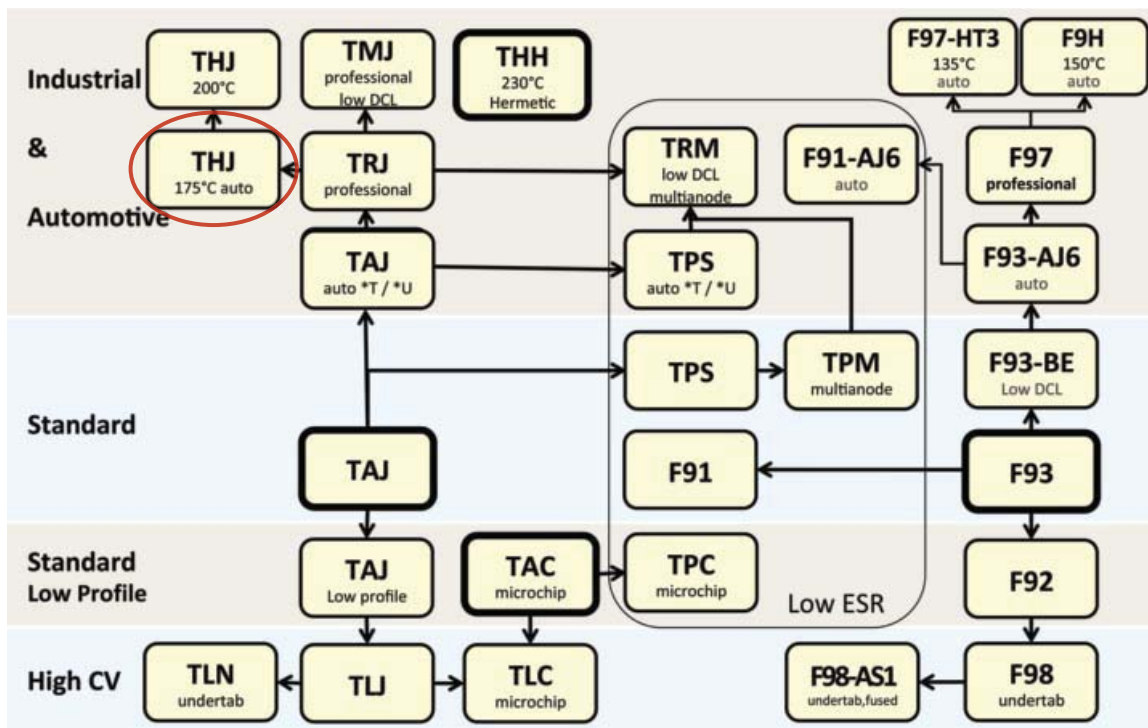

单击下面可查看定价，库存，交付和生命周期等信息

[>>AVX](#)

[>>点击查看相关商品](#)