

## HiSAT-COT® Control, 1.5A Synchronous Step-Down DC/DC Converters

☆GreenOperation-compatible

### ■ GENERAL DESCRIPTION

The XC9260/XC9261 series is a group of synchronous-rectification type DC/DC converters with a built-in P-channel MOS driver transistor and N-channel MOS switching transistor, designed to allow the use of ceramic capacitors. Output voltage is internally set in a range from 0.8V to 3.6V (accuracy:  $\pm 2.0\%$ ) increments of 0.05V. The device provides a high efficiency, stable power supply with an output current of 1.5A to be configured using only a coil and two capacitors connected externally. Oscillation frequency is set to 1.2MHz or 3.0MHz can be selected for suiting to your particular application.

As for operation mode HiSAT-COT<sup>(\*)</sup> control excellent in transient response, the XC9260 series is PWM control, the XC9261 series is automatic PWM/PFM switching control, allowing fast response, low ripple and high efficiency over the full range of loads (from light load to heavy load).

During stand-by, all circuits are shutdown to reduce current consumption to as low as 1.0  $\mu\text{A}$  or less. As for the soft-start function as fast as 0.3ms in typical for quick turn-on. With the built-in UVLO (Under Voltage Lock Out) function, the internal P-channel MOS driver transistor is forced OFF when input voltage becomes 2.00V or lower. The B types integrate  $C_L$  High Speed discharge function which enables the electric charge at the output capacitor  $C_L$  to be discharged via the internal discharge.

Two types of package SOT-89-5, USP-6C are available.

<sup>(\*)</sup>HiSAT-COT is DC/DC converter with proprietary high-speed transient response technology developed uniquely by Torex, ideal for LSI that require high precision and high stability power supply voltage.

### ■ APPLICATIONS

- Communication equipment / Communication Module  
(Bluetooth/Wi-Fi/GPS)
- MCU/FPGA/ASIC for power supplies (POL)
- Smart phones / Mobile phones
- DSC/Camcorder

### ■ FEATURES

Input Voltage Range	: 2.7V~5.5V
Output Voltage Range	: 0.8V~3.6V ( $\pm 2.0\%$ )
Quiescent Current	: 25 $\mu\text{A}$ ( $f_{\text{osc}}=3.0\text{MHz}$ )
Output Current	: 1.5A
Oscillation Frequency	: 1.2MHz, 3.0MHz
Efficiency	: 90% ( $V_{\text{IN}}=3.7\text{V}$ , $V_{\text{OUT}}=1.8\text{V}$ , $I_{\text{OUT}}=200\text{mA}$ )
Control Methods	: HiSAT-COT Control : 100% Duty Cycle : PWM Control (XC9260) : PWM/PFM Auto (XC9261)
Protection Circuits	: Thermal Shutdown : Current Limit (Pendent character) : Short Circuit Protection (Type B)
Functions	: Soft-Start : UVLO : $C_L$ High Speed Discharge (Type B)
Capacitor	: Ceramic Capacitor
Operating Ambient Temperature	: $-40^\circ\text{C} \sim +105^\circ\text{C}$
Packages	: SOT-89-5, USP-6C
Environmentally Friendly	: EU RoHS Compliant, Pb Free

### ■ TYPICAL APPLICATION CIRCUIT

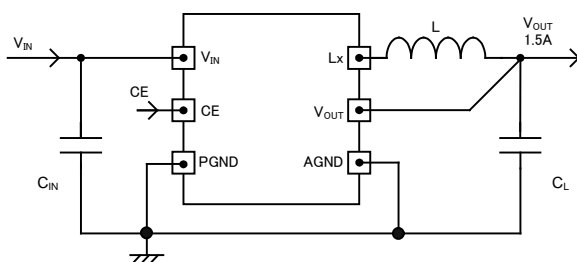

### ■ TYPICAL PERFORMANCE CHARACTERISTICS

XC9260A18D / XC9261A18D

$L = \text{LQM2MPN1R0MGH}(1.0 \mu\text{H})$   
 $C_{\text{IN}}=10 \mu\text{F}(\text{GRM155R61A106M})$   $C_{\text{L}}=10 \mu\text{F}(\text{GRM155R61A106M})$

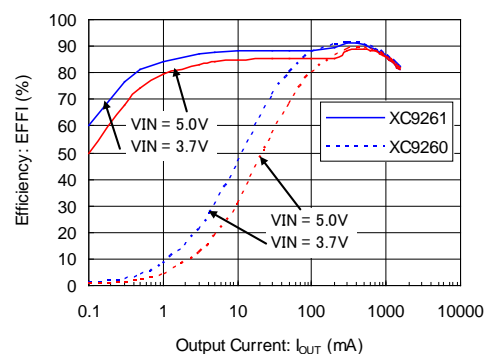

## BLOCK DIAGRAM

1) XC9260/XC9261 Series Type A (SOT-89-5)

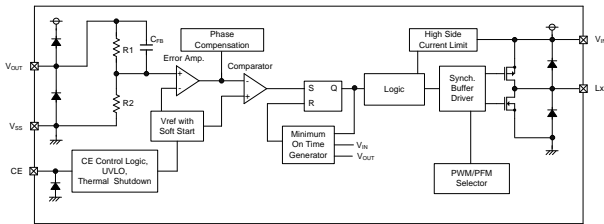

2) XC9260/XC9261 Series Type B (SOT-89-5)

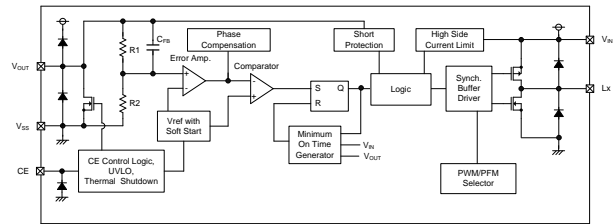

(\*) The XC9260 offers a fixed PWM control, a Control Logic of PWM/PFM Selector is fixed at "PWM" internally.

The XC9261 control scheme is a fixed PWM/PFM automatic switching, a Control Logic of PWM/PFM Selector is fixed at "PWM/PFM automatic switching" internally.

Diodes inside the circuit are an ESD protection diode and a parasitic diode.

3) XC9260/XC9261 Series Type A (USP-6C)

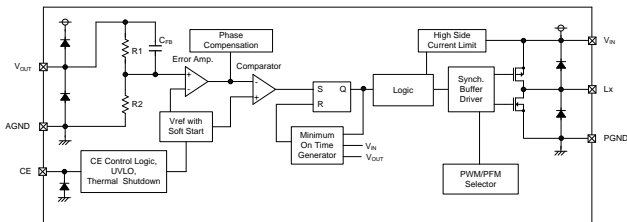

4) XC9260/XC9261 Series Type B (USP-6C)

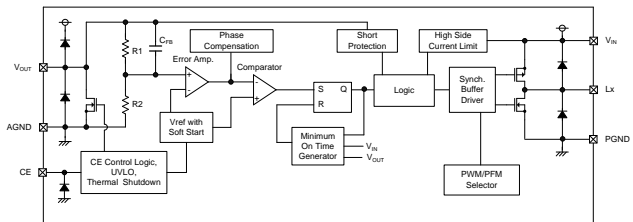

(\*) The XC9260 offers a fixed PWM control, a Control Logic of PWM/PFM Selector is fixed at "PWM" internally.

The XC9261 control scheme is a fixed PWM/PFM automatic switching, a Control Logic of PWM/PFM Selector is fixed at "PWM/PFM automatic switching" internally.

Diodes inside the circuit are an ESD protection diode and a parasitic diode.

## ■ PRODUCT CLASSIFICATION

### 1) Ordering Information

XC9260①②③④⑤⑥-⑦ PWM Control

XC9261①②③④⑤⑥-⑦ PWM/PFM Automatic switching control

DESIGNATOR	ITEM	SYMBOL	DESCRIPTION
①	Type	A	Refer to Selection Guide
		B	
②③	Output Voltage	08~36	Output voltage options e.g. 1.2V → ②=1, ③=2 1.25V → ②=1, ③=C 0.05V increments : 0.05=A, 0.15=B, 0.25=C, 0.35=D, 0.45=E, 0.55=F, 0.65=H, 0.75=K, 0.85=L, 0.95=M
④	Oscillation Frequency	C	1.2MHz
		D	3.0MHz
⑤⑥-⑦ <sup>(*)</sup>	Packages (Order Unit)	PR-G	SOT-89-5 (1,000pcs/Reel)
		ER-G	USP-6C (3,000pcs/Reel)

(\*) The "G" suffix denotes Halogen and Antimony free as well as being fully EU RoHS compliant.

### 2) Selection Guide

TYPE	OUTPUT VOLTAGE	C <sub>L</sub> AUTO-DISCHARGE	SHORT PROTECTION (LATCH)	UVLO
A	Fixed	No	No	Yes
B	Fixed	Yes	Yes	Yes

TYPE	CHIP ENABLE	CURRENT LIMIT	SOFT-START TIME	THERMAL SHUTDOWN
A	Yes	Yes	Fixed	Yes
B	Yes	Yes	Fixed	Yes

## PIN CONFIGURATION

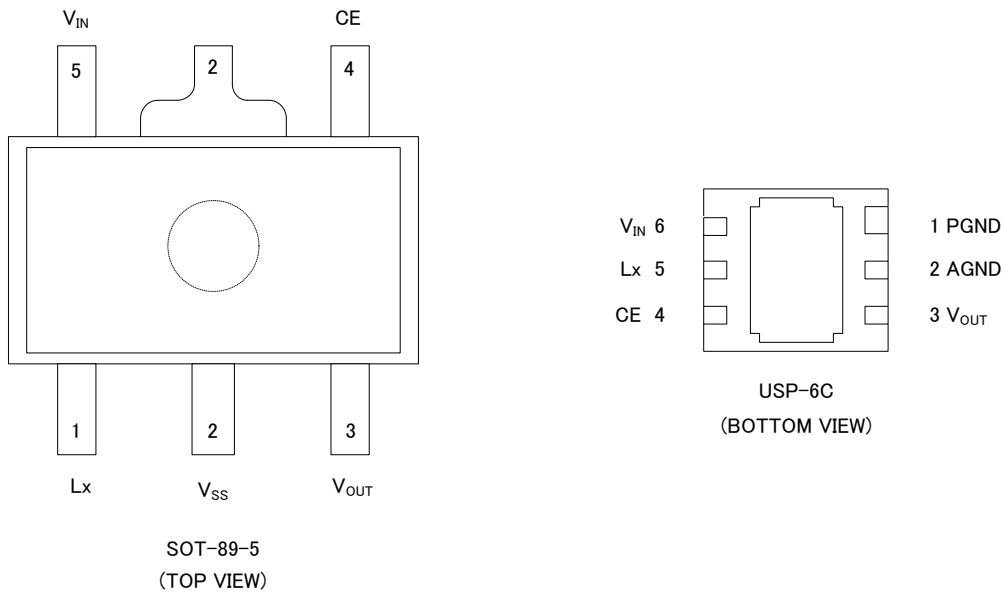

\* The dissipation pad for the USP-6C package should be solder-plated in recommended mount pattern and metal masking so as to enhance mounting strength and heat release. If the pad needs to be connected to other pins, it should be connected to the GND (No. 1 and 2) pin.

## PIN ASSIGNMENT

PIN NUMBER		PIN NAME	FUNCTIONS
SOT-89-5	USP-6C		
1	5	Lx	Switching Output
2	-	$V_{SS}$	Ground
3	3	$V_{OUT}$	Output Voltage Monitor
4	4	CE	Chip Enable
5	6	$V_{IN}$	Power Input
-	2	AGND	Analog Ground
-	1	PGND	Power Ground

## FUNCTION

CE PIN Function

PIN NAME	SIGNAL	STATUS
CE	L	Stand-by
	H	Active

Please do not leave the CE pin open.

## ■ ABSOLUTE MAXIMUM RATINGS

Ta=25°C

PARAMETER		SYMBOL	RATINGS	UNITS
VIN Pin Voltage		V <sub>IN</sub>	-0.3~+6.2	V
Lx PIN Voltage		V <sub>Lx</sub>	-0.3~V <sub>IN</sub> +0.3 or +6.2 <sup>(1)</sup>	V
V <sub>OUT</sub> Pin Voltage		V <sub>OUT</sub>	-0.3~V <sub>IN</sub> +0.3 or +4.0 <sup>(2)</sup>	V
CE Pin Voltage		V <sub>CE</sub>	-0.3~+6.2	V
Power Dissipation	SOT-89-5	P <sub>d</sub>	500	mW
			1300 (40mm x 40mm standard board) <sup>(3)</sup>	
			1750 (JESD51-7 board) <sup>(3)</sup>	
	USP-6C		120	
			1000 (40mm x 40mm standard board) <sup>(3)</sup>	
			1250(JESD51-7 board) <sup>(3)</sup>	
Operating Ambient Temperature		T <sub>opr</sub>	-40~+105	°C
Storage Temperature		T <sub>stg</sub>	-55~+125	°C

\* All voltages are described based on the GND (AGND and PGND and V<sub>SS</sub>) pin.

<sup>(1)</sup> The maximum value should be either V<sub>IN</sub>+0.3V or +6.2V in the lowest.

<sup>(2)</sup> The maximum value should be either V<sub>IN</sub>+0.3V or +4.0V in the lowest.

<sup>(3)</sup> The power dissipation figure shown is PCB mounted and is for reference only.

The mounting condition is please refer to PACKAGING INFORMATION.

## ELECTRICAL CHARACTERISTICS

XC9260/XC9261 Series

Ta=25°C

PARAMETER	SYMBOL	CONDITIONS	MIN.	TYP.	MAX.	UNITS	CIRCUIT	
Output Voltage	V <sub>OUT</sub>	When connected to external components, I <sub>OUT</sub> =30mA	<E-1>	<E-2>	<E-3>	V	①	
Operating Voltage Range	V <sub>IN</sub>	-	2.7	-	5.5	V	①	
Maximum Output Current	I <sub>OUTMAX</sub>	When connected to external components <sup>(*)</sup> . V <sub>IN</sub> = <C -1>	1500	-	-	mA	①	
UVLO Voltage <sup>(2)</sup>	V <sub>UVLO</sub>	V <sub>OUT</sub> =0.6V, Voltage which Lx pin holding "L" level <sup>(6)</sup>	1.35	2.0	2.68	V	③	
Quiescent Current (XC9261)	I <sub>q</sub>	V <sub>OUT</sub> =V <sub>OUT(T)</sub> × 1.1V	f <sub>OSC</sub> =1.2MHz	-	15.0	25.0	μA	②
			f <sub>OSC</sub> =3.0MHz	-	25.0	40.0		
Quiescent Current (XC9260)	I <sub>q</sub>	V <sub>OUT</sub> =V <sub>OUT(T)</sub> × 1.1V	f <sub>OSC</sub> =1.2MHz	-	250	450	μA	②
			f <sub>OSC</sub> =3.0MHz	-	400	825		
Stand-by Current	I <sub>STB</sub>	V <sub>CE</sub> =0.0V	-	0.0	1.0	μA	②	
Minimum ON time	t <sub>ONmin</sub>	When connected to external components, V <sub>IN</sub> = <C-1>, I <sub>OUT</sub> = 1mA	<E-5>	<E-6>	<E-7>	ns	①	
Thermal shutdown	T <sub>TSD</sub>	-	-	150	-	°C	①	
Thermal shutdown hysteresis	T <sub>HYS</sub>	-	-	30	-	°C	①	
Lx SW "H" ON Resistance	R <sub>LXH</sub>	V <sub>OUT</sub> =0.6V, I <sub>LX</sub> =100mA <sup>(3)</sup>	-	0.14	0.28	Ω	④	
Lx SW "L" ON Resistance <sup>(4)</sup>	R <sub>LXL</sub>	V <sub>OUT</sub> =V <sub>OUT(T)</sub> V × 1.1, I <sub>LX</sub> =100mA <sup>(3)</sup>	-	0.10	0.20	Ω	④	
Lx SW "H" Leakage Current	I <sub>LeakH</sub>	V <sub>IN</sub> =5.5V, V <sub>CE</sub> =0V, V <sub>OUT</sub> =0V, V <sub>LX</sub> =0.0V	-	0.0	1.0	μA	⑤	
Lx SW "L" Leakage Current	I <sub>LeakL</sub>	V <sub>IN</sub> =5.5V, V <sub>CE</sub> =0V, V <sub>OUT</sub> =0V, V <sub>LX</sub> =5.5V	-	0.0	30.0	μA	⑤	
Current Limit <sup>(5)</sup>	I <sub>LIMH</sub>	V <sub>OUT</sub> =0.6V, I <sub>LX</sub> until Lx pin oscillates	2.5	3.0	4.5	A	⑥	
Output Voltage Temperature Characteristics	ΔV <sub>OUT</sub> / (V <sub>OUT</sub> × ΔT <sub>opr</sub> )	I <sub>OUT</sub> =30mA, -40°C ≤ T <sub>opr</sub> ≤ 105°C	-	±100	-	ppm/°C	①	
CE "H" Voltage	V <sub>CEH</sub>	V <sub>OUT</sub> =0.6V, Applied voltage to V <sub>CE</sub> , Voltage changes Lx to "H" level <sup>(6)</sup>	1.40	-	V <sub>IN</sub>	V	③	
CE "L" Voltage	V <sub>CEL</sub>	V <sub>OUT</sub> =0.6V, Applied voltage to V <sub>CE</sub> , Voltage changes Lx to "L" level <sup>(6)</sup>	V <sub>SS</sub> <sup>(7)</sup>	-	0.30	V	③	
CE "H" Current	I <sub>CEH</sub>	V <sub>IN</sub> =5.5V, V <sub>CE</sub> =5.5V, V <sub>OUT</sub> =0.0V	-0.1	-	0.1	μA	⑤	
CE "L" Current	I <sub>CEL</sub>	V <sub>IN</sub> =5.5V, V <sub>CE</sub> =0.0V, V <sub>OUT</sub> =0.0V	-0.1	-	0.1	μA	⑤	
Soft-start Time	t <sub>SS</sub>	V <sub>CE</sub> =0.0V → 5.0V V <sub>OUT</sub> =V <sub>OUT(T)</sub> V × 0.9 After "H" is fed to CE, the time by when clocks are generated at Lx pin.	0.10	0.30	0.50	ms	③	
Short Protection Threshold Voltage (Type B)	V <sub>SHORT</sub>	Sweeping V <sub>OUT</sub> , V <sub>OUT</sub> voltage which Lx becomes "L" level <sup>(6)</sup>	0.17	0.27	0.37	V	③	
C <sub>L</sub> Discharge (Type B)	R <sub>DCHG</sub>	V <sub>CE</sub> =0V, V <sub>OUT</sub> =4.0V	50	210	300	Ω	⑦	

Unless otherwise stated, V<sub>IN</sub>=5V, V<sub>CE</sub>=5V, V<sub>OUT(T)</sub>=Nominal Value,

NOTE:

<sup>(1)</sup> When the difference between the input and the output is small, 100% duty might come up and internal control circuits keep P-ch driver turning on even though the output current is not so large.

If current is further pulled from this state, output voltage will decrease because of P-ch driver ON resistance.

<sup>(2)</sup> Including UVLO detect voltage, hysteresis operating voltage range for UVLO release voltage.

<sup>(3)</sup> R<sub>LXH</sub> = (V<sub>IN</sub> - Lx pin measurement voltage) / 100mA, R<sub>LXL</sub> = Lx pin measurement voltage / 100mA

<sup>(4)</sup> Design value for the XC9261 series.

<sup>(5)</sup> Current limit denotes the level of detection at peak of coil current.

<sup>(6)</sup> "H" = V<sub>IN</sub> - V<sub>IN</sub> - 1.2V, "L" = -0.1V ~ +0.1V

<sup>(7)</sup> AGND in the case of USP-6C.

## ■ ELECTRICAL CHARACTERISTICS (Continued)

SPEC Table

NOMINAL OUTPUT VOLTAGE	V <sub>OUT</sub>			t <sub>ONmin</sub>						
	<E-1>	<E-2>	<E-3>	<C-1>	f <sub>osc</sub> = 1.2MHz			f <sub>osc</sub> = 3.0MHz		
					<E-5>	<E-6>	<E-7>	<E-5>	<E-6>	<E-7>
V <sub>OUT(T)</sub>	MIN.	TYP.	MAX.	V <sub>IN</sub>	MIN.	TYP.	MAX.	MIN.	TYP.	MAX.
0.80	0.784	0.800	0.816	2.70	173	247	321	71	119	166
0.85	0.833	0.850	0.867	2.70	184	262	341	72	121	169
0.90	0.882	0.900	0.918	2.70	194	278	361	73	122	171
0.95	0.931	0.950	0.969	2.70	205	293	381	74	123	172
1.00	0.980	1.000	1.020	2.70	216	309	401	86	123	160
1.05	1.029	1.050	1.071	2.70	227	324	421	91	130	169
1.10	1.078	1.100	1.122	2.70	238	340	441	95	136	177
1.15	1.127	1.150	1.173	2.70	248	355	461	99	142	185
1.20	1.176	1.200	1.224	2.70	259	370	481	104	148	193
1.25	1.225	1.250	1.275	2.70	270	386	502	108	154	201
1.30	1.274	1.300	1.326	2.70	281	401	522	112	160	209
1.35	1.323	1.350	1.377	2.70	292	417	542	117	167	217
1.40	1.372	1.400	1.428	2.70	302	432	562	121	173	225
1.45	1.421	1.450	1.479	2.70	313	448	582	125	179	233
1.50	1.470	1.500	1.530	2.70	324	463	602	130	185	241
1.55	1.519	1.550	1.581	2.70	335	478	622	134	191	249
1.60	1.568	1.600	1.632	2.70	346	494	642	138	198	257
1.65	1.617	1.650	1.683	2.75	350	500	650	140	200	260
1.70	1.666	1.700	1.734	2.83	350	500	650	140	200	260
1.75	1.715	1.750	1.785	2.92	350	500	650	140	200	260
1.80	1.764	1.800	1.836	3.00	350	500	650	140	200	260
1.85	1.813	1.850	1.887	3.08	350	500	650	140	200	260
1.90	1.862	1.900	1.938	3.17	350	500	650	140	200	260
1.95	1.911	1.950	1.989	3.25	350	500	650	140	200	260
2.00	1.960	2.000	2.040	3.33	350	500	650	140	200	260
2.05	2.009	2.050	2.091	3.42	350	500	650	140	200	260
2.10	2.058	2.100	2.142	3.50	350	500	650	140	200	260
2.15	2.107	2.150	2.193	3.58	350	500	650	140	200	260
2.20	2.156	2.200	2.244	3.67	350	500	650	140	200	260
2.25	2.205	2.250	2.295	3.75	350	500	650	140	200	260
2.30	2.254	2.300	2.346	3.83	350	500	650	140	200	260
2.35	2.303	2.350	2.397	3.92	350	500	650	140	200	260
2.40	2.352	2.400	2.448	4.00	350	500	650	140	200	260
2.45	2.401	2.450	2.499	4.08	350	500	650	140	200	260
2.50	2.450	2.500	2.550	4.17	350	500	650	140	200	260
2.55	2.499	2.550	2.601	4.25	350	500	650	140	200	260
2.60	2.548	2.600	2.652	4.33	350	500	650	140	200	260
2.65	2.597	2.650	2.703	4.42	350	500	650	140	200	260
2.70	2.646	2.700	2.754	4.50	350	500	650	140	200	260

## ELECTRICAL CHARACTERISTICS (Continued)

SPEC Table

NOMINAL OUTPUT VOLTAGE	$V_{OUT}$			$V_{IN}$	$t_{ONmin}$						
	<E-1>	<E-2>	<E-3>		<C-1>	$f_{OSC}=1.2MHz$			$f_{OSC}=3.0MHz$		
	MIN.	TYP.	MAX.		MIN.	TYP.	MAX.	MIN.	TYP.	MAX.	
2.75	2.695	2.750	2.805	4.58	350	500	650	140	200	260	
2.80	2.744	2.800	2.856	4.67	350	500	650	140	200	260	
2.85	2.793	2.850	2.907	4.75	350	500	650	140	200	260	
2.90	2.842	2.900	2.958	4.83	350	500	650	140	200	260	
2.95	2.891	2.950	3.009	4.92	350	500	650	140	200	260	
3.00	2.940	3.000	3.060	5.00	350	500	650	140	200	260	
3.05	2.989	3.050	3.111	5.08	350	500	650	140	200	260	
3.10	3.038	3.100	3.162	5.17	350	500	650	140	200	260	
3.15	3.087	3.150	3.213	5.25	350	500	650	140	200	260	
3.20	3.136	3.200	3.264	5.33	350	500	650	140	200	260	
3.25	3.185	3.250	3.315	5.42	350	500	650	140	200	260	
3.30	3.234	3.300	3.366	5.50	350	500	650	140	200	260	
3.35	3.283	3.350	3.417	5.50	355	508	660	142	203	264	
3.40	3.332	3.400	3.468	5.50	361	515	670	144	206	268	
3.45	3.381	3.450	3.519	5.50	366	523	680	146	209	272	
3.50	3.430	3.500	3.570	5.50	371	530	689	148	212	276	
3.55	3.479	3.550	3.621	5.50	377	538	699	151	215	280	
3.60	3.528	3.600	3.672	5.50	382	545	709	153	218	284	



TEST CIRCUITS(\*1)

< Circuit No.① >

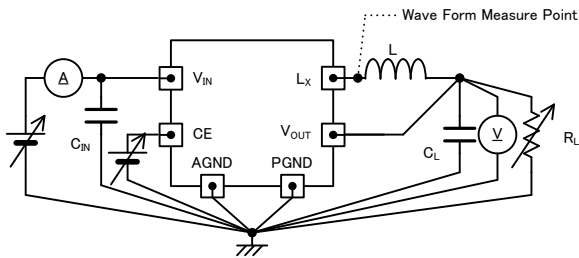

※ External Components

$f_{osc} = 1.2\text{MHz}$

$L : 4.7\ \mu\text{H}(\text{LTF5022T-4R7N2R0-LC})$

$C_{IN} : 10\ \mu\text{F}(\text{ceramic})$

$C_L : 10\ \mu\text{F}(\text{ceramic})$

※ External Components

$f_{osc} = 3.0\text{MHz}$

$L : 1.0\ \mu\text{H}(\text{LQM2MPN1R0MGH})$

$C_{IN} : 10\ \mu\text{F}(\text{ceramic})$

$C_L : 10\ \mu\text{F}(\text{ceramic})$

< Circuit No.② >

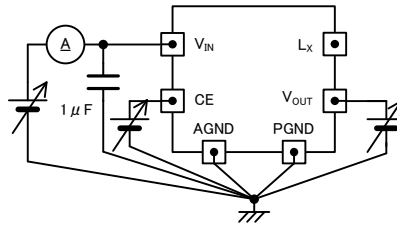

< Circuit No.③ >

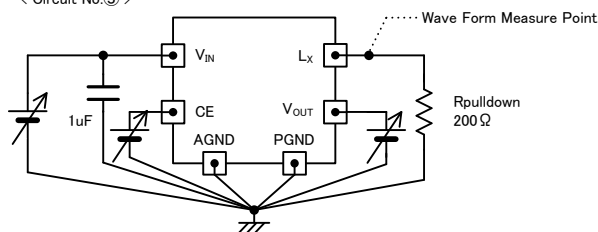

< Circuit No.④ >

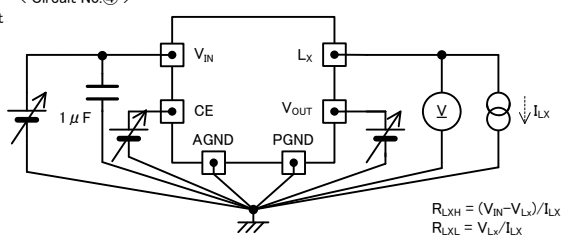

$$R_{LXH} = (V_{IN} - V_{LX}) / I_{LX}$$

$$R_{LXL} = V_{LX} / I_{LX}$$

< Circuit No.⑤ >

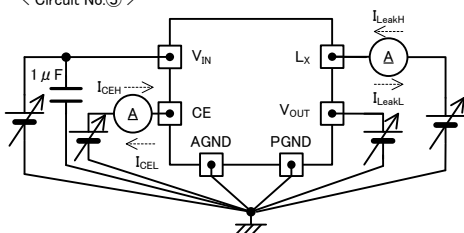

< Circuit No.⑥ >

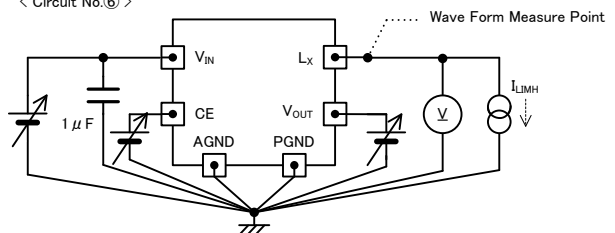

< Circuit No.⑦ >  
B TYPE

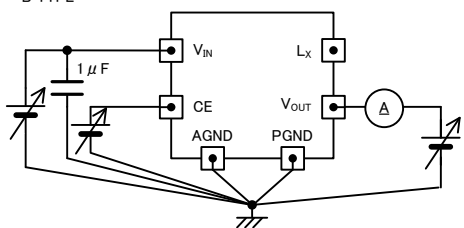

(\*1) In the case of SOT-89-5, AGND and PGND are treated as  $V_{SS}$ .

## TYPICAL APPLICATION CIRCUIT

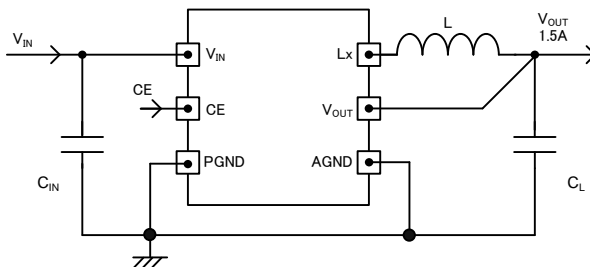

\* In the case of SOT-89-5, AGND and PGND are treated as  $V_{SS}$ .

【Typical Examples】  $f_{osc}=1.2\text{MHz}$

	MANUFACTURER	PRODUCT NUMBER	VALUE
L	murata	LQH5BPN4R7NT0L	4.7 $\mu\text{H}$
	TDK	LTF5022T-4R7N2R0-LC	4.7 $\mu\text{H}$
	Coilcraft	XFL4020-472MEC	4.7 $\mu\text{H}$

【Typical Examples】  $f_{osc}=3.0\text{MHz}$

	MANUFACTURER	PRODUCT NUMBER	VALUE
L	murata	LQM2MPN1R0MGH	1.0 $\mu\text{H}$
	TAIYO YUDEN	MAKK2016T1R0M	1.0 $\mu\text{H}$
	TDK	MLP2520K1R0M	1.0 $\mu\text{H}$

【Typical Examples】 <sup>(\*)</sup>  $f_{osc}=1.2\text{MHz}$ ,  $f_{osc}=3.0\text{MHz}$

	MANUFACTURER	PRODUCT NUMBER	VALUE
$C_{IN}$	murata	GRM155R61A106M	10 $\mu\text{F}/10\text{V}$
	murata	GRM21BR71A106KE51	10 $\mu\text{F}/10\text{V}$
	TAIYO YUDEN	LMK212AB7106MG	10 $\mu\text{F}/10\text{V}$
$C_L$	murata	GRM155R61A106M	10 $\mu\text{F}/10\text{V}$ <sup>(*)</sup>
	murata	GRM21BR71A106KE51	10 $\mu\text{F}/10\text{V}$ <sup>(*)</sup>
	TAIYO YUDEN	LMK212AB7106MG	10 $\mu\text{F}/10\text{V}$ <sup>(*)</sup>

<sup>(\*)</sup> Select components appropriate to the usage conditions (ambient temperature, input & output voltage).

<sup>(\*)</sup>  $C_L=20\mu\text{F}$  or more if  $V_{IN}-V_{OUT(T)}<1.5$

- The relationship between Output Voltage, Input Voltage, and  $C_L$  value

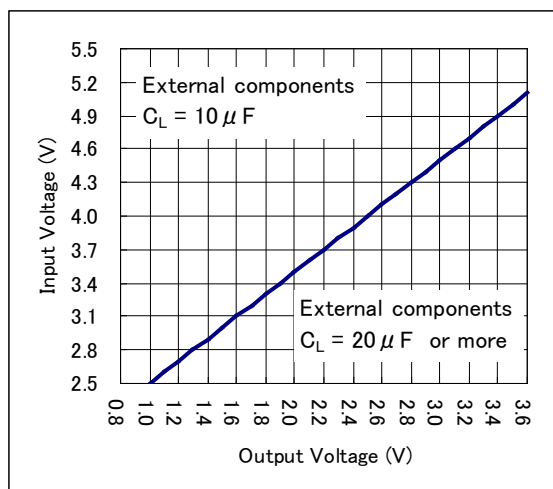

## OPERATIONAL EXPLANATION

The XC9260/XC9261 series consists of a reference voltage source, error amplifier, comparator, phase compensation, minimum on time generation circuit, output voltage adjustment resistors, P-channel MOS driver transistor, N-channel MOS switching transistor for the synchronous switch, current limiter circuit, UVLO circuit, thermal shutdown circuit, short protection circuit, PWM/PFM selection circuit and others. (See the BLOCK DIAGRAM below.)

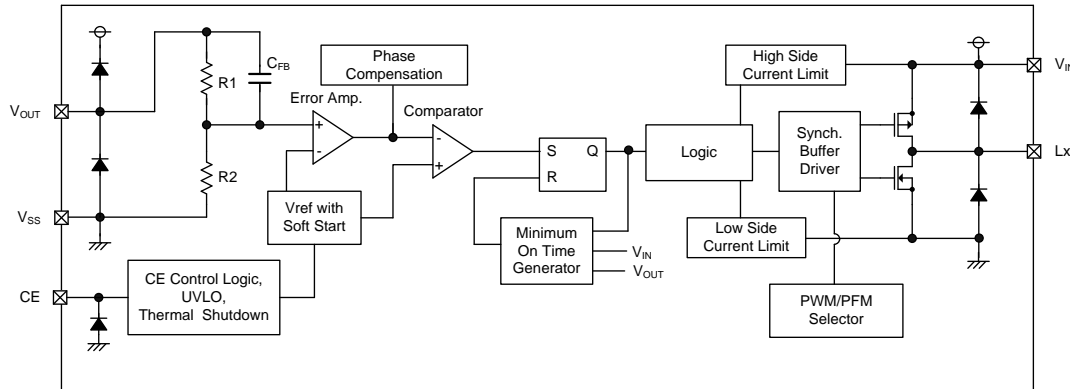

BLOCK DIAGRAM XC9260/XC9261 Series Type B (SOT-89-5)

The method is HiSAT-COT (High Speed circuit Architecture for Transient with Constant On Time) control, which features on time control method and a fast transient response that also achieves low output voltage ripple.

The on time ( $t_{on}$ ) is determined by the input voltage and output voltage, and turns on the Pch MOS driver Tr. for a fixed time. During the off time ( $t_{off}$ ), the voltage that is fed back through R1 and R2 is compared to the reference voltage by the error amp, and the error amp output is phase compensated and sent to the comparator. The comparator compares this signal to the reference voltage, and if the signal is lower than the reference voltage, sets the SR latch. On time then resumes. By doing this, PWM operation takes place with the off time controlled to the optimum duty ratio and the output voltage is stabilized. The phase compensation circuit optimizes the frequency characteristics of the error amp, and generates a ramp wave similar to the ripple voltage that occurs in the output to modulate the output signal of the error amp. This enables a stable feedback system to be obtained even when a low ESR capacitor such as a ceramic capacitor is used, and a fast transient response and stabilization of the output voltage are achieved.

### <Minimum on time generation circuit>

Generates an on time that depends on the input voltage and output voltage ( $t_{on}$ ). The on time is set as given by the equations below.

$$f_{OSC} \doteq 1.2\text{MHz type}$$

$$t_{on} (\mu\text{s}) = V_{OUT}/V_{IN} \times 0.833$$

$$f_{OSC} \doteq 3.0\text{MHz type}$$

$$t_{on} (\mu\text{s}) = V_{OUT}/V_{IN} \times 0.333$$

### <Switching frequency>

The switching frequency can be obtained from the on time ( $t_{on}$ ), which is determined by the input voltage and output voltage, and the PWM controlled off time ( $t_{off}$ ) as given by the equation below.

$$f_{OSC} (\text{MHz}) = V_{OUT}(V) / (V_{IN}(V) \times t_{on}(\mu\text{s}))$$

### <100% duty cycle mode>

When the load current is heavy and the voltage difference between input voltage and output voltage is small, 100% duty cycle mode is activated and it keeps the Pch MOS driver Tr. keep on. 100% duty cycle mode attains a high output voltage stability and a high-speed response under all load conditions, from light to heavy, even in conditions where the dropout voltage is low.

### <Error amp>

The error amp monitors the output voltage. The voltage divided by the internal R1 and R2 resistors is a feedback voltage for Error Amp. and compared to the reference voltage. The output voltage of the error amp becomes higher when the feedback voltage is higher than the reference voltage. The frequency characteristics of the error amp are optimized internally.

## OPERATIONAL EXPLANATION (Continued)

### <Reference voltage source, soft start function>

The reference voltage forms a reference that is used to stabilize the output voltage of the IC.

After “H” level is fed to CE pin, the reference voltage connected to the error amp increases linearly during the soft start interval. This allows the voltage divided by the internal R1 and R2 resistors and the reference voltage to be controlled in a balanced manner, and the output voltage rises in proportion to the rise in the reference voltage. This operation prevents rush input current and enables the output voltage to rise smoothly.

If the output voltage does not reach the set output voltage within the soft start time, such as when the load is heavy or a large capacity output capacitor is connected, the balancing of the voltage divided by the internal resistors R1 and R2 and the reference voltage is lost, however, the current restriction function activates to prevent an excessive increase of input current, enabling a smooth rise of the output voltage.

### <PWM/PFM selection circuit>

Regarding XC9260 which has PWM control method, it works with a continuous conduction mode, and operates at a stable switching frequency by means of an on time ( $t_{on}$ ) that is determined by the input voltage and output voltage regardless of the load.

Regarding XC9261 which has PWM/PFM auto switching control method, it works with a discontinuous conduction mode at light loads, and lowers the switching frequency to reduce switching loss and improve efficiency.

### <CE function>

Operation starts when “H” voltage is input into the CE pin. The IC can be put in the shutdown state by inputting “L” voltage into the CE pin. In the shutdown state, the supply current of the IC is  $0\mu\text{A}$  (TYP.), and the Pch MOS driver Tr. and Nch MOS switch Tr. for synchronous rectification turn off. The CE pin is a CMOS input and the sink current is  $0\mu\text{A}$ .

### <UVLO Circuit>

When the  $V_{IN}$  voltage becomes  $2.00\text{V}$  (TYP.) or lower, the P-ch MOS driver transistor output driver transistor is forced OFF to prevent false pulse output caused by unstable operation of the internal circuitry. When the  $V_{IN}$  pin voltage becomes  $2.10\text{V}$  (TYP.) or higher, switching operation takes place. By releasing the UVLO function, the IC performs the soft start function to initiate output startup operation. The UVLO circuit does not cause a complete shutdown of the IC, but causes pulse output to be suspended; therefore, the internal circuitry remains in operation.

### <Thermal Shutdown>

For protection against heat damage of the ICs, thermal shutdown function monitors chip temperature. The thermal shutdown circuit starts operating and the P-ch MOS driver and N-ch MOS driver transistor will be turned off when the chip’s temperature reaches  $150^\circ\text{C}$ . When the temperature drops to  $120^\circ\text{C}$  or less after shutting of the current flow, the IC performs the soft-start function to initiate output startup operation.

### <Short-circuit protection function>

The B type short-circuit protection circuit protects the device that is connected to this product and to the input/output in situations such as when the output is accidentally shorted to GND. The short-circuit protection circuit monitors the output voltage, and when the output voltage falls below the short-circuit protection threshold voltage, it turns off the Pch MOS driver Tr and latches it. Once in the latched state, operation is resumed by turning off the IC from the CE pin and then restarting, or by re-input into the  $V_{IN}$  pin.

### < $C_L$ High Speed Discharge>

The B type can quickly discharge the electric charge at the output capacitor ( $C_L$ ) when a low signal to the CE pin which enables a whole IC circuit put into OFF state, is inputted via the N-ch MOS switch transistor located between the  $V_{OUT}$  pin and the GND pin. When the IC is disabled, electric charge at the output capacitor ( $C_L$ ) is quickly discharged so that it may avoid application malfunction.

$$V = V_{OUT(T)} \times e^{-t/\tau}$$

$$t = \tau \ln (V_{OUT(T)} / V)$$

V: Output voltage after discharge

$V_{OUT(T)}$ : Output voltage

t: Discharge time

$\tau$ :  $C_L \times R_{DCHG}$

$C_L$ : Capacitance of Output capacitor

$R_{DCHG}$ :  $C_L$  auto-discharge resistance, but it depends on supply voltage.

Output Voltage Discharge characteristics  
 $R_{DCHG} = 210\Omega$  (TYP)  $C_L = 10\mu\text{F}$

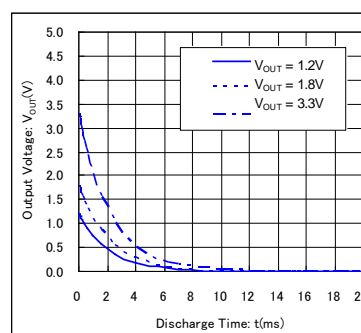

## ■ OPERATIONAL EXPLANATION (Continued)

### <Current Limit>

The current limiter circuit of the XC9260/XC9261 series monitors the current flowing through the P-channel MOS driver transistor connected to the Lx pin. When the driver current is greater than a specific level, the current limit function operates to turn off the pulses from the Lx pin at any given timing. When the over current state is eliminated, the IC resumes its normal operation.

## ■ NOTE ON USE

1. For the phenomenon of temporal and transitional voltage decrease or voltage increase, the IC may be damaged or deteriorated if IC is used beyond the absolute MAX. specifications.
2. Spike noise and ripple voltage arise in a switching regulator as with a DC/DC converter. These are greatly influenced by external component selection, such as the coil inductance, capacitance values, and board layout of external components. Once the design has been completed, verification with actual components should be done.
3. The DC/DC converter characteristics depend greatly on the externally connected components as well as on the characteristics of this IC, so refer to the specifications and standard circuit examples of each component when carefully considering which components to select. Be especially careful of the capacitor characteristics and use B characteristics (JIS standard) or X7R, X5R (EIA standard) ceramic capacitors.
4. Make sure that the PCB GND traces are as thick and wide as possible. The V<sub>SS</sub> pin or PGND pin and AGND pin fluctuation caused by high ground current at the time of switching may result in instability of the IC. Therefore, the GND traces close to the V<sub>SS</sub> pin, PGND pin and AGND pin are important.
5. Mount external components as close as possible to the IC. Keep the wiring short and thick to lower the wiring impedance.
6. A feature of HiSAT-COT control is that it controls the off time in order to control the duty, which varies due to the effects of power loss. In addition, changes in the on time due to 100% duty cycle mode are allowed. For this reason, caution must be exercised as the characteristics of the switching frequency will vary depending on the external component characteristics, board layout, input voltage, output voltage, load current and other parameters.
7. Due to propagation delay inside the product, the on time generated by the minimum on time generation circuit is not the same as the on time that is the ratio of the input voltage to the output voltage.
8. With regard to the current limiting value, the actual coil current may at times exceed the electrical characteristics due to propagation delay inside the product.
9. The CE pin is a CMOS input pin. Do not use with the pin open. If connecting to the input or ground, use the resistor not more than 1M $\Omega$  or less. To prevent malfunctioning of the device connected to this product or the input/output due to short circuiting between pins, it is recommended that a resistor be connected.
10. In the B type, if the output voltage drops below the short circuit protection threshold voltage at the end of the soft start interval, operation will stop.
11. Regarding XC9261 which has PWM/PFM auto switching control method, it works with a discontinuous conduction mode at light loads, and in this case where the voltage difference between input voltage and output voltage is low or the coil inductance is higher than the value indicated in the standard circuit example, the coil current may reverse when the load is light, and thus pulse skipping will not be possible and light load efficiency will worsen.
12. When the voltage difference between input voltage and output voltage is low, the load stability feature may deteriorate.
13. Torex places an importance on improving our products and their reliability. We request that users incorporate fail-safe designs and post-aging protection treatment when using Torex products in their systems.

## NOTE ON USE (Continued)

### 14. Instructions of pattern layouts

The operation may become unstable due to noise and/or phase lag from the output current when the wire impedance is high, please place the input capacitor( $C_{IN}$ ) and the output capacitor ( $C_L$ ) as close to the IC as possible.

- (1) In order to stabilize  $V_{IN}$  voltage level, we recommend that a by-pass capacitor ( $C_{IN}$ ) be connected as close as possible to the  $V_{IN}$  pin, PGND pin and AGND pin.
- (2) Please mount each external component as close to the IC as possible.
- (3) Wire external components as close to the IC as possible and use thick, short connecting traces to reduce the circuit impedance.
- (4) Make sure that the GND traces are as thick as possible, as variations in ground potential caused by high ground currents at the time of switching may result in instability of the IC.
- (5) This series' internal driver transistors bring on heat because of the output current and ON resistance of P-channel and N-channel MOS driver transistors. Please consider the countermeasures against heat if necessary.

<Reference pattern layout>

SOT-89-5

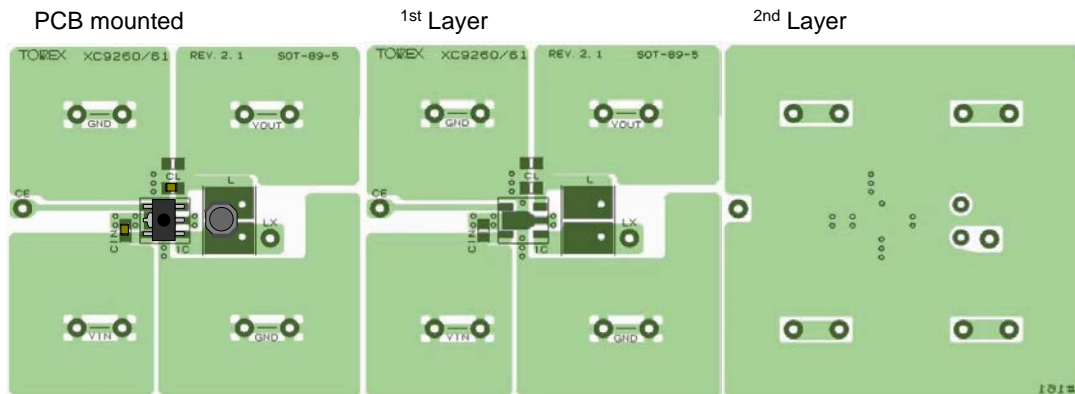

USP-6C

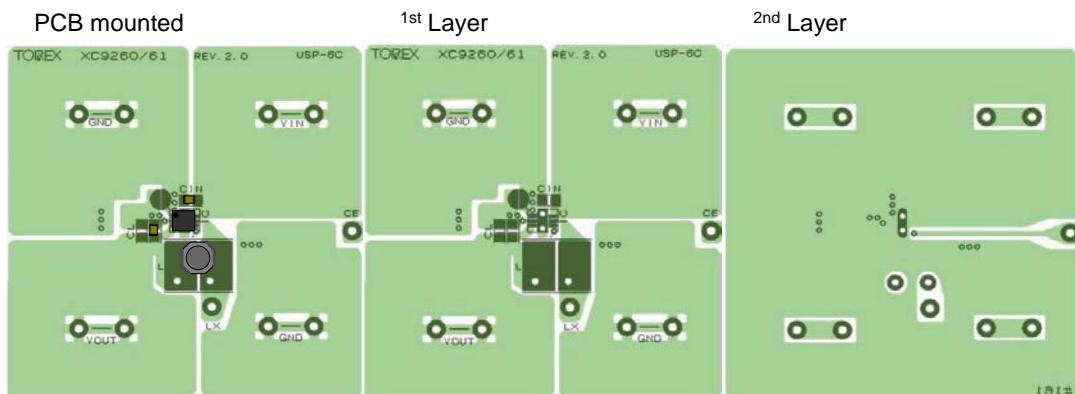

# TYPICAL PERFORMANCE CHARACTERISTICS

## (1) Efficiency vs. Output Current

XC9260A10D / XC9261A10D

L = LQM2MPN1R0MGH(1.0  $\mu$  H)  
C<sub>N</sub> = 10  $\mu$  F(GRM155R61A106M) C<sub>L</sub> = 10  $\mu$  F(GRM155R61A106M)

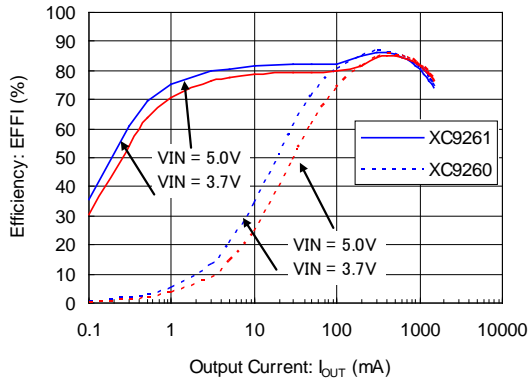

XC9260A10C / XC9261A10C

L = LTF5022T-4R7N2R0-LC(4.7  $\mu$  H)  
C<sub>N</sub> = 10  $\mu$  F(GRM155R61A106M) C<sub>L</sub> = 10  $\mu$  F(GRM155R61A106M)

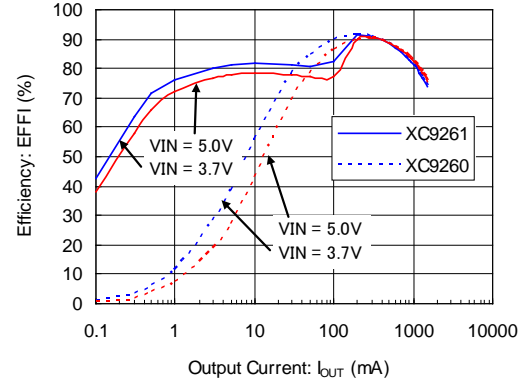

XC9260A18D / XC9261A18D

L = LQM2MPN1R0MGH(1.0  $\mu$  H)  
C<sub>N</sub> = 10  $\mu$  F(GRM155R61A106M) C<sub>L</sub> = 10  $\mu$  F(GRM155R61A106M)

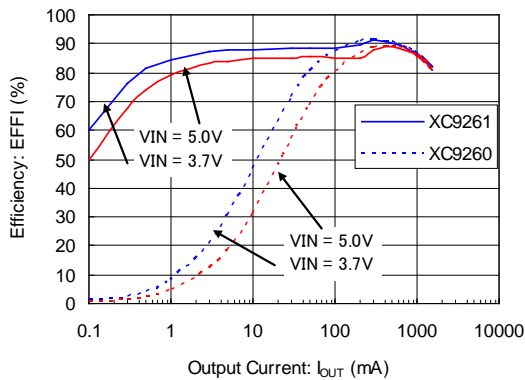

XC9260A18C / XC9261A18C

L = LTF5022T-4R7N2R0-LC(4.7  $\mu$  H)  
C<sub>N</sub> = 10  $\mu$  F(GRM155R61A106M) C<sub>L</sub> = 10  $\mu$  F(GRM155R61A106M)

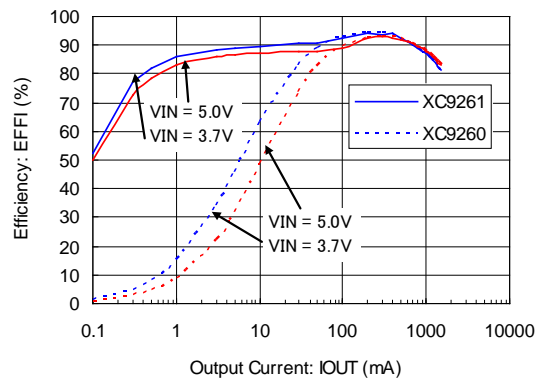

XC9260A33D / XC9261A33D

L = LQM2MPN1R0MGH(1.0  $\mu$  H)  
C<sub>N</sub> = 10  $\mu$  F(GRM155R61A106M) C<sub>L</sub> = 10  $\mu$  F(GRM155R61A106M)

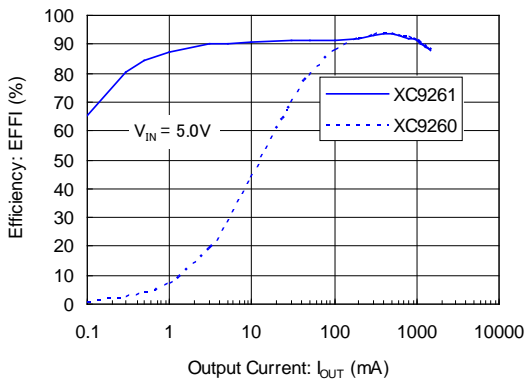

XC9260A33C / XC9261A33C

L = LTF5022T-4R7N2R0-LC(4.7  $\mu$  H)  
C<sub>N</sub> = 10  $\mu$  F(GRM155R61A106M) C<sub>L</sub> = 10  $\mu$  F(GRM155R61A106M)

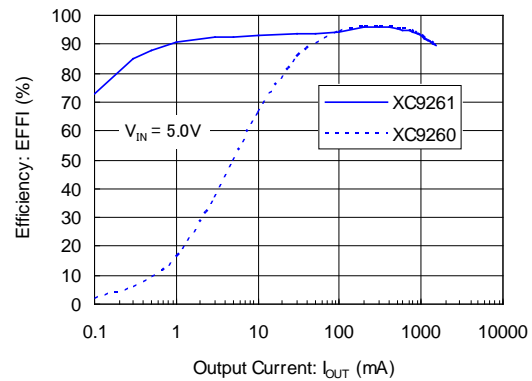

## TYPICAL PERFORMANCE CHARACTERISTICS (Continued)

### (2) Output Voltage vs. Output Current

XC9261A18D

L = LQM2MPN1R0MGH(1.0  $\mu$  H)  
 $C_{IN} = 10 \mu$  F(GRM155R61A106M)  $C_L = 10 \mu$  F(GRM155R61A106M)

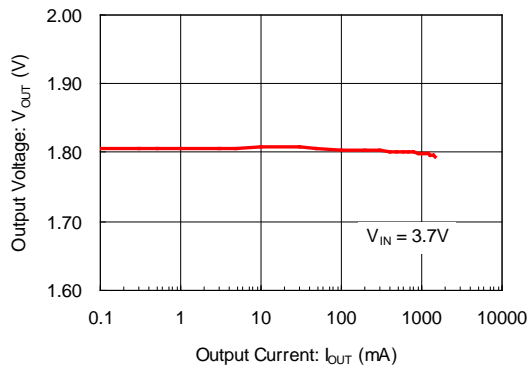

XC9261A33D

L = LQM2MPN1R0MGH(1.0  $\mu$  H)  
 $C_{IN} = 10 \mu$  F(GRM155R61A106M)  $C_L = 10 \mu$  F(GRM155R61A106M)

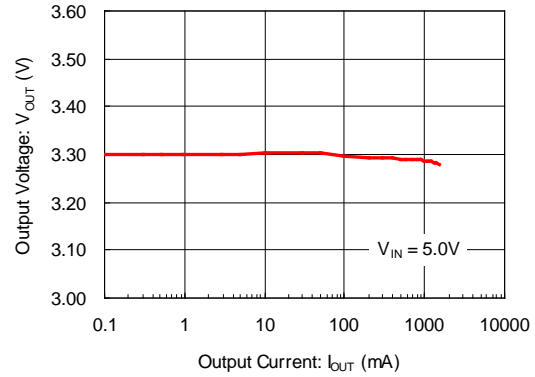

### (3) Ripple Voltage vs. Output Current

XC9260A18D / XC9261A18D

L = LQM2MPN1R0MGH(1.0  $\mu$  H)  
 $C_{IN} = 10 \mu$  F(GRM155R61A106M)  $C_L = 10 \mu$  F(GRM155R61A106M)

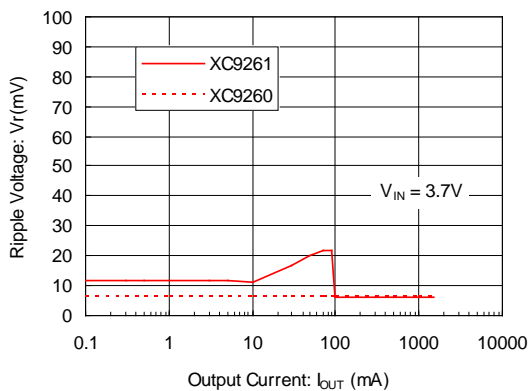

XC9260A33D / XC9261A33D

L = LQM2MPN1R0MGH(1.0  $\mu$  H)  
 $C_{IN} = 10 \mu$  F(GRM155R61A106M)  $C_L = 10 \mu$  F(GRM155R61A106M)

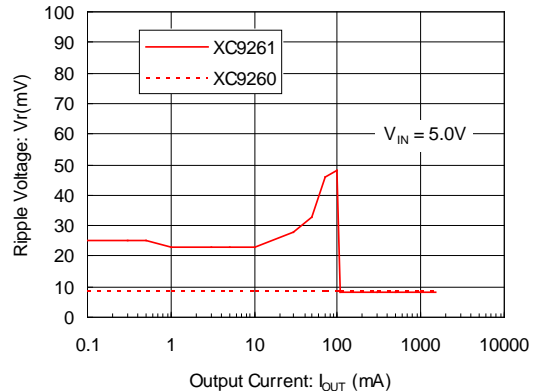

XC9260A18C / XC9261A18C

L = LTF5022T-4R7N2R0-LC(4.7  $\mu$  H)  
 $C_{IN} = 10 \mu$  F(GRM155R61A106M)  $C_L = 10 \mu$  F(GRM155R61A106M)

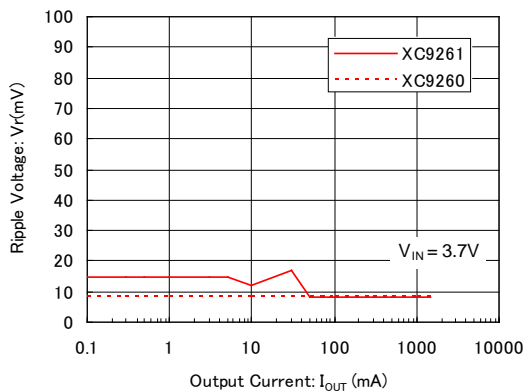

XC9260A33C / XC9261A33C

L = LTF5022T-4R7N2R0-LC(4.7  $\mu$  H)  
 $C_{IN} = 10 \mu$  F(GRM155R61A106M)  $C_L = 10 \mu$  F(GRM155R61A106M)

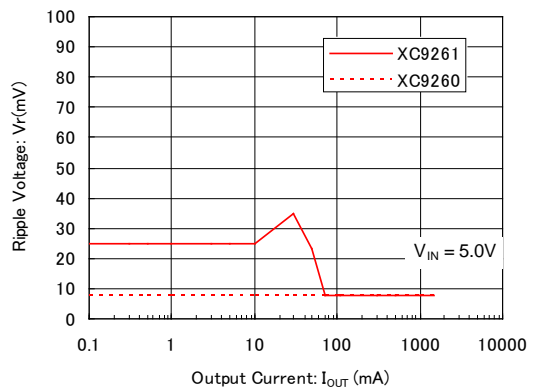



## TYPICAL PERFORMANCE CHARACTERISTICS (Continued)

(4) FB Voltage vs. Ambient Temperature

XC9261B18D

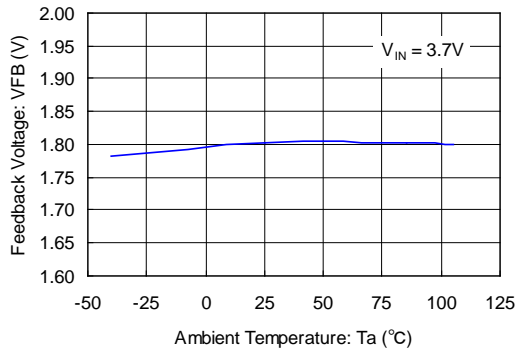

(5) UVLO Voltage vs. Ambient Temperature

XC9260A08D

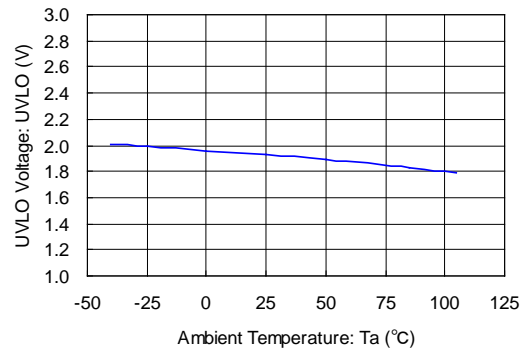

(6) Quiescent Current vs. Ambient Temperature

XC9261A08D

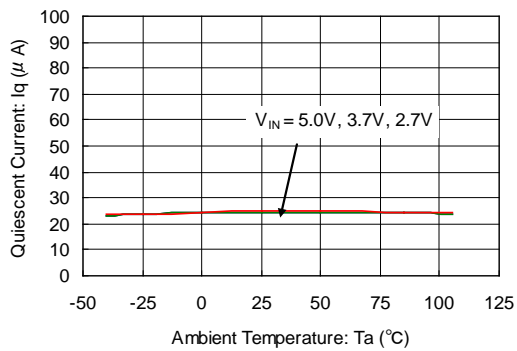

XC9261A08C

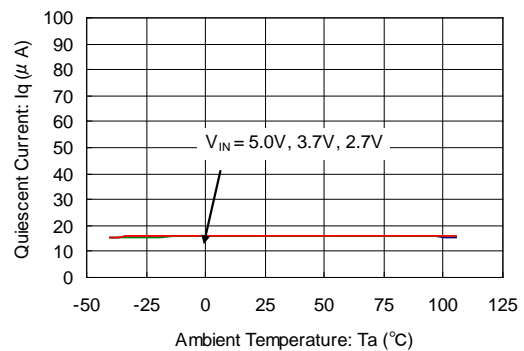

XC9260A08D

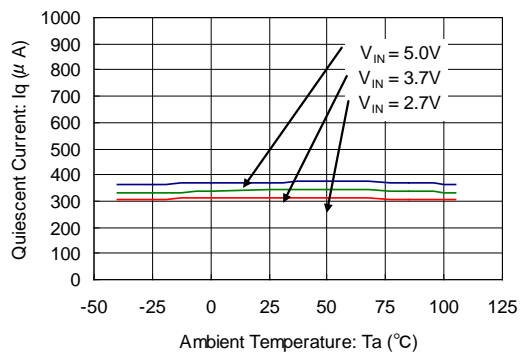

XC9260A08C

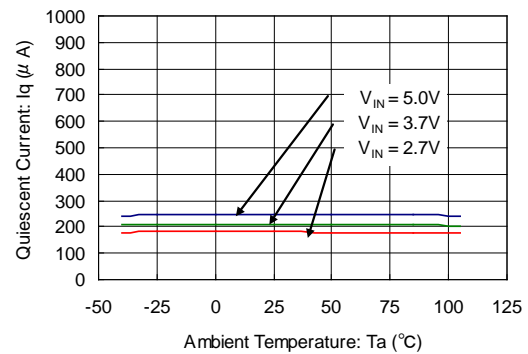

## TYPICAL PERFORMANCE CHARACTERISTICS (Continued)

(7) Stand-by Current vs. Ambient Temperature

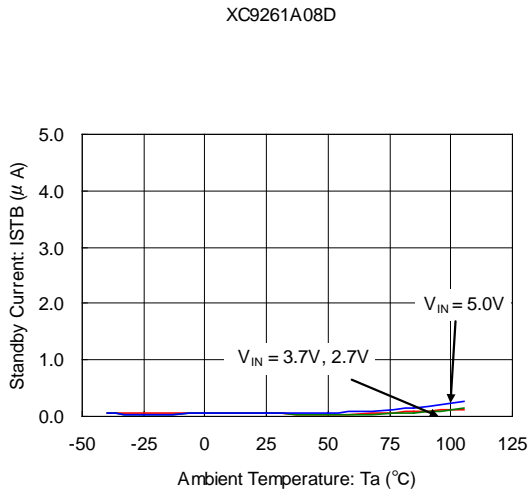

(8) Oscillation Frequency vs. Output Current

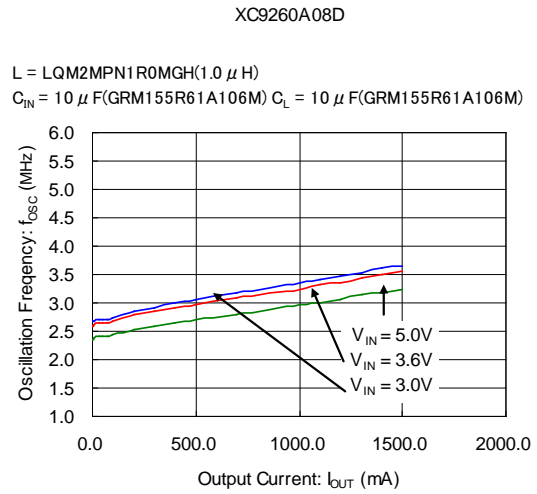

XC9260A18D

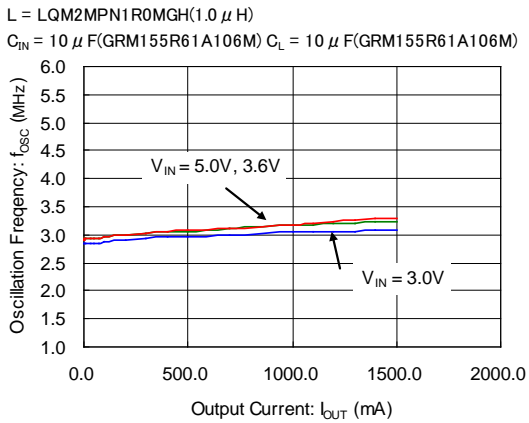

XC9260A33D

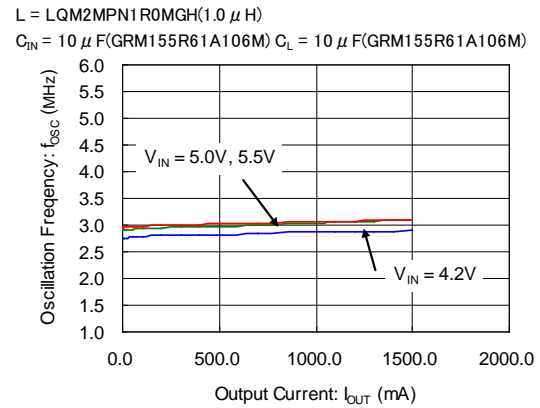

XC9260A08C

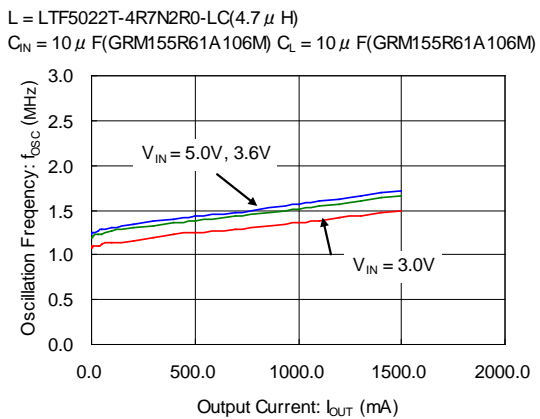

XC9260A18C

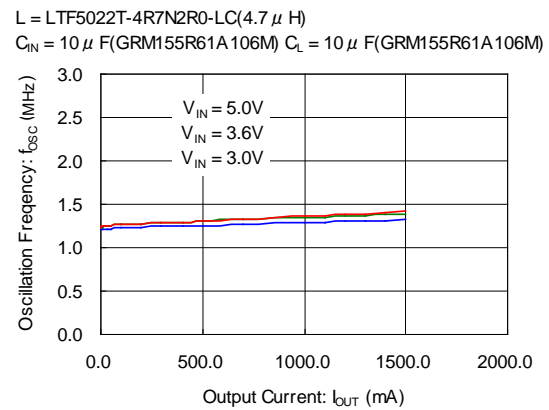

## TYPICAL PERFORMANCE CHARACTERISTICS (Continued)

(8) Oscillation Frequency vs. Output Current (Continued)

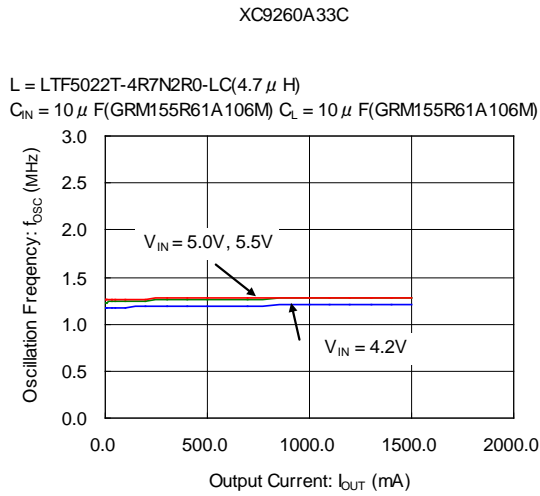

(9) Pch Driver ON Resistance vs. Ambient Temperature

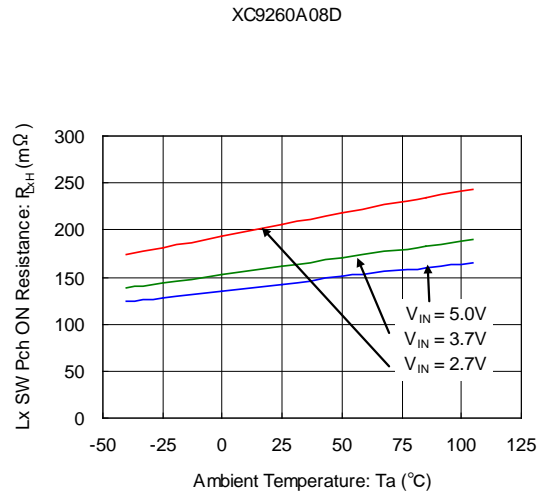

(10) Nch Driver ON Resistance vs. Ambient Temperature

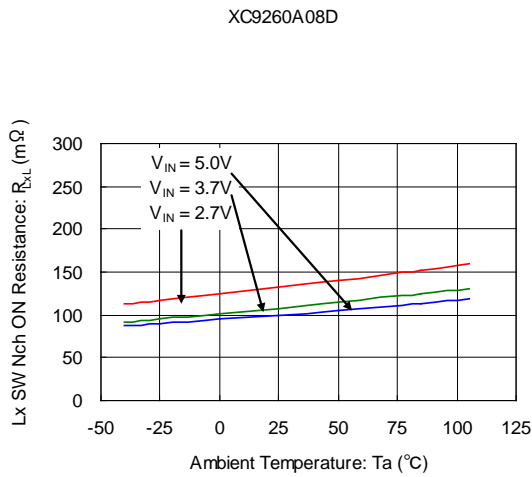

(11) LxSW "H" Leakage Current vs. Ambient Temperature

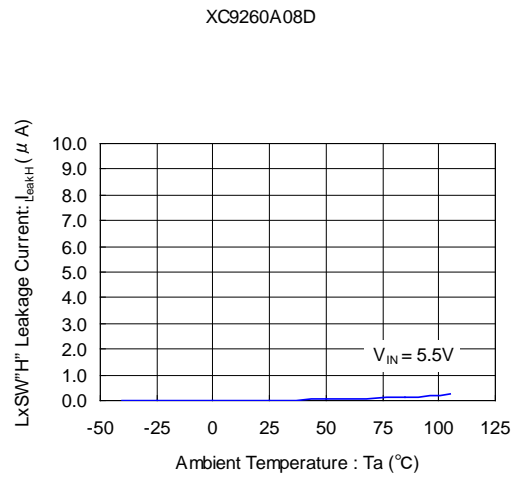

(12) LxSW "L" Leakage Current vs. Ambient Temperature

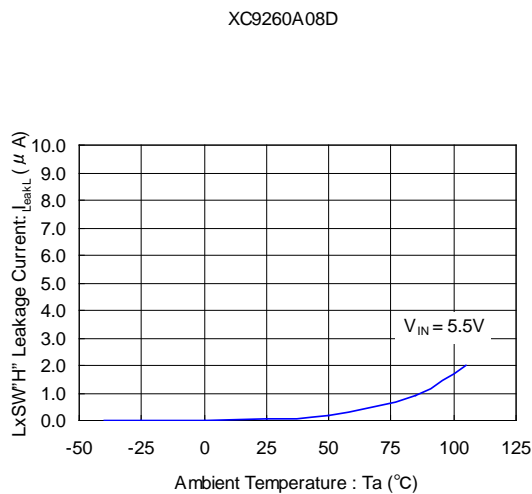

(13) CE "H" Voltage vs. Ambient Temperature

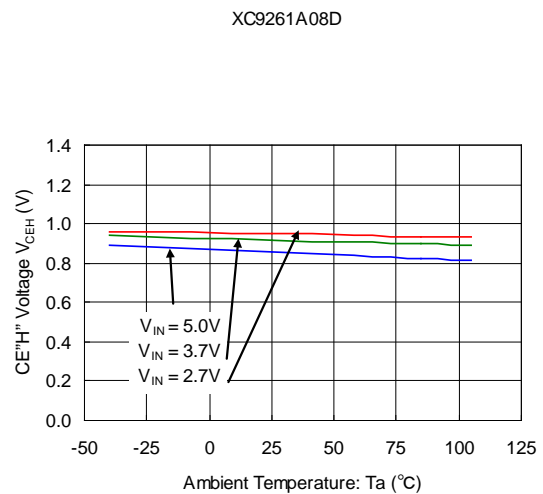

## TYPICAL PERFORMANCE CHARACTERISTICS (Continued)

(14) CE<sup>L</sup> Voltage vs. Ambient Temperature

XC9261A08D

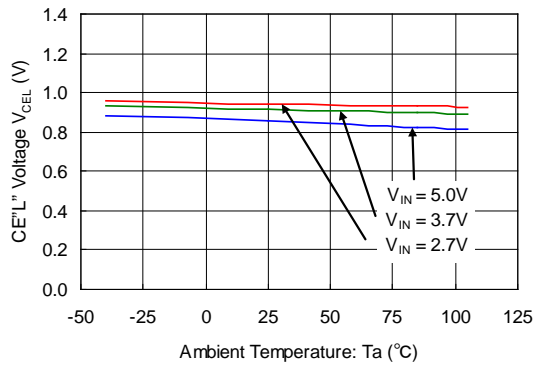

(15) Soft-Start Time vs. Ambient Temperature

XC9261B08D

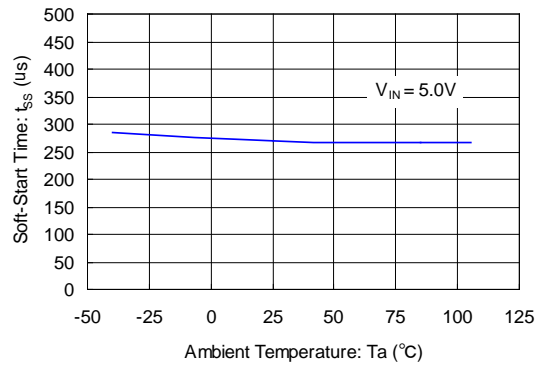

(16) Current Limit vs. Ambient Temperature

XC9261A08D

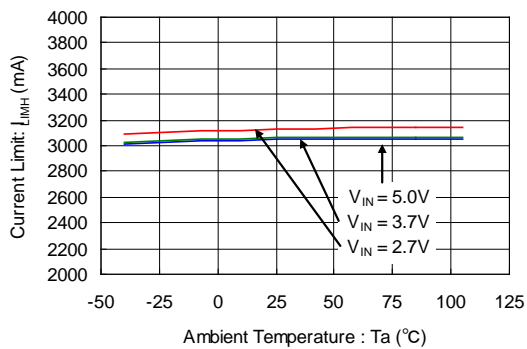

(17) CL Discharge Resistance vs. Ambient Temperature

XC9261B08D

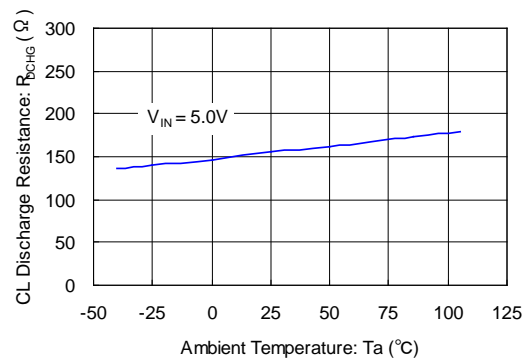

(18) Short Protection Threshold vs. Ambient Temperature

XC9261B08D

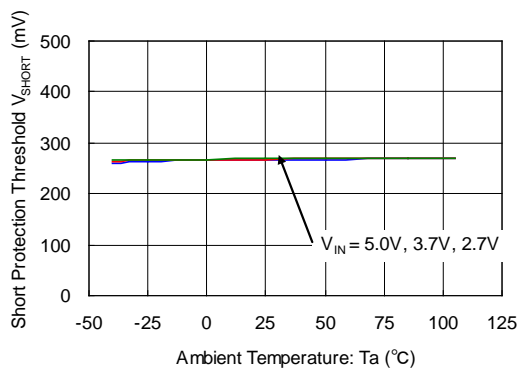

## TYPICAL PERFORMANCE CHARACTERISTICS (Continued)

### (19) Load Transient Response

XC9260A12D

$V_{IN} = 5.0V$   $V_{OUT} = 1.2V$   $f_{OSC} = 3.0MHz$   $I_{OUT} = 10mA \Rightarrow 1.0A$   
 $L = LQM2MPN1R0MGH(1.0\mu H)$   $C_{IN} = 10\mu F(GRM155R61A106M)$   
 $C_L = 10\mu F(GRM155R61A106M)$

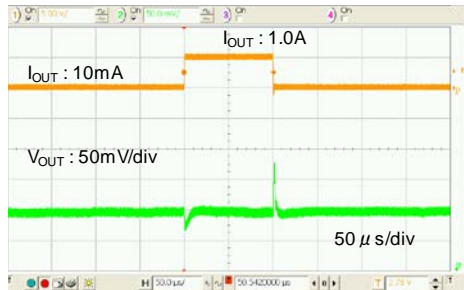

XC9261A12D

$V_{IN} = 5.0V$   $V_{OUT} = 1.2V$   $f_{OSC} = 3.0MHz$   $I_{OUT} = 10mA \Rightarrow 1.0A$   
 $L = LQM2MPN1R0MGH(1.0\mu H)$   $C_{IN} = 10\mu F(GRM155R61A106M)$   
 $C_L = 10\mu F(GRM155R61A106M)$

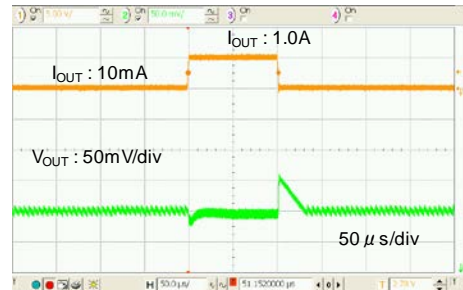

XC9260A18D

$V_{IN} = 5.0V$   $V_{OUT} = 1.8V$   $f_{OSC} = 3.0MHz$   $I_{OUT} = 10mA \Rightarrow 1.0A$   
 $L = LQM2MPN1R0MGH(1.0\mu H)$   $C_{IN} = 10\mu F(GRM155R61A106M)$   
 $C_L = 10\mu F(GRM155R61A106M)$

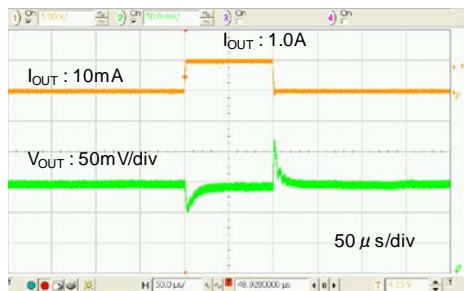

XC9261A18D

$V_{IN} = 5.0V$   $V_{OUT} = 1.8V$   $f_{OSC} = 3.0MHz$   $I_{OUT} = 10mA \Rightarrow 1.0A$   
 $L = LQM2MPN1R0MGH(1.0\mu H)$   $C_{IN} = 10\mu F(GRM155R61A106M)$   
 $C_L = 10\mu F(GRM155R61A106M)$

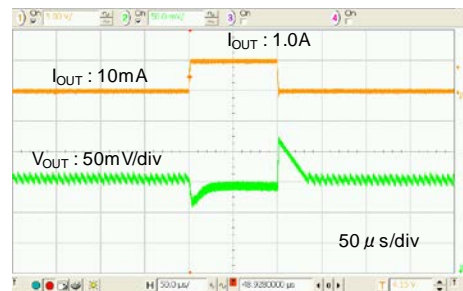

XC9260A33D

$V_{IN} = 5.0V$   $V_{OUT} = 3.3V$   $f_{OSC} = 3.0MHz$   $I_{OUT} = 10mA \Rightarrow 1.0A$   
 $L = LQM2MPN1R0MGH(1.0\mu H)$   $C_{IN} = 10\mu F(GRM155R61A106M)$   
 $C_L = 10\mu F(GRM155R61A106M)$

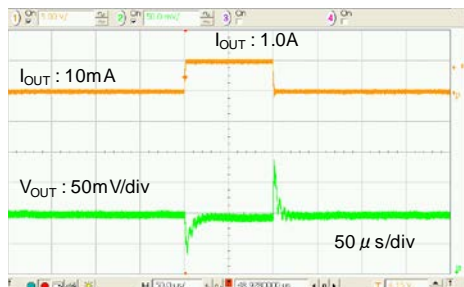

XC9261A33D

$V_{IN} = 5.0V$   $V_{OUT} = 3.3V$   $f_{OSC} = 3.0MHz$   $I_{OUT} = 10mA \Rightarrow 1.0A$   
 $L = LQM2MPN1R0MGH(1.0\mu H)$   $C_{IN} = 10\mu F(GRM155R61A106M)$   
 $C_L = 10\mu F(GRM155R61A106M)$

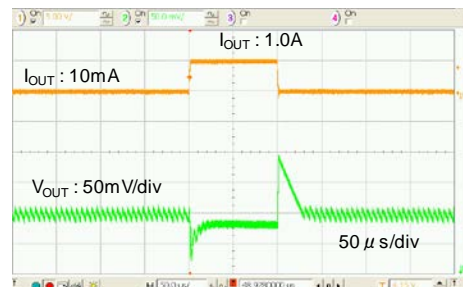

## TYPICAL PERFORMANCE CHARACTERISTICS (Continued)

### (19) Load Transient Response (Continued)

XC9260A12C

$V_{IN} = 5.0V$   $V_{OUT} = 1.2V$   $f_{OSC} = 1.2MHz$   $I_{OUT} = 10mA \Rightarrow 1.0A$   
 $L = LTF5022T-4R7N2R0-LC(4.7\mu H)$   $C_{IN} = 10\mu F(GRM155R61A106M)$   
 $C_L = 10\mu F(GRM155R61A106M)$

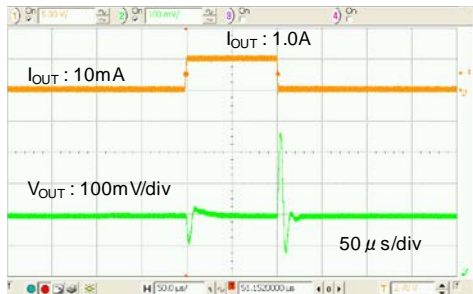

XC9261A12C

$V_{IN} = 5.0V$   $V_{OUT} = 1.2V$   $f_{OSC} = 1.2MHz$   $I_{OUT} = 10mA \Rightarrow 1.0A$   
 $L = LTF5022T-4R7N2R0-LC(4.7\mu H)$   $C_{IN} = 10\mu F(GRM155R61A106M)$   
 $C_L = 10\mu F(GRM155R61A106M)$

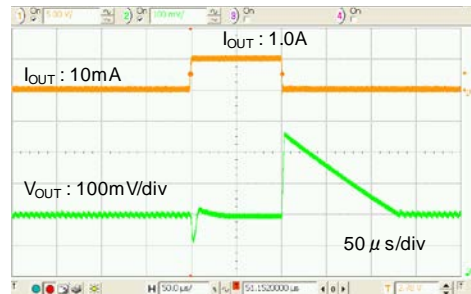

XC9260A18C

$V_{IN} = 5.0V$   $V_{OUT} = 1.8V$   $f_{OSC} = 1.2MHz$   $I_{OUT} = 10mA \Rightarrow 1.0A$   
 $L = LTF5022T-4R7N2R0-LC(4.7\mu H)$   $C_{IN} = 10\mu F(GRM155R61A106M)$   
 $C_L = 10\mu F(GRM155R61A106M)$

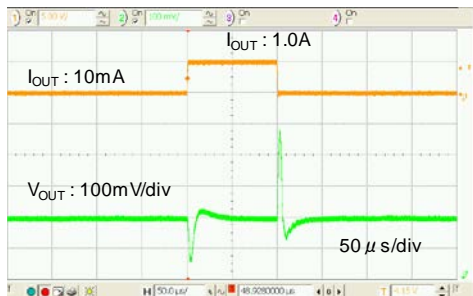

XC9261A18C

$V_{IN} = 5.0V$   $V_{OUT} = 1.8V$   $f_{OSC} = 1.2MHz$   $I_{OUT} = 10mA \Rightarrow 1.0A$   
 $L = LTF5022T-4R7N2R0-LC(4.7\mu H)$   $C_{IN} = 10\mu F(GRM155R61A106M)$   
 $C_L = 10\mu F(GRM155R61A106M)$

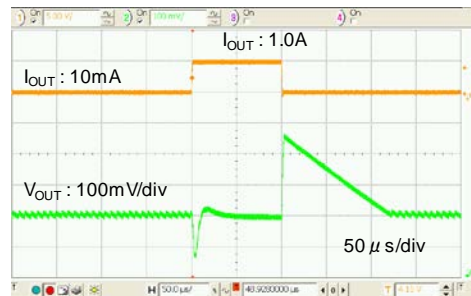

XC9260A33C

$V_{IN} = 5.0V$   $V_{OUT} = 3.3V$   $f_{OSC} = 1.2MHz$   $I_{OUT} = 10mA \Rightarrow 1.0A$   
 $L = LTF5022T-4R7N2R0-LC(4.7\mu H)$   $C_{IN} = 10\mu F(GRM155R61A106M)$   
 $C_L = 10\mu F(GRM155R61A106M)$

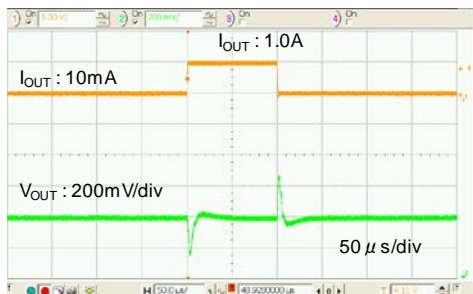

XC9261A33C

$V_{IN} = 5.0V$   $V_{OUT} = 3.3V$   $f_{OSC} = 1.2MHz$   $I_{OUT} = 10mA \Rightarrow 1.0A$   
 $L = LTF5022T-4R7N2R0-LC(4.7\mu H)$   $C_{IN} = 10\mu F(GRM155R61A106M)$   
 $C_L = 10\mu F(GRM155R61A106M)$

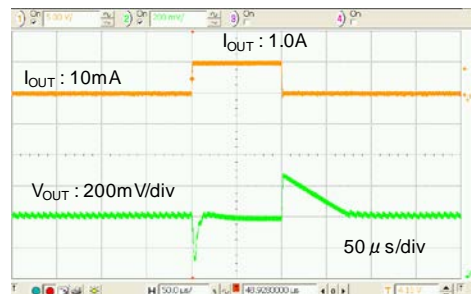

## ■ PACKAGING INFORMATION

For the latest package information go to, [www.torexsemi.com/technical-support/packages](http://www.torexsemi.com/technical-support/packages)

PACKAGE	OUTLIN / LAND PATTERN	THERMAL CHARACTERISTICS	
SOT-89-5	<a href="#">SOT-89-5 PKG</a>	Standard Board	<a href="#">SOT-89-5 Power Dissipation</a>
		JESD51-7 Board	
USP-6C	<a href="#">USP-6C PKG</a>	Standard Board	<a href="#">USP-6C Power Dissipation</a>
		JESD51-7 Board	

## MARKING RULE

SOT89-5

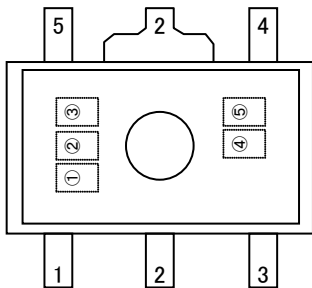

USP-6C

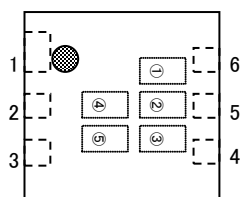

① represents products series

MARK	PRODUCT SERIES
A	XC9260A****-G, XC9261A****-G
B	XC9260B****-G, XC9261B****-G

② represents integer and oscillation frequency of the output voltage

V <sub>OUT</sub> (V)	MARK			
	XC9260 Series		XC9261 Series	
	f <sub>osc</sub> =1.2MHz	f <sub>osc</sub> =3.0MHz	f <sub>osc</sub> =1.2MHz	f <sub>osc</sub> =3.0MHz
0.x	A	E	N	U
1.x	B	F	P	V
2.x	C	L	R	X
3.x	D	M	T	Y

③ represents decimal number of the output voltage

V <sub>OUT</sub> (V)	MARK	V <sub>OUT</sub> (V)	MARK
X.00	0	X.05	A
X.10	1	X.15	B
X.20	2	X.25	C
X.30	3	X.35	D
X.40	4	X.45	E
X.50	5	X.55	F
X.60	6	X.65	H
X.70	7	X.75	K
X.80	8	X.85	L
X.90	9	X.95	M

④⑤ represents production lot number

01~09, 0A~0Z, 11~9Z, A1~A9, AA~AZ, B1~ZZ in order.

(G, I, J, O, Q, W excluded)

\* No character inversion used.



1. The product and product specifications contained herein are subject to change without notice to improve performance characteristics. Consult us, or our representatives before use, to confirm that the information in this datasheet is up to date.
2. The information in this datasheet is intended to illustrate the operation and characteristics of our products. We neither make warranties or representations with respect to the accuracy or completeness of the information contained in this datasheet nor grant any license to any intellectual property rights of ours or any third party concerning with the information in this datasheet.
3. Applicable export control laws and regulations should be complied and the procedures required by such laws and regulations should also be followed, when the product or any information contained in this datasheet is exported.
4. The product is neither intended nor warranted for use in equipment of systems which require extremely high levels of quality and/or reliability and/or a malfunction or failure which may cause loss of human life, bodily injury, serious property damage including but not limited to devices or equipment used in 1) nuclear facilities, 2) aerospace industry, 3) medical facilities, 4) automobile industry and other transportation industry and 5) safety devices and safety equipment to control combustions and explosions. Do not use the product for the above use unless agreed by us in writing in advance.
5. Although we make continuous efforts to improve the quality and reliability of our products; nevertheless Semiconductors are likely to fail with a certain probability. So in order to prevent personal injury and/or property damage resulting from such failure, customers are required to incorporate adequate safety measures in their designs, such as system fail safes, redundancy and fire prevention features.
6. Our products are not designed to be Radiation-resistant.
7. Please use the product listed in this datasheet within the specified ranges.
8. We assume no responsibility for damage or loss due to abnormal use.
9. All rights reserved. No part of this datasheet may be copied or reproduced unless agreed by Torex Semiconductor Ltd in writing in advance.

TOREX SEMICONDUCTOR LTD.

单击下面可查看定价，库存，交付和生命周期等信息

[>>Torex Semiconductor\(特瑞仕\)](#)