

0.6 μ A Ultra Low Power Consumption Small Voltage Regulator (C_L Capacitor-Less)

■ GENERAL DESCRIPTION

The XC6504 series is a highly accurate CMOS voltage regulator that achieves very low supply current operation of 0.6 μ A. Even output current is 1 μ A (when light load), the XC6504 can provide high accurate outputs, which is ideally suited for the applications to draw less output current. The usage of super small package USPN-4B02 (0.75 x 0.95mm) and the advantage of capacitor-less stable operation can contribute the board space saving outstandingly. The IC consists of a reference voltage source, an error amplifier, a driver transistor, over-current protection circuit, and a phase compensation circuit.

The device is compatible with a low ESR ceramic output capacitor C_L . Moreover, the device can provide stable output even without a C_L output capacitor because of the excellent internal phase compensation.

Output voltage is fixed internally by laser trimming technology and can be selectable in 0.1V increments within the range of 1.1V to 5.0V. The CE function enables the device to be put into standby mode by inputting a low level signal to the CE pin thereby reducing current consumption to less than 0.1 μ A. In the standby mode, if a C_L output capacitor is used, the electric charge stored at C_L can be discharged via the internal switch and as a result, the V_{OUT} pin quickly returns to the V_{SS} level.

■ APPLICATIONS

- Mobile devices / terminals
- Wireless LAN
- Modules (wireless, cameras, etc.)

■ FEATURES

| | | |
|-------------------------------|---|---|
| Supply Current | : | 0.6 μ A |
| Input Voltage Range | : | 1.4V~6.0V |
| Output Voltage Range | : | 1.1V~5.0V (0.1V increments) |
| Output Accuracy | : | $\pm 0.02V @ V_{OUT} < 2.0V$ $\pm 1% @ V_{OUT} \geq 2.0V$ |
| Temperature Stability | : | $\pm 50\text{ppm}/^\circ\text{C}$ |
| Maximum Output Current | : | 150mA |
| Low On Resistance | : | $3.3\Omega @ V_{OUT}=3.0V$ |
| Standby Current | : | 0.01 μ A |
| Protection Current | : | Current Limiter Shot Circuit Protection |
| CE Function | : | C_L Auto Discharge ON/OFF Logic=Enable High |
| Output Capacitor | : | Low ESR Ceramic Capacitor (C_L Capacitor-Less Compatible) |
| Operating Ambient Temperature | : | $-40^\circ\text{C} \sim +85^\circ\text{C}$ |
| Packages | : | USPN-4B02 SSOT-24 SOT-25 USPQ-4B04 |
| Environmentally Friendly | : | EU RoHS Compliant, Pb Free |

■ TYPICAL APPLICATION CIRCUIT

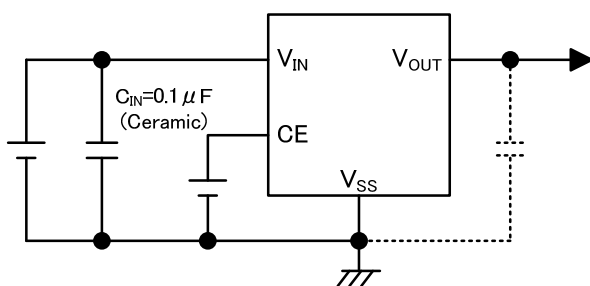

■ TYPICAL PERFORMANCE CHARACTERISTICS

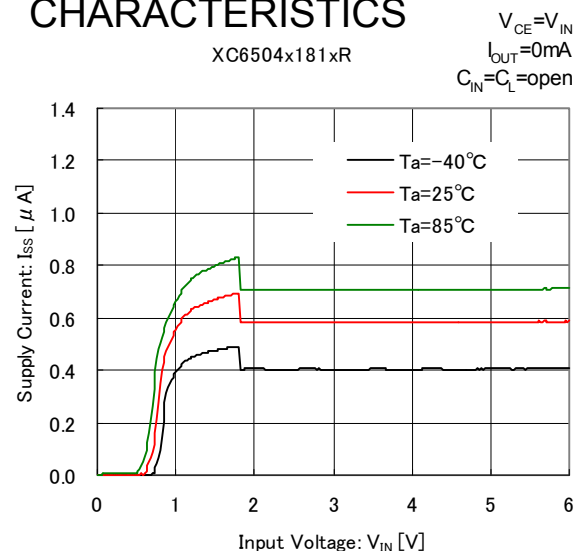

■ BLOCK DIAGRAM

XC6504 Series, Type A



* Diodes inside the circuits are ESD protection diodes and parasitic diodes.

■ PRODUCT CLASSIFICATION

● Ordering Information

XC6504①②③④⑤⑥-⑦

| DESIGNATOR | ITEM | SYMBOL | DESCRIPTION |
|---------------------|-------------------------|--------|---|
| ① | Type | A | Refer to Selection Guide |
| ②③ | Output Voltage | 11~50 | e.g. 1.8V → ②=1, ③=8 |
| ④ | Output Voltage Accuracy | 1 | $\pm 0.02V$ ($V_{OUT} < 2.0V$), $\pm 1\%$ ($V_{OUT} \geq 2.0V$) |
| ⑤⑥-⑦ ^(*) | Packages (Order Unit) | 7R-G | USPN-4B02 (5,000pcs/Reel) |
| | | NR-G | SSOT-24 (3,000pcs/Reel) |
| | | MR-G | SOT-25 (3,000pcs/Reel) |
| | | 9R-G | USPQ-4B04 (3,000pcs/Reel) |

^(*) The "-G" suffix denotes Halogen and Antimony free as well as being fully EU RoHS compliant.

● Selection Guide

| TYPE | CURRENT LIMITTER | CE PULL-DOWN RESISTOR | C _L AUTO-DISCHARGE |
|------|------------------|-----------------------|-------------------------------|
| A | Yes | No | Yes |

■ PIN CONFIGURATION

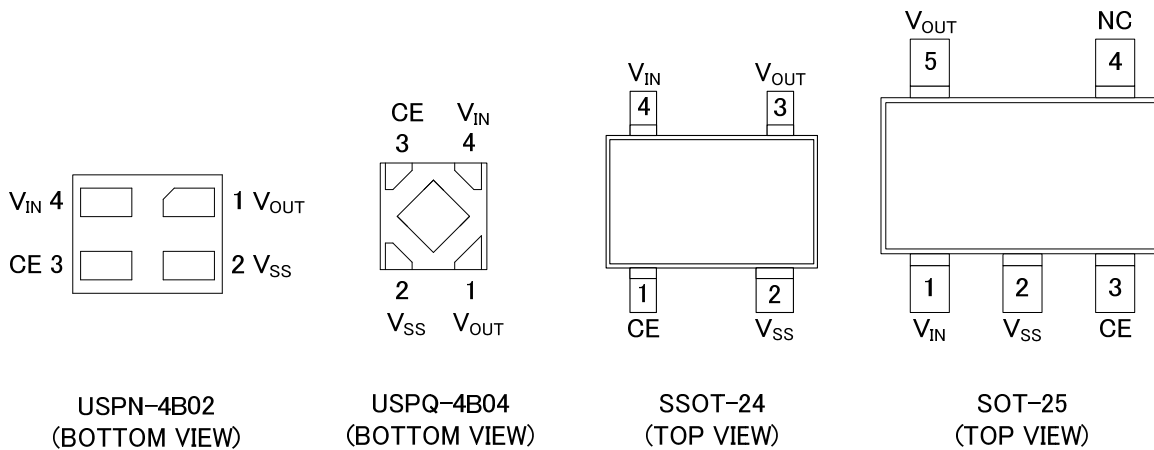

*The dissipation pad for the USPQ-4B04 package should be solder-plated in reference mount pattern and metal masking so as to enhance mounting strength and heat release.
If the pad needs to be connected to other pins, it should be connected to the V_{SS} (No. 2) pin.

■ PIN ASSIGNMENT

| PIN NUMBER | | | | PIN NAME | FUNCTIONS |
|------------|-----------|---------|--------|------------------|--------------------|
| USPN-4B02 | USPQ-4B04 | SSOT-24 | SOT-25 | | |
| 1 | 1 | 3 | 5 | V _{OUT} | Output |
| 2 | 2 | 2 | 2 | V _{SS} | Ground |
| 3 | 3 | 1 | 3 | CE | ON/OFF Control |
| 4 | 4 | 4 | 1 | V _{IN} | Power Supply Input |
| - | - | - | 4 | NC | No Connection |

■ FUNCTION CHART

| PIN NAME | SIGNAL | STATUS |
|----------|--------|----------|
| CE | L | Stand-by |
| | H | Active |
| | OPEN | Unstable |

* Please avoid the state of OPEN, and connect CE pin to any arbitrary voltage.

ABSOLUTE MAXIMUM RATINGS

| Ta=25°C | | | | |
|--|-----------|------------------|---|-------|
| PARAMETER | | SYMBOL | RATINGS | UNITS |
| Input Voltage | | V _{IN} | -0.3~+6.5 | V |
| Output Current | | I _{OUT} | 470 ^{(*)1} | mA |
| Output Voltage | | V _{OUT} | -0.3~V _{IN} +0.3 or +6.5 ^{(*)2} | V |
| CE Input Voltage | | V _{CE} | -0.3~+6.5 | V |
| Power Dissipation | USPQ-4B04 | Pd | 100 | mW |
| | | | 550 (40mm x 40mm Standard board) ^{(*)3} | |
| | USPN-4B02 | | 100 | |
| | | | 550 (40mm x 40mm Standard board) ^{(*)3} | |
| | SSOT-24 | | 150 | |
| | | | 500 (40mm x 40mm Standard board) ^{(*)3} | |
| | SOT-25 | | 250 | |
| 600 (40mm x 40mm Standard board) ^{(*)3} | | | | |
| Operating Ambient Temperature | | Topr | -40~+85 | °C |
| Storage Temperature | | Tstg | -55~+125 | °C |

All voltages are described based on the V_{SS}.

^{(*)1} Please use within the range of $I_{OUT} \leq Pd / (V_{IN} - V_{OUT})$

^{(*)2} The maximum rating corresponds to the lowest value between V_{IN}+0.3 or +6.5.

^{(*)3} The power dissipation figure shown is PCB mounted and is for reference only

Please see the power dissipation page for the mounting condition.

ELECTRICAL CHARACTERISTICS

Ta=25°C

| PARAMETER | SYMBOL | CONDITIONS | MIN. | TYP. | MAX. | UNITS | CIRCUIT | |
|--|---|--|---|-------------------------------------|--------|--------|---------|---|
| Input Voltage | V _{IN} | I _{OUT} =1 μA | 1.4 | - | 6.0 | V | ① | |
| Output Voltage | V _{OUT(E)} ^(*) | V _{OUT(T)} <2.0V | -0.02 | V _{OUT(T)} ^(**) | +0.02 | V | ① | |
| | | V _{OUT(T)} ≥2.0V | × 0.99 | | × 1.01 | | | |
| Maximum Output Current | I _{OUTMAX} | | 150 | - | - | mA | ① | |
| Load Regulation | ΔV _{OUT} | 1 μA ≤ I _{OUT} ≤ 1mA | - | 3 | 16 | mV | ① | |
| | | 1mA ≤ I _{OUT} ≤ 150mA | - | 17 | 50 | | | |
| Dropout Voltage | V _{dif1} ^(***) | I _{OUT} =50mA | - | E-1 ^(****) | | V | ① | |
| | V _{dif2} ^(***) | I _{OUT} =150mA | - | E-2 ^(****) | | | | |
| Supply Current | I _{SS} | I _{OUT} =0mA | V _{OUT(T)} <1.9V | - | 0.60 | 1.27 | μA | ② |
| | | | 1.9V ≤ V _{OUT(T)} < 4.0V | - | 0.65 | 1.50 | | |
| | | | V _{OUT(T)} ≥ 4.0V | - | 0.80 | 1.80 | | |
| Stand-by Current | I _{STB} | V _{IN} =6.0V, V _{CE} =V _{SS} | - | 0.01 | 0.10 | μA | ② | |
| Line Regulation | ΔV _{OUT} / (ΔV _{IN} · V _{OUT}) | I _{OUT} =1 μA | V _{OUT(T)} +0.5V ≤ V _{IN} ≤ 6.0V | - | 0.01 | 0.13 | % / V | ① |
| | | I _{OUT} =1mA | V _{OUT(T)} <1.2V, 1.7V ≤ V _{IN} ≤ 6.0V | - | 0.01 | 0.19 | | |
| | | | V _{OUT(T)} ≥ 1.2V, V _{OUT(T)} +0.5V ≤ V _{IN} ≤ 6.0V | - | | | | |
| Output Voltage Temperature Characteristics | ΔV _{OUT} / (ΔT _{opr} · V _{OUT}) | I _{OUT} =10mA, -40°C ≤ T _{opr} ≤ 85°C | - | ±50 | - | ppm/°C | ① | |
| Current Limit | I _{LIM} | V _{OUT} =V _{OUT(E)} × 0.95 | 150 | 270 | - | mA | ① | |
| Short-Circuit Current | I _{SHORT} | V _{OUT} =V _{SS} | - | 80 | - | mA | ① | |
| C _L Auto-Discharge Resistance | R _{DCHG} | V _{CE} =V _{SS} , V _{OUT} =V _{OUT(T)} | 280 | 450 | 640 | Ω | ① | |
| CE "H" Level Voltage | V _{CEH} | | 0.91 | - | 6.00 | V | ③ | |
| CE "L" Level Voltage | V _{CEL} | | V _{SS} | - | 0.38 | V | ③ | |
| CE "H" Level Current | I _{CEH} | V _{IN} = 6.0V | -0.1 | - | 0.1 | μA | ③ | |
| CE "L" Level Current | I _{CEL} | V _{IN} =6.0V, V _{CE} =V _{SS} | -0.1 | - | 0.1 | μA | ③ | |

NOTE:

Unless otherwise stated, V_{CE}=V_{IN}, I_{OUT}=1mA, C_{IN}=C_L=open, V_{IN} is below:

$$V_{OUT(T)} < 2.5V : V_{IN} = 3.5V$$

$$V_{OUT(T)} \geq 2.5V : V_{IN} = V_{OUT(T)} + 1.0V$$

(*) V_{OUT(E)} is Effective output voltage

(**) V_{OUT(T)} is Nominal output voltage

(***) V_{dif}={V_{IN1} - V_{OUT1}}

V_{IN1} is the input voltage when V_{OUT1} appears at the V_{OUT} pin while input voltage is gradually decreased.

V_{OUT1} is the voltage equal to 98% of the normal output voltage when amply stabilized V_{OUT(T)}+1.0V is input at the V_{IN} pin.

(****) E-1 / E-2: DROPOUT VOLTAGE (Refer to the Voltage Chart)

ELECTRICAL CHARACTERISTICS (Continued)

Voltage Chart

Ta=25°C

| NOMINAL OUTPUT VOLTAGE | - | | E-1 | | E-2 | |
|------------------------------|-----------------------|--------|------------------------|------|-------------------|------|
| | OUTPUT VOLTAGE (V) | | DROPOUT VOLTAGE (V) | | | |
| V _{OUT(T)} (V) | V _{OUT(E)} | | V _{dif1} | | V _{dif2} | |
| | MIN. | MAX. | TYP. | MAX. | TYP. | MAX. |
| 1.1 | 1.0800 | 1.1200 | 0.96 | 1.35 | 1.51 | 2.05 |
| 1.2 | 1.1800 | 1.2200 | 0.87 | 1.23 | 1.41 | 1.93 |
| 1.3 | 1.2800 | 1.3200 | 0.77 | 1.12 | 1.33 | 1.83 |
| 1.4 | 1.3800 | 1.4200 | 0.69 | 1.01 | 1.24 | 1.72 |
| 1.5 | 1.4800 | 1.5200 | 0.62 | 0.91 | 1.17 | 1.63 |
| 1.6 | 1.5800 | 1.6200 | 0.56 | 0.84 | 1.10 | 1.54 |
| 1.7 | 1.6800 | 1.7200 | 0.51 | 0.77 | 1.04 | 1.47 |
| 1.8 | 1.7800 | 1.8200 | 0.47 | 0.72 | 0.99 | 1.40 |
| 1.9 | 1.8800 | 1.9200 | 0.42 | 0.64 | 0.92 | 1.29 |
| 2.0 | 1.9800 | 2.0200 | 0.37 | 0.58 | 0.86 | 1.20 |
| 2.1 | 2.0790 | 2.1210 | | | | |
| 2.2 | 2.1780 | 2.2220 | 0.31 | 0.47 | 0.75 | 1.05 |
| 2.3 | 2.2770 | 2.3230 | | | | |
| 2.4 | 2.3760 | 2.4240 | 0.26 | 0.40 | 0.67 | 0.92 |
| 2.5 | 2.4750 | 2.5250 | | | | |
| 2.6 | 2.5740 | 2.6260 | 0.23 | 0.34 | 0.60 | 0.82 |
| 2.7 | 2.6730 | 2.7270 | | | | |
| 2.8 | 2.7720 | 2.8280 | 0.20 | 0.30 | 0.54 | 0.74 |
| 2.9 | 2.8710 | 2.9290 | | | | |
| 3.0 | 2.9700 | 3.0300 | 0.17 | 0.26 | 0.50 | 0.67 |
| 3.1 | 3.0690 | 3.1310 | | | | |
| 3.2 | 3.1680 | 3.2320 | | | | |
| 3.3 | 3.2670 | 3.3330 | | | | |
| 3.4 | 3.3660 | 3.4340 | | | | |
| 3.5 | 3.4650 | 3.5350 | 0.15 | 0.22 | 0.43 | 0.59 |
| 3.6 | 3.5640 | 3.6360 | | | | |
| 3.7 | 3.6630 | 3.7370 | | | | |
| 3.8 | 3.7620 | 3.8380 | | | | |
| 3.9 | 3.8610 | 3.9390 | | | | |
| 4.0 | 3.9600 | 4.0400 | 0.13 | 0.19 | 0.38 | 0.51 |
| 4.1 | 4.0590 | 4.1410 | | | | |
| 4.2 | 4.1580 | 4.2420 | | | | |
| 4.3 | 4.2570 | 4.3430 | | | | |
| 4.4 | 4.3560 | 4.4440 | | | | |
| 4.5 | 4.4550 | 4.5450 | 0.11 | 0.17 | 0.35 | 0.47 |
| 4.6 | 4.5540 | 4.6460 | | | | |
| 4.7 | 4.6530 | 4.7470 | | | | |
| 4.8 | 4.7520 | 4.8480 | | | | |
| 4.9 | 4.8510 | 4.9490 | | | | |
| 5.0 | 4.9500 | 5.0500 | 0.10 | 0.16 | 0.32 | 0.43 |

■ TEST CIRCUITS

Circuit ①

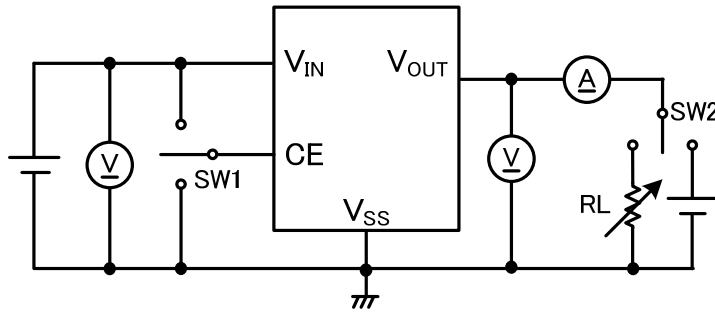

Circuit ②

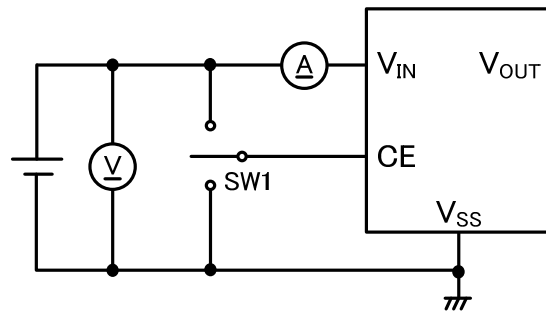

Circuit ③

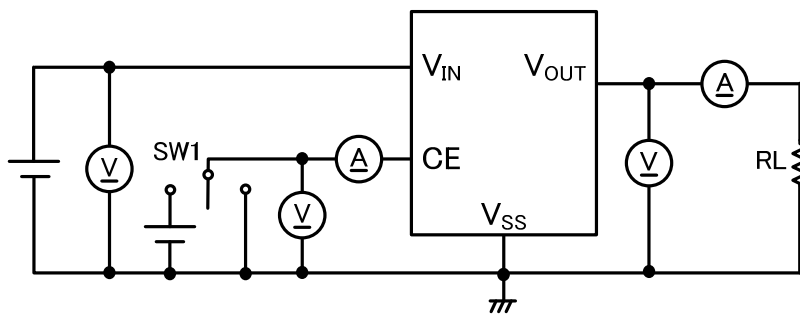

OPERATIONAL EXPLANATION

The voltage divided by resistors R1 & R2 is compared with the internal reference voltage by the error amplifier. The V_{OUT} pin is then driven by the subsequent output signal. The output voltage at the V_{OUT} pin is controlled and stabilized by a system of negative feedback.

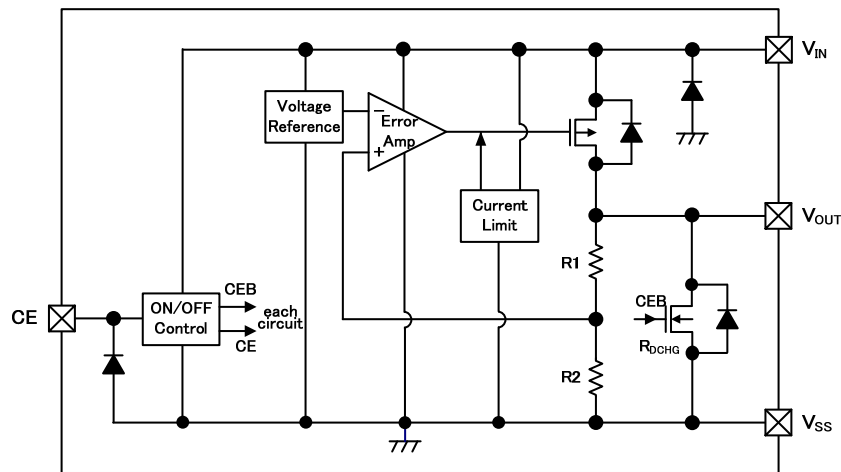

XC6504 Series, Type A

<Current Limiter, Short-Circuit Protection>

The XC6504 series includes a combination of a fixed current limiter circuit & a foldback circuit, which aid the operations of the current limiter and circuit protection. When the load current reaches the current limit level, the fixed current limiter circuit operates and output voltage drops. As a result of this drop in output voltage, the foldback circuit operates, output voltage drops further and output current decreases.

<CE Pin>

The XC6504 internal circuitry can be shutdown via the signal from the CE pin with the XC6504 series. In shutdown mode with CE low level voltage is input, output at the V_{OUT} pin will be pulled down to the V_{SS} level via parallel to R1 & R2 and C_L discharge resistance (R_{DCHG}).

If this IC is used with the correct output voltage for the CE pin, the logic is fixed and the IC will operate normally. However, supply current may increase as a result of through current in the IC's internal circuitry when medium voltage is input. The output voltage becomes unstable when the CE pin is opened.

<CL Auto-Discharge Function>

The XC6504 series can quickly discharge the electric charge at the output capacitor (C_L), when a low signal to the CE pin, which enables a whole IC circuit put into OFF state, is inputted via an internal switch located between the V_{OUT} pin and the V_{SS} pin. In this state, the application is protected from a glitch operation caused by the electric charge at the output capacitor (C_L).

Moreover, discharge time of the output capacitor (C_L) is set by the C_L auto-discharge resistance (R_{DCHG}) and the output capacitor (C_L). By setting time constant of a C_L auto-discharge resistance value (R_{DCHG}) and an output capacitor value (C_L) as τ ($\tau = C_L \times R_{DCHG}$), the output voltage after discharge via the internal switch is calculated by the following formulas. Please also note R_{DCHG} is depended on V_{IN} and When V_{IN} is high, R_{DCHG} is low.

$$V = V_{OUT(E)} \times e^{-t/\tau} \text{ or } t = \ln(V_{OUT(E)} / V)$$

V: Output voltage after discharge

V_{OUT(E)}: Output voltage

t: Discharge time

τ : C_L x R_{DCHG}

<Low ESR Capacitors>

The XC6504 series can provide a stable output voltage even if without C_L capacitor or with a low ESR C_L capacitor because of a built-in phase compensation circuit. In case of adding a C_L capacitor, we suggest that an output capacitor (C_L) is connected as close as possible to the V_{OUT} pin and the V_{SS} pin. When V_{IN} stabilization is needed, please place an input capacitor (C_{IN}) as close as to the V_{IN} pin and the V_{SS} pin.

■ NOTES ON USE

1. For temporary, transitional voltage drop or voltage rising phenomenon, the IC is liable to malfunction should the ratings be exceeded.
2. Where wiring impedance is high, operations may become unstable due to noise and/or phase lag depending on output current. Please keep the resistance low between V_{IN} and V_{SS} wiring in particular.
3. Please wire the input capacitor (C_{IN}) and the output capacitor (C_L) as close to the IC as possible.
4. Capacitances of these capacitors (C_{IN} , C_L) are decreased by the influences of bias voltage and ambient temperature. Care shall be taken for capacitor selection to ensure stability of phase compensation from the point of ESR influence.
5. Torex places an importance on improving our products and their reliability.
We request that users incorporate fail-safe designs and post-aging prevention treatment when using Torex products in their systems.

TYPICAL PERFORMANCE CHARACTERISTICS

Unless otherwise stated, $T_a=25^\circ\text{C}$, $V_{CE}=V_{IN}$, $I_{OUT}=1\text{mA}$, $C_{IN}=C_L=\text{open}$, V_{IN} is below.

$V_{OUT(T)} < 2.5\text{V}$: $V_{IN}=3.5\text{V}$

$V_{OUT(T)} \geq 2.5\text{V}$: $V_{IN}=V_{OUT(T)}+1.0\text{V}$

(1) Output Voltage vs. Output Current

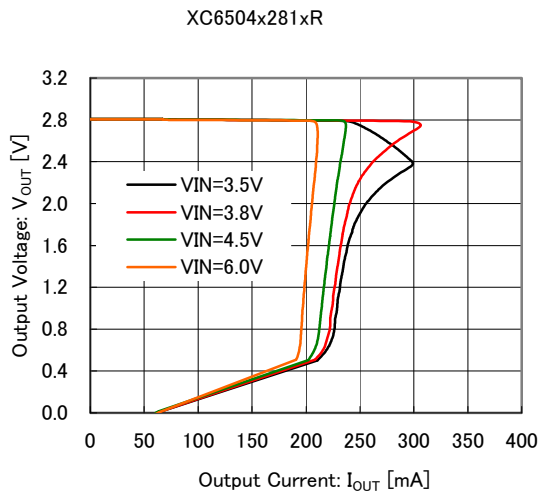
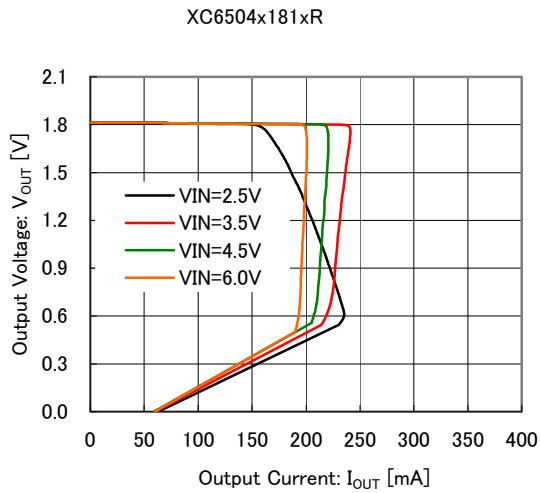
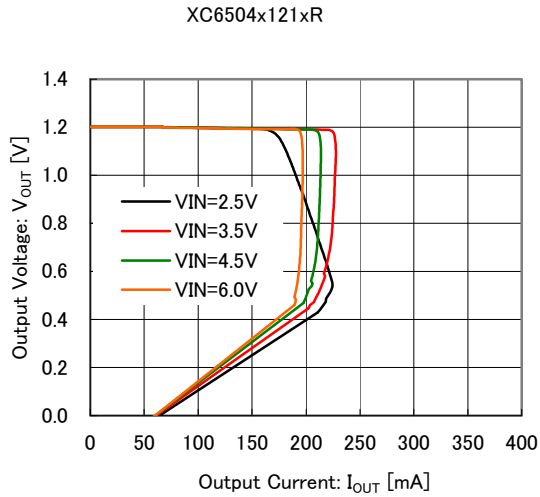

■ TYPICAL PERFORMANCE CHARACTERISTICS (Continued)

Unless otherwise stated, $T_a=25^\circ\text{C}$, $V_{CE}=V_{IN}$, $I_{OUT}=1\text{mA}$, $C_{IN}=C_L=\text{open}$, V_{IN} is below.

$V_{OUT(T)} < 2.5\text{V}$: $V_{IN}=3.5\text{V}$

$V_{OUT(T)} \geq 2.5\text{V}$: $V_{IN}=V_{OUT(T)}+1.0\text{V}$

(1) Output Voltage vs. Output Current

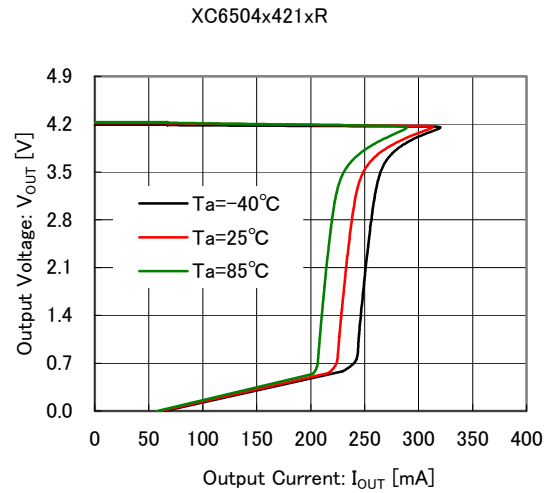
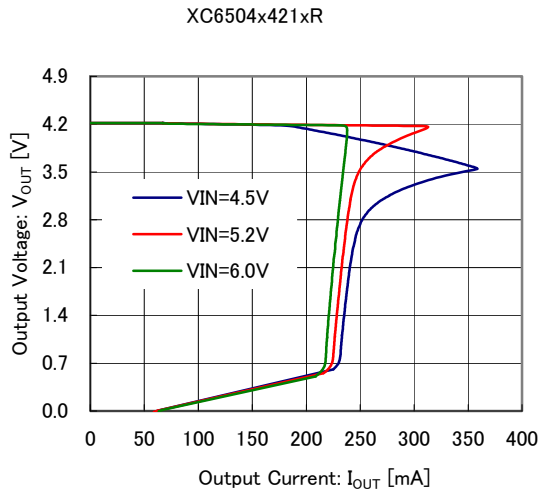

(2) Output Voltage vs. Input Voltage

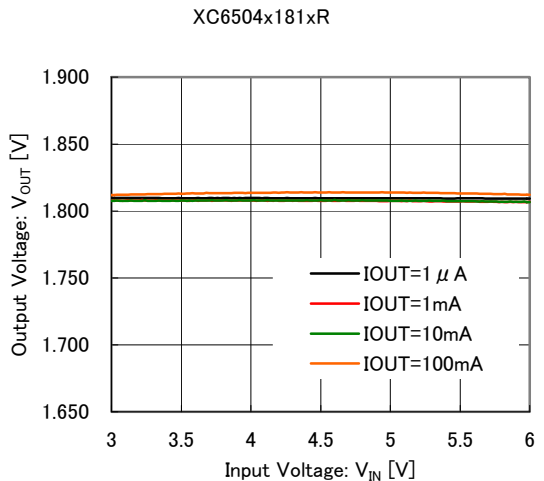
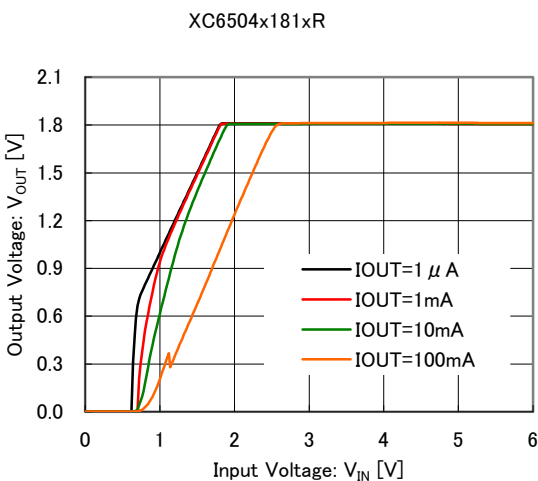
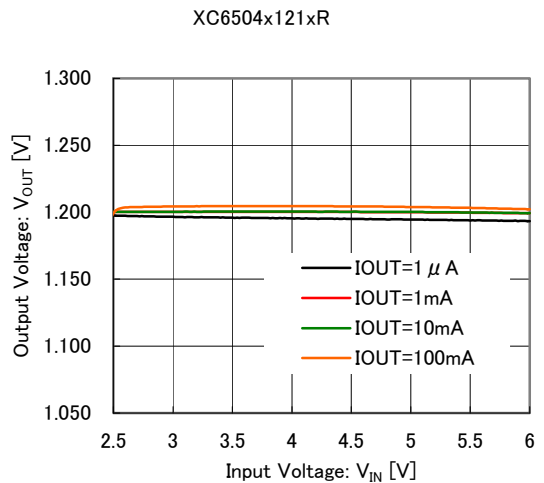
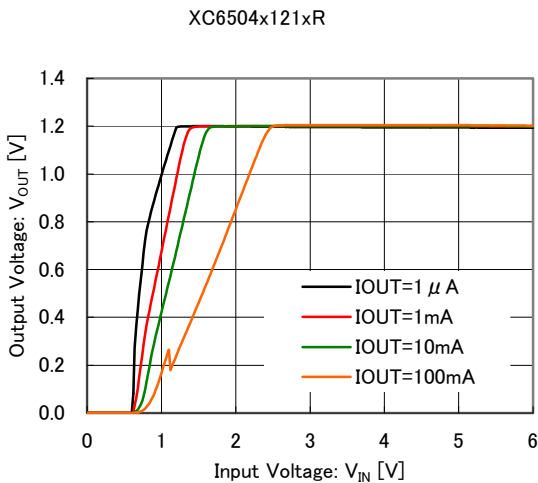

TYPICAL PERFORMANCE CHARACTERISTICS (Continued)

Unless otherwise stated, $T_a=25^\circ\text{C}$, $V_{CE}=V_{IN}$, $I_{OUT}=1\text{mA}$, $C_{IN}=C_L=\text{open}$, V_{IN} is below.

$V_{OUT(T)} < 2.5\text{V}$: $V_{IN}=3.5\text{V}$

$V_{OUT(T)} \geq 2.5\text{V}$: $V_{IN}=V_{OUT(T)}+1.0\text{V}$

(2) Output Voltage vs. Input Voltage

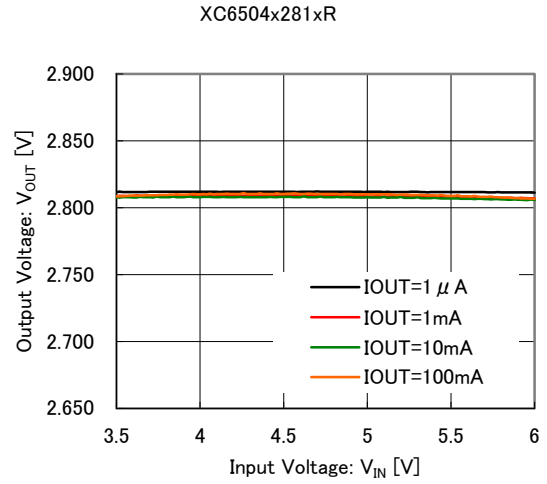
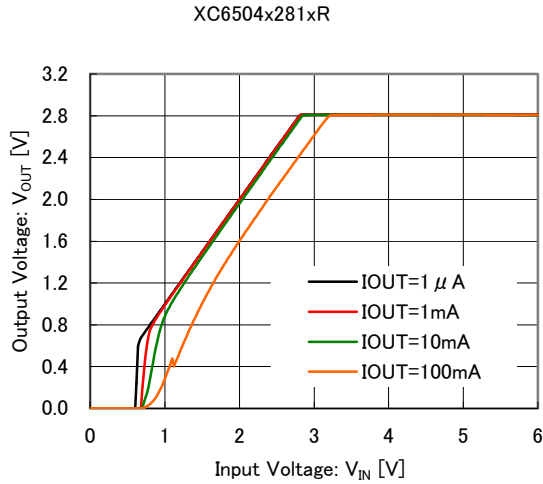

(3) Dropout Voltage vs. Output Current

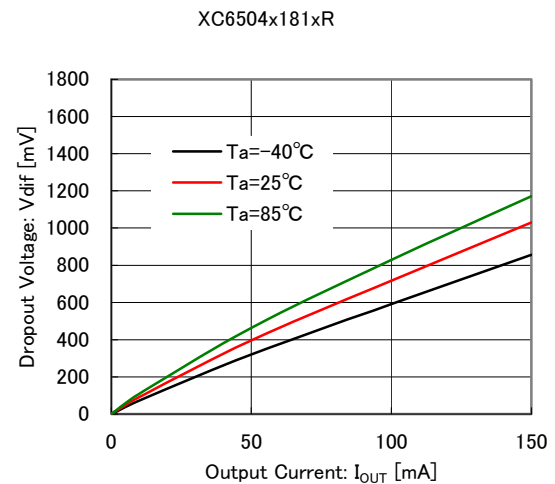
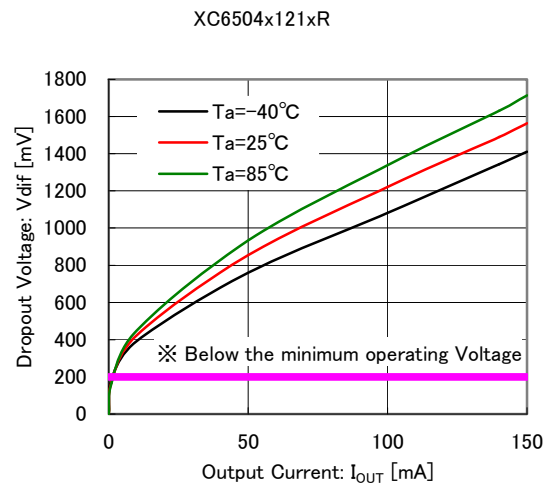

■ TYPICAL PERFORMANCE CHARACTERISTICS (Continued)

Unless otherwise stated, $T_a=25^\circ\text{C}$, $V_{CE}=V_{IN}$, $I_{OUT}=1\text{mA}$, $C_{IN}=C_L=\text{open}$, V_{IN} is below.

$V_{OUT(T)} < 2.5\text{V}$: $V_{IN}=3.5\text{V}$

$V_{OUT(T)} \geq 2.5\text{V}$: $V_{IN}=V_{OUT(T)}+1.0\text{V}$

(3) Dropout Voltage vs. Output Current

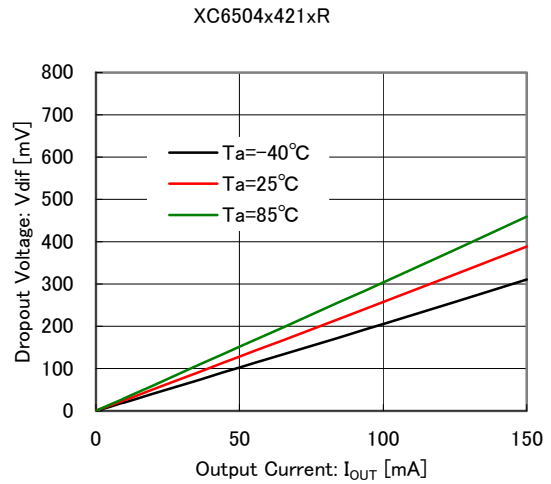
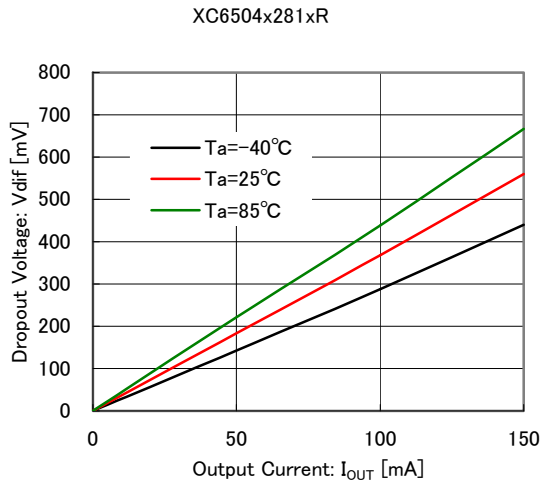

(4) Supply Current vs. Input Voltage

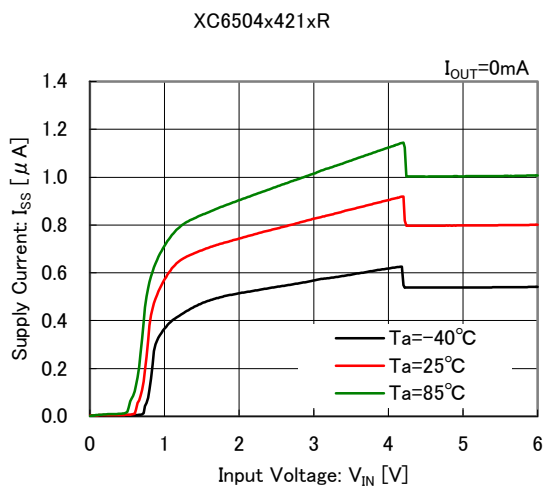
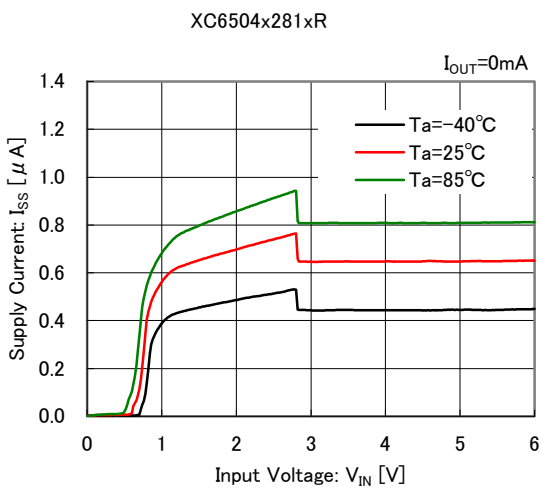
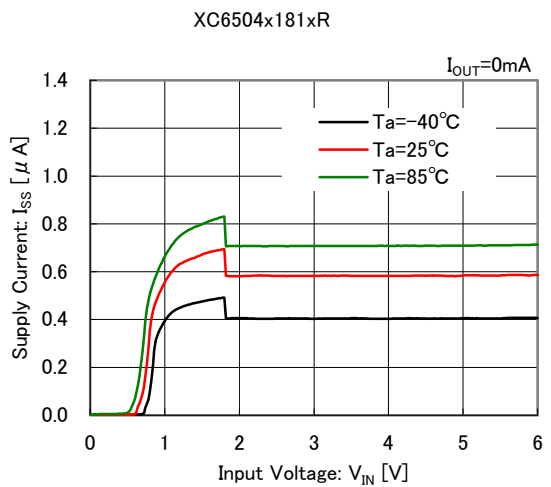
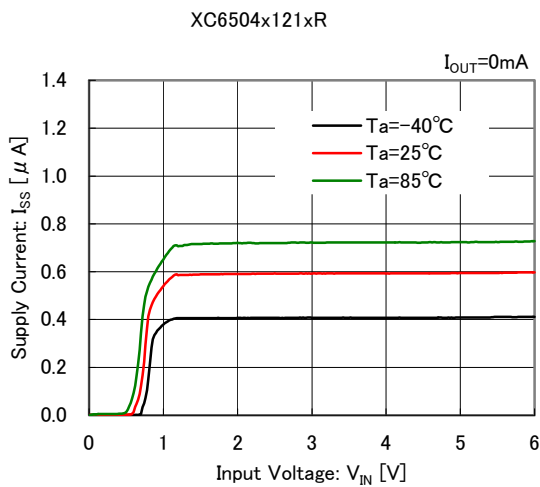

TYPICAL PERFORMANCE CHARACTERISTICS (Continued)

Unless otherwise stated, $T_a=25^\circ\text{C}$, $V_{CE}=V_{IN}$, $I_{OUT}=1\text{mA}$, $C_{IN}=C_L=\text{open}$, V_{IN} is below.

$V_{OUT(T)} < 2.5\text{V}$: $V_{IN}=3.5\text{V}$

$V_{OUT(T)} \geq 2.5\text{V}$: $V_{IN}=V_{OUT(T)}+1.0\text{V}$

(5) Supply Current vs. Output Current

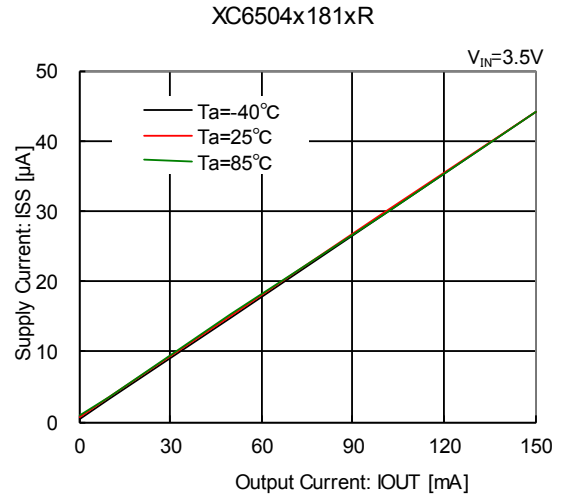
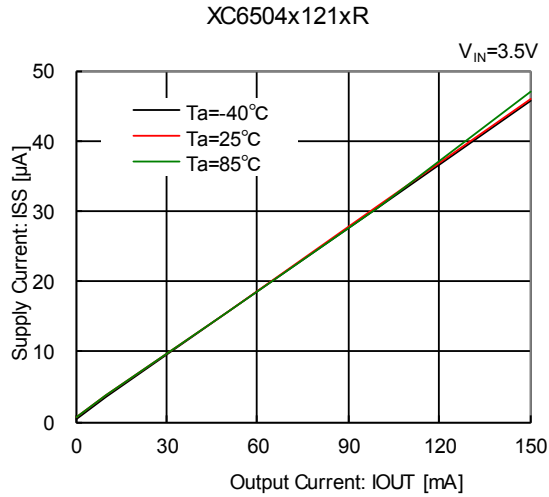

■ TYPICAL PERFORMANCE CHARACTERISTICS (Continued)

Unless otherwise stated, $T_a=25^\circ\text{C}$, $V_{CE}=V_{IN}$, $I_{OUT}=1\text{mA}$, $C_{IN}=C_L=\text{open}$, V_{IN} is below.

$V_{OUT(T)} < 2.5\text{V}$: $V_{IN}=3.5\text{V}$

$V_{OUT(T)} \geq 2.5\text{V}$: $V_{IN}=V_{OUT(T)}+1.0\text{V}$

(6) Output Voltage vs. Ambient Temperature

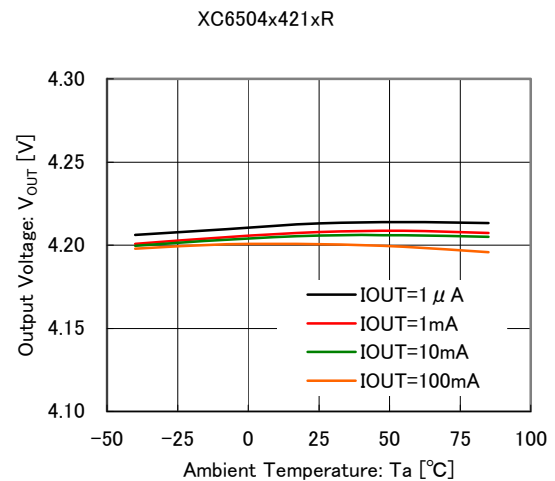
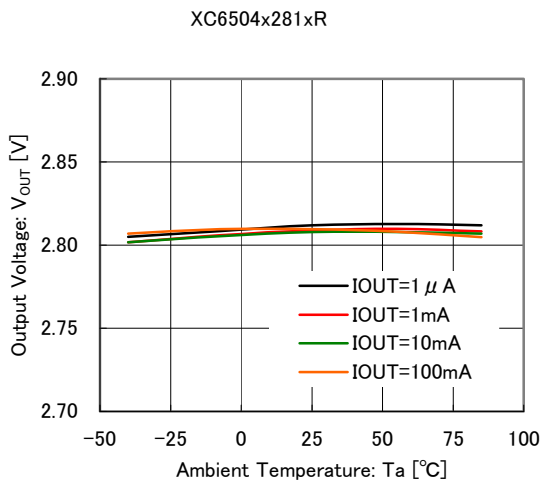
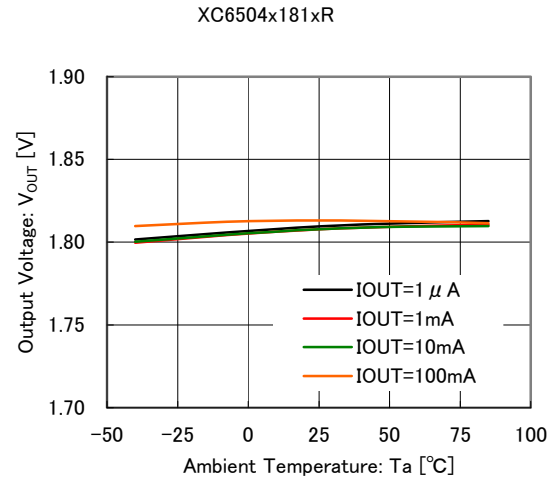
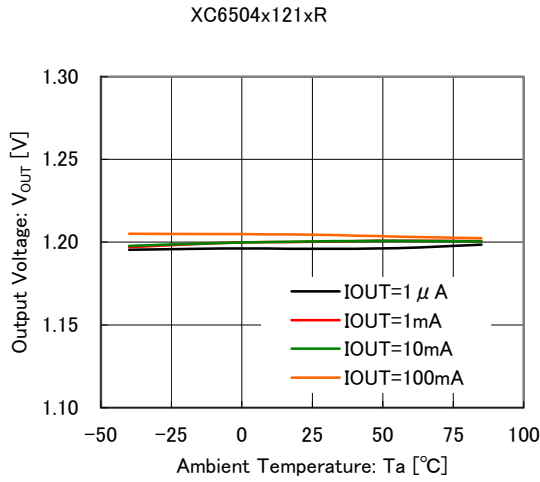

(7) Supply Current vs. Ambient Temperature

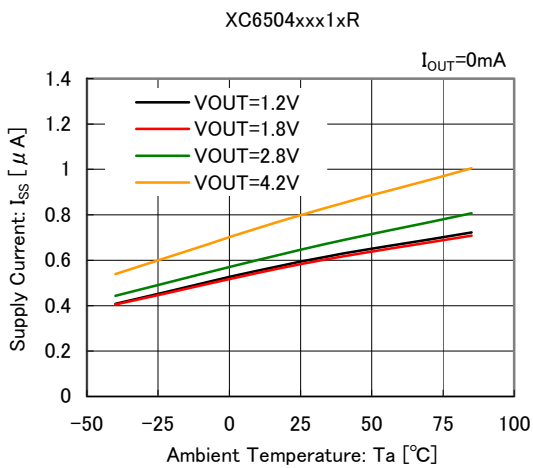

(8) CE Threshold Voltage vs. Ambient Temperature



TYPICAL PERFORMANCE CHARACTERISTICS (Continued)

Unless otherwise stated, $T_a=25^\circ\text{C}$, $V_{CE}=V_{IN}$, $I_{OUT}=1\text{mA}$, $C_{IN}=C_L=\text{open}$, V_{IN} is below.

$V_{OUT(T)} < 2.5\text{V}$: $V_{IN}=3.5\text{V}$

$V_{OUT(T)} \geq 2.5\text{V}$: $V_{IN}=V_{OUT(T)}+1.0\text{V}$

(9) Rising Response Time



(10) Input Transient Response



■ TYPICAL PERFORMANCE CHARACTERISTICS (Continued)

Unless otherwise stated, $T_a=25^\circ\text{C}$, $V_{CE}=V_{IN}$, $I_{OUT}=1\text{mA}$, $C_{IN}=C_L=\text{open}$, V_{IN} is below.

$V_{OUT(T)} < 2.5\text{V}$: $V_{IN}=3.5\text{V}$

$V_{OUT(T)} \geq 2.5\text{V}$: $V_{IN}=V_{OUT(T)}+1.0\text{V}$

(10) Input Transient Response

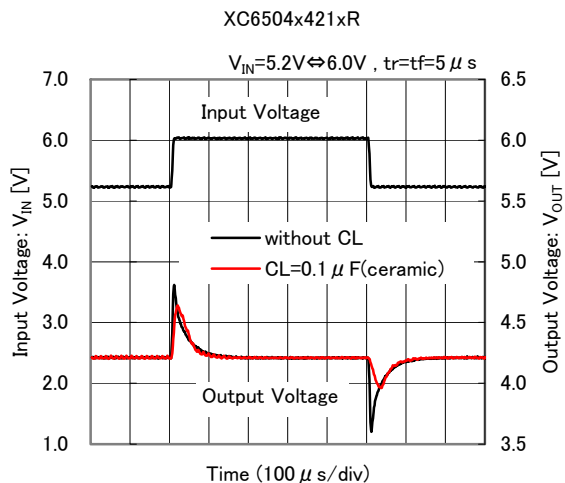
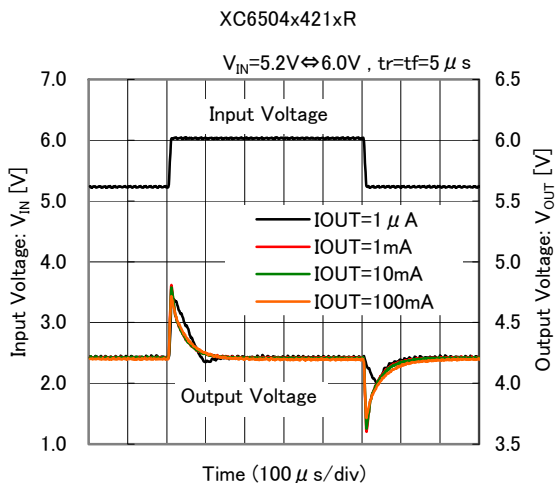
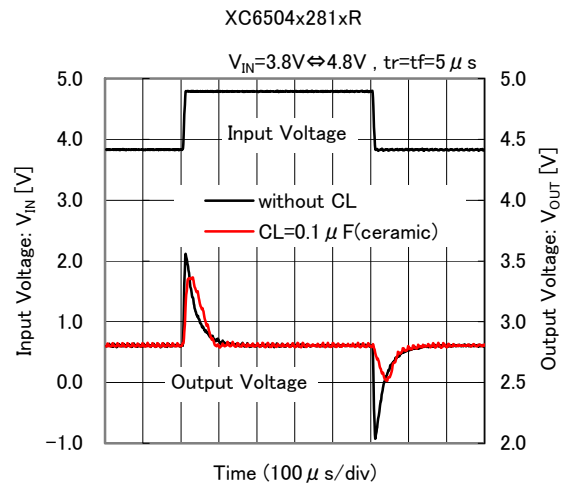
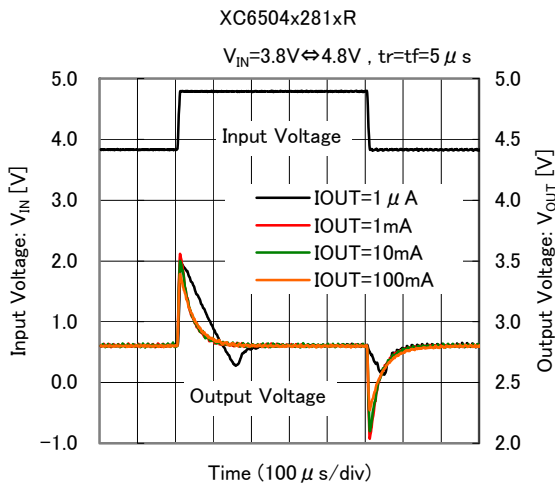
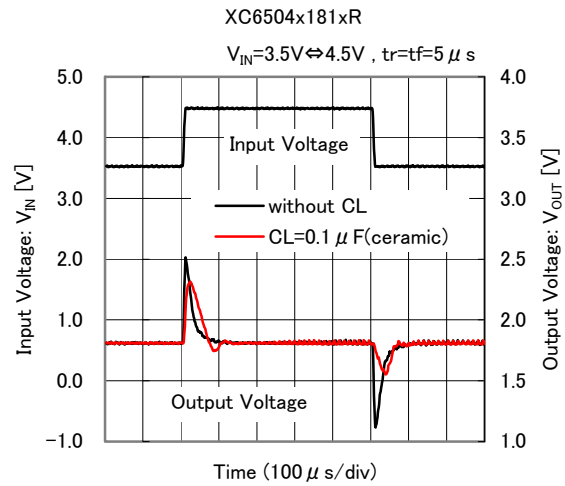
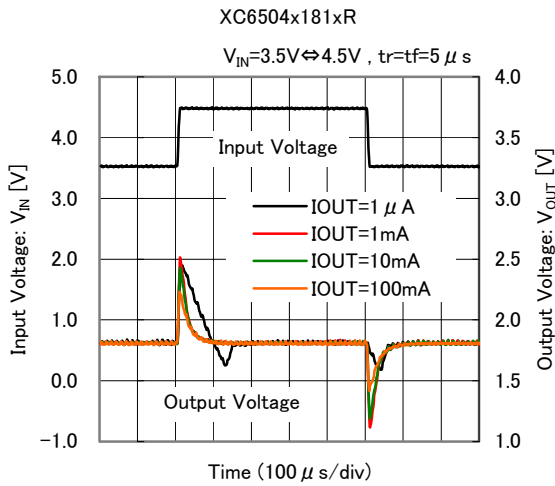

TYPICAL PERFORMANCE CHARACTERISTICS (Continued)

Unless otherwise stated, $T_a=25^\circ\text{C}$, $V_{CE}=V_{IN}$, $I_{OUT}=1\text{mA}$, $C_{IN}=C_L=\text{open}$, V_{IN} is below.

$V_{OUT(T)} < 2.5\text{V}$: $V_{IN}=3.5\text{V}$

$V_{OUT(T)} \geq 2.5\text{V}$: $V_{IN}=V_{OUT(T)}+1.0\text{V}$

(11) Load Transient Response



■ TYPICAL PERFORMANCE CHARACTERISTICS (Continued)

Unless otherwise stated, $T_a=25^\circ\text{C}$, $V_{CE}=V_{IN}$, $I_{OUT}=1\text{mA}$, $C_{IN}=C_L=\text{open}$, V_{IN} is below.

$V_{OUT(T)} < 2.5\text{V}$: $V_{IN}=3.5\text{V}$

$V_{OUT(T)} \geq 2.5\text{V}$: $V_{IN}=V_{OUT(T)}+1.0\text{V}$

(11) Load Transient Response

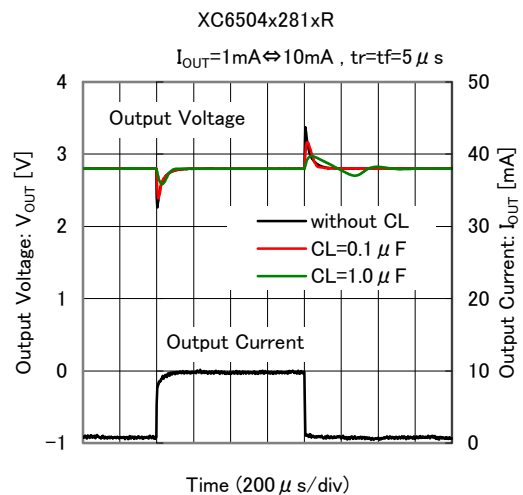
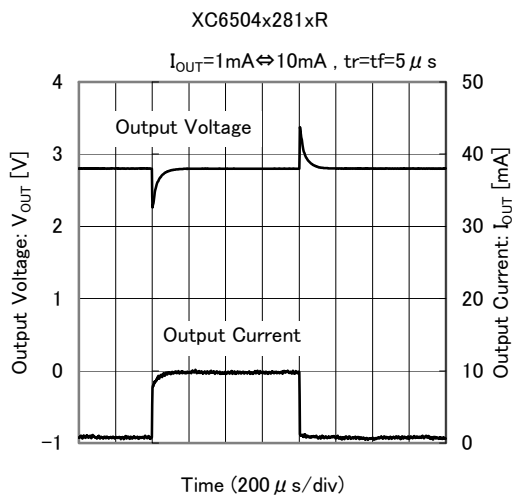
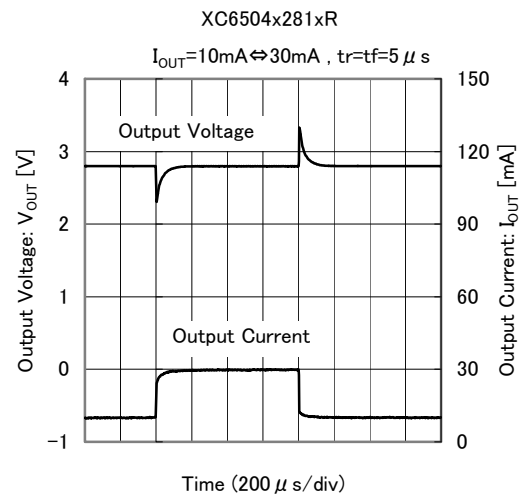
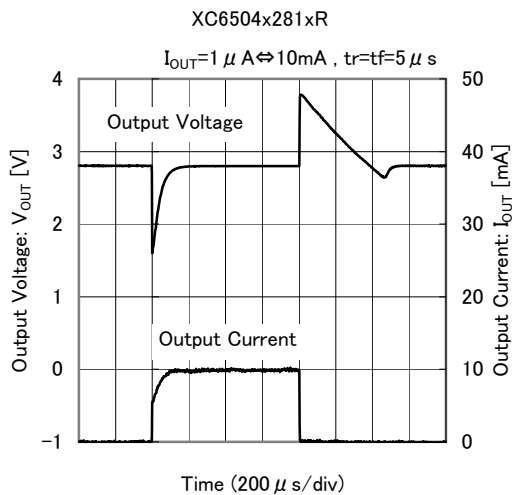
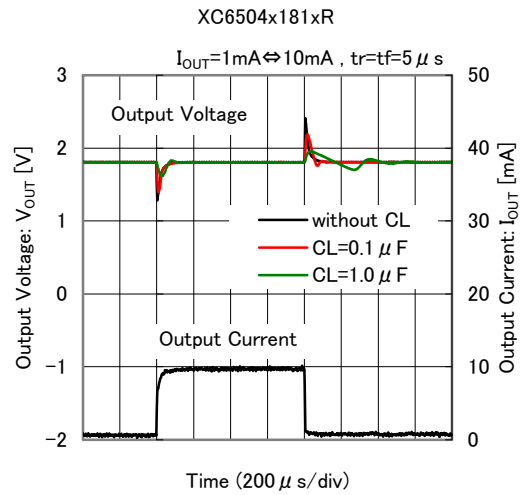
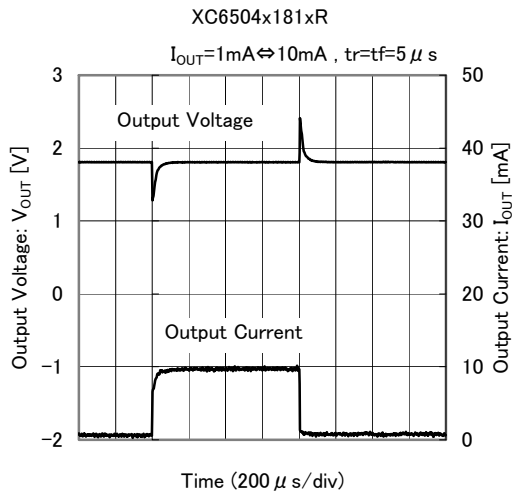

TYPICAL PERFORMANCE CHARACTERISTICS (Continued)

Unless otherwise stated, $T_a=25^\circ\text{C}$, $V_{CE}=V_{IN}$, $I_{OUT}=1\text{mA}$, $C_{IN}=C_L=\text{open}$, V_{IN} is below.

$V_{OUT(T)} < 2.5\text{V}$: $V_{IN}=3.5\text{V}$

$V_{OUT(T)} \geq 2.5\text{V}$: $V_{IN}=V_{OUT(T)}+1.0\text{V}$

(11) Load Transient Response

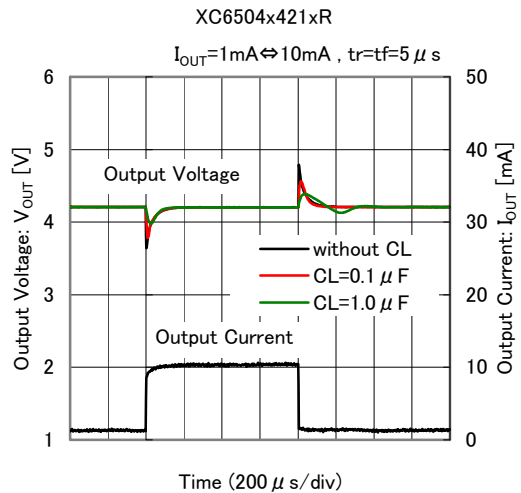
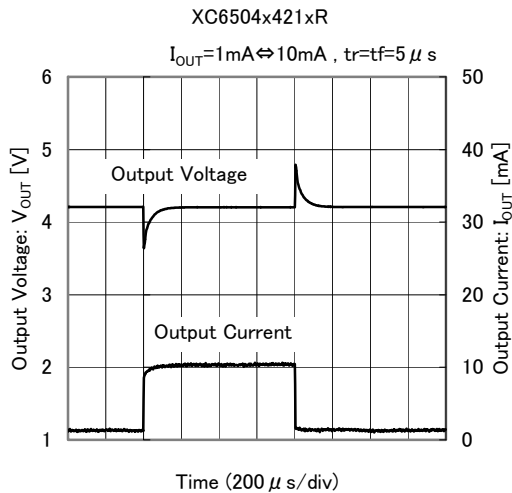
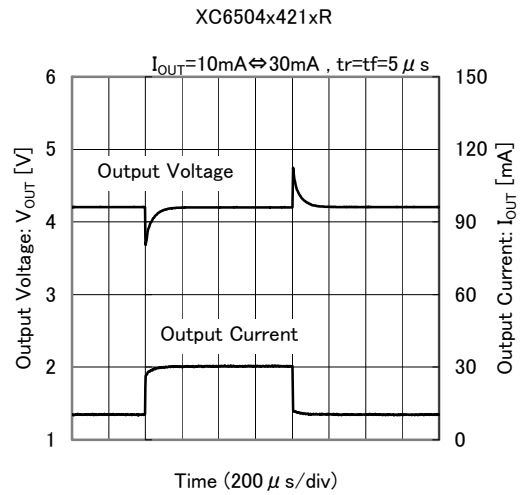
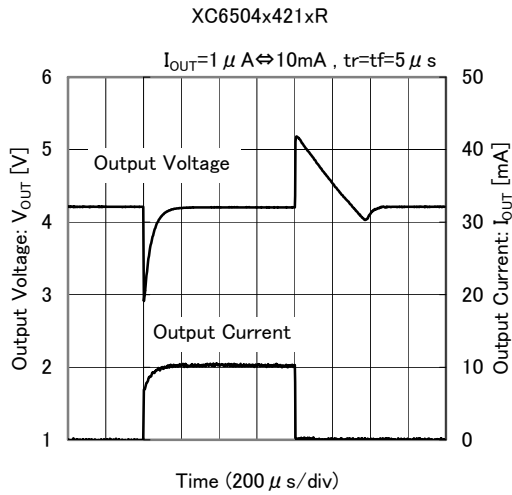

(12) CE Rising Response Time

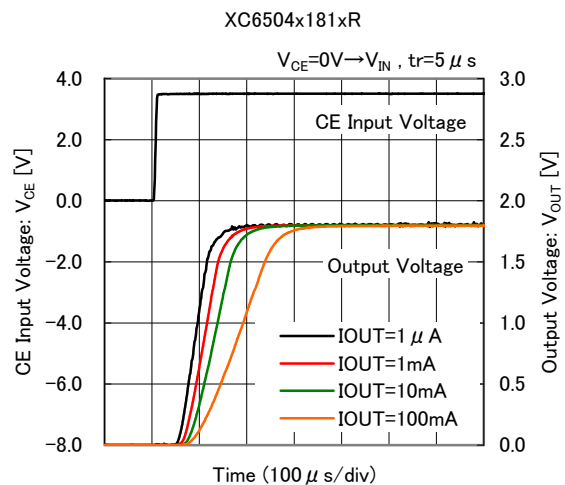

■ TYPICAL PERFORMANCE CHARACTERISTICS (Continued)

Unless otherwise stated, $T_a=25^\circ\text{C}$, $V_{CE}=V_{IN}$, $I_{OUT}=1\text{mA}$, $C_{IN}=C_L=\text{open}$, V_{IN} is below.

$V_{OUT(T)} < 2.5\text{V}$: $V_{IN}=3.5\text{V}$

$V_{OUT(T)} \geq 2.5\text{V}$: $V_{IN}=V_{OUT(T)}+1.0\text{V}$

(12) CE Rising Response Time

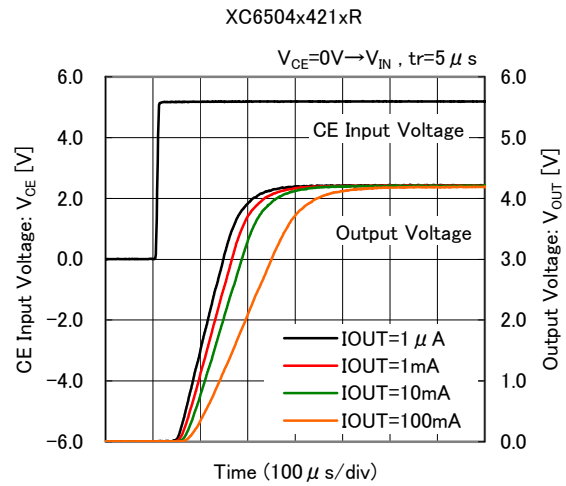
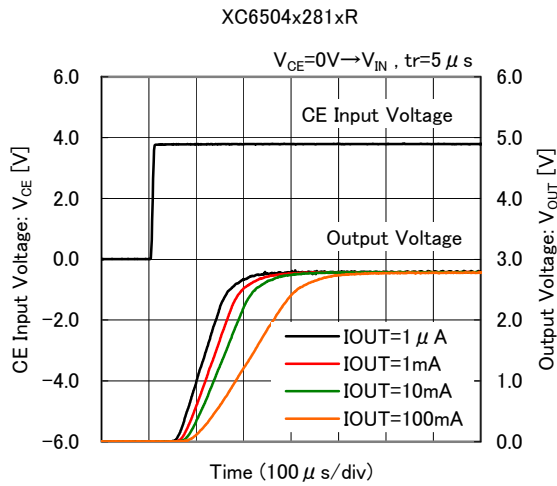

(13) Power Supply Rejection Ratio

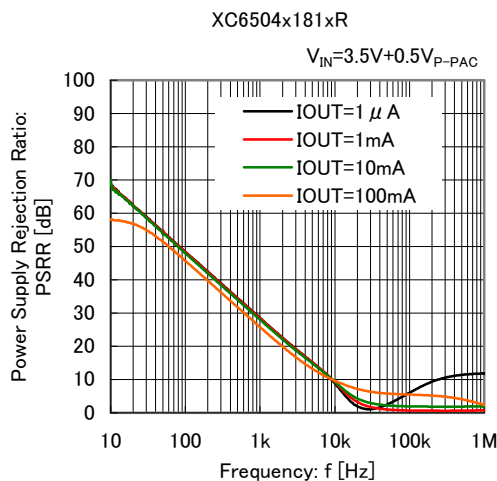
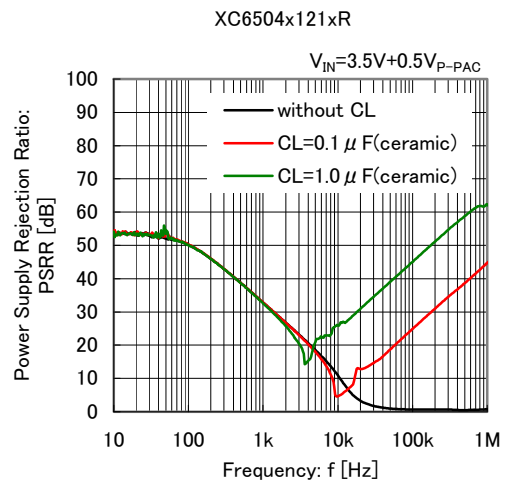
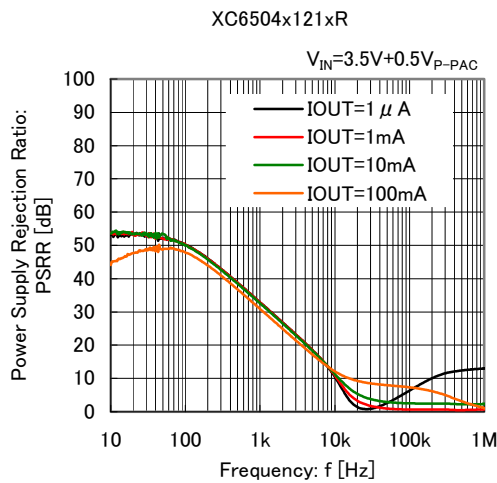

TYPICAL PERFORMANCE CHARACTERISTICS (Continued)

Unless otherwise stated, $T_a=25^\circ\text{C}$, $V_{CE}=V_{IN}$, $I_{OUT}=1\text{mA}$, $C_{IN}=C_L=\text{open}$, V_{IN} is below.

$V_{OUT(T)} < 2.5\text{V}$: $V_{IN}=3.5\text{V}$

$V_{OUT(T)} \geq 2.5\text{V}$: $V_{IN}=V_{OUT(T)}+1.0\text{V}$

(13) Power Supply Rejection Ratio



■ PACKAGING INFORMATION

● USPQ-4B04 (unit:mm)



● USPQ-4B04 Reference Pattern Layout

● USPQ-4B04 Reference Metal Mask Design

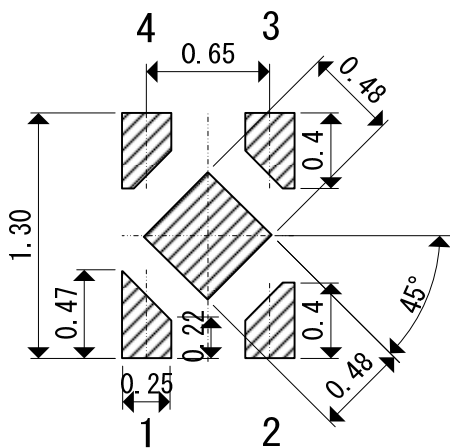

PACKAGING INFORMATION (Continued)

●USPN-4B02 (unit: mm)



●USPN-4B02 Reference Pattern Layout

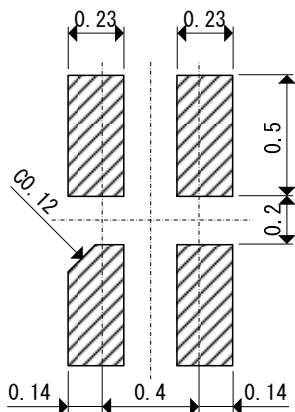

●USPN-4B02 Reference Metal Mask Design

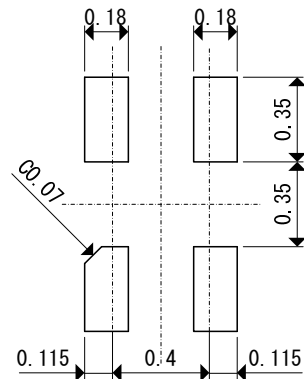

■ PACKAGING INFORMATION (Continued)

● SSOT-24 (unit: mm)



● SOT-25 (unit: mm)



PACKAGING INFORMATION (Continued)

● USPQ-4B04 Power Dissipation (40mm x 40mm Standard board)

Power dissipation data for the USPQ-4B03/04/05, UFN-4A01 is shown in this page.
 The value of power dissipation varies with the mount board conditions.
 Please use this data as the reference data taken in the following condition.

1. Measurement Condition

- Condition: Mount on a board
- Ambient: Natural convection
- Soldering: Lead (Pb) free
- Board: Dimensions 40 x 40 mm
(1600 mm² in one side)
- 4 Copper Layers
- Each layer is connected to the package heat-sink and terminal pin No.1.
- Each layer has approximately 800mm² copper area
- Material: Glass Epoxy (FR-4)
- Thickness: 1.6mm
- Through-hole: 4 x 0.8 Diameter



Evaluation Board (Unit: mm)

2. Power Dissipation vs. Ambient Temperature

Board Mount ($T_j \text{ max} = 125^\circ\text{C}$)

| Ambient Temperature ($^\circ\text{C}$) | Power Dissipation P_d (mW) | Thermal Resistance ($^\circ\text{C}/\text{W}$) |
|--|------------------------------|--|
| 25 | 550 | 181.82 |
| 85 | 220 | |



PACKAGING INFORMATION (Continued)

USPN-4B02 Power Dissipation (40mm x 40mm Standard board)

Power dissipation data for the USPN-4B02 is shown in this page.
The value of power dissipation varies with the mount board conditions.
Please use this data as the reference data taken in the following condition.

1. Measurement Condition

- Condition : Mount on a board
- Ambient : Natural convection
- Soldering : Lead (Pb) free
- Board: Dimensions 40 x 40 mm
(1600 mm² in one side)
- Copper (Cu) traces occupy 50% of the front and 50% of the back.
- The copper area is divided into four block, one block is 12.5% of total.
- The USPN-4 package has for terminals.
- Each terminal connects one copper block in the front and one in the back.
- Material: Glass Epoxy (FR-4)
- Thickness: 1.6 mm
- Through-hole: 4 x 0.4 Diameter



Evaluation Board (Unit: mm)

2. Power Dissipation vs. Ambient Temperature

Board Mount (T_j max = 125°C)

| Ambient Temperature (°C) | Power Dissipation Pd (mW) | Thermal Resistance (°C/W) |
|--------------------------|---------------------------|---------------------------|
| 25 | 550 | 181.82 |
| 85 | 220 | |

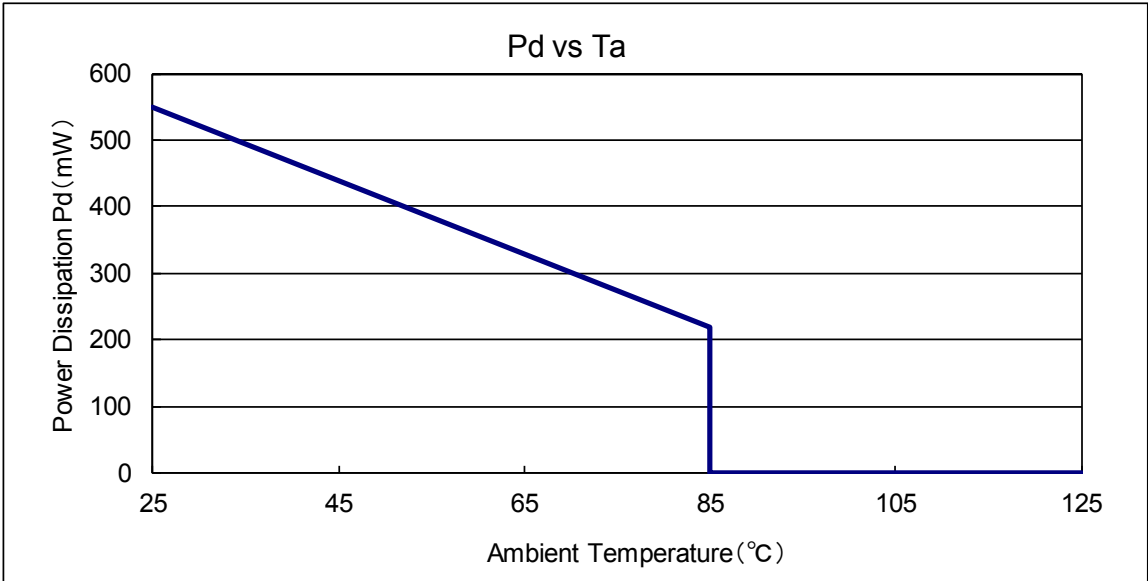

PACKAGING INFORMATION (Continued)

SSOT-24 Power Dissipation(40mm x 40mm Standard board)

Power dissipation data for the SSOT-24 is shown in this page.
 The value of power dissipation varies with the mount board conditions.
 Please use this data as the reference data taken in the following condition.

1. Measurement Condition

- Condition : Mount on a board
- Ambient : Natural convection
- Soldering : Lead (Pb) free
- Board : Dimensions 40 x 40 mm
 (1600 mm² in one side)
- Copper (Cu) traces occupy 50% of the board
 area in top and back faces
- Package heat-sink is tied to the copper traces
- Material : Glass Epoxy (FR-4)
- Thickness : 1.6mm
- Through-hole : 4 x 0.8 Diameter

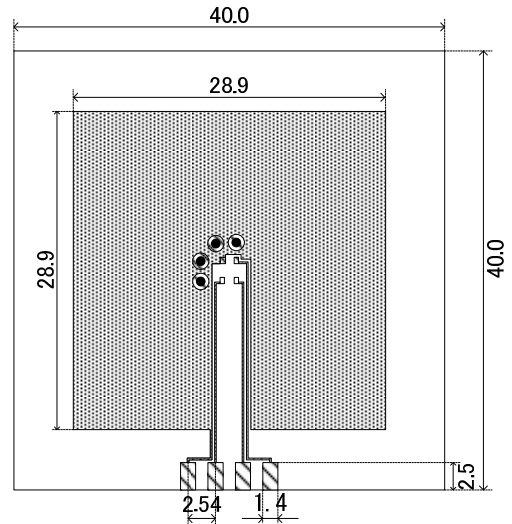

Evaluation Board (Unit: mm)

2. Power Dissipation vs. Ambient Temperature

Board Mount (T_j max = 125°C)

| Ambient Temperature (°C) | Power Dissipation Pd (mW) | Thermal Resistance (°C/W) |
|--------------------------|---------------------------|---------------------------|
| 25 | 500 | 200.00 |
| 85 | 200 | |

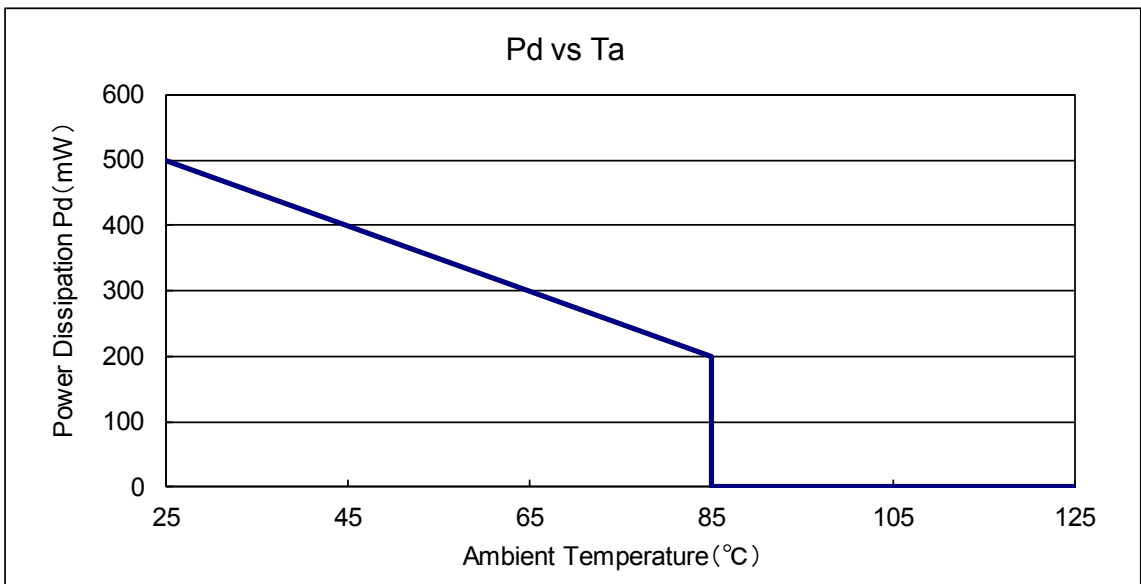

PACKAGING INFORMATION (Continued)

SOT-25 Power Dissipation (40mm x 40mm Standard board)

Power dissipation data for the SOT-25 is shown in this page.
The value of power dissipation varies with the mount board conditions.
Please use this data as the reference data taken in the following condition.

1. Measurement Condition

- Condition: Mount on a board
- Ambient: Natural convection
- Soldering: Lead (Pb) free
- Board: Dimensions 40 x 40 mm
(1600 mm² in one side)
- Copper (Cu) traces occupy 50% of the board area in top and back faces
- Package heat-sink is tied to the copper traces
(Board of SOT-26 is used.)
- Material: Glass Epoxy (FR-4)
- Thickness: 1.6mm
- Through-hole: 4 x 0.8 Diameter

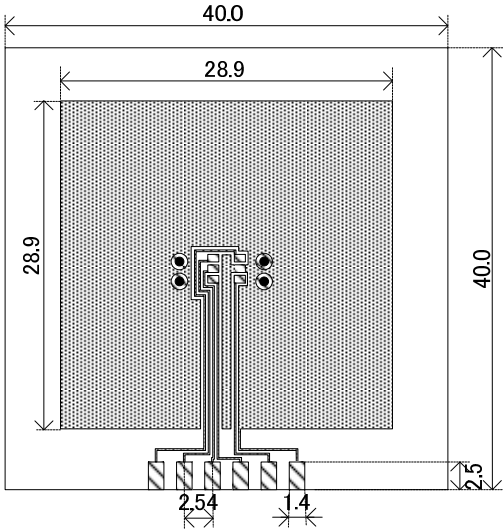

Evaluation Board (Unit: mm)

2. Power Dissipation vs. Ambient Temperature

Board Mount (T_j max = 125°C)

| Ambient Temperature (°C) | Power Dissipation Pd (mW) | Thermal Resistance (°C/W) |
|--------------------------|---------------------------|---------------------------|
| 25 | 600 | 166.67 |
| 85 | 240 | |

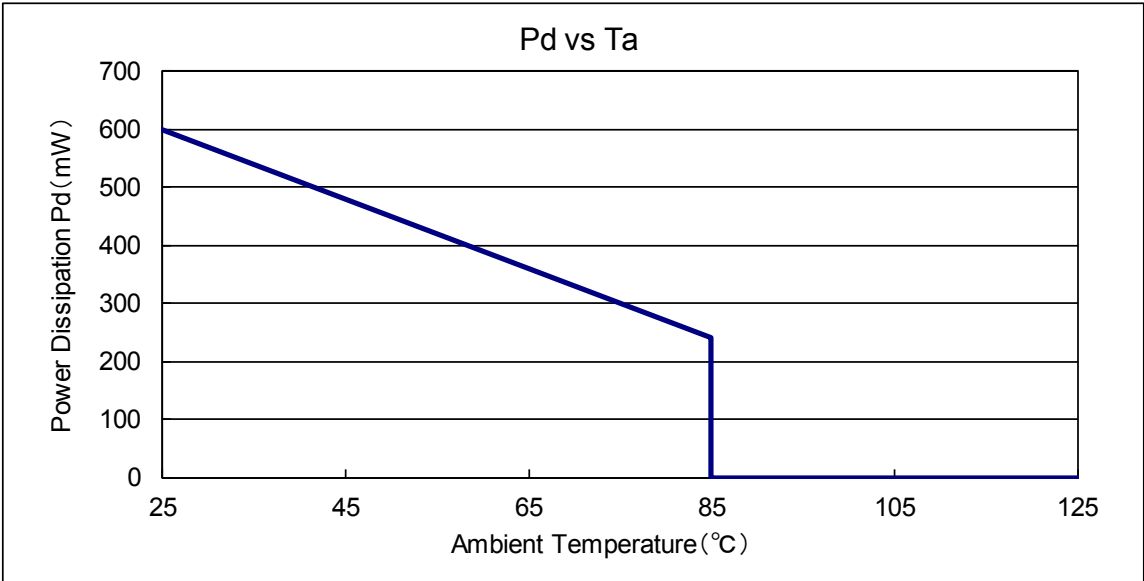

MARKING RULE

SOT-25 (Under-dot)



* SOT-25 with the under-dot marking is used.

① represents products series

| MARK | PRODUCT SERIES |
|------|----------------|
| 9 | XC6504A****-G |

② represents output voltage range

| MARK | | PRODUCT SERIES |
|----------------|----------------|----------------|
| OUTPUT VOLTAGE | OUTPUT VOLTAGE | |
| 1.1V~3.9V | 4.0V~5.0V | XC6504A****-G |
| A | B | |

③ represents output voltage

| MARK | OUTPUT VOLTAGE (V) | | MARK | OUTPUT VOLTAGE (V) | |
|------|--------------------|------|------|--------------------|---|
| 0 | - | 4.00 | F | 2.50 | - |
| 1 | 1.10 | 4.10 | H | 2.60 | - |
| 2 | 1.20 | 4.20 | K | 2.70 | - |
| 3 | 1.30 | 4.30 | L | 2.80 | - |
| 4 | 1.40 | 4.40 | M | 2.90 | - |
| 5 | 1.50 | 4.50 | N | 3.00 | - |
| 6 | 1.60 | 4.60 | P | 3.10 | - |
| 7 | 1.70 | 4.70 | R | 3.20 | - |
| 8 | 1.80 | 4.80 | S | 3.30 | - |
| 9 | 1.90 | 4.90 | T | 3.40 | - |
| A | 2.00 | 5.00 | U | 3.50 | - |
| B | 2.10 | - | V | 3.60 | - |
| C | 2.20 | - | X | 3.70 | - |
| D | 2.30 | - | Y | 3.80 | - |
| E | 2.40 | - | Z | 3.90 | - |

④,⑤ represents production lot number

01~09, 0A~0Z, 11~9Z, A1~A9, AA~AZ, B1~ZZ in order.

(G, I, J, O, Q, W excluded)

*No character inversion used.

MARKING RULE (Continued)

● SSOT-24 (With the orientation bar at the bottom)



● USPQ-4B04



* SSOT-24 with the orientation bar at the bottom is used.

① represents output voltage range

| MARK | | PRODUCT SERIES |
|-----------------------------|-----------------------------|----------------|
| OUTPUT VOLTAGE 1.1V~3.9V | OUTPUT VOLTAGE 4.0V~5.0V | |
| P | R | XC6504A****-G |

② represents output voltage

| MARK | OUTPUT VOLTAGE (V) | | MARK | OUTPUT VOLTAGE (V) | |
|------|--------------------|------|------|--------------------|---|
| 0 | - | 4.00 | F | 2.50 | - |
| 1 | 1.10 | 4.10 | H | 2.60 | - |
| 2 | 1.20 | 4.20 | K | 2.70 | - |
| 3 | 1.30 | 4.30 | L | 2.80 | - |
| 4 | 1.40 | 4.40 | M | 2.90 | - |
| 5 | 1.50 | 4.50 | N | 3.00 | - |
| 6 | 1.60 | 4.60 | P | 3.10 | - |
| 7 | 1.70 | 4.70 | R | 3.20 | - |
| 8 | 1.80 | 4.80 | S | 3.30 | - |
| 9 | 1.90 | 4.90 | T | 3.40 | - |
| A | 2.00 | 5.00 | U | 3.50 | - |
| B | 2.10 | - | V | 3.60 | - |
| C | 2.20 | - | X | 3.70 | - |
| D | 2.30 | - | Y | 3.80 | - |
| E | 2.40 | - | Z | 3.90 | - |

③,④ represents production lot number

01~09, 0A~0Z, 11~9Z, A1~A9, AA~AZ, B1~ZZ in order.

(G, I, J, O, Q, W excluded)

*No character inversion used.

MARKING RULE (Continued)

USPN-4B02

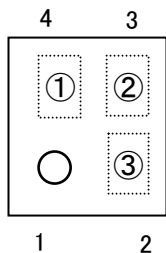

① represents output voltage range

| MARK | | PRODUCT SERIES |
|-----------------------------|-----------------------------|----------------|
| OUTPUT VOLTAGE 1.1V~3.9V | OUTPUT VOLTAGE 4.0V~5.0V | |
| A | B | XC6504A****-G |

② represents output voltage

| MARK | OUTPUT VOLTAGE (V) | | MARK | OUTPUT VOLTAGE (V) | |
|------|--------------------|------|------|--------------------|---|
| 0 | - | 4.00 | F | 2.50 | - |
| 1 | 1.10 | 4.10 | H | 2.60 | - |
| 2 | 1.20 | 4.20 | K | 2.70 | - |
| 3 | 1.30 | 4.30 | L | 2.80 | - |
| 4 | 1.40 | 4.40 | M | 2.90 | - |
| 5 | 1.50 | 4.50 | N | 3.00 | - |
| 6 | 1.60 | 4.60 | P | 3.10 | - |
| 7 | 1.70 | 4.70 | R | 3.20 | - |
| 8 | 1.80 | 4.80 | S | 3.30 | - |
| 9 | 1.90 | 4.90 | T | 3.40 | - |
| A | 2.00 | 5.00 | U | 3.50 | - |
| B | 2.10 | - | V | 3.60 | - |
| C | 2.20 | - | X | 3.70 | - |
| D | 2.30 | - | Y | 3.80 | - |
| E | 2.40 | - | Z | 3.90 | - |

③ represents production lot number

0~9, A~Z in order.

(G, I, J, O, Q, W excluded)

*No character inversion used.

1. The product and product specifications contained herein are subject to change without notice to improve performance characteristics. Consult us, or our representatives before use, to confirm that the information in this datasheet is up to date.
2. The information in this datasheet is intended to illustrate the operation and characteristics of our products. We neither make warranties or representations with respect to the accuracy or completeness of the information contained in this datasheet nor grant any license to any intellectual property rights of ours or any third party concerning with the information in this datasheet.
3. Applicable export control laws and regulations should be complied and the procedures required by such laws and regulations should also be followed, when the product or any information contained in this datasheet is exported.
4. The product is neither intended nor warranted for use in equipment of systems which require extremely high levels of quality and/or reliability and/or a malfunction or failure which may cause loss of human life, bodily injury, serious property damage including but not limited to devices or equipment used in 1) nuclear facilities, 2) aerospace industry, 3) medical facilities, 4) automobile industry and other transportation industry and 5) safety devices and safety equipment to control combustions and explosions. Do not use the product for the above use unless agreed by us in writing in advance.
5. Although we make continuous efforts to improve the quality and reliability of our products; nevertheless Semiconductors are likely to fail with a certain probability. So in order to prevent personal injury and/or property damage resulting from such failure, customers are required to incorporate adequate safety measures in their designs, such as system fail safes, redundancy and fire prevention features.
6. Our products are not designed to be Radiation-resistant.
7. Please use the product listed in this datasheet within the specified ranges.
8. We assume no responsibility for damage or loss due to abnormal use.
9. All rights reserved. No part of this datasheet may be copied or reproduced unless agreed by Torex Semiconductor Ltd in writing in advance.

TOREX SEMICONDUCTOR LTD.

单击下面可查看定价，库存，交付和生命周期等信息

[>>Torex Semiconductor\(特瑞仕\)](#)