

# DATA SHEET

WIRELESS COMPONENTS  
Ceramic Chip Antenna  
ANT1003LL15R2455A  
2.4 AND 5 GHZ  
1003 Series



FEATURES

- Compact size
- Omni-directional radiation
- Dual-band design
- Tape & reel automatic mounting
- Reflow process compatible
- RoHS compliant

APPLICATIONS

- 2.4 & 5 GHz WiFi device
- ISM band equipment

ORDERING INFORMATION

All part numbers are identified by the series, packing type, material, size, antenna type, working frequency and packing quantity.

**PART NUMBER**

**ANT 1003 L L15 R 2455A**  
 (1) (2) (3) (4) (5) (6)

---

**(1) PRODUCT**

ANT = Antenna

---

**(2) SIZE**

1003 = 10 × 3 mm

---

**(3) ANTENNA TYPE**

L,F,A=Chip Antenna

---

**(4) SERIAL NO.**

L15

---

**(5) PACKING STYLE**

R = Tape and Reel

---

**(6) WORKING FREQUENCY**

2455 = 2.4/5 GHz

---

**PHYCOMP CTC**

CAN4311756152521K

---

**I2NC**

431175615252

---

**SPECIFICATION**

Table 1

DESCRIPTION	VALUE
Centre Frequency	2.4~2.484 GHz / 5.15~5.85 GHz
Bandwidth	120/900 MHz (Typ.)
Return Loss	6.5 dB min
Polarization	Linear
Azimuth Beamwidth	Omni-directional
Peak Gain	2.45 / 1.55 dBi (Typ.)
Impedance	50 Ω
Operating Temperature	-40~105 degree
Maximum Power	1 W
Termination	Ag (Environmentally-Friendly Leadless)
Resistance to Soldering Heats	260°C , 10sec.

**NOTE**

1. The specification is defined on Yageo evaluation board

**DIMENSIONS**

Table 2 Machinical Dimension

	DIMENSION
L (mm)	10.00 ± 0.20
W (mm)	3.20 ± 0.20
T (mm)	1.60 ± 0.20

**OUTLINES**

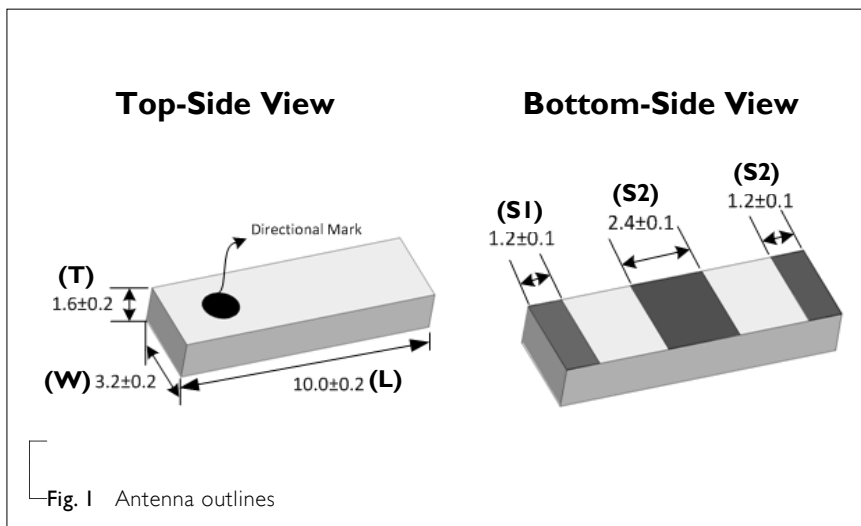

Table 3 Termination configuration

TERMINAL NAME	FUNCTION
S1	Feeding Point
S2	Soldering Point

REFERENCE DESIGN OF EVALUATION BOARD

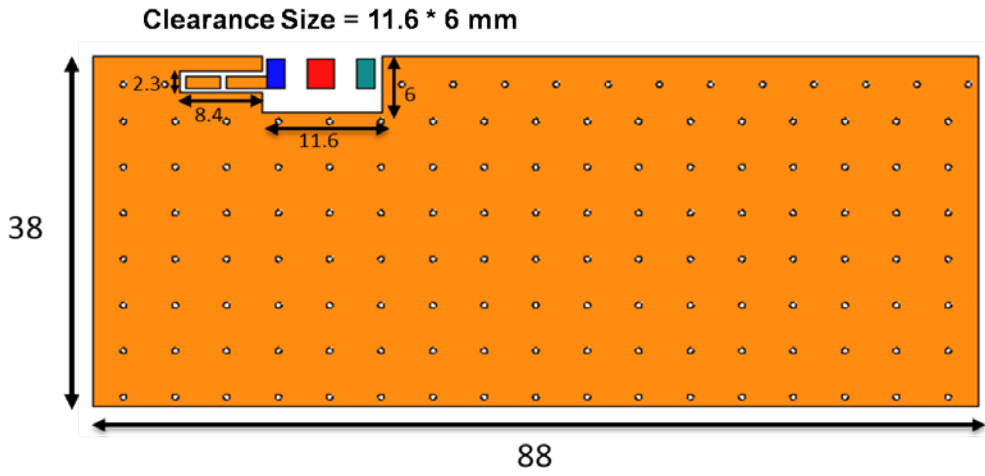

Fig. 2 Outlook and dimension of evaluation board

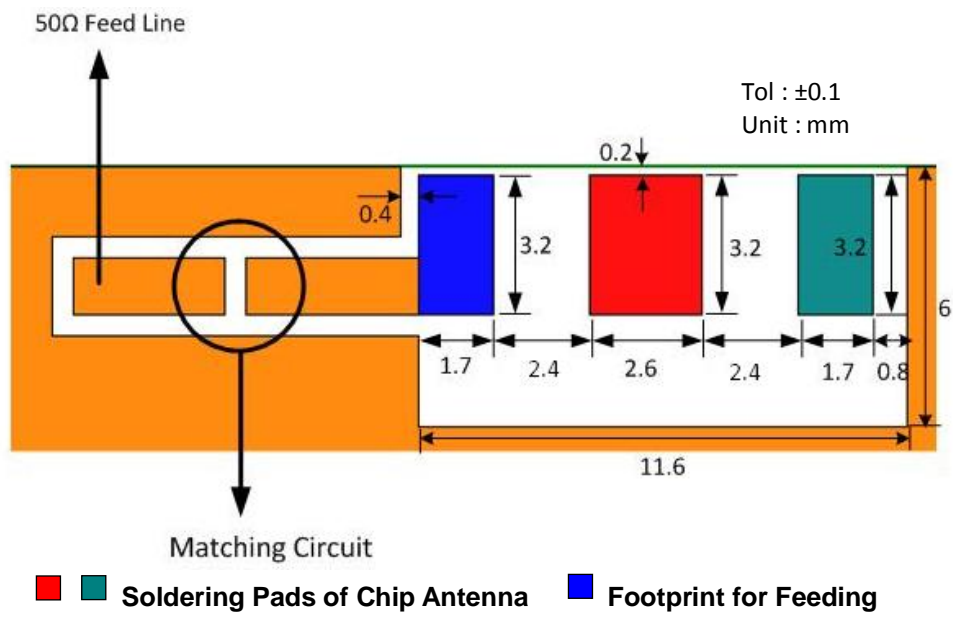

Fig. 3 Details of soldering pad

**ELECTRICAL PERFORMANCES**

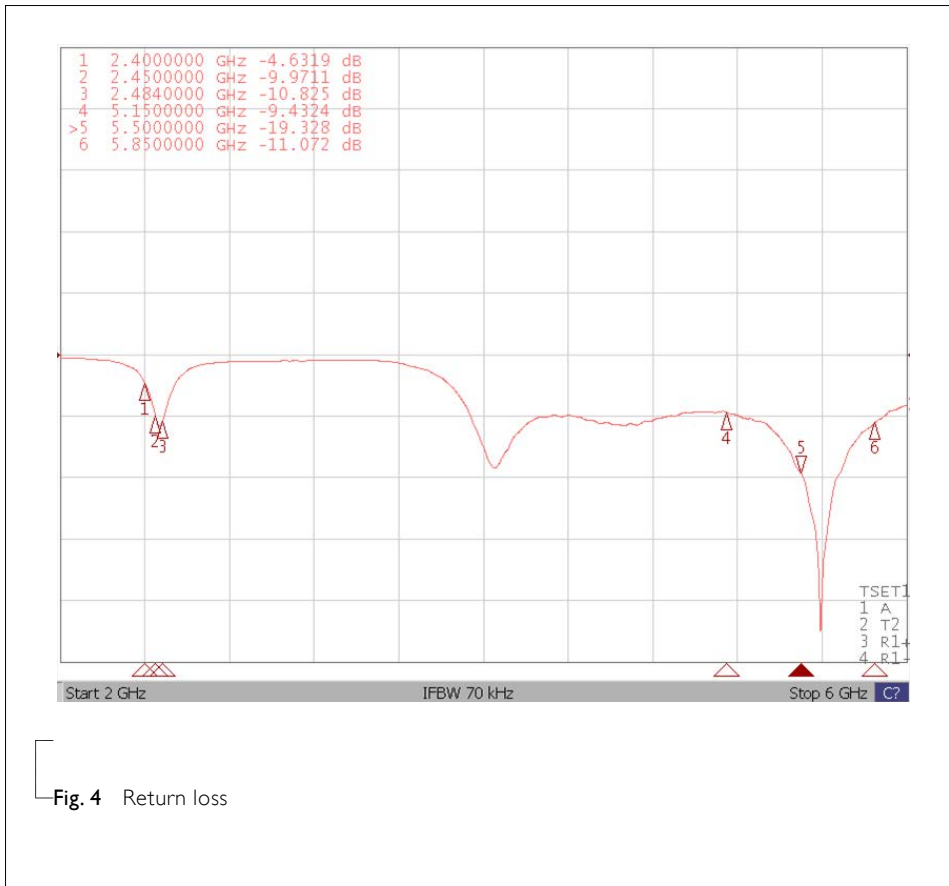

Fig. 4 Return loss

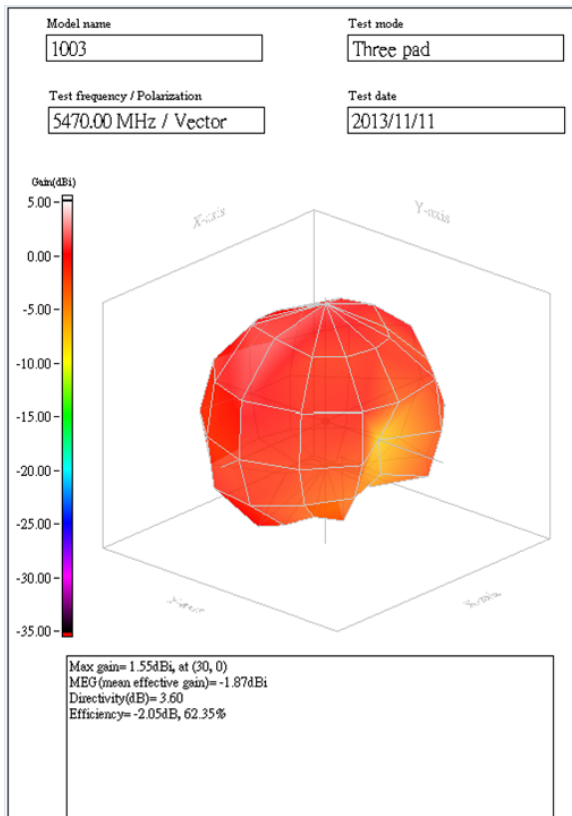
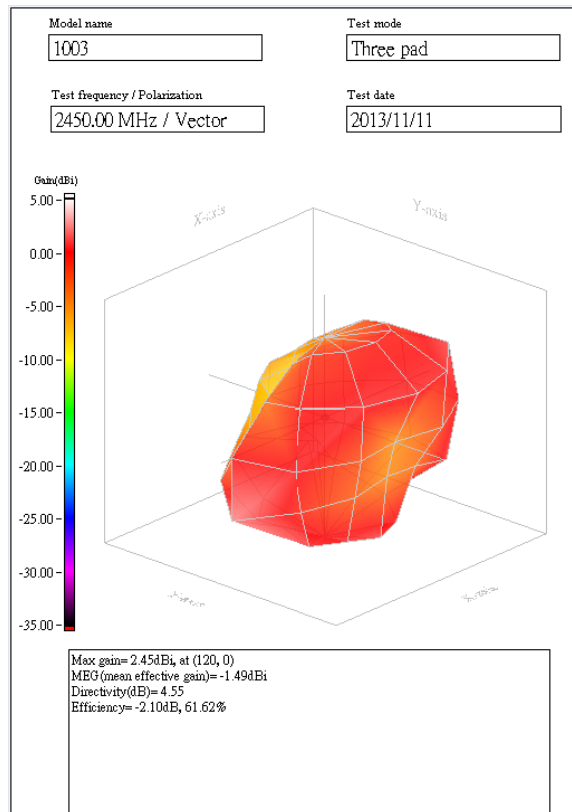
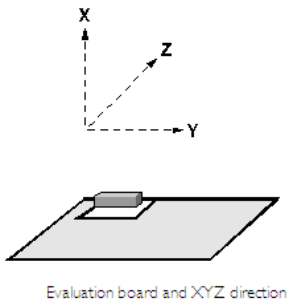

Fig. 5 Radiation pattern

REVISION HISTORY

REVISION	DATE	CHANGE NOTIFICATION	DESCRIPTION
Version 0	Nov. 20, 2013	-	- New data sheet for SMD type antenna, 2.4/5GHz application, 1003 series

单击下面可查看定价，库存，交付和生命周期等信息

[>>Yageo\(国巨\)](#)