

JSM Series Sub-Miniature Slide Switches

Features/Benefits

- RoHS compliant and meets all requirements of RoHS directive 2002/95EC, Halogen Free
- Positive detent
- Low profile
- IR reflow to 260° solder profile
- Surface and thru hole mounting
- Maintained and momentary functions
- SPDT, SP3T models

Typical Applications

- Telecommunication products
- Computer peripherals
- Thermostat select switch
- Instrumentations



Specifications

CONTACT RATING: 4 VDC @ 0.3A
 ELECTRICAL LIFE: 10,000 make-and-break cycles at full load.
 CONTACT RESISTANCE: 70 m Ω max.
 INSULATION RESISTANCE: 100 M Ω min. @ 500V.
 DIELECTRIC STRENGTH: 100 VAC min. @ sea level.
 OPERATING TEMPERATURE: -10°C to +60°C
 STORAGE TEMPERATURE: -30°C to +85°C

NOTE: Specifications and materials listed above are for switches with standard options. For information on specific and custom switches, consult Customer Service Center.

Materials

HOUSING: LCP, Glass filled (Halogen free)
 ACTUATOR: 4/6 nylon (UL94V-2), black.
 CONTACTS: Beryllium copper, silver plated.
 TERMINALS: Brass, silver plated.
 COVER: Stainless steel
 RETURN SPRING: Stainless steel

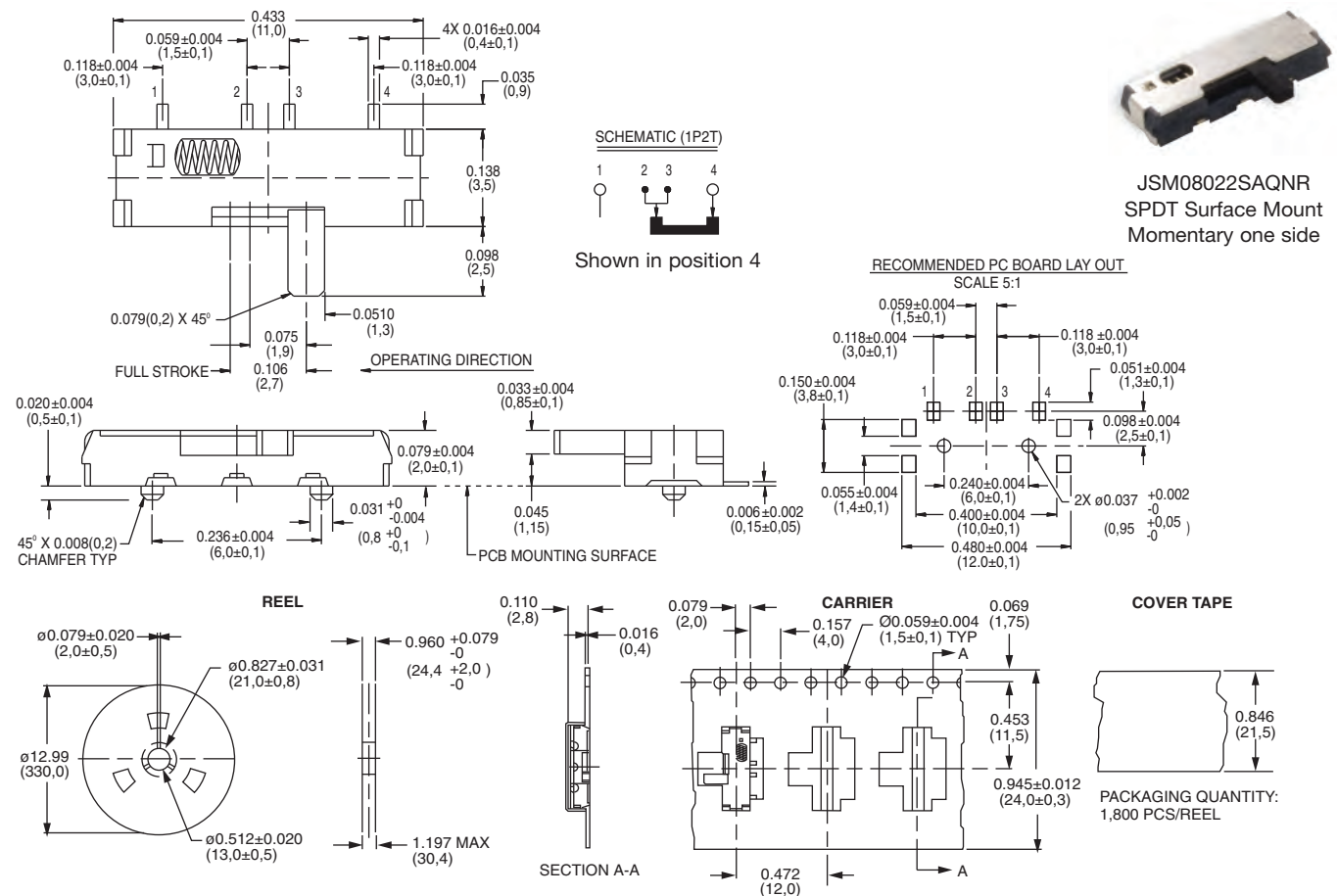

Third Angle Projection

Dimensions are shown: Inches (mm)
 Specifications and dimensions subject to change

JSM Series Sub-Miniature Slide Switches

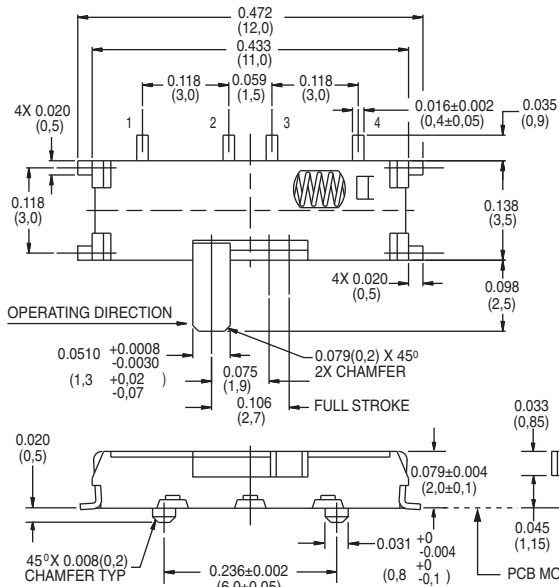

SCHEMATIC (1P2T)

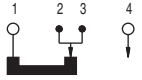

Shown in position 1



JSM08022SAQNL
SPDT Surface Mount
Momentary only

RECOMMENDED PC BOARD LAY OUT

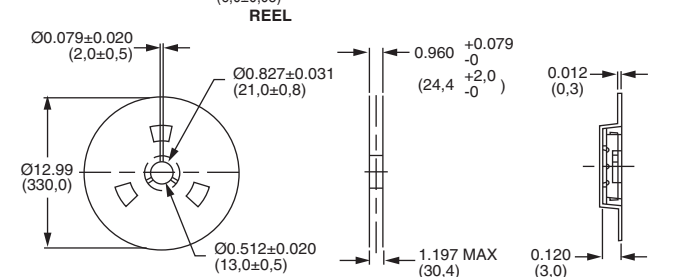
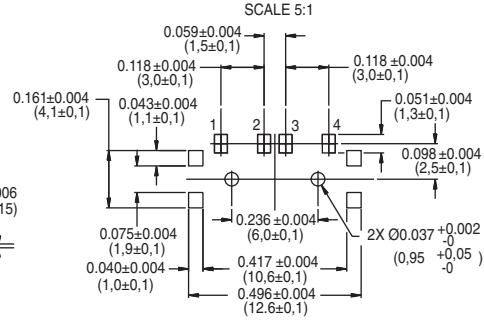

CARRIER TAPE

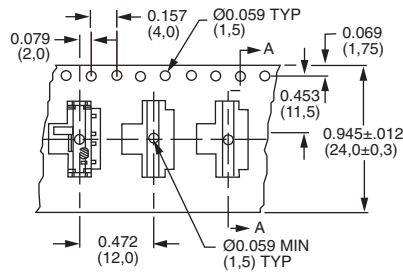

COVER TAPE

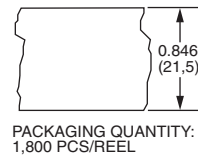

PACKAGING QUANTITY:
1,800 PCS/REEL

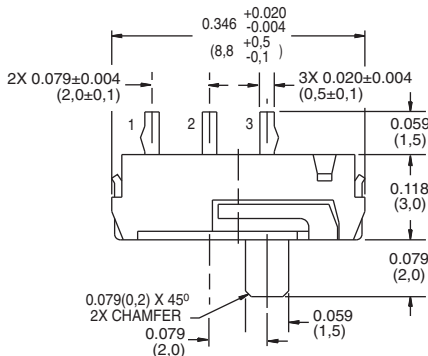

SCHEMATIC (1P2T)

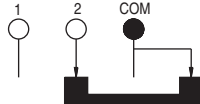

Shown in position 2



JSM08011SAQNR
SPDT Surface Mount
Momentary only

RECOMMENDED PC BOARD LAY OUT

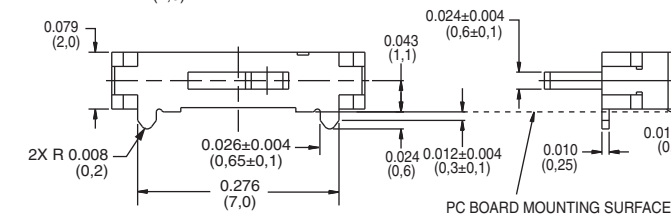
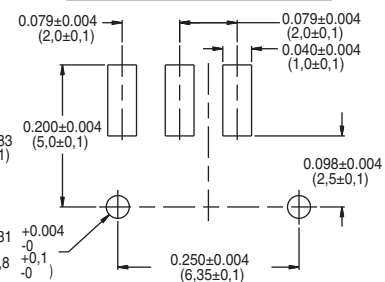

REEL

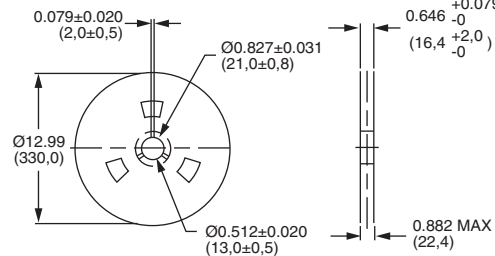

CARRIER TAPE

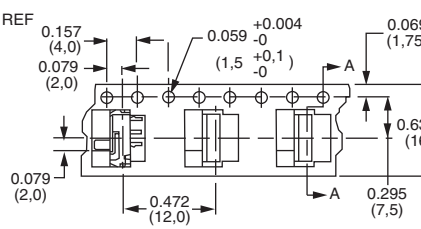

COVER TAPE



PACKAGING QUANTITY:
1,800 PCS/REEL



Third Angle Projection

Dimensions are shown: Inch (mm)
Specifications and dimensions subject to change



JSM Series Sub-Miniature Slide Switches

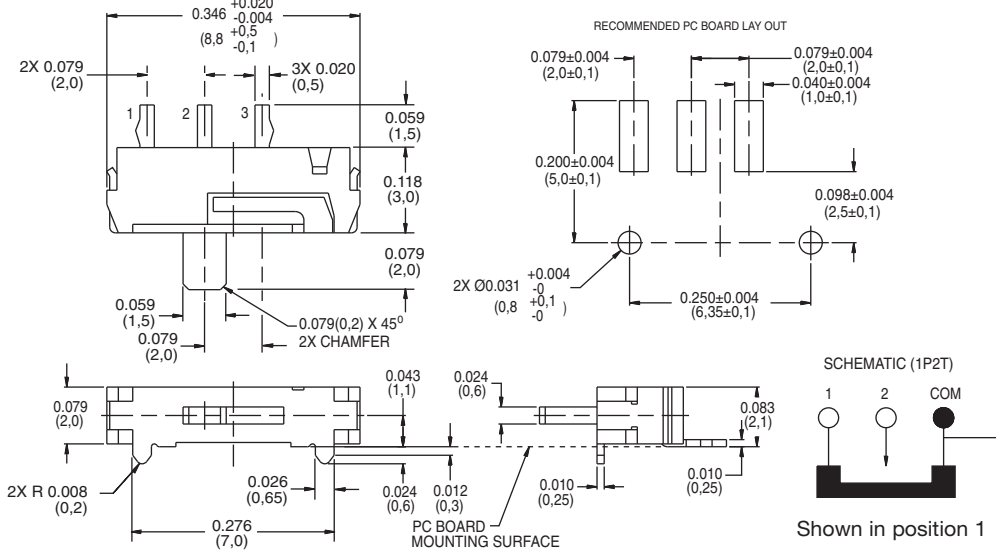

JSM08011SAQNL
SPDT Surface Mount
Momentary only

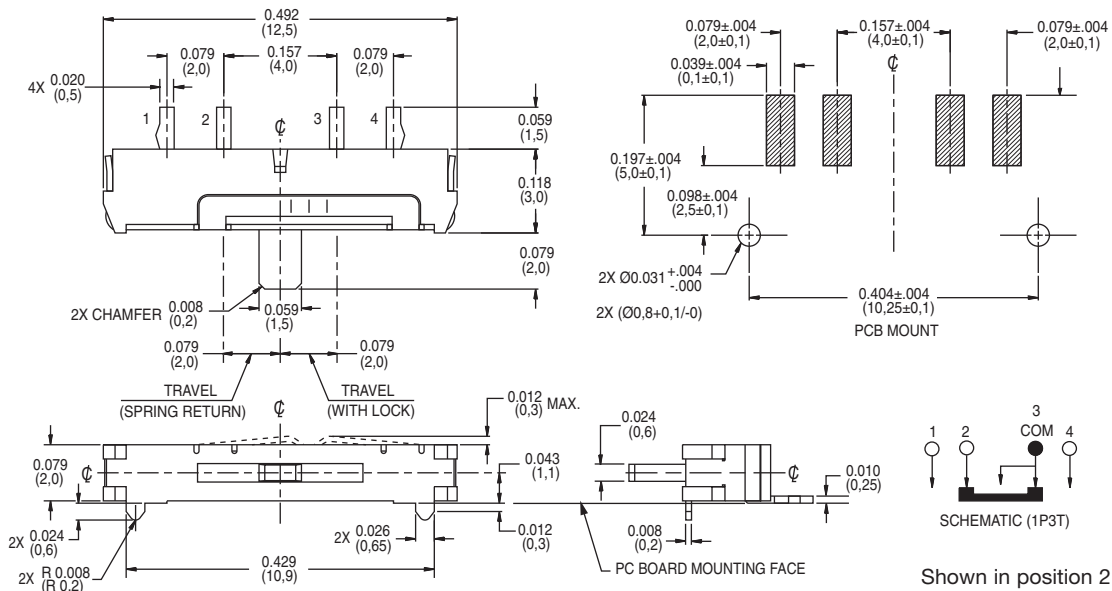
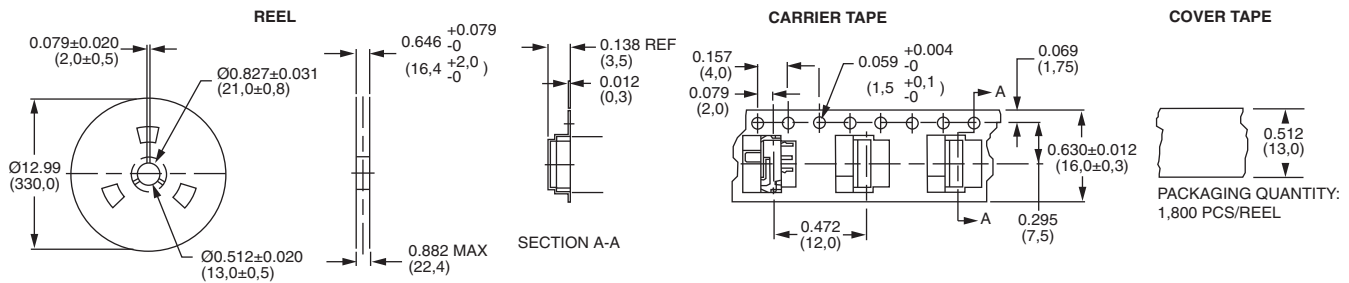
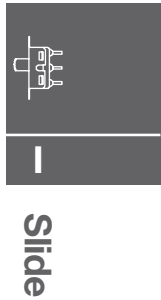

JSM07011SAQNR
SP3T Surface Mount
Momentary one side
& Maintained the other



Dimensions are shown: Inches (mm)
Specifications and dimensions subject to change

www.ck-components.com

JSM Series Sub-Miniature Slide Switches

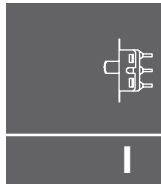

Slide

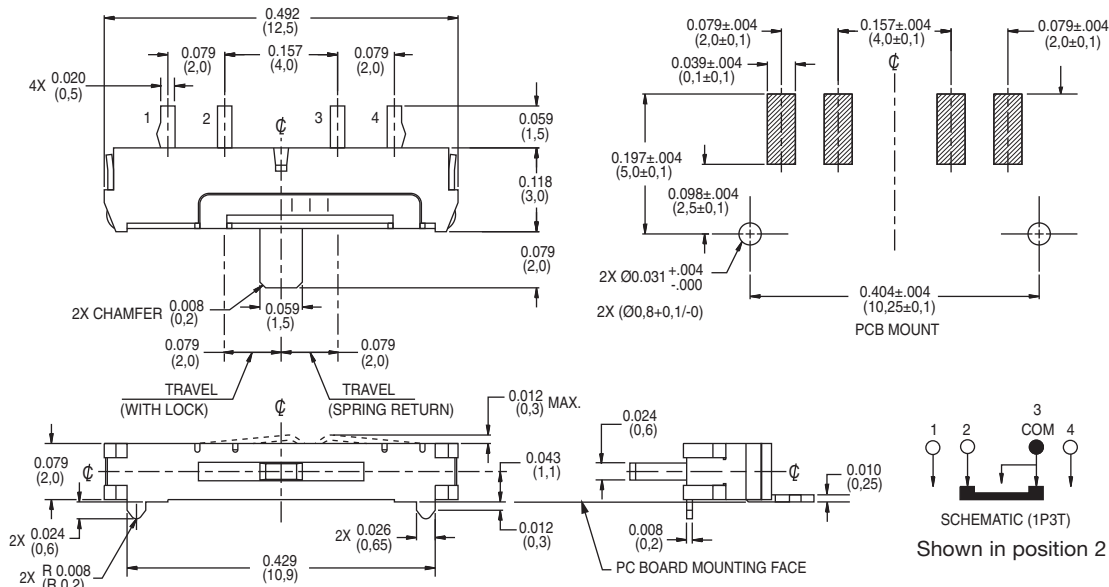

JSM07011SAQNL
SP3T Surface Mount
Momentary one side
& Maintained the other

Packaging for JSM07011SAQNR and JSM07011SAQNL

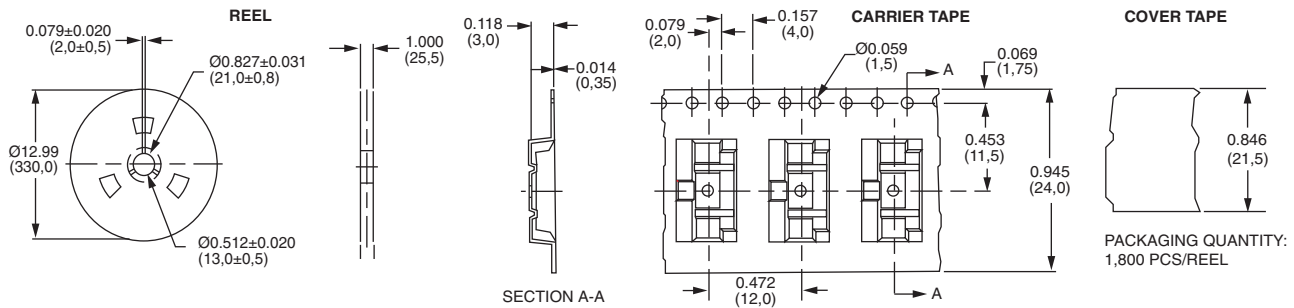

Dimensions are shown: Inch (mm)
Specifications and dimensions subject to change

JSM Series Sub-Miniature Slide Switches

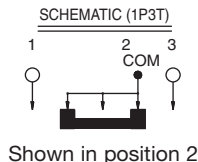
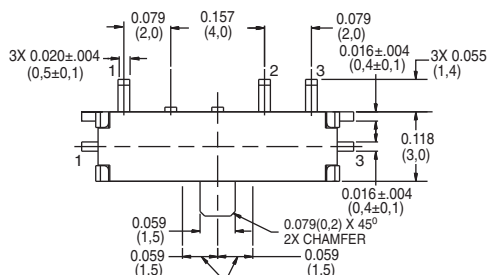

JSM05000SAQN
SP3T Surface Mount
Momentary both
sides

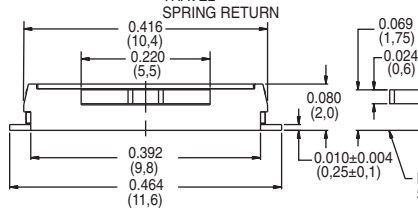

RECOMMENDED PC BOARD LAY OUT
SCALE 5:1

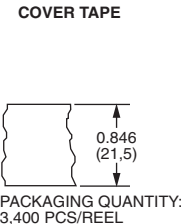
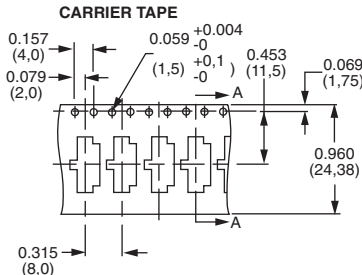
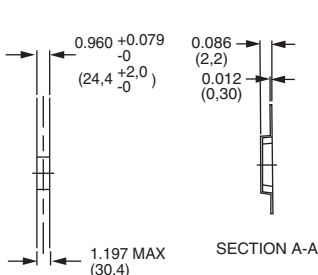
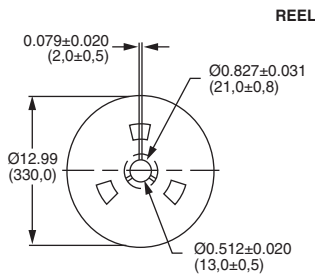
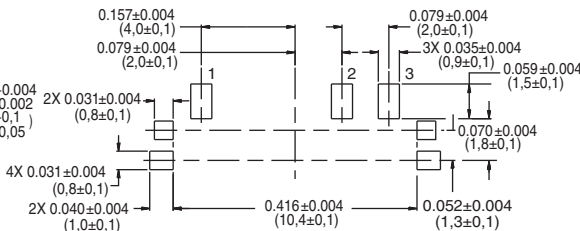

PACKAGING QUANTITY:
3,400 PCS/REEL



Dimensions are shown: Inches (mm)
Specifications and dimensions subject to change

单击下面可查看定价，库存，交付和生命周期等信息

[>>C&K](#)