

Features

- Wide Input Voltage Range: 3.6 V to 42 V
- Fixed Output: 1.2 V, 1.8 V, 2.5 V, 2.8 V, 3 V, 3.3 V, 4.5 V and 5V
- $\pm 1\%$ Output Accuracy Under Room Temperature
- Ultra-Low Quiescent Current: 2 μA
- Maximum Output Current: 200 mA
- Low Dropout Voltage: 200 mV at 50mA
- High PSRR: 73 dB at 100Hz
- Current Limit and Thermal Protection
- Stable with 2.2 μF or Higher Low ESR Ceramic Capacitor
- Soft-start Limits Input Current Surge During Enable
- Thermal Shutdown Protection
- Ambient Temperature Range: -40°C to $+85^{\circ}\text{C}$
- Junction Temperature Range: -40°C to $+125^{\circ}\text{C}$
- Packages: SOT89-3, SOT23-5, SOT23-3

Applications

- Handheld Devices with Battery Power Supply
- POS and Power Tools
- Meters and Smoke Detector
- Industrial control
- Wireless and IoT modules

Description

The TPL820 series products are high performance and low dropout linear regulators. The TPL820 series products support maximum 42 V input voltage and 200 mA output current with low quiescent current and high PSRR. The TPL820 series products is stable with 2.2 μF or higher output capacitor, and 4.7 μF ceramic capacitor is recommended.

The TPL820 series products have a high PSRR with 73 dB at 100 Hz. This feature makes TPL820 series products very suitable for power-sensitive applications with high noise from previous stage power supply. 2 μA ultra-low quiescent current makes the TPL820 series products ideal choices for portable devices with battery power supply. Current-limit and thermal overload protection circuits improves the reliability under heavy load conditions.

The TPL820 series products provide fixed output voltage options from 1.2 V to 5 V with $\pm 2\%$ voltage accuracy over operating conditions. The TPL820 series products are guaranteed over ambient temperature range from -40°C to $+85^{\circ}\text{C}$.

Typical Application Schematic

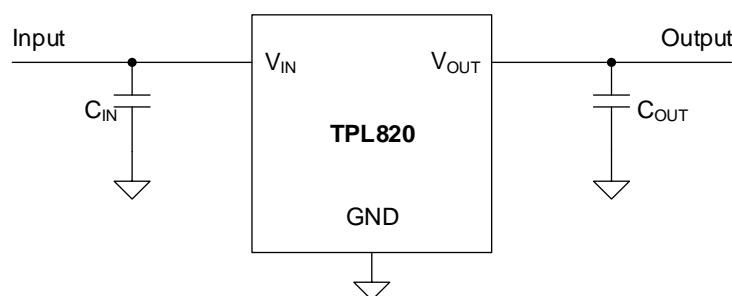

Product Family Table

Part Number	Output Voltage	Order Number	Package	Transport Media, Quantity	MSL	Marking Information
TPL820F12	Fixed 1.2 V	TPL820F12-89TR	SOT89-3	Tape and Reel, 4,000	L3	L5D
TPL820F18	Fixed 1.8 V	TPL820F18-89TR	SOT89-3	Tape and Reel, 4,000	L3	L5F
TPL820F25	Fixed 2.5 V	TPL820F25-89TR	SOT89-3	Tape and Reel, 4,000	L3	L5G
TPL820F28	Fixed 2.8 V	TPL820F28-89TR	SOT89-3	Tape and Reel, 4,000	L3	L5H
TPL820F30	Fixed 3.0 V	TPL820F30-89TR	SOT89-3	Tape and Reel, 4,000	L3	L5I
TPL820F33	Fixed 3.3 V	TPL820F33-89TR	SOT89-3	Tape and Reel, 4,000	L3	L5J
TPL820F45	Fixed 4.5 V	TPL820F45-89TR	SOT89-3	Tape and Reel, 4,000	L3	L5T
TPL820F50	Fixed 5.0 V	TPL820F50-89TR	SOT89-3	Tape and Reel, 4,000	L3	L5K
TPL820U12	Fixed 1.2 V	TPL820U12-89TR	SOT89-3 (B)	Tape and Reel, 4,000	L3	L5L
TPL820U18	Fixed 1.8 V	TPL820U18-89TR	SOT89-3 (B)	Tape and Reel, 4,000	L3	L5M
TPL820U25	Fixed 2.5 V	TPL820U25-89TR	SOT89-3 (B)	Tape and Reel, 4,000	L3	L5N
TPL820U28	Fixed 2.8 V	TPL820U28-89TR	SOT89-3 (B)	Tape and Reel, 4,000	L3	L5O
TPL820U30	Fixed 3.0 V	TPL820U30-89TR	SOT89-3 (B)	Tape and Reel, 4,000	L3	L5P
TPL820U33	Fixed 3.3 V	TPL820U33-89TR	SOT89-3 (B)	Tape and Reel, 4,000	L3	L5Q
TPL820U45	Fixed 4.5 V	TPL820U45-89TR	SOT89-3 (B)	Tape and Reel, 4,000	L3	L5S
TPL820U50	Fixed 5.0 V	TPL820U50-89TR	SOT89-3 (B)	Tape and Reel, 4,000	L3	L5R
TPL820F12	Fixed 1.2 V	TPL820F12-5TR	SOT23-5	Tape and Reel, 3,000	L3	L5D
TPL820F18	Fixed 1.8 V	TPL820F18-5TR	SOT23-5	Tape and Reel, 3,000	L3	L5F
TPL820F25	Fixed 2.5 V	TPL820F25-5TR	SOT23-5	Tape and Reel, 3,000	L3	L5G
TPL820F28	Fixed 2.8 V	TPL820F28-5TR	SOT23-5	Tape and Reel, 3,000	L3	L5H
TPL820F30	Fixed 3.0 V	TPL820F30-5TR	SOT23-5	Tape and Reel, 3,000	L3	L5I
TPL820F33	Fixed 3.3 V	TPL820F33-5TR	SOT23-5	Tape and Reel, 3,000	L3	L5J
TPL820F45	Fixed 4.5 V	TPL820F45-5TR	SOT23-5	Tape and Reel, 3,000	L3	L5T
TPL820F50	Fixed 5.0 V	TPL820F50-5TR	SOT23-5	Tape and Reel, 3,000	L3	L5K
TPL820U12	Fixed 1.2 V	TPL820U12-5TR	SOT23-5 (B)	Tape and Reel, 3,000	L3	L5L
TPL820U18	Fixed 1.8 V	TPL820U18-5TR	SOT23-5 (B)	Tape and Reel, 3,000	L3	L5M
TPL820U25	Fixed 2.5 V	TPL820U25-5TR	SOT23-5 (B)	Tape and Reel, 3,000	L3	L5N
TPL820U28	Fixed 2.8 V	TPL820U28-5TR	SOT23-5 (B)	Tape and Reel, 3,000	L3	L5O
TPL820U30	Fixed 3.0 V	TPL820U30-5TR	SOT23-5 (B)	Tape and Reel, 3,000	L3	L5P
TPL820U33	Fixed 3.3 V	TPL820U33-5TR	SOT23-5 (B)	Tape and Reel, 3,000	L3	L5Q
TPL820U45	Fixed 4.5 V	TPL820U45-5TR	SOT23-5 (B)	Tape and Reel, 3,000	L3	L5S
TPL820U50	Fixed 5.0 V	TPL820U50-5TR	SOT23-5 (B)	Tape and Reel, 3,000	L3	L5R

Product Family Table (continued)

Part Number	Output Voltage	Order Number	Package	Transport Media, Quantity	MSL	Marking Information
TPL820F12	Fixed 1.2 V	TPL820F12- 3TR	SOT23-3	Tape and Reel, 3,000	L3	L5D
TPL820F18	Fixed 1.8 V	TPL820F18- 3TR	SOT23-3	Tape and Reel, 3,000	L3	L5F
TPL820F25	Fixed 2.5 V	TPL820F25- 3TR	SOT23-3	Tape and Reel, 3,000	L3	L5G
TPL820F28	Fixed 2.8 V	TPL820F28- 3TR	SOT23-3	Tape and Reel, 3,000	L3	L5H
TPL820F30	Fixed 3.0 V	TPL820F30- 3TR	SOT23-3	Tape and Reel, 3,000	L3	L5I
TPL820F33	Fixed 3.3 V	TPL820F33- 3TR	SOT23-3	Tape and Reel, 3,000	L3	L5J
TPL820F45	Fixed 4.5 V	TPL820F45- 3TR	SOT23-3	Tape and Reel, 3,000	L3	L5T
TPL820F50	Fixed 5.0 V	TPL820F50- 3TR	SOT23-3	Tape and Reel, 3,000	L3	L5K

Table of Contents

Features	1
Applications	1
Description	1
Typical Application Schematic	1
Product Family Table	2
Table of Contents	4
Revision History	5
Pin Configuration and Functions	6
Specifications	7
Absolute Maximum Ratings	7
ESD, Electrostatic Discharge Protection	7
Recommended Operating Conditions	7
Thermal Information	7
Electrical Characteristics	8
Typical Performance Characteristics	9
Detailed Description	11
Overview	11
Functional Block Diagram	11
Feature Description	11
Application and Implementation	12
Application Information	12
Typical Application	12
Layout Requirements	13
Package Outline Dimensions	14
SOT89-3	14
SOT23-5	15
SOT23-3	16

Revision History

Date	Revision	Notes
2018/9/28	Rev.Pre	Preliminary Version
2018/11/27	Rev.A.0	Initial Release

Pin Configuration and Functions

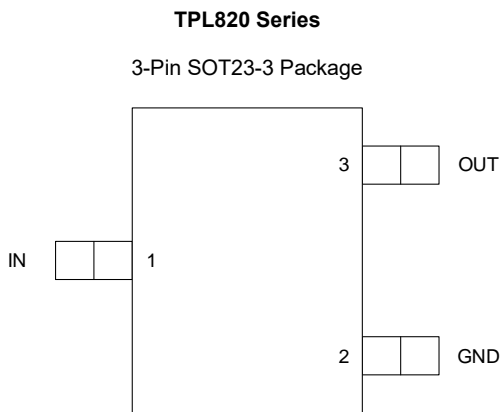
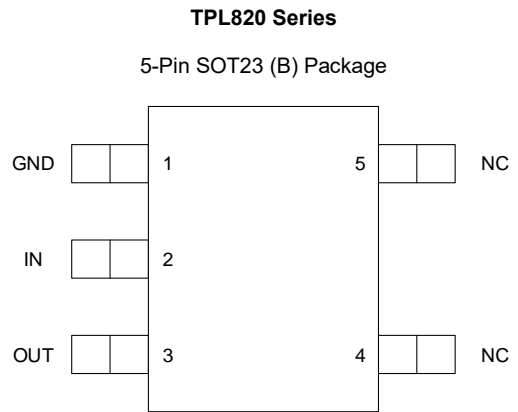
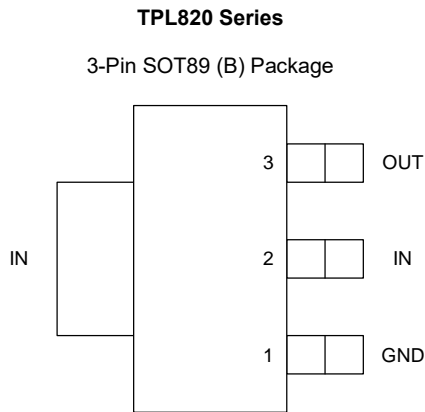
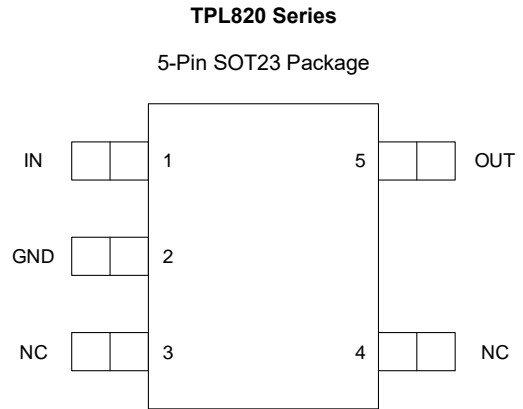
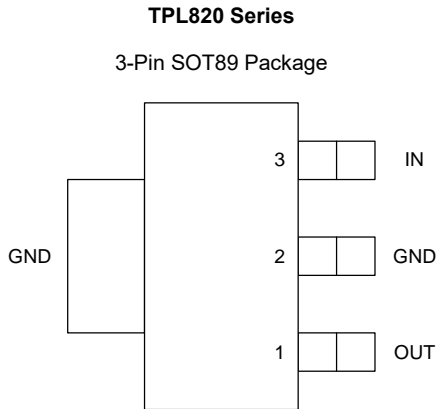

Pin Functions

Name	Pin Number					I/O	Description
	SOT89-3	SOT89-3 (B)	SOT23-5	SOT23-5 (B)	SOT23-3		
IN	3	2	1	2	1	I	Input voltage pin.
NC	-	-	3, 4	4, 5	-	-	No connection
OUT	1	3	5	3	3	O	Regulated output voltage pin.
GND	2	1	2	1	2	-	Ground reference pin. Connect GND pin to PCB ground plane directly.

Note: Thermal pad must be connected to PCB ground plane to maximum the thermal performance.

Specifications

Absolute Maximum Ratings

Parameters		Min	Max	Unit
V _{IN}	Maximum Input Voltage	-0.3	45	V
V _{OUT}	Maximum Output Voltage	-0.3	6	V
P _D	Maximum Operating Power Dissipation		1.5	W
T _J	Junction Temperature Range	-40	150	°C
T _{STG}	Storage Temperature Range	-65	150	°C
T _L	Lead Temperature (Soldering 10 sec)		260	°C

(1) Stresses beyond those listed under Absolute Maximum Ratings may cause permanent damage to the device. Exposure to any Absolute Maximum Rating condition for extended periods may affect device reliability and lifetime.

(2) All voltage values are with respect to GND.

ESD, Electrostatic Discharge Protection

Symbol	Parameter	Condition	Minimum Level	Unit
HBM	Human Body Model ESD	ANSI/ESDA/JEDEC JS-001	±2.5	kV
CDM	Charged Device Model ESD	ANSI/ESDA/JEDEC JS-002	±2	kV

Recommended Operating Conditions

Parameters		Min	Max	Unit
V _{IN}	Input Voltage	3.6	42	V
V _{OUT}	Output Voltage	1.2	5	V
I _{OUT}	Output Current	0	200	mA
T _J	Operating Junction Temperature Range	-40	125	°C
T _A	Operating Ambient Temperature Range	-40	85	°C
P _D	Power Dissipation (SOT89-3 Package)	0	1000	mW
	Power Dissipation (SOT23-5 Package)	0	300	mW
	Power Dissipation (SOT23-3 Package)	0	300	mW

Thermal Information

Package Type	θ _{JA}	θ _{JC}	Unit
SOT89-3	55	88	°C/W
SOT23-5	280	62	°C/W
SOT23-3	280	62	°C/W

Electrical Characteristics

All test condition: $V_{IN} = V_{OUT(NOM)} + 1V$ or $3.6V$, whichever is greater; $C_{OUT} = 2.2\mu F$, $T_A = +25^\circ C$, unless otherwise noted.

Symbol	Parameter	Conditions	Min	Typ	Max	Unit
Supply Input Voltage and Current						
V_{IN}	Input voltage range		3.6		42	V
I_{GND}	Ground pin current	$I_{OUT} = 0\text{ mA}$		2	5	μA
		$I_{OUT} = 200\text{ mA}$		400		μA
UVLO	V_{IN} under-voltage lock-out	V_{IN} rising		2.9		V
Regulated Output Voltage and Current						
V_{OUT}	Output voltage accuracy	$T_J = +25^\circ C$		1%		
		$-40^\circ C \leq T_J \leq +125^\circ C$	-2%		2%	
ΔV_{OUT}	Line regulation	$V_{IN} = V_{OUT(NOM)} + 1V$ to $42V$, or $V_{IN} \geq 3.6V$, $I_{OUT} = 1\text{ mA}$		3		mV
	Load regulation	$I_{OUT} = 1\text{ mA}$ to 200 mA		20		mV
$V_{DO}^{(1)}$	Dropout voltage	$V_{IN} = 0.98 \times V_{OUT(NOM)}$, $I_{OUT} = 50\text{ mA}$		200	600	mV
		$V_{IN} = 0.98 \times V_{OUT(NOM)}$, $I_{OUT} = 200\text{ mA}$		800		mV
I_{OUT}	Output current	V_{OUT} in regulation	0		200	mA
$I_{CL}^{(2)}$	Output current limit	$V_{OUT} = 0.9 \times V_{OUT(NOM)}$	250		800	mA
PSRR	Power supply rejection ratio	$I_{OUT} = 10\text{ mA}$, $f = 100\text{ Hz}$, $C_{OUT} = 4.7\mu F$		75		dB
		$I_{OUT} = 10\text{ mA}$, $f = 1\text{ kHz}$, $C_{OUT} = 4.7\mu F$		65		dB
		$I_{OUT} = 10\text{ mA}$, $f = 10\text{ kHz}$, $C_{OUT} = 4.7\mu F$		65		dB
V_N	Output noise voltage	$I_{OUT} = 10\text{ mA}$, $BW = 10\text{ Hz}$ to 100 kHz		110		μV_{RMS}
		$I_{OUT} = 10\text{ mA}$, $BW = 100\text{ Hz}$ to 100 kHz		70		μV_{RMS}
Temperature Range						
T_{SD}	Thermal shutdown temperature			160		$^\circ C$
	Thermal shutdown hysteresis			40		$^\circ C$

(1). Dropout voltage is the minimum input to output voltage differential needed to maintain regulation at a specified output current. In dropout, the output voltage will be equal to: $V_{IN} - V_{DROPOUT}$.

(2). Measured with $V_{IN} = V_{OUT} + 3V$ for $V_{OUT(NOM)} \leq 2.5V$. Measured with $V_{IN} = V_{OUT} + 2.5V$ for $V_{OUT(NOM)} > 2.5V$.

Typical Performance Characteristics

All test condition: $V_{IN} = V_{OUT(NOM)} + 1\text{ V}$ or 3.6 V , whichever is greater; $C_{OUT} = 2.2\ \mu\text{F}$, $T_A = +25^\circ\text{C}$, unless otherwise noted.

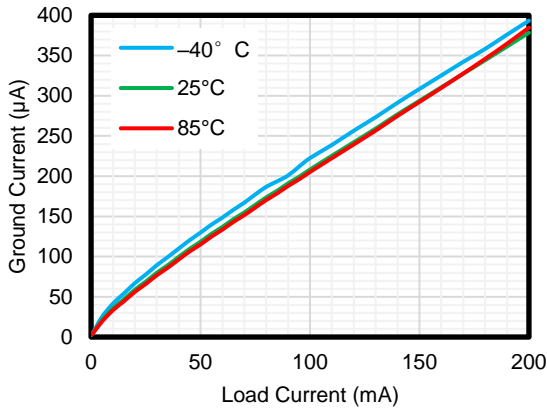

Figure 1 Quiescent Current vs Output Current

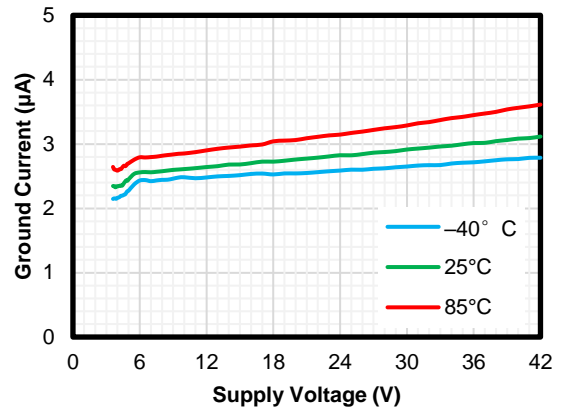
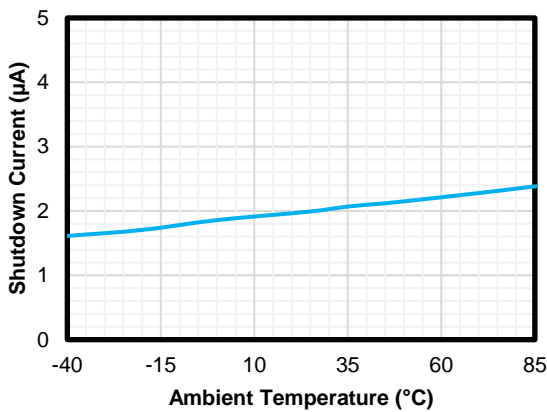

Figure 2 Quiescent Current vs Input Voltage



$V_{IN} = 12\text{V}$

Figure 3 Shutdown Current vs Ambient Temperature

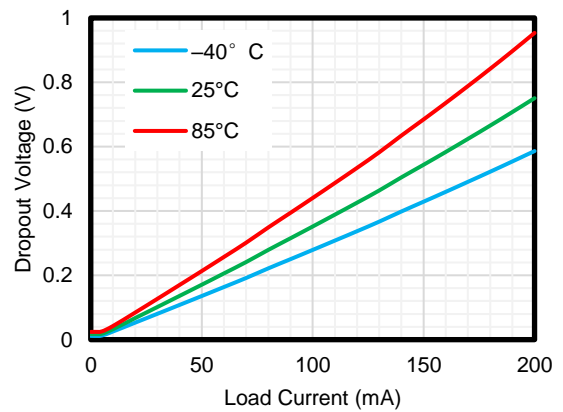
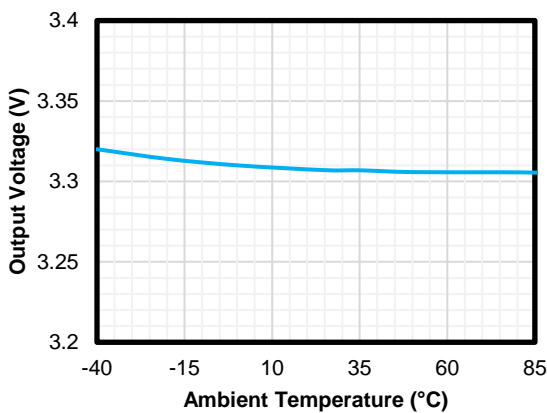

Figure 4 Dropout Voltage vs Output Current



$I_{OUT} = 0\text{ mA}$

Figure 5 Output Accuracy vs Ambient Temperature

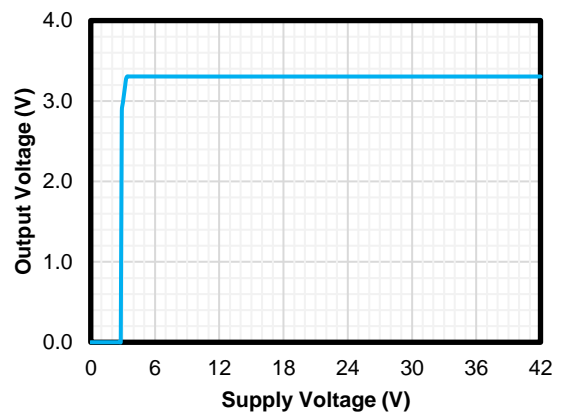
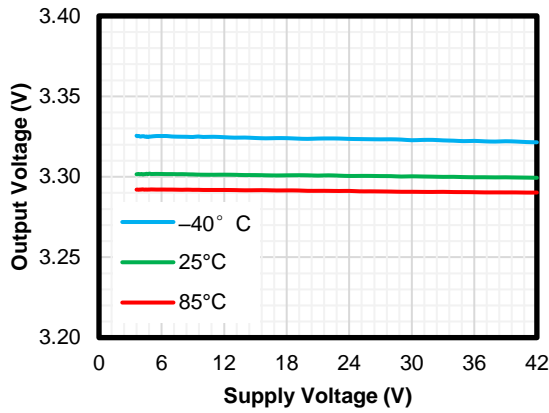

Figure 6 Output Voltage vs Input Voltage

Typical Performance Characteristics (continued)

All test condition: $V_{IN} = V_{OUT(NOM)} + 1\text{ V}$ or 3.6 V , whichever is greater; $C_{OUT} = 2.2\text{ }\mu\text{F}$, $T_A = +25^\circ\text{C}$, unless otherwise noted.



$I_{OUT} = 1\text{ mA}$

Figure 7. Line Regulation

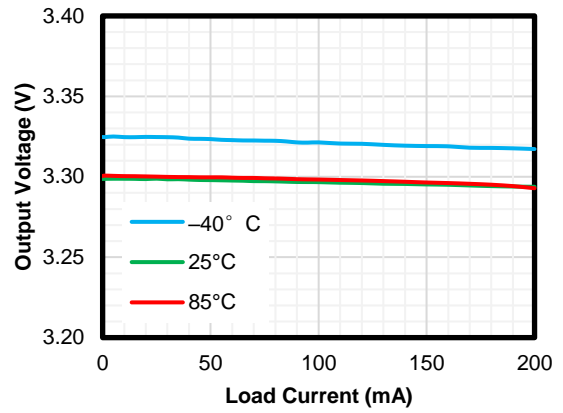

Figure 8. Load Regulation

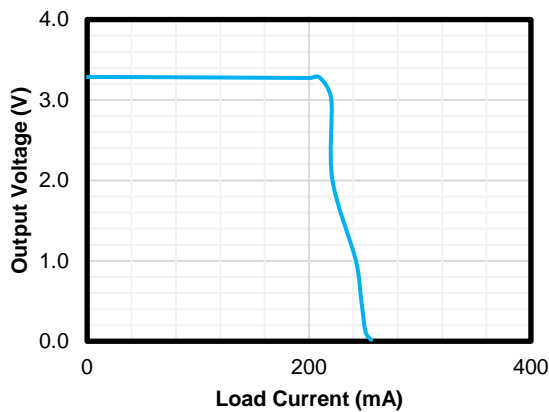
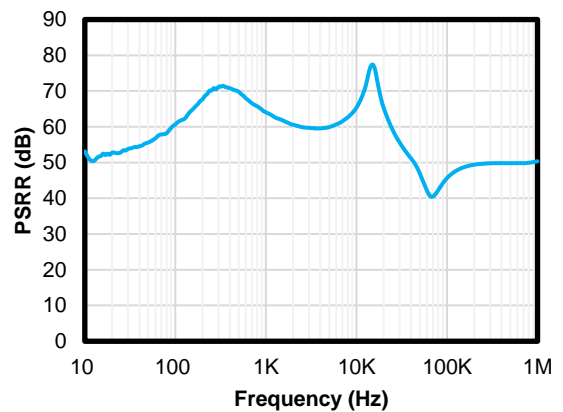

Figure 9. Current Limit



$I_{OUT} = 100\text{ mA}$

Figure 10. PSRR

Detailed Description

Overview

The TPL820 series products are 200mA wide input range linear regulators with very low quiescent current. These voltage regulators operate from 3.6 V to 42 V and consume 2 μ A of quiescent current at no load.

The TPL820 series products are available in fixed voltage versions of 1.2 V, 1.8 V, 2.5 V, 2.8 V, 3 V, 3.3 V, 4.5 V and 5V with $\pm 2\%$ output voltage accuracy over operating conditions.

Functional Block Diagram

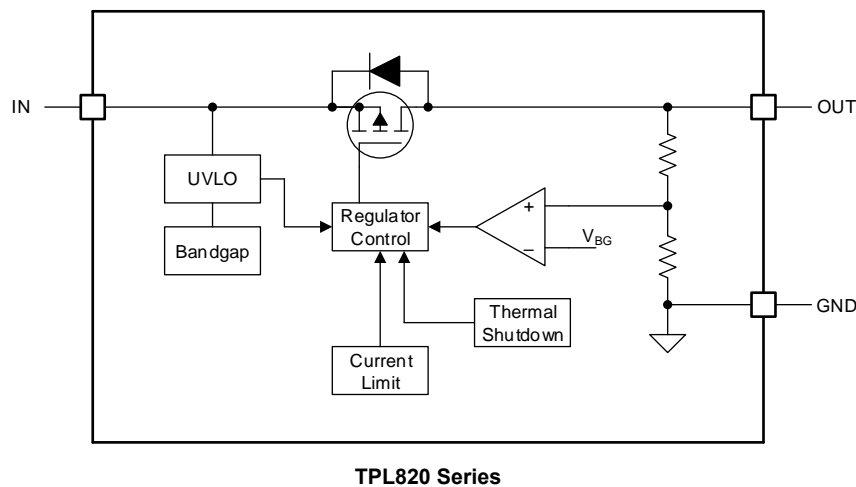

Feature Description

Under-voltage Lockout (UVLO)

The TPL820 series use an under-voltage lockout circuit (UVLO = 2.9 V) to keep the output shut off until the internal circuitry operates properly.

Regulated Output Voltage

The TPL820 series are available in fixed voltage versions of 1.2 V, 1.8 V, 2.5 V, 2.8 V, 3 V, 3.3 V, 4.5 V and 5V. When the input voltage is higher than $V_{OUT(NOM)} + V_{DO}$ or 3.6V, output pin is the regulated output based on the selected voltage version. When the input voltage falls below $V_{OUT(NOM)} + V_{DO}$ or 3.6V, output pin tracks the input voltage minus the dropout voltage based on the load current. When the input voltage drops below UVLO threshold, the output keeps shut off.

Current Limit

The TPL820 series integrate an internal current limit that helps to protect the regulator during fault conditions. Output voltage is not regulated when the device is in current limit, and is $V_{OUT} = I_{CL} \times R_{LOAD}$.

Thermal Shutdown

During normal operation, LDO junction temperature should not exceed 125°C. When the junction temperature exceeds the thermal shutdown threshold, the LDO shut down the output immediately. Until when the junction temperature falls below the thermal shutdown threshold minus thermal shutdown hysteresis, the output turns on again.

Application and Implementation

NOTE

Information in the following applications sections is not part of the 3PEAK's component specification and 3PEAK does not warrant its accuracy or completeness. 3PEAK's customers are responsible for determining suitability of components for their purposes. Customers should validate and test their design implementation to confirm system functionality.

Application Information

The TPL820 series products are 42V 200mA wide input range linear regulators with very low quiescent current. The following application schematic shows a typical usage of the TPL820 series.

Typical Application

Figure 11 show the typical application schematic of the TPL820 series.

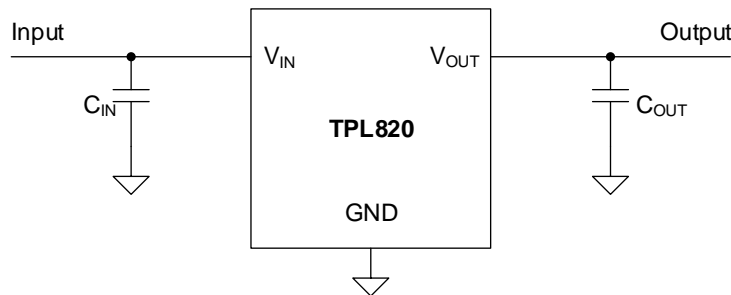

Figure 11 TPL820 Typical Application

Input Capacitor and Output Capacitor

3PEAK recommends adding a 2.2 μF or greater capacitor with a 0.1 μF bypass capacitor in parallel at IN pin to keep the input voltage stable. Aluminum electrolytic capacitor or other capacitor with high capacitance is suggested for the system power with large voltage spike. The voltage rating of the capacitors must be greater than the maximum input voltage.

To ensure loop stability, the TPL820 series requires an output capacitor with a minimum effective capacitance value of 2.2 μF . 3PEAK recommends selecting a X5R- or X7R-type 4.7 μF ceramic capacitor with low ESR over temperature range.

Both input capacitors and output capacitors must be placed as close to the device pins as possible.

Power Dissipation

During normal operation, LDO junction temperature should not exceed 125°C. Using below equations to calculate the power dissipation and estimate the junction temperature.

The power dissipation can be calculated using Equation 1.

$$P_D = (V_{IN} - V_{OUT}) \times I_{OUT} + V_{IN} \times I_{GND} \quad (1)$$

The junction temperature can be estimated using Equation 2. θ_{JA} is the junction-to-ambient thermal resistance (See Section [Thermal Information](#)).

$$T_J = T_A + P_D \times \theta_{JA} \quad (2)$$

Layout Requirements

- Both input capacitors and output capacitors must be placed as close to the device pins as possible.
- It is recommended to bypass the input pin to ground with a 0.1 μ F bypass capacitor. The loop area formed by the bypass capacitor connection, IN pin and the GND pin of the system must be as small as possible.
- It is recommended to use wide trace lengths or thick copper weight to minimize $I \times R$ drop and heat dissipation.

Package Outline Dimensions

SOT89-3

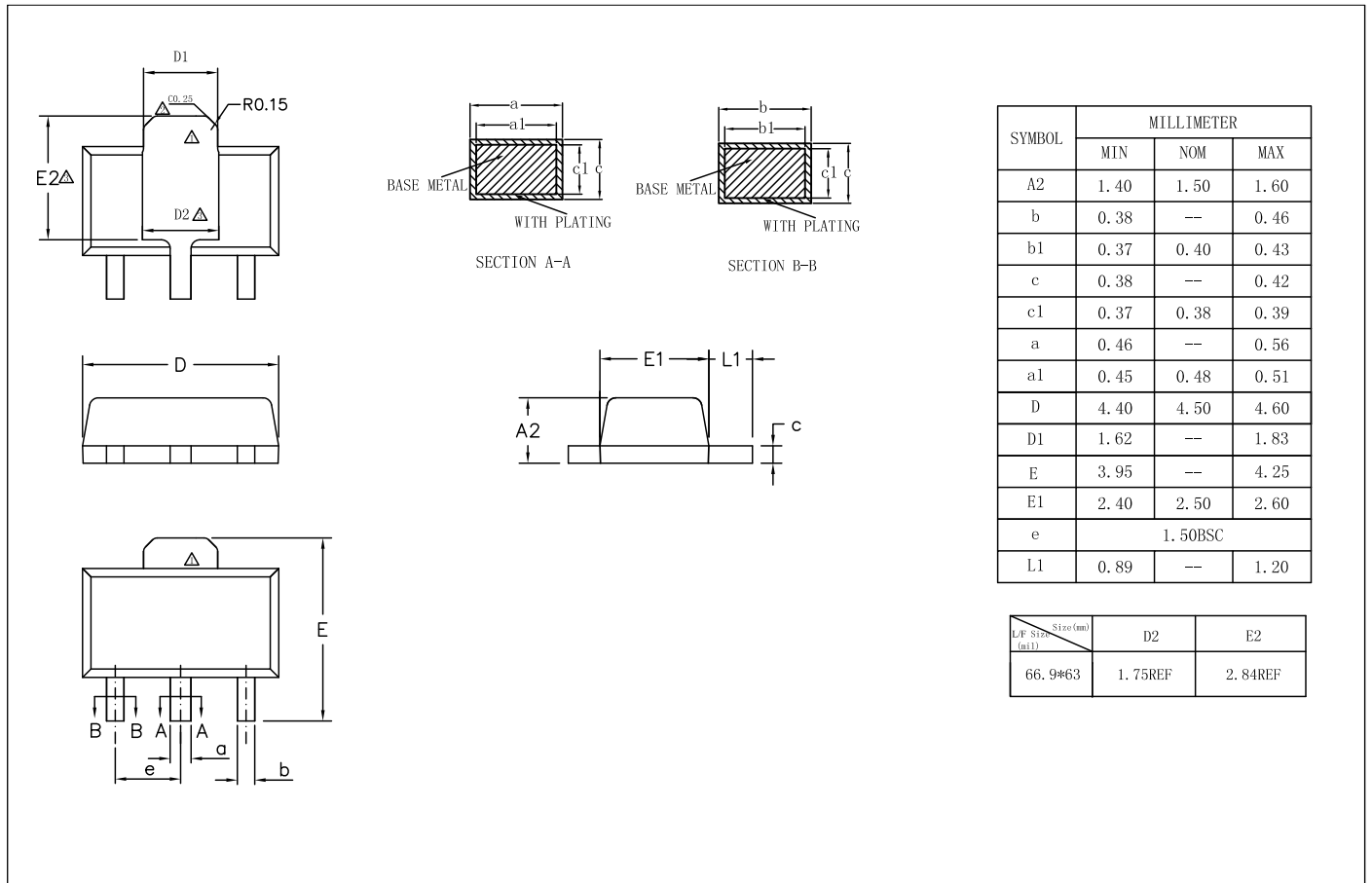

SOT23-5

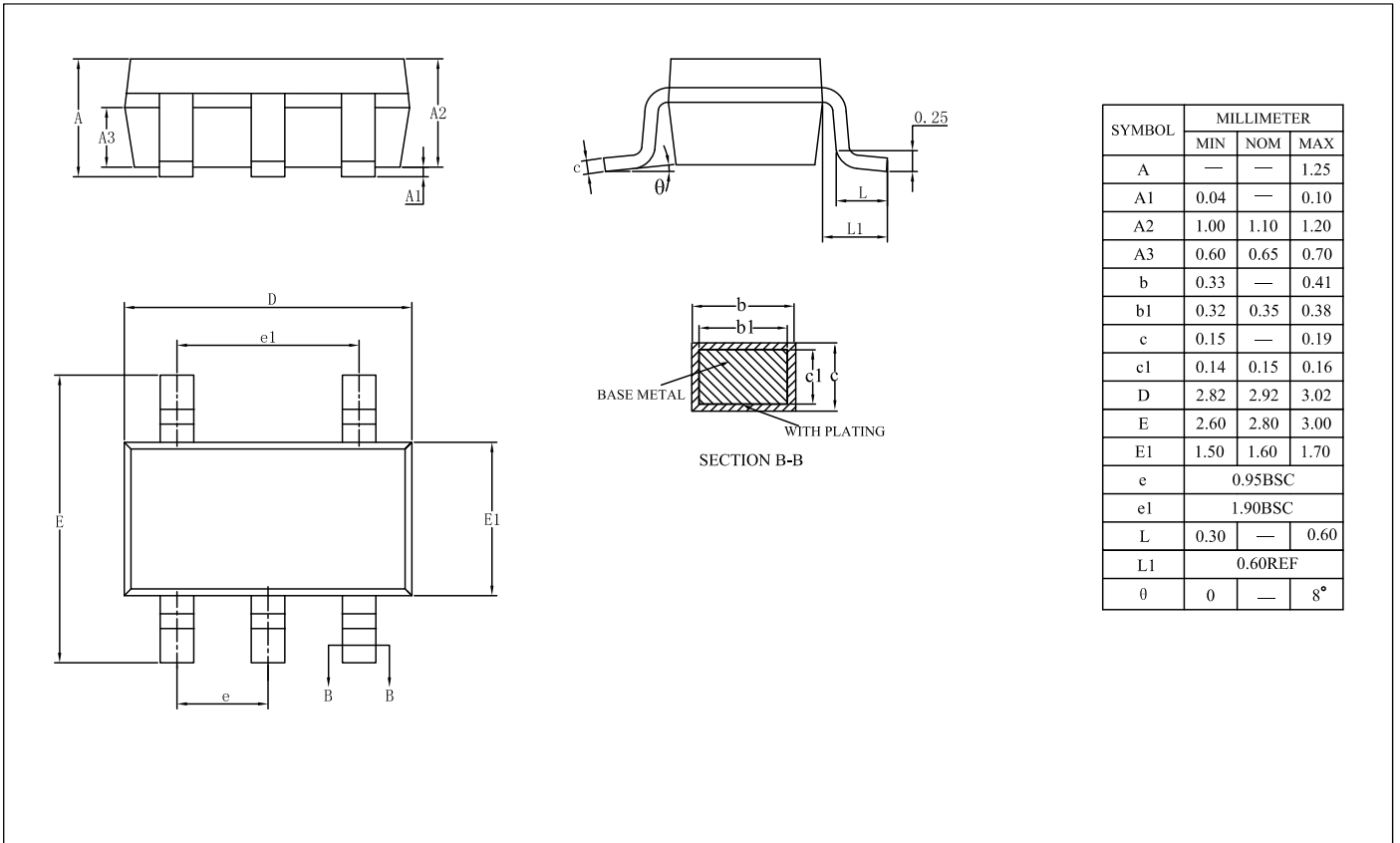

SOT23-3

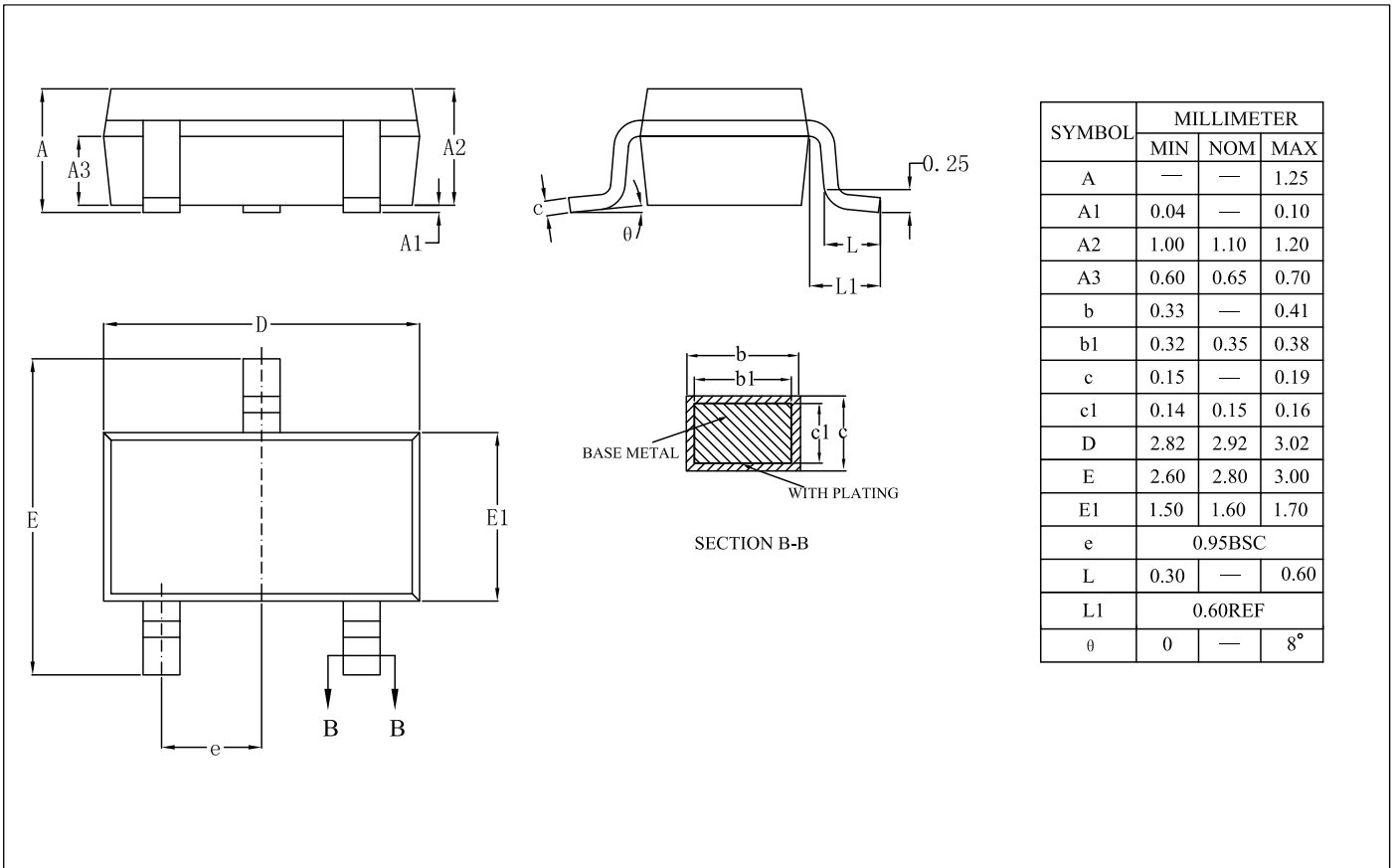

3PEAK and the 3PEAK logo are registered trademarks of 3PEAK INCORPORATED. All other trademarks are the property of their respective owners.

单击下面可查看定价，库存，交付和生命周期等信息

[>>3PEAK\(思瑞浦\)](#)