

Features

- 17-V H-bridge Driver
- MOSFET On-resistance $R_{ds(on)}$ HS + LS 0.85 Ω
- 1-A Max Output Current
- Supports 2.5-V to 17-V Operating Supply Voltage
- Supports 1.8-V, 3.3-V, 5-V Logic Voltage
- PWM (IN1/IN2) interface
- Protection
 - Undervoltage Lockout Protection (UVLO)
 - Over-Current Protection (OCP)
 - Thermal Shutdown (TSD)
- Small Package Footprint
 - DFN-8 Package

Description

The TPM8837C is a high-voltage H-bridge driver. It is designed to control inductive loads such as DC motors, solenoids and relays. It can provide up-to 1-A drive current with maximum 17-V power supply.

The TPM8837C features a solution for motors used widely in consumer products, toys and other low-to-mid voltage or battery-powered motion control applications. The output driver is an H-bridge with VM voltage ranges from 2.5 V to 17 V. Control logic can operate on 1.8-V, 3.3-V and 5-V rails.

Internal protection features such as overcurrent protection, short circuit protection undervoltage lockout and over temperature improve reliability of the whole system.

Applications

- Surveillance Cameras
- E-Lock
- Consumer devices
- Toys

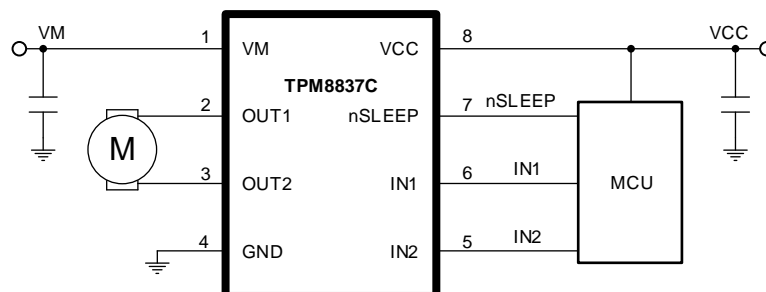

Typical Application Diagram

Table of Contents

Features	1
Applications	1
Description	1
Table of Contents	2
Order Information	3
Pin Configuration and Functions	3
Pin Functions	3
Absolute Maximum Ratings ^{Note 1}	4
ESD Rating	4
Thermal Information	4
Electrical Characteristics	5
Typical Performance Characteristics	6
Detailed Description	8
Overview	8
Functional Block Diagram	9
Feature Description	9
Tape and Reel Information	11
Package Outline Dimensions	12

Revision History

Date	Revision	Notes
2019/12/24	Rev 1.0	Miscellaneous update

Order Information

Order Number	Operating Ambient Temperature Range	Package	Marking Information	MSL	Transport Media, Quantity
TPM8837C-DF4R	-40 °C – 125 °C ⁽¹⁾	DFN2X2-8L	837	MSL3	3000
TPM8837C-SO1R	-40 °C – 125 °C ⁽¹⁾	SOP8	837	MSL3	4000

(1) Ambient temperature indicates device operation condition range. Application thermal behavior needs to be taken care of when operating in high temperature scenarios.

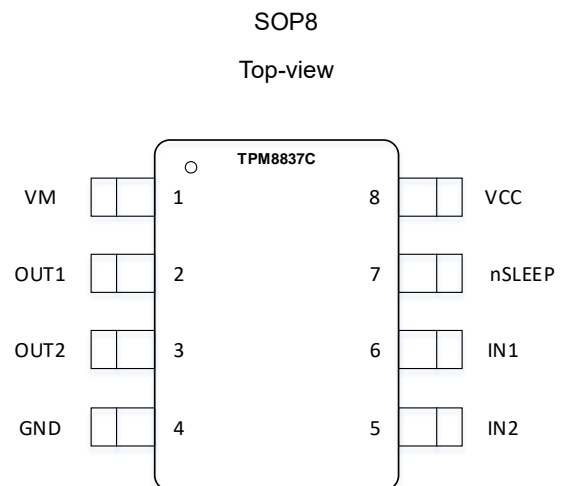
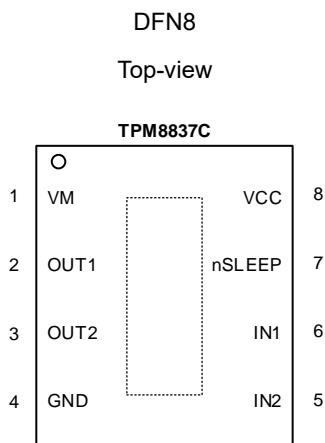
Pin Configuration and Functions

Pin Functions

Pin	I/O	Description
GND	4	Ground Device ground
IN1	6	Input Bridge input 1
IN2	5	Input Bridge input 2
nSLEEP	7	Input Device enable, active high
OUT1	2	Output H-Bridge output 1
OUT2	3	Output H-Bridge output 2
VCC	8	I/O Power Device power supply
VM	1	Motor Power Motor power supply

Absolute Maximum Ratings ^{Note 1}

Parameters	Rating
Motor Power Supply voltage, VM	-0.3 V to 18 V
Device Power Supply voltage, VCC	-0.3 V to 6 V
Outputs, OUT1, OUT2	-0.3V to 18 V
Digital Input Voltage, IN1, IN2	-0.3V to 6 V
Peak output current	Internally limited
Continuous motor drive output current	1 A
Output Short-Circuit Duration ^{Note 3}	Infinite
Maximum Junction Temperature	150°C
Operating Junction Temperature Range	-40 to 150°C
Storage Temperature Range	-65 to 150°C
Lead Temperature (Soldering, 10 sec)	260°C

Note 1: Stresses beyond those listed under Absolute Maximum Ratings may cause permanent damage to the device. Exposure to any Absolute Maximum Rating condition for extended periods may affect device reliability and lifetime.

Note 2: The inputs are protected by ESD protection diodes to each power supply. If the input extends more than 300mV beyond the power supply, the input current should be limited to less than 10mA.

Note 3: A heat sink may be required to keep the junction temperature below the absolute maximum. This depends on the power supply voltage and how many amplifiers are shorted. Thermal resistance varies with the amount of PC board metal connected to the package. The specified values are for short traces connected to the leads.

Note 4: Power dissipation and thermal limits must be observed.

ESD Rating

Symbol	Parameter	Condition	Minimum Level	Unit
HBM	Human Body Model ESD	ANSI/ESDA/JEDEC JS-001	±2	kV
CDM	Charged Device Model ESD	ANSI/ESDA/JEDEC JS-002	±1	kV

Thermal Information

Package Type	θ_{JA}	θ_{JC}	Unit
DFN2X2-8L	103	55	°C/W

Electrical Characteristics

All test condition is $V_M = 5\text{ V}$, $T_A = -40\text{ }^\circ\text{C} - 125\text{ }^\circ\text{C}$, unless otherwise noted.

Symbol	Parameter	Conditions	Min	Typ	Max	Unit
Power Supply						
V_M	V_M operating voltage		2.5		17	V
I_{VM}	V_M operating supply current	$V_M = 5\text{ V}$; $V_{CC} = 3\text{ V}$; IN1/IN2 low; nSLEEP = 5 V		340	500	μA
I_{VMQ}	V_M quiescent supply current	$V_M = 5\text{ V}$; $V_{CC} = 3\text{ V}$; IN1/IN2 low; nSLEEP = 0 V		0.01	0.5	μA
V_{UVLO}	V_{CC} under voltage lockout	V_{CC} rising	1.5	1.62	1.71	V
		V_{CC} falling	1.45	1.55	1.65	
V_{CC}	V_{CC} operating voltage		1.8		5.5	V
I_{VCC}	V_{CC} operating supply current	$V_M = 5\text{ V}$; $V_{CC} = 3\text{ V}$; IN1/IN2 low; nSLEEP = 5 V		135	250	μA
I_{VCCQ}	V_{CC} quiescent supply current	$V_M = 5\text{ V}$; $V_{CC} = 3\text{ V}$; IN1/IN2 low; nSLEEP = 0		0.01	0.5	μA
Input Characteristics						
V_{IL}	Input low voltage				$0.25 \times V_{CC}$	V
V_{IH}	Input high voltage		$0.5 \times V_{CC}$			V
I_{IL}	Input low current	$V_{IN} = 0\text{ V}$	-5		5	μA
I_{IH}	Input high current	$V_{IN} = 3.3\text{ V}$			50	μA
R_{PD}	Pull-down resistance			100		k Ω
H-Bridge FETs						
$R_{DS(ON)}$	HS+LS FET ON resistance	$V_M = 12\text{ V}$, $I_O = 250\text{ mA}$, $T_J = 25\text{ }^\circ\text{C}$		0.85		Ω
		$V_M = 5\text{ V}$, $I_O = 250\text{ mA}$, $T_J = 25\text{ }^\circ\text{C}$		0.85		
I_{OFF}	OFF-state leakage current			10		μA
Protection Circuits						
I_{OCP}	Overcurrent protection trip level		1.2	1.6	2	A
t_{DEG}	Overcurrent deglitch time			1		μs
t_{OCR}	Overcurrent protection retry time			1		ms
t_{DEAD}	Output dead time			100		ns
T_{SD}	Thermal shutdown temperature	Junction temperature	150	160	180	$^\circ\text{C}$
Timing						
t_7	Output enable time	$R_L = 20\text{ }\Omega$			300	ns
t_8	Output disable time	$R_L = 20\text{ }\Omega$			300	ns
t_9	Delay time, INx high to OUTx high	$R_L = 20\text{ }\Omega$			160	ns
t_{10}	Delay time, INx low to OUTx low	$R_L = 20\text{ }\Omega$			160	ns
t_R	Output rise time	$R_L = 20\text{ }\Omega$	30		188	ns

Symbol	Parameter	Conditions	Min	Typ	Max	Unit
t_F	Output fall time	$R_L = 20 \Omega$	30		188	ns

Typical Performance Characteristics

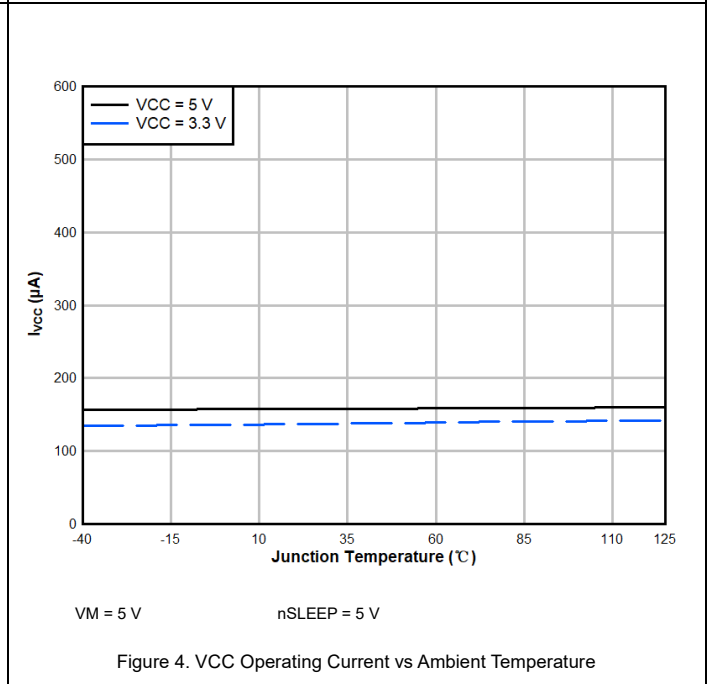
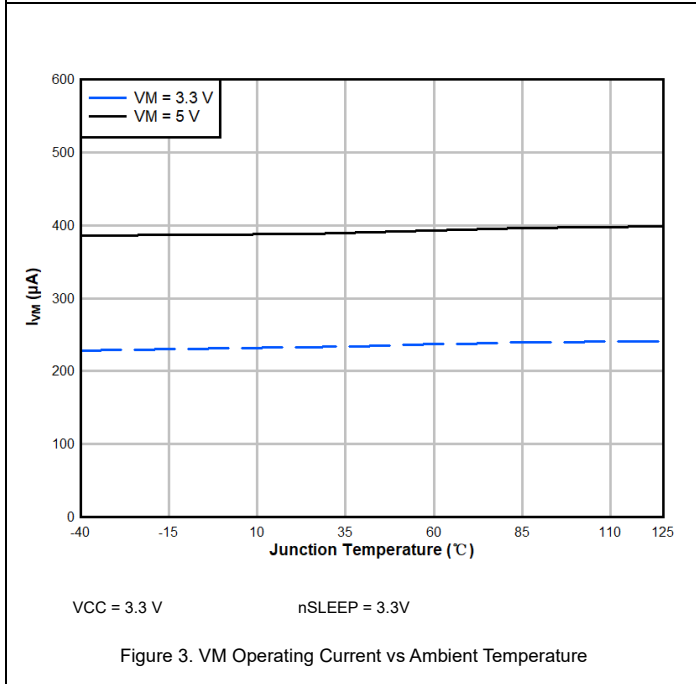
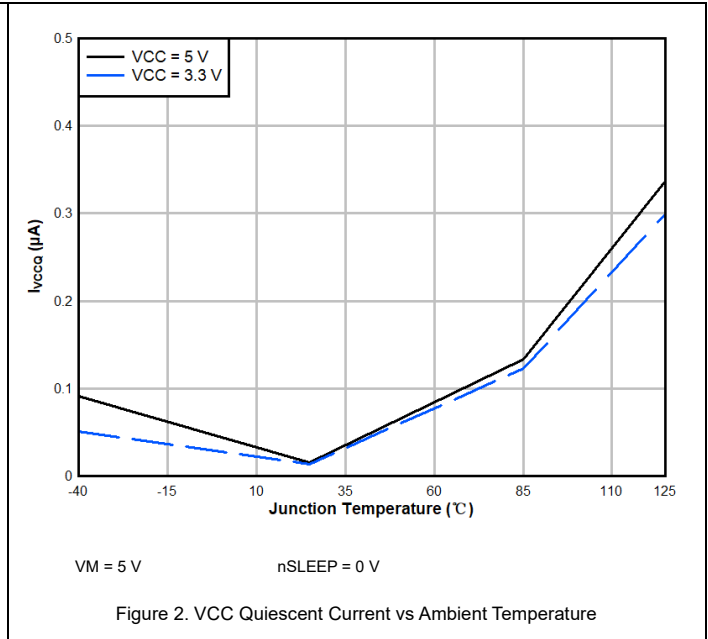
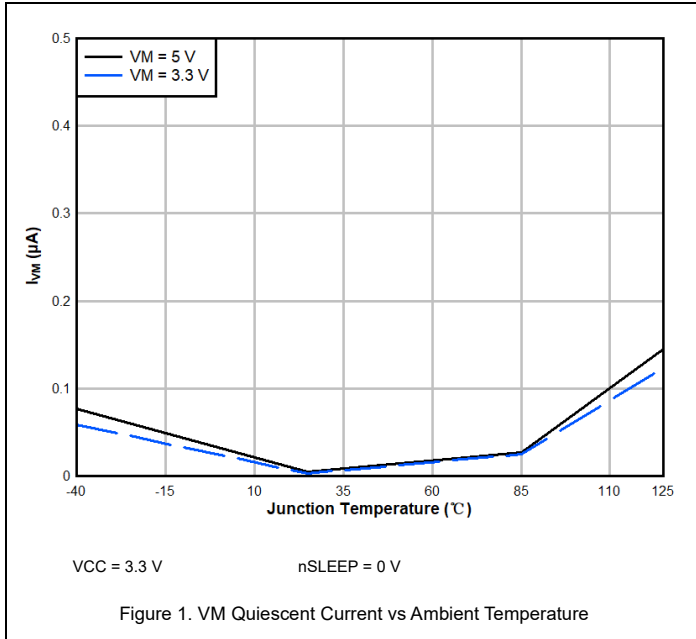

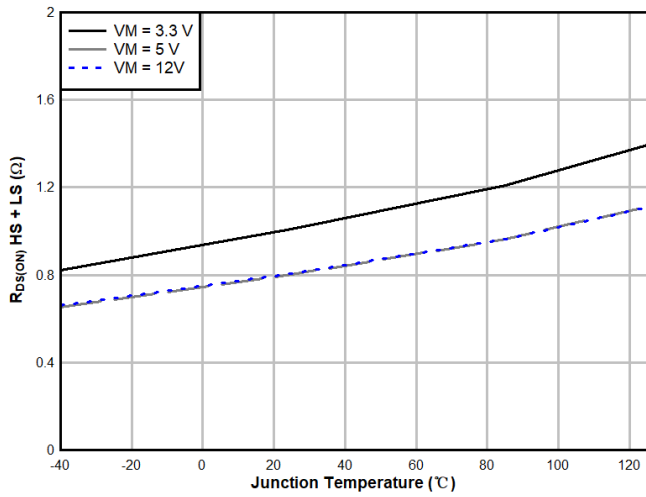

VCC = 3.3 V nSLEEP = 3.3V

Figure 5. HS + LS $R_{DS(ON)}$ vs Ambient Temperature

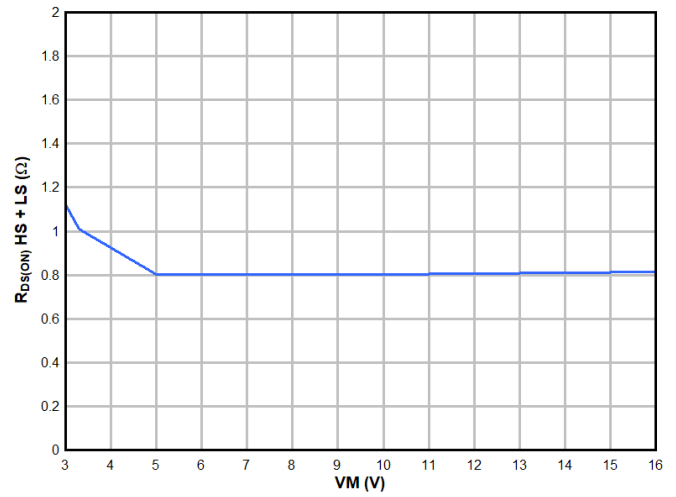

VCC = 3.3 V nSLEEP = 3.3V $T_A = 25^\circ\text{C}$

Figure 6. HS + LS $R_{DS(ON)}$ vs VM

Detailed Description

Overview

The TPM8837C is a high-voltage H-bridge driver. It is designed to control inductive loads such as DC motors, solenoids and relays. It can provide up-to 1-A drive current with maximum 17-V power supply.

The TPM8837C features a solution for motors used widely in consumer products, toys and other low-to-mid voltage or battery-powered motion control applications. The output driver is an H-bridge with VM voltage ranges from 2.5V to 17V. Control logic can operate on 1.8-V, 3.3-V and 5-V rails.

Internal protection features such as overcurrent protection, short circuit protection, undervoltage lockout and overtemperature improve reliability of the whole system. It is recommended that the device keeps IN1/IN2 low during nSLEEP rising edge.

Protection features include

- Overcurrent protection
- Short circuit protection
- Over-temperature protection.
- Under-voltage lockout

Functional Block Diagram

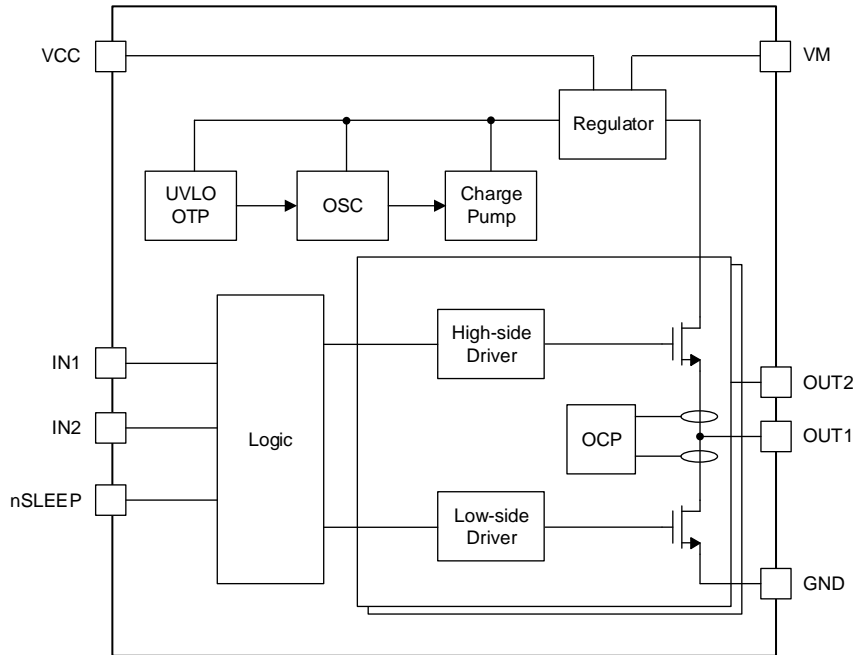

Figure 7 Functional Block Diagram

Feature Description

Timing

- All logic inputs have a deglitch circuitry to prevent noise from affecting the output state. The input deglitch time is around *100ns*.
- The output slew delay time is the delay contributed by gate drivers. In order to control the output rise/fall time, the gate drive limits the slew rate of gate voltage of output FETs. Typical slew delay time is around *50ns*.
- The rise and fall time of the outputs depend on VM voltage and load conditions, and are controlled slowly to reduce EMI. Typical rise and fall time are *100ns*.
- The dead time is measured as the time when OUTx is Hi-Z between turning off one of the H-bridge FETs and turning on the other. When sourcing current out of the pin, the output falls to one diode drop below ground during dead time. When sinking current into the pin, the output rises to one diode drop above VM. The typical dead time is *100ns*.
- The propagation time is measured as the between an input edge to an output change. This time is the sum of the input deglitch time, output slew delay, and output rise/fall time. The propagation time is around *350ns*.

Bridge Control

The TPM8837C uses IN/IN mode to control H-bridge:

IN1	IN2	OUT1	OUT2	Function
0	0	Z	Z	Coast
0	1	L	H	Reverse
1	0	H	L	Forward
1	1	L	L	Brake

The highside driver has a weak internal pull-up to VM during Hi-Z state.

Protections

- Over-current protection (OCP): All FETs are protected by current limit circuitry. Whenever the channel current of anyone of FETs exceeds overcurrent protection trip level, I_{OCP} , and persists for longer than the overcurrent deglitch time, t_{DEG} , the H-

bridge is disabled. After about 1ms, t_{OCR} , all bridges are re-enabled automatically.

- Short-circuit protection: thanks to the OCP function, the device is protected from OUT1 to OUT2 short-circuit, OUT1/OUT2 to ground short-circuit, and OUT1/OUT2 to VM short-circuit. When short-circuit occurs, no damage on IC and IR-CUT,
- Thermal shutdown (TSD): If the die temperature exceeds safe limits, all FETs in the H-bridge disable. Operation automatically resumes once the die temperature falls to a safe level.
- Under-voltage lockout (UVLO): If at any time the voltage on the VCC pins falls below the under-voltage lockout threshold voltage, all circuitry in the device disable, and internal logic resets. Operation resumes when VCC rises above the UVLO threshold.
- During power-up, it is recommended to keep IN1/IN2 to GND to ensure clean start up.

Fault	Condition	Error Report	H-bridge	Internal circuits	Recovery
VM UVLO	$VM < UVLO$	None	Disabled	Disabled	$VM > UVLO$
Overcurrent (OCP)	$I_{OUT} > I_{OCP}$	None	Disabled	Operating	t_{OCR}
Thermal shutdown (TSD)	$T_J > T_{SD}$	None	Disabled	Operating	$T_J < T_{SD} - T_{HYS}$

Device Functional Modes

Operating Mode	Condition	H-Bridge	Internal Circuits
Operating	$VM > UVLO$	Operating	Operating
Sleep Mode	$VM = 0V$	Disabled	Disabled
Fault encountered	Any fault conditions met	Disabled	See previous table

Tape and Reel Information

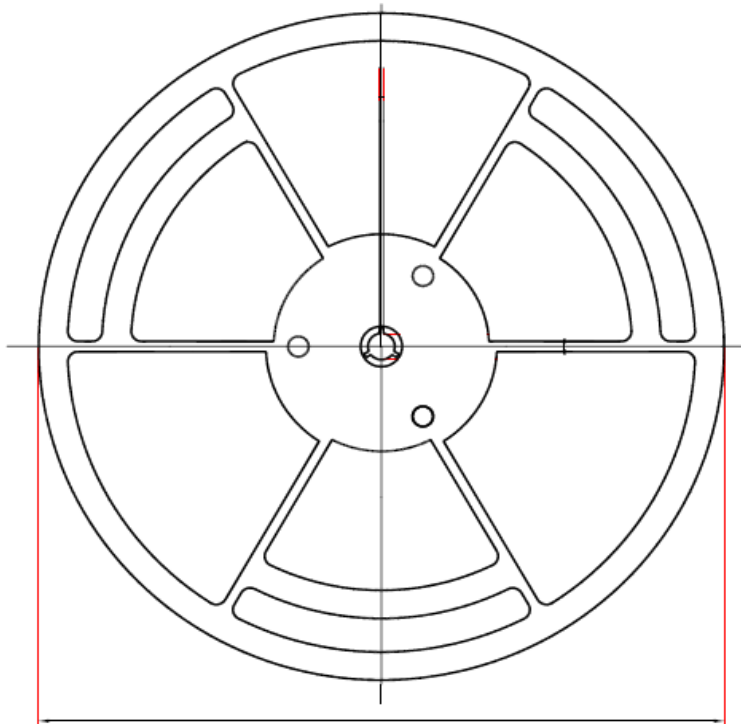

D1: Reel Diameter

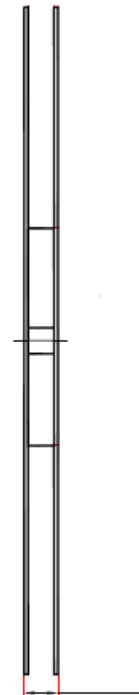

W1: Reel Width

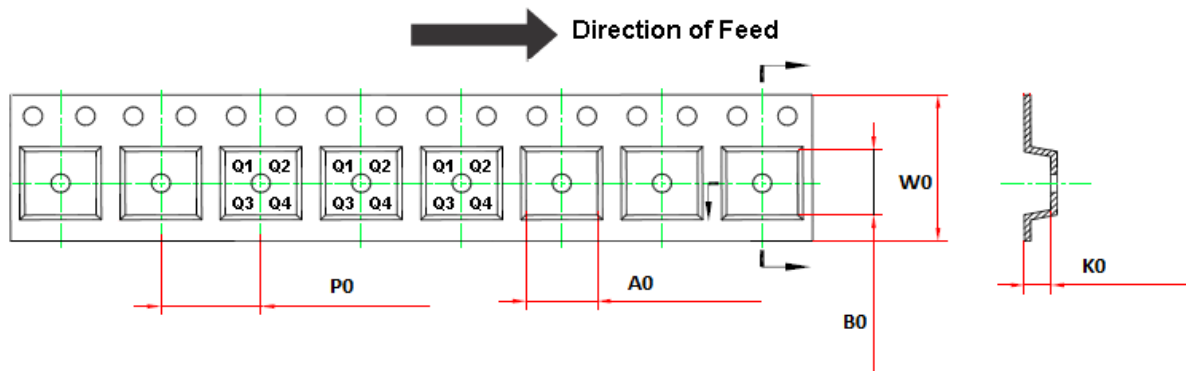

Order Number	Package	D1	W1	A0	B0	K0	P0	W0	Pin1 Quadrant
TPM8837C-DF4R	DFN2X2-8L	180.0	13.1	2.3	2.3	1.1	4.0	8.0	Q1
TPM8837C-SO1R	SOP8	330.0	17.6	6.4	5.4	2.1	8.0	12.0	Q1

Package Outline Dimensions

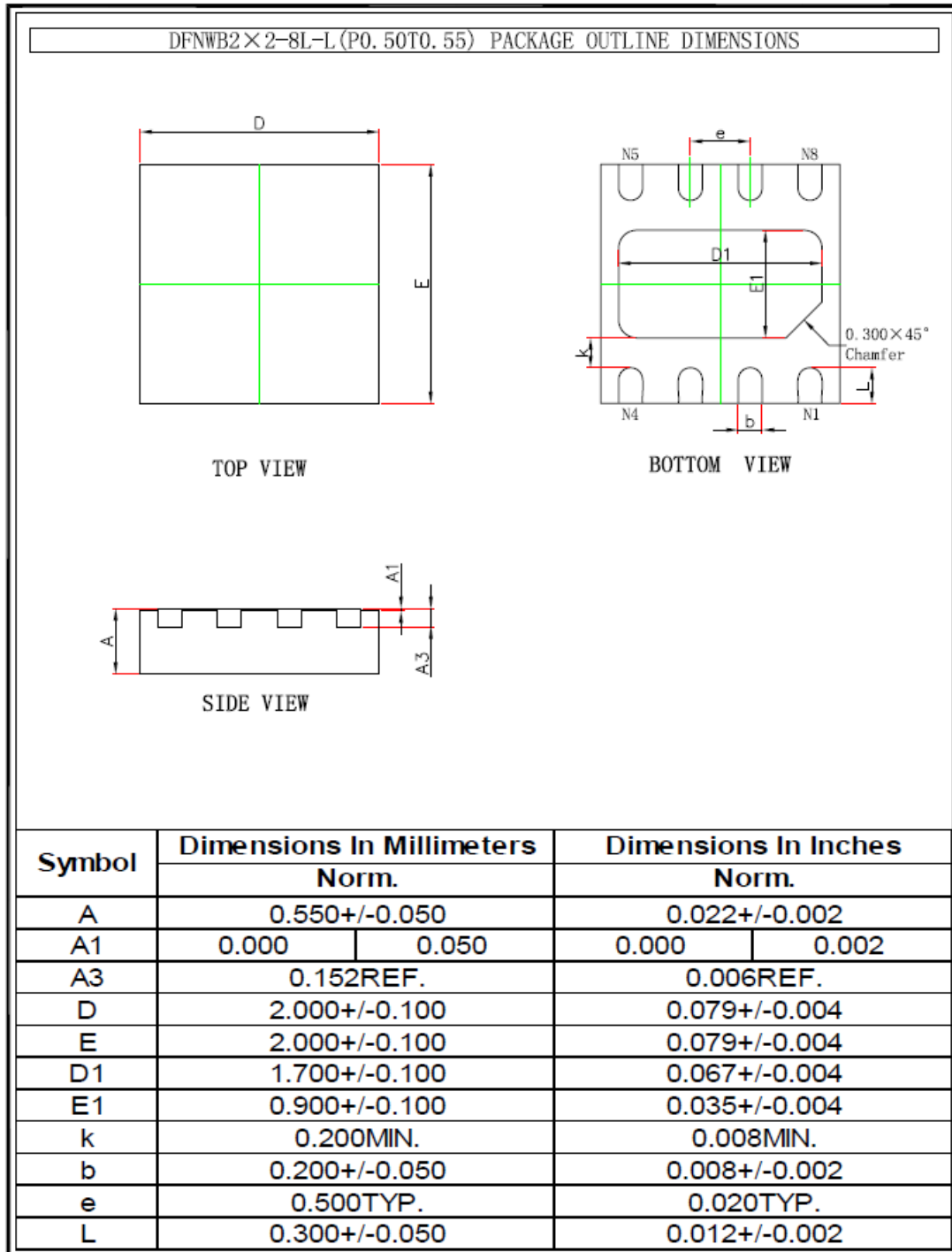

Aug. 2013, REV. A02

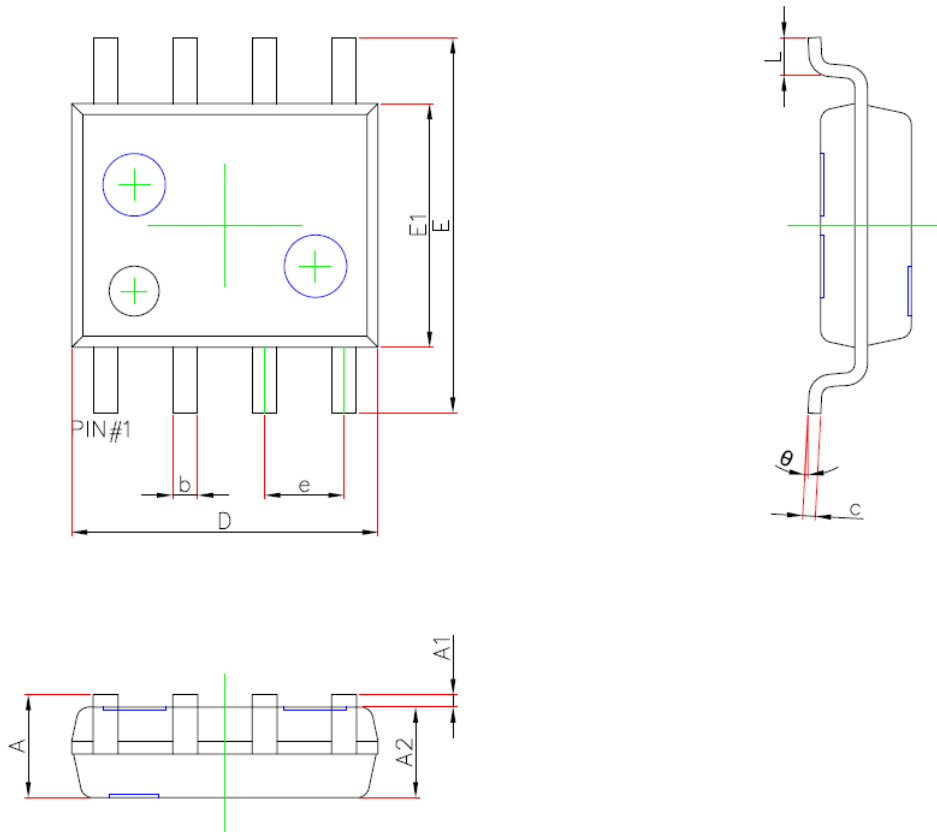

Symbol	Dimensions In Millimeters		Dimensions In Inches	
	Min.	Max.	Min.	Max.
A	1.350	1.750	0.053	0.069
A1	0.100	0.250	0.004	0.010
A2	1.350	1.550	0.053	0.061
b	0.330	0.510	0.013	0.020
c	0.170	0.250	0.007	0.010
D	4.700	5.100	0.185	0.201
E	5.800	6.200	0.228	0.244
E1	3.800	4.000	0.150	0.157
e	1.270(BSC)		0.050(BSC)	
L	0.400	0.800	0.016	0.031
θ	0°	8°	0°	8°

 **3PEAK and the 3PEAK logo are registered trademarks of 3PEAK INCORPORATED. All other trademarks are the property of their respective owners.**

单击下面可查看定价，库存，交付和生命周期等信息

[>>3PEAK\(思瑞浦\)](#)