

To: 唯样

---

No.:

## SPECIFICATIONS

Product Type	Multilayer Polymer Aluminum Electrolytic Capacitors
Series	400L
Description	6.3V150 $\mu$ F, V
Part No.	PA400LV157M0J

Fujian Guoguang Xinye Science & Technology Co., Ltd.

Address: Room 1110, Floor 1, No.160, Jiangbin East Road, Mawei District, Fuzhou City, Fujian Province

TEL: +86-591-83989615/83989616 / FAX: +86-591-83977125 (P.C. 350015)

Date	Approved by	Checked by	Drawn by
2020/8/7	Yuming Huang	Qiushui Zhang	Changfeng Wei

User	

Change History of Specification

Issued Date	Contents	Reason	Page	Mark	Issue No.
2020/8/7	Original	-	1 to 11	-	0

## Contents

No.	Item	Page
1	Scope	4
2	Explanation of Part Numbers	4
3	Product Specifications	4
4	Dimensions	5
5	Characteristics	5~7
6	Marking	8
7	Tape & Reel Packaging	8
8	Application Guidelines	9~11
9	HSF Compliance Declaration	11

### 1. Scope

This specification applies to 400L series polymer aluminum electrolytic capacitors for use in electronic equipment.

### 2. Explanation of Part Numbers

#### 2.1 Type Designation

P A	400L	V	157	M	0J
-----	------	---	-----	---	----

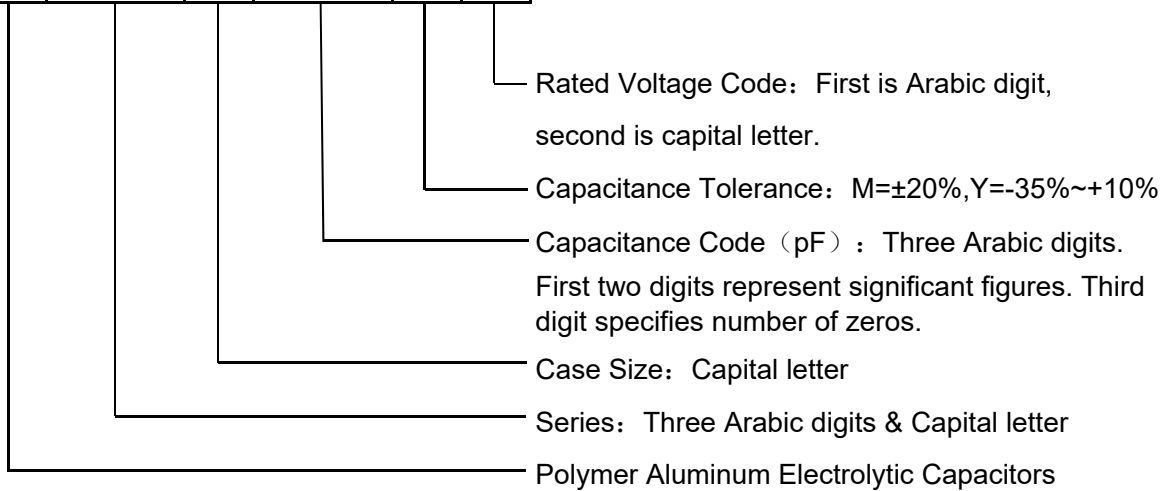

#### 2.2 Rated Voltage Code

Rated Voltage (V.DC)	6.3
Rated Voltage Code	0J

### 3. Product Specifications

Item	Performance Characteristics	
Operating Temperature Range	-55 °C ~ +105 °C	
Rated Voltage( $U_R$ )	6.3 V	
Nominal Capacitance( $C_N$ )	150 $\mu$ F	
Capacitance Range	120 $\mu$ F ~ 180 $\mu$ F	20 °C, 120 Hz
Leakage Current( $I_L$ )	94.5 $\mu$ A (max.)	20 °C, after 2 minutes
Dissipation Factor( $\tan\delta$ )	0.06 (max.)	20 °C, 120 Hz
Equivalent Series Resistance( $R_{ESR}$ )	15 m $\Omega$ (max.)	20 °C, 100 kHz

Part Number	$U_R$ (V.DC)	$C_N$ 120Hz/20°C ( $\mu$ F)	$\tan\delta$ 120Hz/20°C max.	$I_L$ 2 min/20 °C max. ( $\mu$ A)	$R_{ESR}$ 100kHz/20°C max. (m $\Omega$ )	Rated Ripple Current 100kHz/20 °C~105 °C max. (A)
PA400LV157M0J	6.3	150	0.06	94.5	15	3.9

## 4. Dimensions

### 4.1 Outline Drawing

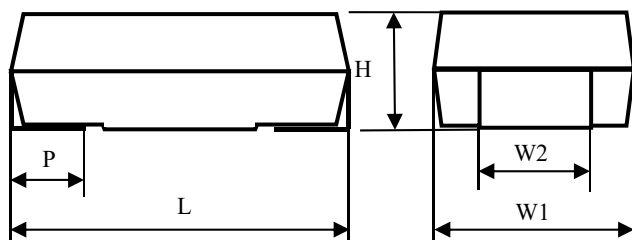

### 4.2 Size Code and Dimensions

Size Code	Dimensions mm				
	L±0.3	W1±0.3	H±0.2	P±0.3	W2±0.1
V	7.3	4.3	1.9	1.3	2.4

## 5. Characteristics

No.	Item	Outline of Test Method	Characteristics	
1	Capacitance Range	Measuring frequency: 120 Hz±12 Hz Measuring temperature: 20 °C	120 μF~180 μF	
2	Leakage Current ( $I_L$ )	Protective resistor: 1 000 Ω Applied voltage: Rated voltage Measuring: after 2 minutes Measuring temperature: 20 °C	94.5 μA (max.)	
3	Dissipation Factor (tanδ)	Measuring frequency: 120 Hz±12 Hz Measuring temperature: 20 °C	0.06 (max.)	
4	Equivalent Series Resistance	Measuring frequency: 100 kHz±10 Hz Measuring temperature: 20 °C	15 mΩ (max.)	
5	Resistance to Soldering Heat	Test method: the reflow method Reflow temperature profile: See Chapter 8.7 Recovery period: 24 h ±2 h	Visual examination Capacitance change ( $\Delta C/C$ ) tanδ $R_{ESR}$ $I_L$	No visible damage Legible marking ≤±10% of initial measured value ≤initial limit ≤initial limit ≤initial limit
6	Solderability	Test method: the reflow method	Visual examination	Areas to be soldered shall be covered with a new solder coating with no more than a small amount of scattered imperfections such as pinholes or un-wetted or de-wetted areas. These imperfections shall not be concentrated in one area

No.	Item	Outline of Test Method	Characteristics	
7	Solvent Resistance of the Marking	Solvent to be used: IPA Solvent temperature: 23 °C±5 °C Method 1 (with rubbing) Rubbing material: cotton wool Recovery time: not applicable	Visual examination	No visible damage Legible marking
8	Component Solvent Resistance	Solvent to be used: IPA Solvent temperature: 23 °C±5 °C Duration of immersion: 5 min±0.5 min Method 2 (without rubbing) Recovery time: 48 h	Visual examination	No visible damage Legible marking
9	Substrate Bending Test	Deflection D: 1 mm The number of bends: one The substrate shall be maintained for 20 s±1 s. Capacitance shall be measured with printed board in bent position.	Visual examination Capacitance change (ΔC/C) tanδ	No visible damage ≤±5% of initial measured value ≤initial limit
10	Shear Test	Push direction: side Force: 5 N Holding time: 10 s±1 s	Visual examination	No visible damage
11	Rapid Change of Temperature	T <sub>A</sub> =-55 °C±3 °C T <sub>B</sub> =+105 °C±3 °C Five cycles Duration: t <sub>1</sub> = 30 min Recovery time: 1 h~2 h	Visual examination Capacitance change (ΔC/C) tanδ I <sub>L</sub>	No visible damage Legible marking ≤±10% of initial measured value ≤initial limit ≤initial limit
12	Climatic Sequence	Dry heat: Temperature: +105 °C±3 °C Duration: 16 h Recovery time: ≥4 h Damp heat, cyclic, test Db, first cycle: Duration: 24 h Temperature: 55 °C Cold: Temperature: -55 °C±3 °C Duration: 2 h Recovery time: ≥4 h Damp heat, cyclic, test Db, remaining cycles: Number of cycles: 1 Duration: 24 h Temperature: 55 °C Recovery time: 1 h~2 h	Visual examination Capacitance change (ΔC/C) tanδ I <sub>L</sub>	No visible damage Legible marking ≤±10% of initial measured value ≤initial limit ≤initial limit

No.	Item	Outline of Test Method	Characteristics	
13	Damp Heat, Steady State	Temperature: 60 °C±2 °C Humidity: (93±3) %RH No voltage shall be applied Duration: 21 d Recovery time: 1 h~2 h	Visual examination Capacitance change (ΔC/C) tanδ I <sub>L</sub>	No visible damage Legible marking -20%~+50% of initial measured value ≤2 times initial limit ≤2 times initial limit
14	Characteristics at High and Low Temperature	The capacitors shall be measured at each temperature step: Step 1: 20 °C±2 °C (Initial value measuring)	—	—
		Step 2: -55 °C±3 °C	Capacitance change (ΔC/C) tanδ	≤±20% of value measured in Step 1 ≤2 times initial limit
		Step 3: +105 °C±3 °C	Capacitance change (ΔC/C) tanδ I <sub>L</sub>	≤±20% of value measured in Step 1 ≤2 times initial limit ≤5 times initial limit
15	Charge and Discharge	Temperature: 15 °C~35 °C Number of cycles: 10 <sup>6</sup> Duration of charge: 0.5 s Duration of discharge: 0.5 s	Visual examination Capacitance change (ΔC/C) tanδ R <sub>ESR</sub> I <sub>L</sub>	No visible damage Legible marking ≤±20% of initial measured value ≤1.5 times initial limit ≤2 times initial limit ≤initial limit
16	Endurance	Test temperature: +105 °C±3 °C Voltage: U <sub>R</sub> Duration: 2 000 h Recovery: 1 h~2 h	Visual examination Capacitance change (ΔC/C) tanδ R <sub>ESR</sub> I <sub>L</sub>	No visible damage Legible marking ≤±20% of initial measured value ≤1.5 times initial limit ≤2 times initial limit ≤initial limit
17	Storage at High Temperature	Test temperature: +105 °C±3 °C Duration: 500 <sup>+24</sup> <sub>0</sub> h Recovery: 16 h	Visual examination Capacitance change (ΔC/C) tanδ I <sub>L</sub>	No visible damage Legible marking ≤±20% of initial measured value ≤initial limit ≤2 times initial limit
18	Surge	Test temperature: 15 °C~35 °C Voltage: 1.25U <sub>R</sub> Duration of charge: 30 s Duration of no load: 5 min 30 s Number of cycles: 1 000 Protective resistor: 1 000 Ω	Visual examination Capacitance change (ΔC/C) tanδ I <sub>L</sub>	No visible damage Legible marking ≤±10% of initial measured value ≤initial limit ≤initial limit

## 6. Marking

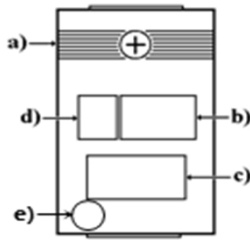

- a) Polarity indicator (Positive)
- b) Nominal capacitance
- c) Rated voltage
- d) Guoguang ID (G)
- e) Polarity indicator (Negative)

## 7. Tape & Reel Packaging

Packaging Diagram:

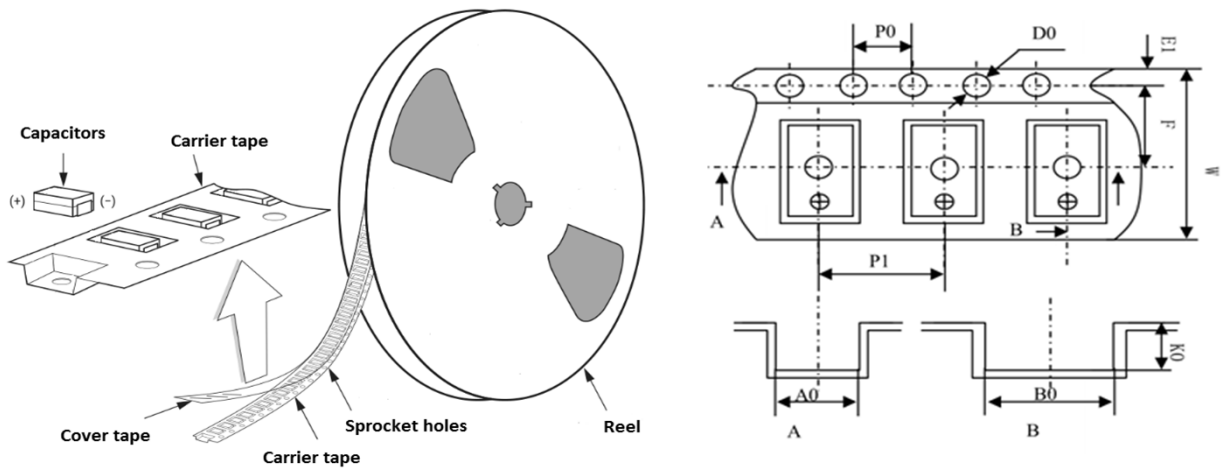

Case Size		Tape Dimensions (mm)				
Code	L×W1×H	P0	P1	A0	B0	W
	(mm)	±0.10	±0.10	±0.20	±0.20	±0.20
		4	8	4.6	7.6	12
V	7.3×4.3×1.9	K0	E1	F	D0	
		±0.10	±0.10	±0.10	$^{+0.10}_{-0.00}$	
		2.3	1.75	5.5	1.5	

Packing Quantity:

Reel size	180mm (7")	330mm (13")
Quantity (pcs)	1,200	4,200



## 8. Application Guidelines

To ensure the stable quality of the capacitor, and make full use of its capability, please read following guidelines before use:

### 8.1 Polarity

PA-Cap polymer aluminum electrolytic capacitors have polarity. Polarity must be identified before use. If the polarity is reversed, the leakage current of this capacitor will increase rapidly, even more it will make the circuit short.

### 8.2 Voltage

The application of over-voltage will increase the leakage current, so that the capacitor will be damaged because of the rise of its interior temperature. The sum of DC voltage and ripple voltage should not exceed the rated voltage.

### 8.3 Temperature

The capacitor must be used in or under the rated temperature. Operation at temperatures exceeding specifications will cause large changes in electrical properties. The potential deterioration will also lead to the failure of the capacitor. When thinking about the operating temperature of the capacitor, be sure to include not only the ambient temperature but also interior heat coming from the components.

### 8.4 Ripple current

Use the capacitor in permitted ripple current. When excessive ripple current is applied to the capacitor, it will cause the increasement of leakage current, short circuits and decreasing in life.

### 8.5 Storage of capacitor

Capacitors should be stored in a moisture proof and without direct sunlight environment. The prefer temperature is 5 °C~30 °C, relative humidity is lower than 60% RH.

Moisture Sensitivity Level: Level 3.

To maintain good mounting capability, please keep the capacitors in the state as delivered. Products should be all used within the storage term after opening the package. Please put the remaining products back into the packaging bag and seal the unsealed part with adhesive tape.

Storage term of the products: 24 months after manufactured (before opening the package), 7 days after opening. After the storage limit, drying treatment is necessary, condition: 50 °C ±2 °C, 100 h to 200 h.

### 8.6 Capacitor measurement

Excessive impact current resulted from charge and discharge hastily will cause the increasement of leakage current, even short circuit. Therefore the capacitor should be serially attached to a 1 kΩ protective resistor, and the applied voltage should be gradually increased to be equal to the rated voltage during the leakage current measurement. Before measuring other parameters, 1 KΩ resistor should be connected in series to make the capacitor discharge fully.

### 8.7 Capacitor mounting

Recommended land-pattern:

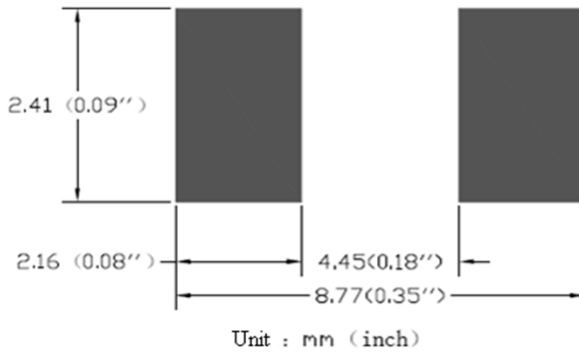

PA-Cap is suit to re-flow soldering, recommended curve for soldering is as following.

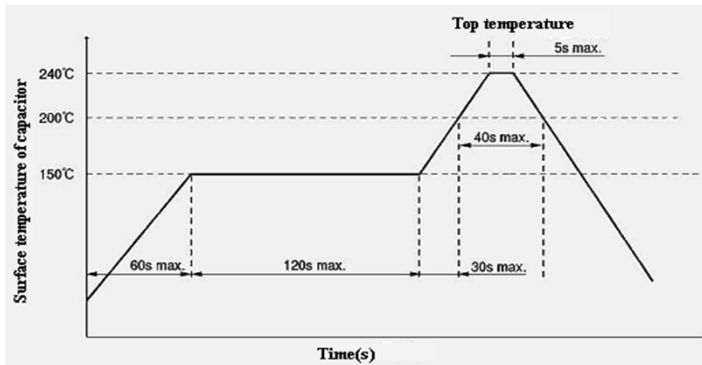

Recommended curve for lead free soldering is as following.

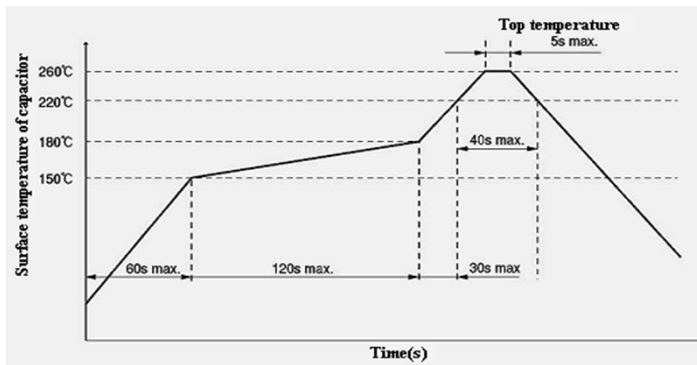

When using the electric iron, the electric soldering bit should not touch the case. Make sure that the soldering temperature is no more than 350 °C and the time is shorter than 3 seconds.

Before mounting, please confirm whether the lead size is suit to the designed dimensions of the circuit board. Do not distort and apply strong force to the capacitor during mounting, otherwise the electrical performance of the capacitor will be affected greatly, even damaged. After it is soldered on PCB board, do not remove it with strong force.

In addition, re-flow soldering should be no more than two times.

8.8 Capacitors cannot be used in the following environments:

- a) Contact directly with water, salt water or oil.
- b) Full of deleterious chemically active gases.
- c) Exposed to direct sunlight.

## 9. HSF Compliance Declaration

This product conforms to the ROHS 2011 / 65 / EU standard and the IEC 61249-2-21:2003 standard .

---

单击下面可查看定价，库存，交付和生命周期等信息

[>>福建国光](#)