

## 2A PicoTLynx™: Non-Isolated DC-DC Power Modules

3Vdc –14Vdc input; 0.6Vdc to 5.5Vdc output; 2A Output Current .

**TUNABLE  
LOOP**



RoHS Compliant

### Applications

- Distributed power architectures
- Intermediate bus voltage applications
- Telecommunications equipment
- Servers and storage applications
- Networking equipment
- Industrial equipment

### Features

- Compliant to RoHS II EU "Directive 2011/65/EU"
- Compatible in a Pb-free or SnPb reflow environment (Z versions)
- Wide Input voltage range (3Vdc-14Vdc)
- Output voltage programmable from 0.6Vdc to 5.5Vdc via external resistor
- Tunable Loop™ to optimize dynamic output voltage response
- Remote sense
- Power Good signal
- Fixed switching frequency
- Output overcurrent protection (non-latching)
- Overtemperature protection
- Remote On/Off
- Ability to sink and source current
- Cost efficient open frame design
- Small size: 12.2 mm x 12.2 mm x 6.25mm (0.48 in x 0.48 in x 0.246in)
- Wide operating temperature range (-40°C to 85°C)
- UL\* 60950-1 Recognized, CSA† C22.2 No. 60950-1-03 Certified, and VDE‡ 0805:2001-12 (EN60950-1) Licensed
- ISO\*\* 9001 and ISO 14001 certified manufacturing facilities

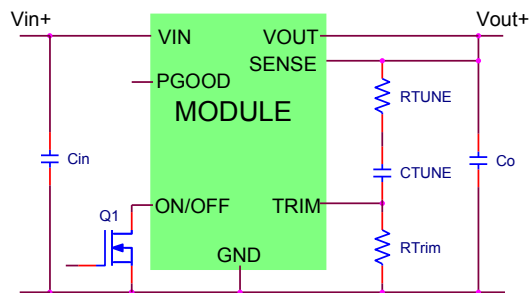

### Description

The 12V PicoTLynx™ 2A power modules are non-isolated dc-dc converters that can deliver up to 2A of output current. These modules operate over a wide range of input voltage ( $V_{IN} = 3Vdc-14Vdc$ ) and provide a precisely regulated output voltage from 0.6Vdc to 5.5Vdc, programmable via an external resistor. Features include remote On/Off, adjustable output voltage, over current and over temperature protection. A new feature, the Tunable Loop™, allows the user to optimize the dynamic response of the converter to match the load with reduced amount of output capacitance leading to savings on cost and PWB area.

\* UL is a registered trademark of Underwriters Laboratories, Inc.

† CSA is a registered trademark of Canadian Standards Association.

‡ VDE is a trademark of Verband Deutscher Elektrotechniker e.V.

\*\* ISO is a registered trademark of the International Organization of Standards

# The PMBus name and logo are registered trademarks of the System Management Interface Forum (SMIF)

## 2A PicoTLynx™: Non-Isolated DC-DC Power Modules

3Vdc –14Vdc input; 0.6Vdc to 5.5Vdc output; 2A Output Current

### Absolute Maximum Ratings

Stresses in excess of the absolute maximum ratings can cause permanent damage to the device. These are absolute stress ratings only, functional operation of the device is not implied at these or any other conditions in excess of those given in the operations sections of the data sheet. Exposure to absolute maximum ratings for extended periods can adversely affect the device reliability.

Parameter	Device	Symbol	Min	Max	Unit
Input Voltage Continuous	All	$V_{IN}$	-0.3	15	Vdc
Operating Ambient Temperature (see Thermal Considerations section)	All	$T_A$	-40	85	°C
Storage Temperature	All	$T_{stg}$	-55	125	°C

### Electrical Specifications

Unless otherwise indicated, specifications apply over all operating input voltage, resistive load, and temperature conditions.

Parameter	Device	Symbol	Min	Typ	Max	Unit
Operating Input Voltage	All	$V_{IN}$	3.0	—	14.0	Vdc
Maximum Input Current ( $V_{IN}=3V$ to 14V, $I_o=I_{o,max}$ )	All	$I_{IN,max}$			1.8A	Adc
Input No Load Current ( $V_{IN} = 12.0Vdc$ , $I_o = 0$ , module enabled)	$V_{o,set} = 0.6 Vdc$	$I_{IN,No load}$		20		mA
	$V_{o,set} = 5.5Vdc$	$I_{IN,No load}$		48		mA
Input Stand-by Current ( $V_{IN} = 12.0Vdc$ , module disabled)	All	$I_{IN,stand-by}$		8		mA
Inrush Transient	All	$I^2t$			1	A <sup>2</sup> s
Input Reflected Ripple Current, peak-to-peak (5Hz to 20MHz, 1 $\mu$ H source impedance; $V_{IN} = 0$ to 14V, $I_o = I_{o,max}$ ; See Test Configurations)	All			20		mAp-p
Input Ripple Rejection (120Hz)	All			-65		dB

**CAUTION: This power module is not internally fused. An input line fuse must always be used.**

This power module can be used in a wide variety of applications, ranging from simple standalone operation to an integrated part of sophisticated power architecture. To preserve maximum flexibility, internal fusing is not included; however, to achieve maximum safety and system protection, always use an input line fuse. The safety agencies require a fast-acting fuse with a maximum rating of 4A (see Safety Considerations section). Based on the information provided in this data sheet on inrush energy and maximum dc input current, the same type of fuse with a lower rating can be used. Refer to the fuse manufacturer's data sheet for further information.

## 2A PicoTLynx™: Non-Isolated DC-DC Power Modules

3Vdc –14Vdc input; 0.6Vdc to 5.5Vdc output; 2A Output Current

## Electrical Specifications (continued)

Parameter	Device	Symbol	Min	Typ	Max	Unit
Output Voltage Set-point (with 0.5% tolerance for external resistor used to set output voltage)	All	$V_{O, set}$	-1.5		+1.5	% $V_{O, set}$
Output Voltage (Over all operating input voltage, resistive load, and temperature conditions until end of life)	All	$V_{O, set}$	-2.5	—	+2.5	% $V_{O, set}$
Adjustment Range (selected by an external resistor) (Some output voltages may not be possible depending on the input voltage – see Feature Descriptions Section)	All	$V_O$	0.6		5.5	Vdc
Remote Sense Range	All				0.5	Vdc
Output Regulation (for $V_O \geq 2.5$ Vdc)						
Line ( $V_{IN}=V_{IN, min}$ to $V_{IN, max}$ )	All			—	+0.4	% $V_{O, set}$
Load ( $I_O=I_{O, min}$ to $I_{O, max}$ )	All			—	10	mV
Output Regulation (for $V_O < 2.5$ Vdc)						
Line ( $V_{IN}=V_{IN, min}$ to $V_{IN, max}$ )	All			—	10	mV
Load ( $I_O=I_{O, min}$ to $I_{O, max}$ )	All			—	5	mV
Temperature ( $T_{ref}=T_{A, min}$ to $T_{A, max}$ )	All			—	0.4	% $V_{O, set}$
Output Ripple and Noise on nominal output ( $V_{IN}=V_{IN, nom}$ and $I_O=I_{O, min}$ to $I_{O, max}$ $C_O = 0.1\mu F // 10\mu F$ ceramic capacitors)						
Peak-to-Peak (5Hz to 20MHz bandwidth)	All		—	50	100	mV <sub>pk-pk</sub>
RMS (5Hz to 20MHz bandwidth)	All			20	38	mV <sub>rms</sub>
External Capacitance <sup>1</sup>						
Without the Tunable Loop™						
ESR $\geq 1$ m $\Omega$	All	$C_O$	22	—	47	$\mu F$
With the Tunable Loop™						
ESR $\geq 0.15$ m $\Omega$	All	$C_{O, max}$	0	—	1000	$\mu F$
ESR $\geq 10$ m $\Omega$	All	$C_{O, max}$	0	—	3000	$\mu F$
Output Current (in either sink or source mode)	All	$I_O$	0		2	A <sub>dc</sub>
Output Current Limit Inception (Hiccup Mode) (current limit does not operate in sink mode)	All	$I_{O, lim}$		180		% $I_{O, max}$
Output Short-Circuit Current ( $V_O \leq 250$ mV) ( Hiccup Mode )	All	$I_{O, s/c}$		140		mA
Efficiency	$V_{O, set} = 0.6$ Vdc	$\eta$		68.7		%
$V_{IN} = 12$ Vdc, $T_A = 25^\circ C$	$V_{O, set} = 1.2$ Vdc	$\eta$		80.7		%
	$V_{O, set} = 1.8$ Vdc	$\eta$		85.9		%
	$V_{O, set} = 2.5$ Vdc	$\eta$		89		%
	$V_{O, set} = 3.3$ Vdc	$\eta$		91.1		%
	$V_{O, set} = 5.0$ Vdc	$\eta$		93.6		%
Switching Frequency	All	$f_{sw}$	—	600	—	kHz

External capacitors may require using the new Tunable Loop™ feature to ensure that the module is stable as well as getting the best transient response. See the Tunable Loop™ section for details.

## 2A PicoTLynx™: Non-Isolated DC-DC Power Modules

3Vdc –14Vdc input; 0.6Vdc to 5.5Vdc output; 2A Output Current

### General Specifications

Parameter	Device	Min	Typ	Max	Unit
Calculated MTBF ( $I_o=0.8I_{o,max}$ , $T_A=40^\circ\text{C}$ ) Telecordia Issue 2 Method 1 Case 3	APXS		26,121,938		Hours
Weight		—	0.9(0.0317)	—	g (oz.)

### Feature Specifications

Unless otherwise indicated, specifications apply over all operating input voltage, resistive load, and temperature conditions. See Feature Descriptions for additional information.

Parameter	Device	Symbol	Min	Typ	Max	Unit
On/Off Signal Interface ( $V_{IN}=V_{IN,min}$ to $V_{IN,max}$ ; open collector or equivalent, Signal referenced to GND)						
Device Code with no suffix – Negative Logic (See Ordering Information) (On/OFF pin is open collector/drain logic input with external pull-up resistor; signal referenced to GND)						
Logic High (Module OFF)						
Input High Current	All	$I_{IH}$	—	—	1	mA
Input High Voltage	All	$V_{IH}$	3	—	$V_{IN,max}$	Vdc
Logic Low (Module ON)						
Input low Current	All	$I_{IL}$	—	—	10	$\mu\text{A}$
Input Low Voltage	All	$V_{IL}$	-0.2	—	0.3	Vdc
Turn-On Delay and Rise Times						
( $V_{IN}=V_{IN,nom}$ , $I_o=I_{o,max}$ , $V_o$ to within $\pm 1\%$ of steady state)						
Case 1: On/Off input is enabled and then input power is applied (delay from instant at which $V_{IN} = V_{IN,min}$ until $V_o = 10\%$ of $V_{o,set}$ )	All	$T_{delay}$	—	5	—	msec
Case 2: Input power is applied for at least one second and then the On/Off input is enabled (delay from instant at which Von/Off is enabled until $V_o = 10\%$ of $V_{o,set}$ )	All	$T_{delay}$	—	5.2	—	msec
Output voltage Rise time (time for $V_o$ to rise from 10% of $V_{o,set}$ to 90% of $V_{o,set}$ )	All	$T_{rise}$	—	1.4	—	msec
Output voltage overshoot ( $T_A = 25^\circ\text{C}$ $V_{IN}= V_{IN,min}$ to $V_{IN,max}$ , $I_o = I_{o,min}$ to $I_{o,max}$ ) With or without maximum external capacitance					3.0	% $V_{o,set}$
Over Temperature Protection (See Thermal Considerations section)	All	$T_{ref}$	140			$^\circ\text{C}$

## 2A PicoTLynx™: Non-Isolated DC-DC Power Modules

3Vdc –14Vdc input; 0.6Vdc to 5.5Vdc output; 2A Output Current

## Feature Specifications (cont.)

Parameter	Device	Symbol	Min	Typ	Max	Units
Input Undervoltage Lockout						
Turn-on Threshold	All				2.95	Vdc
Turn-off Threshold	All				2.8	Vdc
Hysteresis	All			0.2		Vdc
PGOOD (Power Good)						
Signal Interface Open Drain, $V_{supply} \leq 5VDC$						
Overvoltage threshold for PGOOD				112.5		% $V_{O,set}$
Undervoltage threshold for PGOOD				87.5		% $V_{O,set}$
Pulldown resistance of PGOOD pin	All			30	70	$\Omega$

# 2A PicoTLynx™: Non-Isolated DC-DC Power Modules

3Vdc –14Vdc input; 0.6Vdc to 5.5Vdc output; 2A Output Current

## Characteristic Curves

The following figures provide typical characteristics for the APXS002A0X-SRZ (0.6V, 2A) at 25°C.

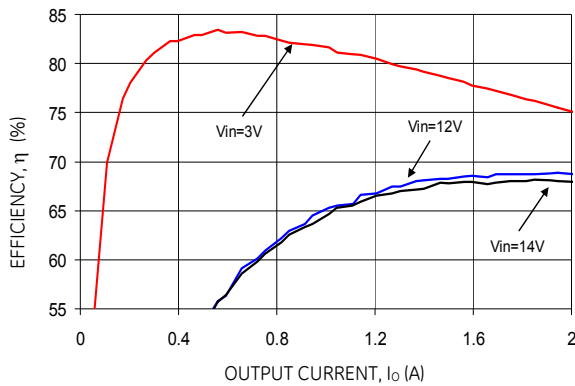

Figure 1. Converter Efficiency versus Output Current.

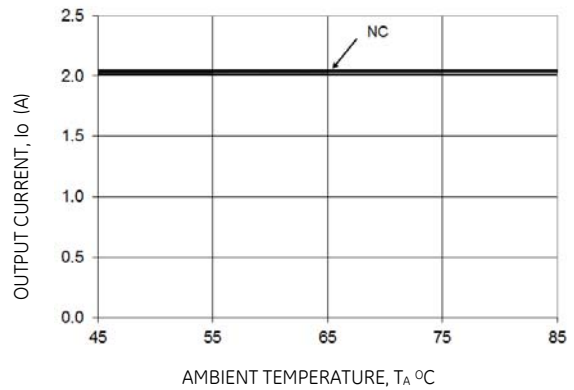

Figure 2. Derating Output Current versus Ambient Temperature and Airflow.

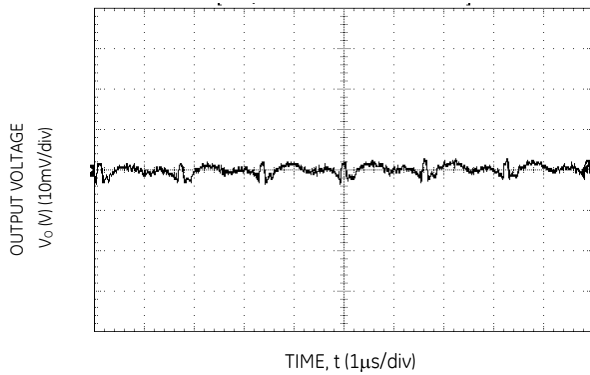

Figure 3. Typical output ripple and noise ( $V_{IN} = 12V, I_o = I_{o,max}$ ).

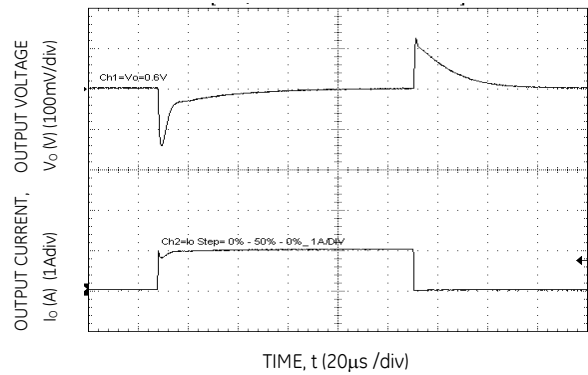

Figure 4. Transient Response to Dynamic Load Change from 0% to 50% to 0% .

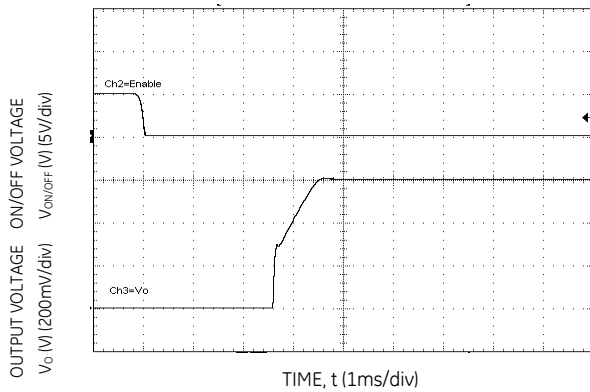

Figure 5. Typical Start-up Using On/Off Voltage ( $I_o = I_{o,max}, V_{in}=12V, C_{ext}= 22\mu F$ ).

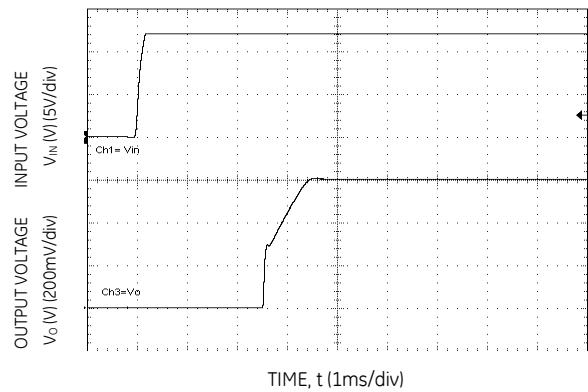

Figure 6. Typical Start-up Using Input Voltage ( $V_{IN} = 12V, I_o = I_{o,max}$ ).

# 2A PicoTLynx™: Non-Isolated DC-DC Power Modules

3Vdc –14Vdc input; 0.6Vdc to 5.5Vdc output; 2A Output Current

## Characteristic Curves

The following figures provide typical characteristics for the APXS002A0X-SRZ (1.2V, 2A) at 25°C.

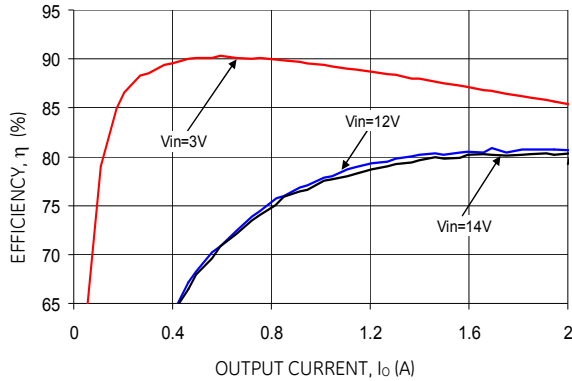

Figure 7. Converter Efficiency versus Output Current.

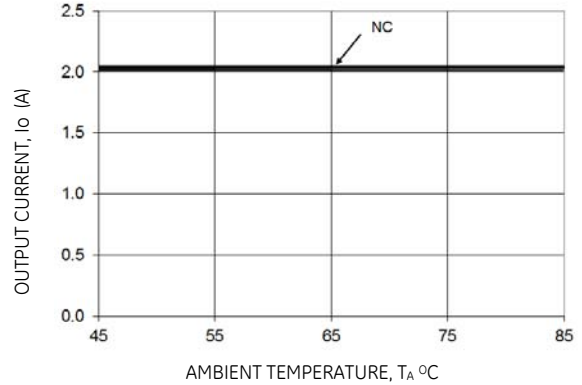

Figure 8. Derating Output Current versus Ambient Temperature and Airflow.

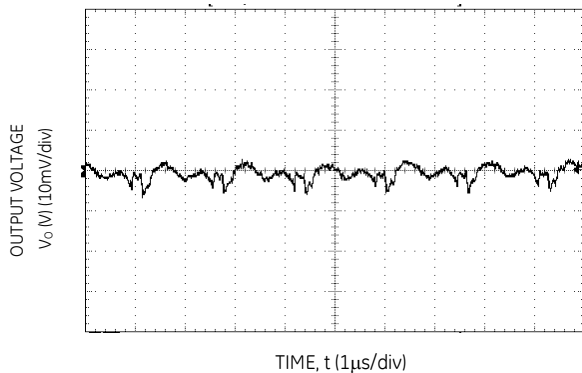

Figure 9. Typical output ripple and noise ( $V_{IN} = 12V$ ,  $I_o = I_{o,max}$ ).

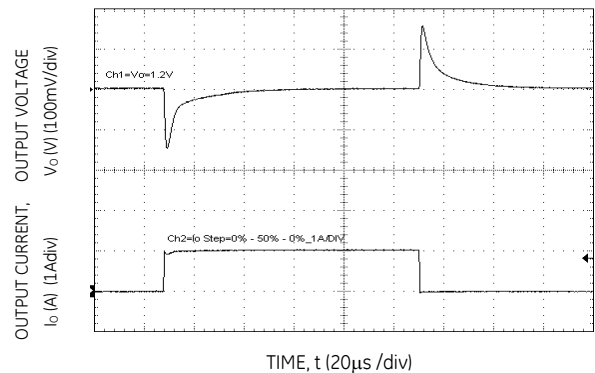

Figure 10. Transient Response to Dynamic Load Change from 0% to 50% to 0%.

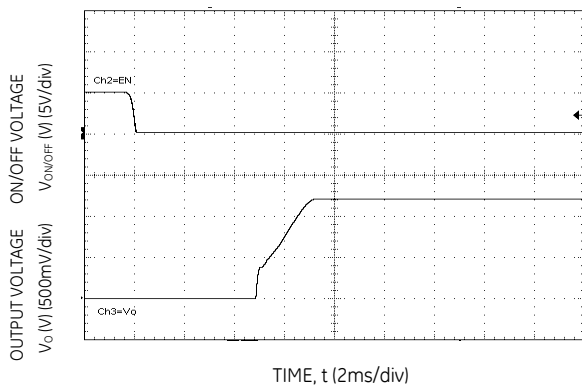

Figure 11. Typical Start-up Using On/Off Voltage ( $I_o = I_{o,max}$ ,  $V_{in}=12V$ ,  $C_{ext}= 22\mu F$ ).

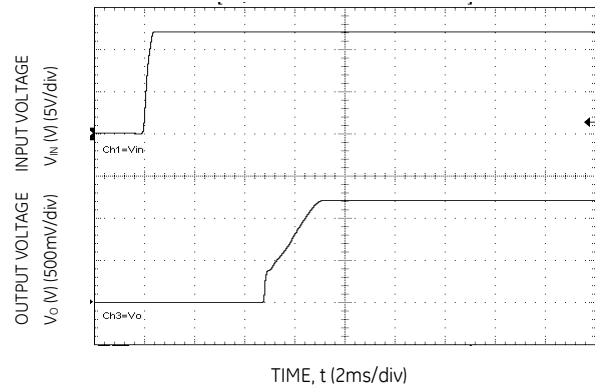

Figure 12. Typical Start-up Using Input Voltage ( $V_{IN} = 12V$ ,  $C_{ext}= 22\mu F$ ,  $I_o = I_{o,max}$ ).

# 2A PicoTLynx™: Non-Isolated DC-DC Power Modules

3Vdc –14Vdc input; 0.6Vdc to 5.5Vdc output; 2A Output Current

## Characteristic Curves

The following figures provide typical characteristics for the APXS002A0X-SRZ (1.8V, 2A) at 25°C.

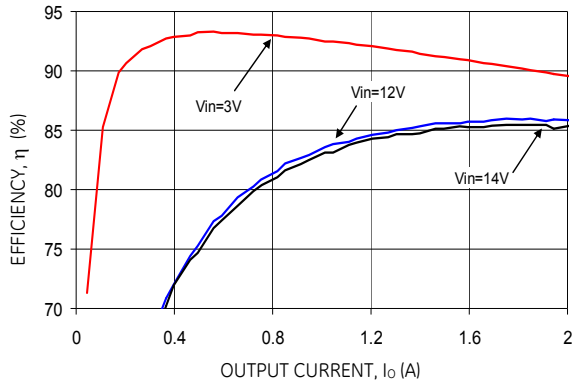

Figure 13. Converter Efficiency versus Output Current.

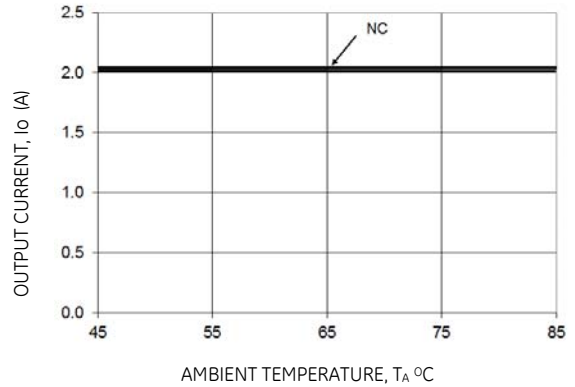

Figure 14. Derating Output Current versus Ambient Temperature and Airflow.

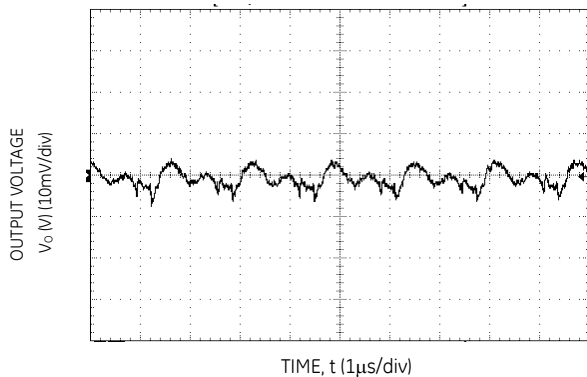

Figure 15. Typical output ripple and noise ( $V_{IN} = 12V$ ,  $I_o = I_{o,max}$ ).

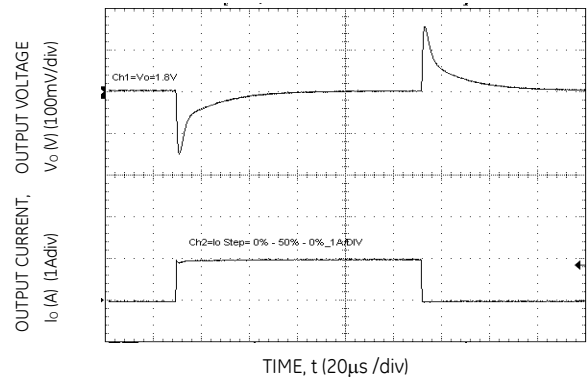

Figure 16. Transient Response to Dynamic Load Change from 0% to 50% to 0%.

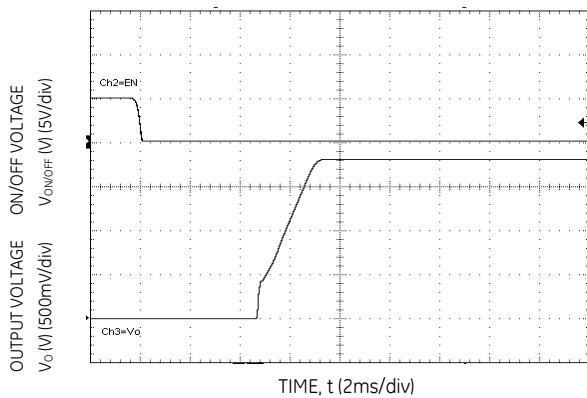

Figure 17. Typical Start-up Using On/Off Voltage ( $I_o = I_{o,max}$ ,  $V_{in}=12V$ ,  $C_{ext}= 22\mu F$ ).

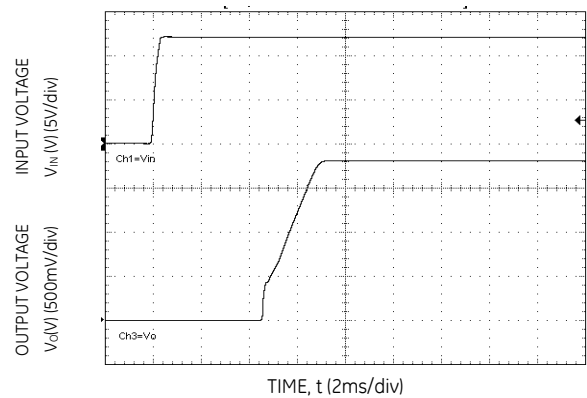

Figure 18. Typical Start-up Using Input Voltage ( $V_{IN} = 12V$ ,  $C_{ext}= 22\mu F$ ,  $I_o = I_{o,max}$ ).



# 2A PicoTLynx™: Non-Isolated DC-DC Power Modules

3Vdc –14Vdc input; 0.6Vdc to 5.5Vdc output; 2A Output Current

## Characteristic Curves

The following figures provide typical characteristics for the APXS002A0X-SRZ (2.5V, 2A) at 25°C.

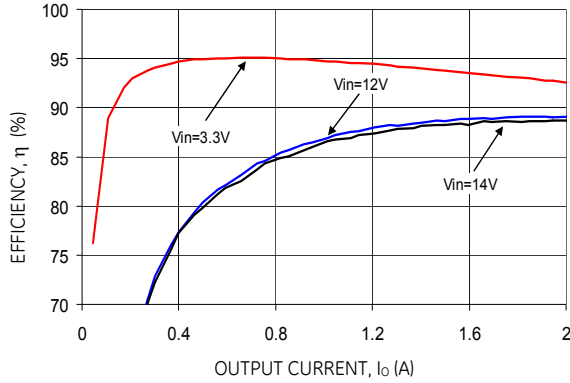

Figure 19. Converter Efficiency versus Output Current.

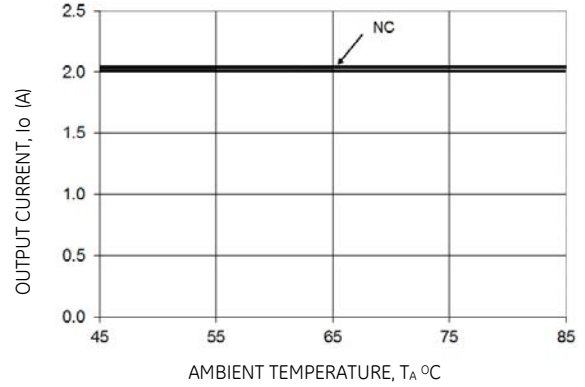

Figure 20. Derating Output Current versus Ambient Temperature and Airflow.

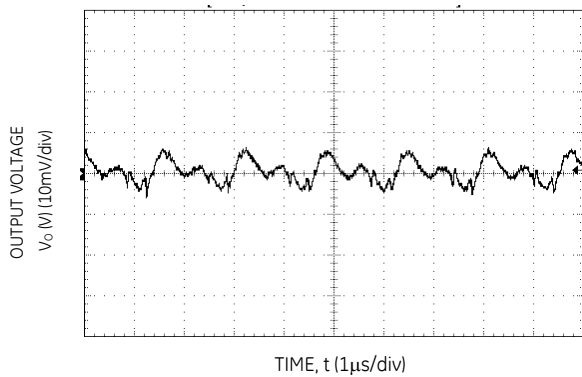

Figure 21. Typical output ripple and noise ( $V_{IN} = 12V$ ,  $I_o = I_{o,max}$ ).

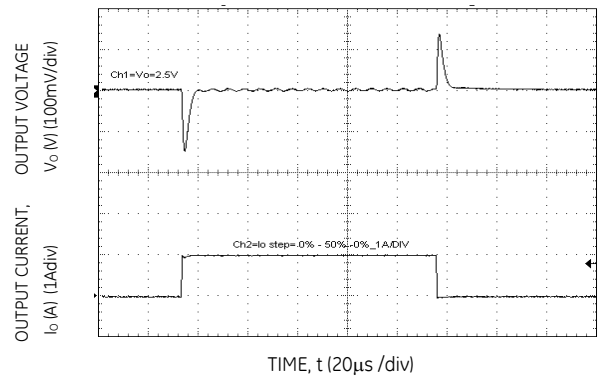

Figure 22. Transient Response to Dynamic Load Change from 0% to 50% to 0%.

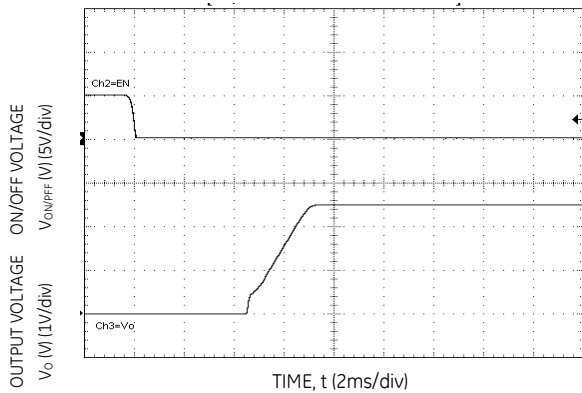

Figure 23. Typical Start-up Using On/Off Voltage ( $I_o = I_{o,max}$ ,  $V_{in}=12V$ ,  $C_{ext}= 22\mu F$ ).

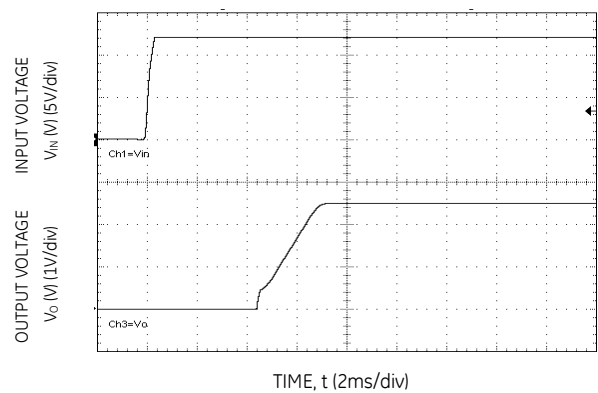

Figure 24. Typical Start-up Using Input Voltage ( $V_{IN} = 12V$ ,  $C_{ext}= 22\mu F$ ,  $I_o = I_{o,max}$ ).

# 2A PicoTLynx™: Non-Isolated DC-DC Power Modules

3Vdc –14Vdc input; 0.6Vdc to 5.5Vdc output; 2A Output Current

## Characteristic Curves

The following figures provide typical characteristics for the APXS002A0X-SRZ (3.3V, 2A) at 25°C.

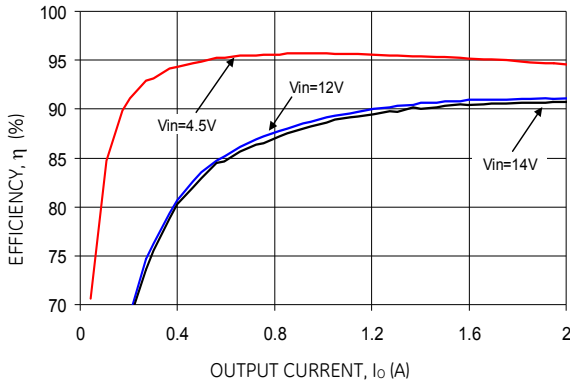

Figure 25. Converter Efficiency versus Output Current.

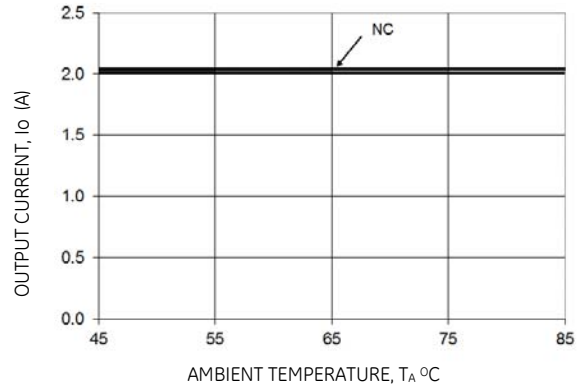

Figure 26. Derating Output Current versus Ambient Temperature and Airflow.

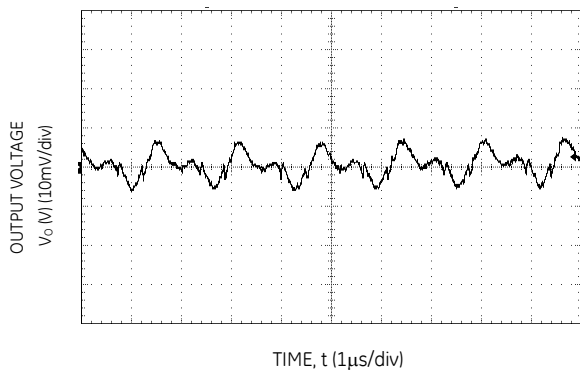

Figure 27. Typical output ripple and noise ( $V_{IN} = 12V$ ,  $I_o = I_{o,max}$ ).

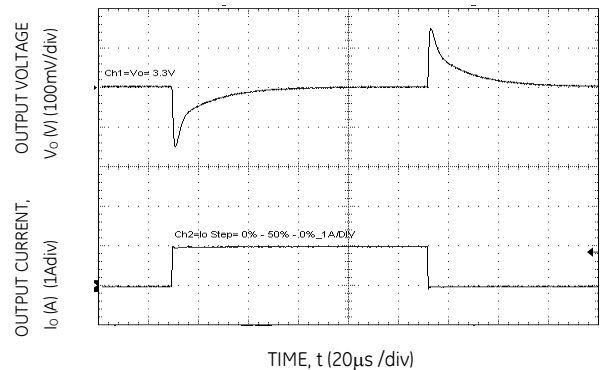

Figure 28. Transient Response to Dynamic Load Change from 0% to 50% to 0%.

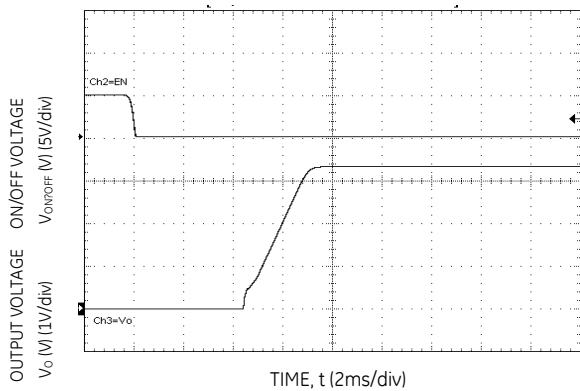

Figure 29. Typical Start-up Using On/Off Voltage ( $I_o = I_{o,max}$ ,  $V_{in}=12V$ ,  $C_{ext}= 22\mu F$ )

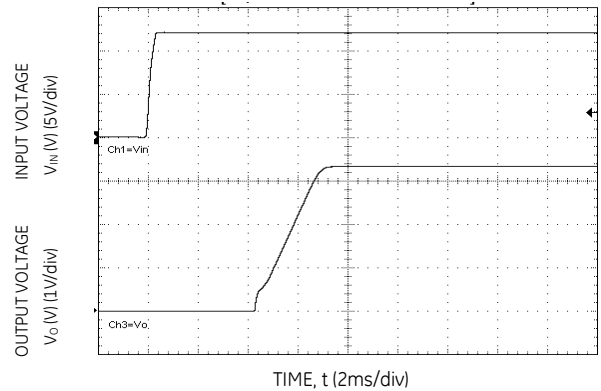

Figure 30. Typical Start-up Using Input Voltage ( $V_{in} = 12V$ ,  $C_{ext}= 22\mu F$ ,  $I_o = I_{o,max}$ ).

# 2A PicoTLynx™: Non-Isolated DC-DC Power Modules

3Vdc –14Vdc input; 0.6Vdc to 5.5Vdc output; 2A Output Current

## Characteristic Curves

The following figures provide typical characteristics for the APXS002A0X-SRZ (5V, 2A) at 25°C.

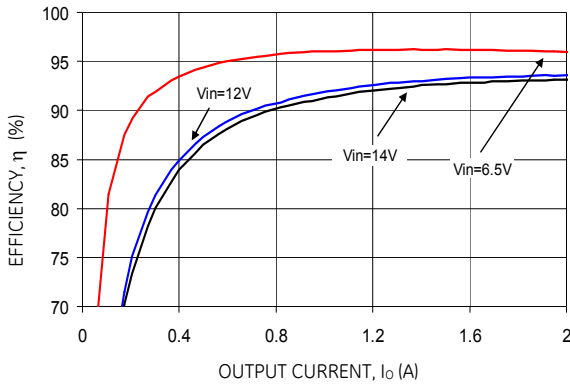

Figure 31. Converter Efficiency versus Output Current.

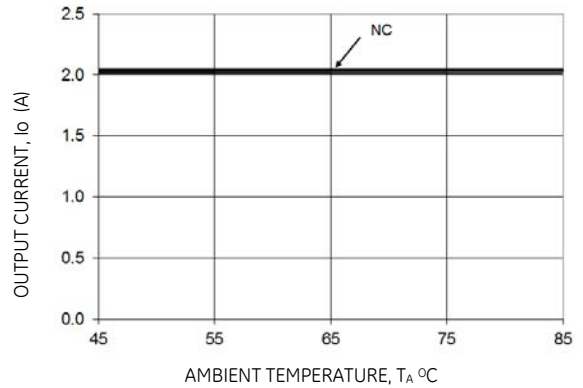

Figure 32. Derating Output Current versus Ambient Temperature and Airflow.

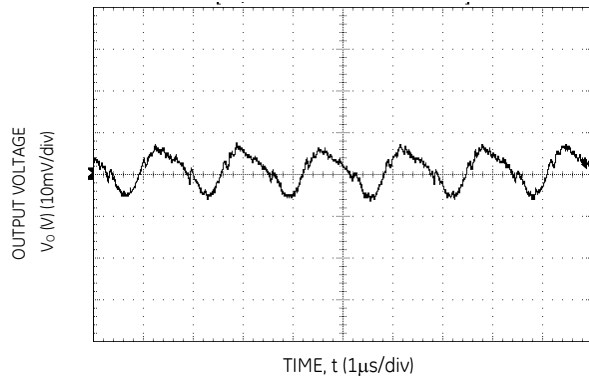

Figure 33. Typical output ripple and noise ( $V_{IN} = 12V$ ,  $I_o = I_{o,max}$ ).

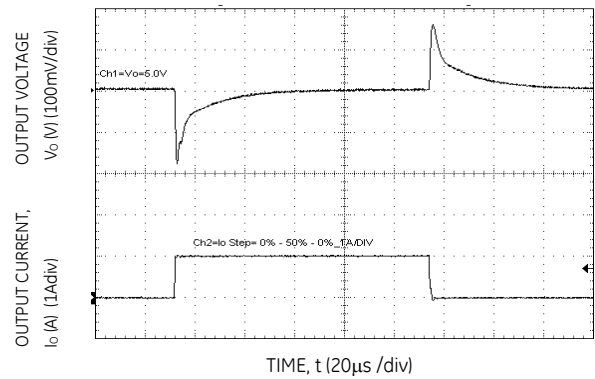

Figure 34. Transient Response to Dynamic Load Change from 0% to 50% to 0%.

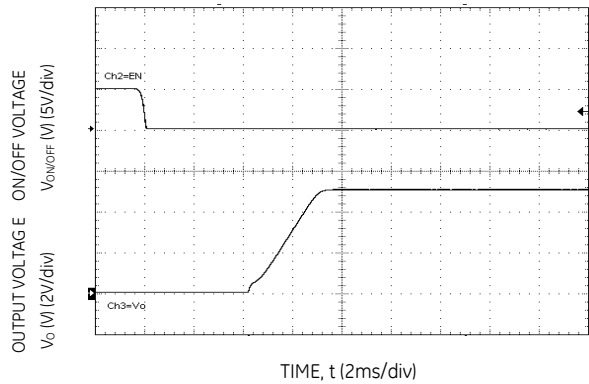

Figure 35. Typical Start-up Using On/Off Voltage ( $I_o = I_{o,max}$ ,  $V_{IN} = 12V$ ,  $C_{ext} = 22\mu F$ ).

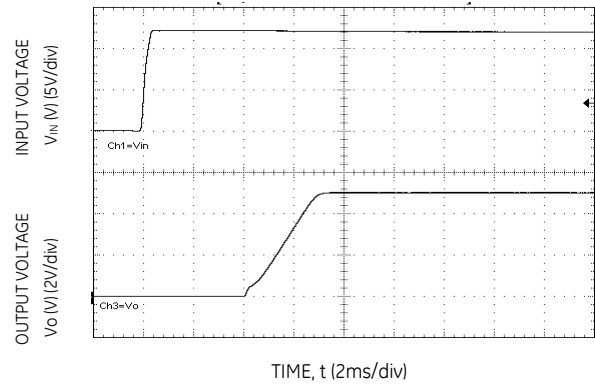
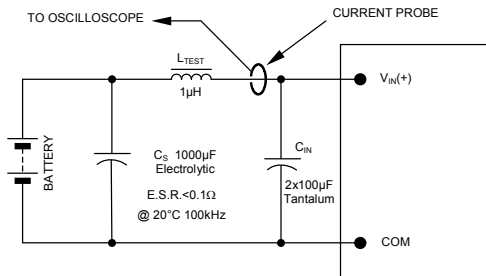

Figure 36. Typical Start-up Using Input Voltage ( $V_{IN} = 12V$ ,  $I_o = I_{o,max}$ ,  $C_{ext} = 22\mu F$ ).

# 2A PicoTLynx™: Non-Isolated DC-DC Power Modules

3Vdc –14Vdc input; 0.6Vdc to 5.5Vdc output; 2A Output Current

## Test Configurations



NOTE: Measure input reflected ripple current with a simulated source inductance ( $L_{TEST}$ ) of 1µH. Capacitor  $C_S$  offsets possible battery impedance. Measure current as shown above.

Figure 37. Input Reflected Ripple Current Test Setup.

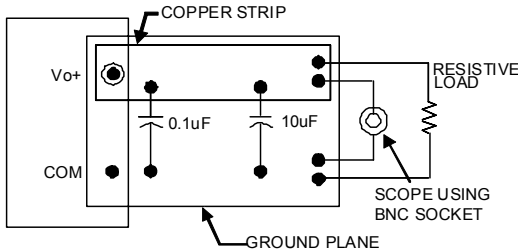

NOTE: All voltage measurements to be taken at the module terminals, as shown above. If sockets are used then Kelvin connections are required at the module terminals to avoid measurement errors due to socket contact resistance.

Figure 38. Output Ripple and Noise Test Setup.

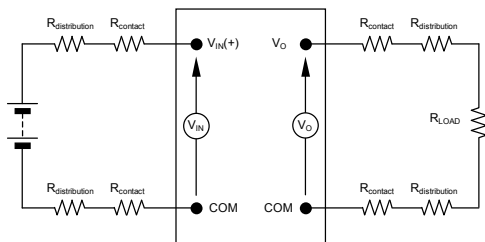

NOTE: All voltage measurements to be taken at the module terminals, as shown above. If sockets are used then Kelvin connections are required at the module terminals to avoid measurement errors due to socket contact resistance.

Figure 39. Output Voltage and Efficiency Test Setup.

$$\text{Efficiency } \eta = \frac{V_O \cdot I_O}{V_{IN} \cdot I_{IN}} \times 100 \%$$

## Design Considerations

### Input Filtering

The 12V PicoTLynx™ 2A module should be connected to a low ac-impedance source. A highly inductive source can affect the stability of the module. An input capacitance must be placed directly adjacent to the input pin of the module, to minimize input ripple voltage and ensure module stability.

To minimize input voltage ripple, ceramic capacitors are recommended at the input of the module. Figure 40 shows the input ripple voltage for various output voltages at 2A of load current with 1x10 µF or 1x22 µF ceramic capacitors and an input of 5V. Figure 41 shows the input ripple voltage for an input of 12V

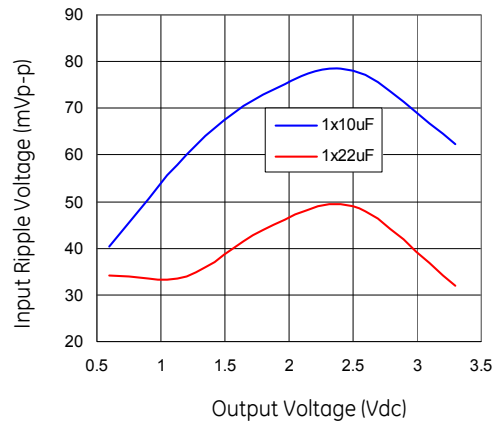

Figure 40. Input ripple voltage for various output voltages with 1x10 µF or 1x22 µF ceramic capacitors at the input (2A load). Input voltage is 5V.

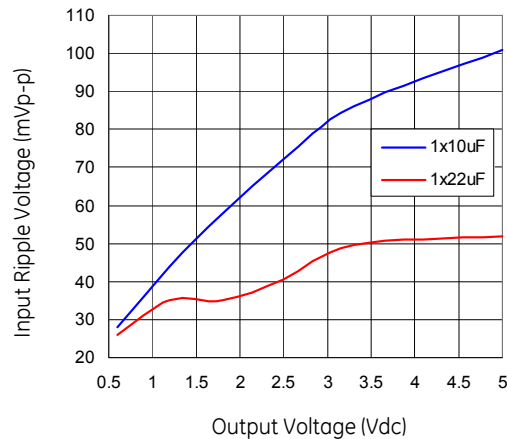

Figure 41. Input ripple voltage for various output voltages with 1x10 µF or 1x22 µF ceramic capacitors at the input (2A load). Input voltage is 12V.

### Output Filtering

The 12V PicoTLynx™ 2A modules are designed for low output ripple voltage and will meet the maximum output ripple specification with 0.1 µF ceramic and 22µF ceramic capacitors at the output of the module. However,

## 2A PicoTLynx™: Non-Isolated DC-DC Power Modules

3Vdc –14Vdc input; 0.6Vdc to 5.5Vdc output; 2A Output Current

additional output filtering may be required by the system designer for a number of reasons. First, there may be a need to further reduce the output ripple and noise of the module. Second, the dynamic response characteristics may need to be customized to a particular load step change.

To reduce the output ripple and improve the dynamic response to a step load change, additional capacitance at the output can be used. Low ESR polymer and ceramic capacitors are recommended to improve the dynamic response of the module. A minimum 22 $\mu$ F External Cap must be used. Figure 42 provides output ripple information for different external capacitance values at various  $V_o$  and for a load current of 2A. For stable operation of the module, limit the capacitance to less than the maximum output capacitance as specified in the electrical specification table. Optimal performance of the module can be achieved by using the Tunable Loop™ feature described later in this data sheet.

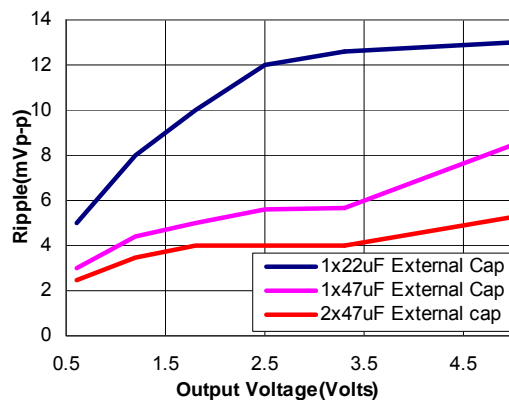

Figure 42. Output ripple voltage for various output voltages with external 1x22  $\mu$ F, 1x47  $\mu$ F or 2x47  $\mu$ F ceramic capacitors at the output (2A load). Input voltage is 12V.

### Safety Considerations

For safety agency approval the power module must be installed in compliance with the spacing and separation requirements of the end-use safety agency standards, i.e., UL 60950-1, CSA C22.2 No. 60950-1, and DIN EN 60950-1 (VDE 0805 Teil 1):2006-11

For the converter output to be considered meeting the requirements of safety extra-low voltage (SELV), the input must meet SELV requirements. The power module has extra-low voltage (ELV) outputs when all inputs are ELV.

The input to these units is to be provided with a fast-acting fuse with a maximum rating of 4A in the positive input lead.

### Feature Descriptions

#### Remote Enable

The 12V PicoTLynx™ 2A power modules feature an On/Off pin for remote On/Off operation. With the Negative Logic On/Off option, (no device code suffix, see Ordering Information), the module turns OFF during logic High and ON during logic Low. The On/Off signal is always referenced to ground. Leaving the On/Off pin disconnected will turn the module ON when input voltage is present.

The circuit configuration is shown in Fig. 43.

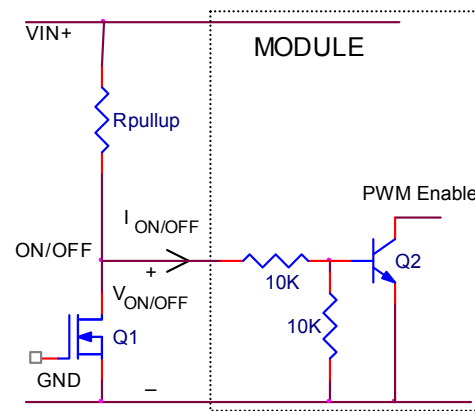

Figure 43. Circuit configuration for using negative On/Off logic.

#### Overcurrent Protection

To provide protection in a fault (output overload) condition, the unit is equipped with internal current-limiting circuitry and can endure current limiting continuously. At the point of current-limit inception, the unit enters hiccup mode. The unit operates normally once the output current is brought back into its specified range.

#### Overtemperature Protection

To provide protection in a fault condition, the unit is equipped with a thermal shutdown circuit. The unit will shutdown if the overtemperature threshold of 140°C is exceeded at the thermal reference point  $T_{ref}$ . The thermal shutdown is not intended as a guarantee that the unit will survive temperatures beyond its rating. Once the unit goes into thermal shutdown it will then wait to cool before attempting to restart.

#### Input Undervoltage Lockout

At input voltages below the input undervoltage lockout limit, the module operation is disabled. The module will begin to operate at an input voltage above the undervoltage lockout turn-on threshold.

## 2A PicoTLynx™: Non-Isolated DC-DC Power Modules

3Vdc –14Vdc input; 0.6Vdc to 5.5Vdc output; 2A Output Current

### Output Voltage Programming

The output voltage of the 12V PicoTLynx™ 2A modules can be programmed to any voltage from 0.6Vdc to 5.5Vdc by connecting a resistor between the Trim and GND pins of the module. Certain restrictions apply on the output voltage set point depending on the input voltage. These are shown in the Output Voltage vs. Input Voltage Set Point Area plot in Fig. 44. The Lower Limit curve shows that for output voltages of 2.4V and higher, the input voltage needs to be larger than the minimum of 3V.

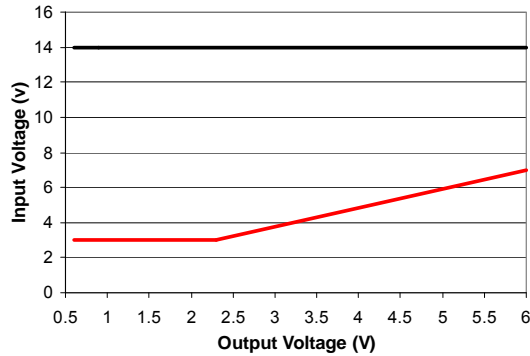

Figure 44. Output Voltage vs. Input Voltage Set Point Area plot showing limits where the output voltage can be set for different input voltages.

Without an external resistor between Trim and GND pins, the output of the module will be 0.6Vdc. To calculate the value of the trim resistor,  $R_{trim}$  for a desired output voltage, use the following equation:

$$R_{trim} = \left[ \frac{6.0}{(V_o - 0.6)} \right] k\Omega$$

$R_{trim}$  is the external resistor in  $k\Omega$

$V_o$  is the desired output voltage.

Table 1 provides  $R_{trim}$  values required for some common output voltages.

Table 1

$V_{o, set}$ (V)	$R_{trim}$ (K $\Omega$ )
1.0	15
1.2	10
1.5	6.67
1.8	5
2.5	3.16
3.3	2.22
5.0	1.36

By using a  $\pm 0.5\%$  tolerance trim resistor with a TC of  $\pm 100$ ppm, a set point tolerance of  $\pm 1.5\%$  can be achieved as specified in the electrical specification.

### Remote Sense

The 12V PicoTLynx™ 2A power modules have a Remote Sense feature to minimize the effects of distribution losses by

regulating the voltage at the SENSE pin. The voltage between the SENSE pin and VOUT pin must not exceed 0.5V. Note that the output voltage of the module cannot exceed the specified maximum value. This includes the voltage drop between the SENSE and Vout pins. When the Remote Sense feature is not being used, connect the SENSE pin to the VOUT pin.

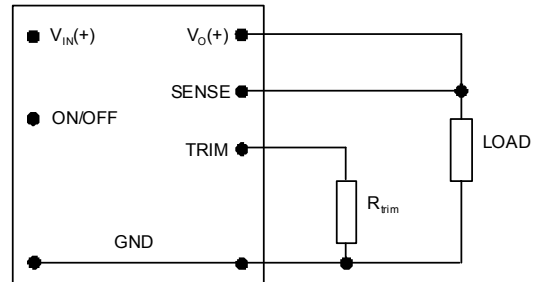

Figure 45. Circuit configuration for programming output voltage using an external resistor.

### Voltage Margining

Output voltage margining can be implemented in the 12V PicoTLynx™ 2A modules by connecting a resistor,  $R_{margin-up}$ , from the Trim pin to the ground pin for margining-up the output voltage and by connecting a resistor,  $R_{margin-down}$ , from the Trim pin to output pin for margining-down. Figure 46 shows the circuit configuration for output voltage margining. The POL Programming Tool, available at [www.lineagepower.com](http://www.lineagepower.com) under the Design Tools section, also calculates the values of  $R_{margin-up}$  and  $R_{margin-down}$  for a specific output voltage and % margin. Please consult your local GE Critical Power technical representative for additional details.

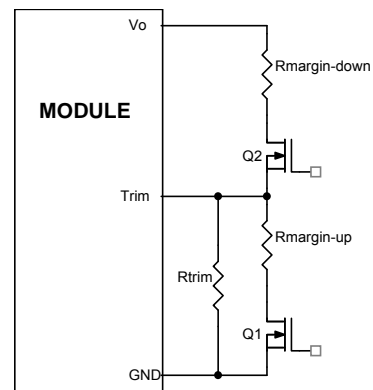

Figure 46. Circuit Configuration for margining Output voltage.

## 2A PicoTLynx™: Non-Isolated DC-DC Power Modules

3Vdc –14Vdc input; 0.6Vdc to 5.5Vdc output; 2A Output Current

### Monotonic Start-up and Shutdown

The 12V PicoTLynx™ 2A modules have monotonic start-up and shutdown behavior for any combination of rated input voltage, output current and operating temperature range.

### Startup into Pre-biased Output

The 12V PicoTLynx™ 2A modules can start into a prebiased output as long as the prebias voltage is 0.5V less than the set output voltage.

### Power Good

The 12V PicoTLynx™ 2A modules provide a Power Good (PGOOD) signal that is implemented with an open-drain output to indicate that the output voltage is within the regulation limits of the power module. The PGOOD signal will be de-asserted to a low state if any condition such as overtemperature, overcurrent or loss of regulation occurs that would result in the output voltage going  $\pm 12.5\%$  outside the setpoint value. The PGOOD terminal should be connected through a pullup resistor (suggested value 100K $\Omega$ ) to a source of 5VDC or lower.

### Tunable Loop™

The 12V PicoTLynx™ 2A modules have a new feature that optimizes transient response of the module called Tunable Loop™.

External capacitors are usually added to the output of the module for two reasons: to reduce output ripple and noise (see Fig. 52) and to reduce output voltage deviations from the steady-state value in the presence of dynamic load current changes. Adding external capacitance however affects the voltage control loop of the module, typically causing the loop to slow down with sluggish response. Larger values of external capacitance could also cause the module to become unstable.

The Tunable Loop™ allows the user to externally adjust the voltage control loop to match the filter network connected to the output of the module. The Tunable Loop™ is implemented by connecting a series R-C between the SENSE and TRIM pins of the module, as shown in Fig. 47. This R-C allows the user to externally adjust the voltage loop feedback compensation of the module.

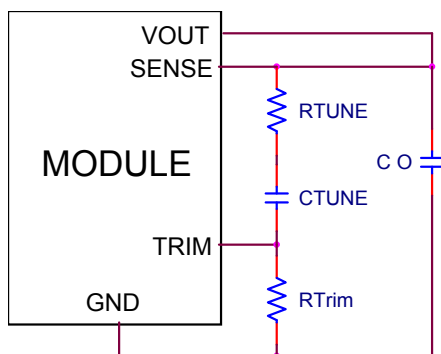

Figure 47. Circuit diagram showing connection of  $R_{TUNE}$  and  $C_{TUNE}$  to tune the control loop of the module.

Recommended values of  $R_{TUNE}$  and  $C_{TUNE}$  for different output capacitor combinations are given in Tables 2 and 3. Table 2 shows the recommended values of  $R_{TUNE}$  and  $C_{TUNE}$  for different values of ceramic output capacitors up to 470 $\mu$ F that might be needed for an application to meet output ripple and noise requirements. Selecting  $R_{TUNE}$  and  $C_{TUNE}$  according to Table 2 will ensure stable operation of the module.

In applications with tight output voltage limits in the presence of dynamic current loading, additional output capacitance will be required. Tables 3, 4 and 5 list recommended values of  $R_{TUNE}$  and  $C_{TUNE}$  in order to meet 2% output voltage deviation limits for some common output voltages in the presence of a 1A to 2A step change (50% of full load), for input voltages of 12V, 5V and 3.3V respectively.

Please contact your GE Critical Power technical representative to obtain more details of this feature as well as for guidelines on how to select the right value of external R-C to tune the module for best transient performance and stable operation for other output capacitance values or input voltages other than 12V.

Table 2. General recommended values of  $R_{TUNE}$  and  $C_{TUNE}$  for  $V_{in}=12V/5V/3.3V$  and various external ceramic capacitor combinations.

Co	1x47 $\mu$ F	2x47 $\mu$ F	3x47 $\mu$ F	4x47 $\mu$ F	10x47 $\mu$ F
$R_{TUNE}$	220	150	100	100	100
$C_{TUNE}$	3900pF	10nF	18nF	18nF	22nF

Table 3. Recommended values of  $R_{TUNE}$  and  $C_{TUNE}$  to obtain transient deviation of  $\leq 2\%$  of  $V_{out}$  for a 1A step load with  $V_{in}=12V$

$V_o$	5V	3.3V	2.5V	1.8V	1.2V	0.6V
Co	22 $\mu$ F	1x47 $\mu$ F	2x47 $\mu$ F	2x47 $\mu$ F	3x47 $\mu$ F	330 $\mu$ F Polymer
$R_{TUNE}$	220	220	150	150	100	100
$C_{TUNE}$	200pF	3900pF	10nF	10nF	18nF	68nF
$\Delta V$	81mV	61mV	35mV	34mV	23mV	12mV

Table 4. Recommended values of  $R_{TUNE}$  and  $C_{TUNE}$  to obtain transient deviation of  $\leq 2\%$  of  $V_{out}$  for a 1A step load with  $V_{in}=5V$

$V_o$	3.3V	2.5V	1.8V	1.2V	0.6V
Co	1x47 $\mu$ F	2x47 $\mu$ F	2x47 $\mu$ F	3x47 $\mu$ F	330 $\mu$ F Polymer
$R_{TUNE}$	220	150	150	100	100
$C_{TUNE}$	3900pF	10nF	10nF	18nF	68nF
$\Delta V$	62mV	35mV	34mV	23mV	12mV

## 2A PicoTLynx™: Non-Isolated DC-DC Power Modules

3Vdc –14Vdc input; 0.6Vdc to 5.5Vdc output; 2A Output Current

**Table 5. Recommended values of  $R_{TUNE}$  and  $C_{TUNE}$  to obtain transient deviation of  $\leq 2\%$  of  $V_{out}$  for a 1A step load with  $V_{in}=3.3V$**

$V_o$	2.5V	1.8V	1.2V	0.6V
$C_o$	3x47 $\mu$ F	2x47 $\mu$ F	3x47 $\mu$ F	330 $\mu$ F Polymer
$R_{TUNE}$	100	150	100	100
$C_{TUNE}$	18nF	10nF	18nF	68nF
$\Delta V$	48mV	34mV	23mV	12mV



## 2A PicoTLynx™: Non-Isolated DC-DC Power Modules

3Vdc –14Vdc input; 0.6Vdc to 5.5Vdc output; 2A Output Current

### Thermal Considerations

Power modules operate in a variety of thermal environments; however, sufficient cooling should always be provided to help ensure reliable operation.

Considerations include ambient temperature, airflow, module power dissipation, and the need for increased reliability. A reduction in the operating temperature of the module will result in an increase in reliability. The thermal data presented here is based on physical measurements taken in a wind tunnel. The test set-up is shown in Figure 48. The preferred airflow direction for the module is in Figure 49.

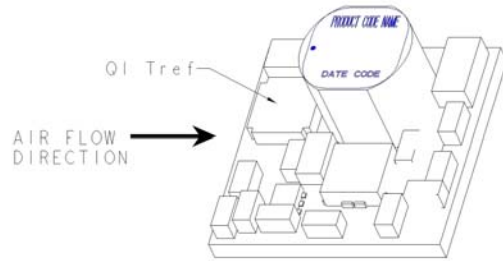

Figure 49. Preferred airflow direction and location of hot-spot of the module (Tref).

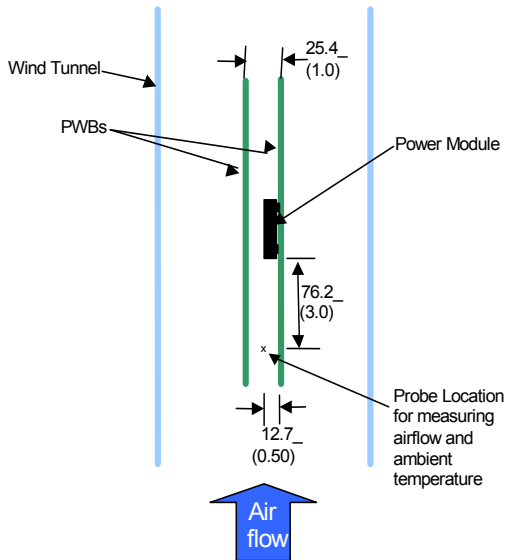

Figure 48. Thermal Test Setup.

The thermal reference points,  $T_{ref}$  used in the specifications are also shown in Figure 13. For reliable operation the temperatures at these points should not exceed 140°C. The output power of the module should not exceed the rated power of the module ( $V_{o,set} \times I_{o,max}$ ).

Please refer to the Application Note “Thermal Characterization Process For Open-Frame Board-Mounted Power Modules” for a detailed discussion of thermal aspects including maximum device temperatures.

## 2A PicoTLynx™: Non-Isolated DC-DC Power Modules

3Vdc –14Vdc input; 0.6Vdc to 5.5Vdc output; 2A Output Current

### Example Application Circuit

#### Requirements:

V <sub>in</sub> :	12V
V <sub>out</sub> :	1.8V
I <sub>out</sub> :	1A max., worst case load transient is from 1A to 1.5A
ΔV <sub>out</sub> :	1.5% of V <sub>out</sub> (27mV) for worst case load transient
V <sub>in</sub> , ripple	1.5% of V <sub>in</sub> (180mV, p-p)

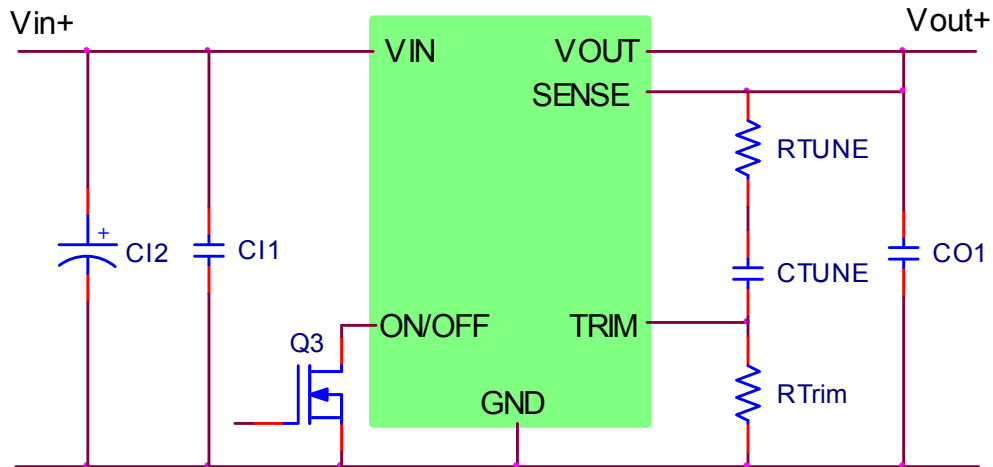

C11	1x10μF/16V ceramic capacitor (e.g. TDK C Series)
C12	100μF/16V bulk electrolytic
CO1	2x47μF/6.3V ceramic capacitor (e.g. TDK C Series, Murata GRM32ER60J476ME20)
CTune	5600pF ceramic capacitor (can be 1206, 0805 or 0603 size)
RTune	150 ohms SMT resistor (can be 1206, 0805 or 0603 size)
RTrim	5kΩ SMT resistor (can be 1206, 0805 or 0603 size, recommended tolerance of 0.1%)

# 2A PicoTLynx™: Non-Isolated DC-DC Power Modules

3Vdc –14Vdc input; 0.6Vdc to 5.5Vdc output; 2A Output Current

## Mechanical Outline

Dimensions are in millimeters and (inches).

Tolerances: x.x mm ± 0.5 mm (x.xx in. ± 0.02 in.) [unless otherwise indicated]

x.xx mm ± 0.25 mm (x.xxx in ± 0.010 in.)

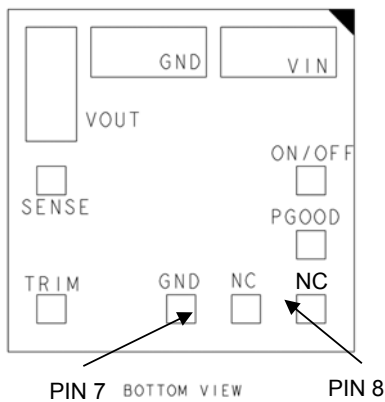
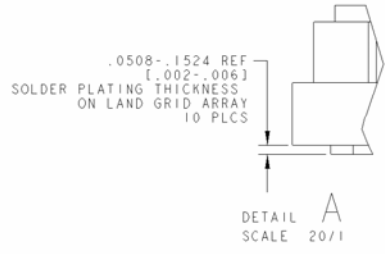
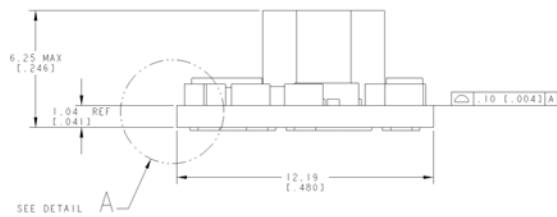
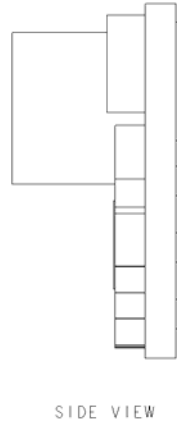
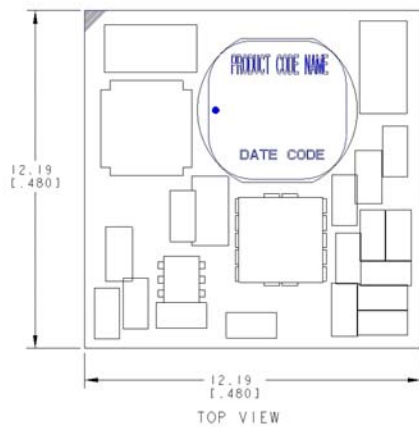

PIN	FUNCTION
1	ON/OFF
2	VIN
3	GND
4	VOUT
5	SENSE
6	TRIM
7	GND
8	NC
9	NC
10	PGOOD

# 2A PicoTLynx™: Non-Isolated DC-DC Power Modules

3Vdc –14Vdc input; 0.6Vdc to 5.5Vdc output; 2A Output Current

## Recommended Pad Layout

Dimensions are in millimeters and (inches).

Tolerances: x.x mm ± 0.5 mm (x.xx in. ± 0.02 in.) [unless otherwise indicated]

x.xxx mm ± 0.25 mm (x.xxx in ± 0.010 in.)

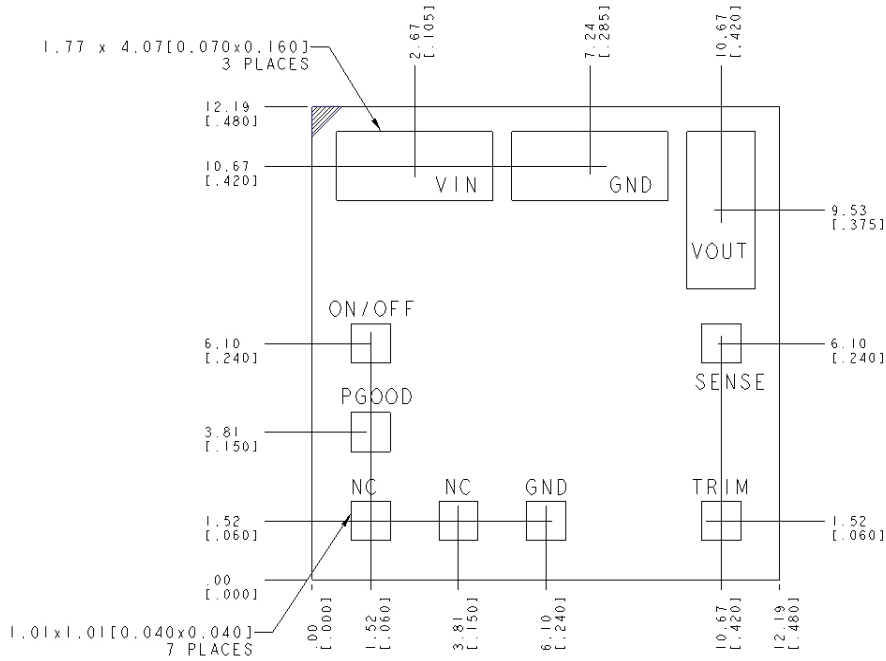

RECOMMENDED FOOTPRINT  
-THRU THE BOARD-

PIN	FUNCTION
1	ON/OFF
2	VIN
3	GND
4	VOUT
5	SENSE
6	TRIM
7	GND
8	NC
9	NC
10	PGOOD

# 2A PicoTLynx™: Non-Isolated DC-DC Power Modules

3Vdc –14Vdc input; 0.6Vdc to 5.5Vdc output; 2A Output Current

## Packaging Details

The 12V PicoTLynx™ 2A modules are supplied in tape & reel as standard. Modules are shipped in quantities of 400 modules per reel.

All Dimensions are in millimeters and (in inches).

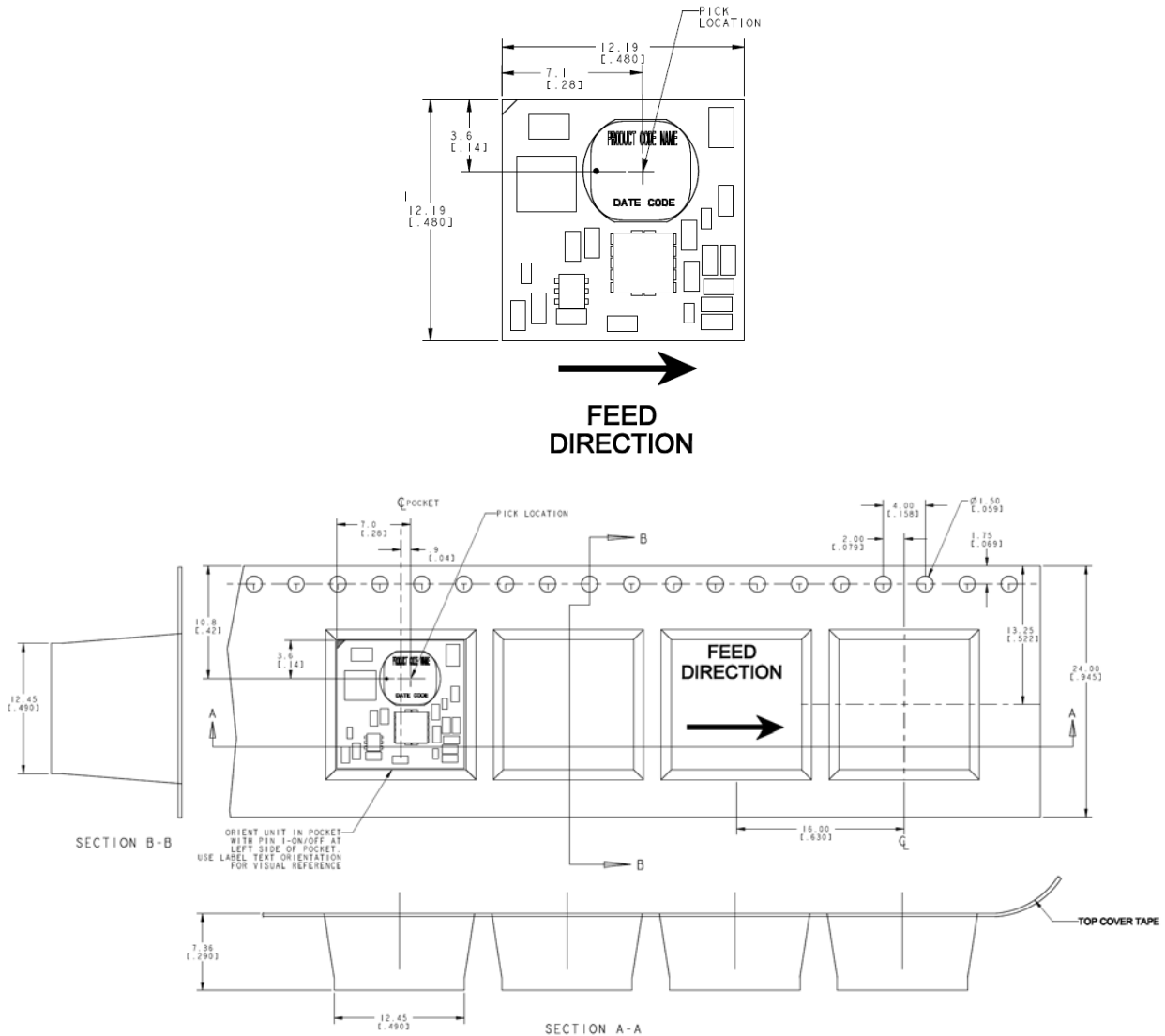

- Reel Dimensions:
- Outside Dimensions: 330.2 mm (13.00)
- Inside Dimensions: 177.8 mm (7.00")
- Tape Width: 24.00 mm (0.945")

## 2A PicoTLynx™: Non-Isolated DC-DC Power Modules

3Vdc –14Vdc input; 0.6Vdc to 5.5Vdc output; 2A Output Current

### Surface Mount Information

#### Pick and Place

The 12V PicoTLynx™ 2A modules use an open frame construction and are designed for a fully automated assembly process. The modules are fitted with a label designed to provide a large surface area for pick and place operations. The label meets all the requirements for surface mount processing, as well as safety standards, and is able to withstand reflow temperatures of up to 300°C. The label also carries product information such as product code, serial number and the location of manufacture.

#### Nozzle Recommendations

The module weight has been kept to a minimum by using open frame construction. Variables such as nozzle size, tip style, vacuum pressure and placement speed should be considered to optimize this process. The minimum recommended inside nozzle diameter for reliable operation is 3mm. The maximum nozzle outer diameter, which will safely fit within the allowable component spacing, is 7 mm.

#### Bottom Side / First Side Assembly

This module is not recommended for assembly on the bottom side of a customer board. If such an assembly is attempted, components may fall off the module during the second reflow process. If assembly on the bottom side is planned, please contact GE Critical Power for special manufacturing process instructions.

#### Lead Free Soldering

The 12V PicoTLynx™ 2A modules are lead-free (Pb-free) and RoHS compliant and fully compatible in a Pb-free soldering process. Failure to observe the instructions below may result in the failure of or cause damage to the modules and can adversely affect long-term reliability.

#### Pb-free Reflow Profile

Power Systems will comply with J-STD-020 Rev. C (Moisture/Reflow Sensitivity Classification for Nonhermetic Solid State Surface Mount Devices) for both Pb-free solder profiles and MSL classification procedures. This standard provides a recommended forced-air-convection reflow profile based on the volume and thickness of the package (table 4-2). The suggested Pb-free solder paste is Sn/Ag/Cu (SAC). A 6 mil thick stencil is recommended.

For questions regarding Land grid array(LGA) soldering, solder volume; please contact GE Critical Power for special manufacturing process instructions.

The recommended linear reflow profile using Sn/Ag/Cu solder is shown in Fig. 50. Soldering outside of the recommended profile requires testing to verify results and performance.

#### MSL Rating

The 12V PicoTLynx™ 2A modules have a MSL rating of 2a.

### Storage and Handling

The recommended storage environment and handling procedures for moisture-sensitive surface mount packages is detailed in J-STD-033 Rev. A (Handling, Packing, Shipping and Use of Moisture/Reflow Sensitive Surface Mount Devices). Moisture barrier bags (MBB) with desiccant are required for MSL ratings of 2 or greater. These sealed packages should not be broken until time of use. Once the original package is broken, the floor life of the product at conditions of  $\leq 30^{\circ}\text{C}$  and 60% relative humidity varies according to the MSL rating (see J-STD-033A). The shelf life for dry packed SMT packages will be a minimum of 12 months from the bag seal date, when stored at the following conditions:  $< 40^{\circ}\text{C}$ ,  $< 90\%$  relative humidity.

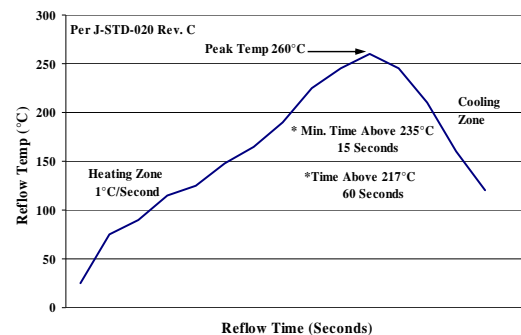

Figure 50. Recommended linear reflow profile using Sn/Ag/Cu solder.

### Post Solder Cleaning and Drying Considerations

Post solder cleaning is usually the final circuit-board assembly process prior to electrical board testing. The result of inadequate cleaning and drying can affect both the reliability of a power module and the testability of the finished circuit-board assembly. For guidance on appropriate soldering, cleaning and drying procedures, refer to *Board Mounted Power Modules: Soldering and Cleaning Application Note (AN04-001)*.

## 2A PicoTLynx™: Non-Isolated DC-DC Power Modules

3Vdc –14Vdc input; 0.6Vdc to 5.5Vdc output; 2A Output Current

### Ordering Information

Please contact your GE Critical Power Sales Representative for pricing, availability and optional features.

**Table 8. Device Codes**

Device Code	Input Voltage Range	Output Voltage	Output Current	On/Off Logic	Sequencing	Comcodes
APXS002A0X-SRZ	3 – 14Vdc	0.6 – 5.5Vdc	2A	Negative	No	CC109150406

**\* Special codes, consult factory before ordering**

**Table 9. Coding Scheme**

TLynx family	Sequencing feature.	Input voltage range	Output current	Output voltage	On/Off logic	Options	ROHS Compliance
AP	X	S	002A0	X		-SR	Z
	X = w/o Seq.	S = 3 - 14V	2.0A	X = programmable output	4 = positive No entry = negative 4 = positive	S = Surface Mount R = Tape&Reel	Z = ROHS6

## Contact Us

For more information, call us at

USA/Canada:

**+1 877 546 3243**, or +1 972 244 9288

Asia-Pacific:

+86.021.54279977\*808

Europe, Middle-East and Africa:

+49.89.878067-280

[www.gecriticalpower.com](http://www.gecriticalpower.com)



GE Critical Power reserves the right to make changes to the product(s) or information contained herein without notice, and no liability is assumed as a result of their use or application. No rights under any patent accompany the sale of any such product(s) or information.

单击下面可查看定价，库存，交付和生命周期等信息

[>>ABB](#)