

AUTOMOTIVE GRADE SHIELDED SMD POWER INDUCTOR



ASPIAIG-S4035

4.0 x 4.0 x 3.5 mm
MSL = 1

RoHS/RoHS II Compliant

FEATURES

- TS-16949 qualified production
- PPAP level 3 support
- AEC-Q200 qualified with -40°C to 125°C operation
- High reliability wire-wound construction
- Shielded construction reduces EMI
- High inductance up to 150µH
- Low DCR down to 2.28 mΩ

APPLICATIONS

- Automotive body electronics and comfort system
- Automotive infotainment and entertainment
- Automotive navigation
- Industrial Internet of Things (IIoT)
- Industrial applications
- Applications requiring high inductance value
- Transportation
- Lighting, LED ballasts
- Solar power
- DC/DC converters and switch mode power supplies

OPTIONS AND PART IDENTIFICATION

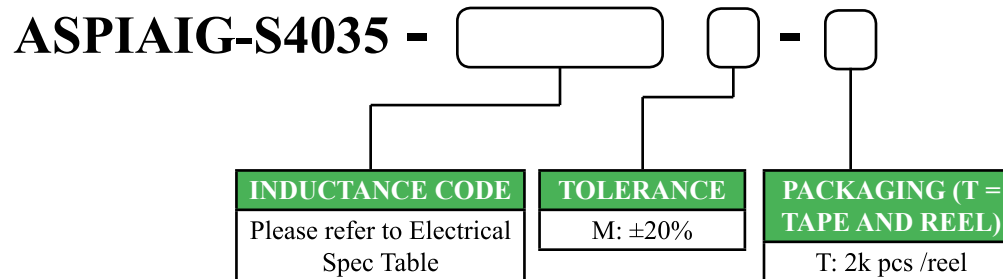

ELECTRICAL SPECIFICATIONS

OPERATING TEMPERATURE -40°C ~ +125°C	STORAGE CONDITION -10°C ~ +40°C and R.H. 70% max
--	--

PART NUMBER	INDUCTANCE	TOLERANCE	SELF-RESONANT FREQUENCY	DC RESISTANCE	SATURATION CURRENT	TEMPERATURE RISE CURRENT
	0.1MHz/0.1V		Min	Max	Max	Typ
UNITS	µH	%	MHz	Ω	A	A
SYMBOL	L	M	SRF	DCR	Isat	Irms
ASPIAIG-S4035-1R0	1.0	M	121	0.024	6.90	4.50
ASPIAIG-S4035-1R2	1.2	M	70	0.028	6.70	4.20
ASPIAIG-S4035-1R5	1.5	M	60	0.030	6.10	3.90
ASPIAIG-S4035-1R8	1.8	M	52	0.034	5.50	3.70
ASPIAIG-S4035-2R2	2.2	M	52	0.040	4.80	3.50
ASPIAIG-S4035-3R3	3.3	M	38	0.058	3.80	2.90
ASPIAIG-S4035-4R7	4.7	M	31	0.082	3.20	2.45
ASPIAIG-S4035-6R8	6.8	M	24	0.101	2.80	2.20
ASPIAIG-S4035-8R2	8.2	M	26	0.112	2.40	2.10
ASPIAIG-S4035-100	10	M	21	0.14	2.30	1.85
ASPIAIG-S4035-150	15	M	16	0.23	1.80	1.45
ASPIAIG-S4035-220	22	M	10	0.29	1.50	1.30
ASPIAIG-S4035-330	33	M	10	0.42	1.30	1.05
ASPIAIG-S4035-470	47	M	8.4	0.59	1.05	0.90
ASPIAIG-S4035-680	68	M	7.0	1.09	0.85	0.65
ASPIAIG-S4035-101	100	M	5.6	1.38	0.75	0.55
ASPIAIG-S4035-151	150	M	4.0	2.28	0.55	0.45

REVISED: 10.31.2018



1501 Hidden Creek Lane Spicewood TX 78751
Phone: 512-371-6159 | Fax: 512-351-8858
For terms and conditions of sales visit:
www.abracon.com

ABRACON IS
ISO9001-2015
CERTIFIED

AUTOMOTIVE GRADE SHIELDED SMD POWER INDUCTOR



ASPIAIG-S4035

4.0 x 4.0 x 3.5 mm
MSL = 1

RoHS/RoHS II Compliant

ELECTRICAL CHARACTERISTICS

ASPIAIG-S4035-1R0

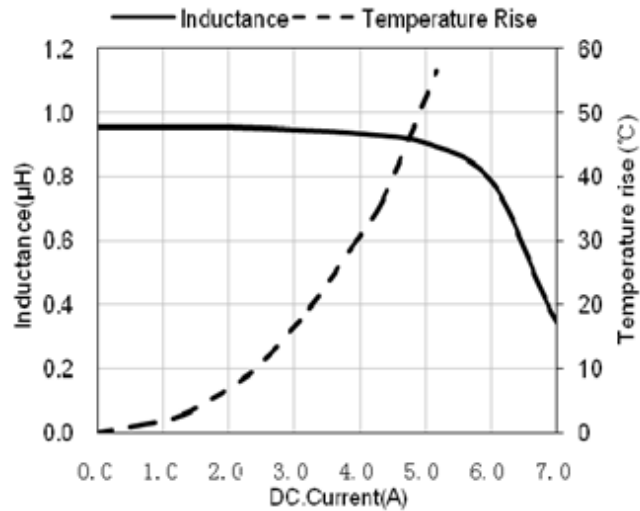

ASPIAIG-S4035-1R2

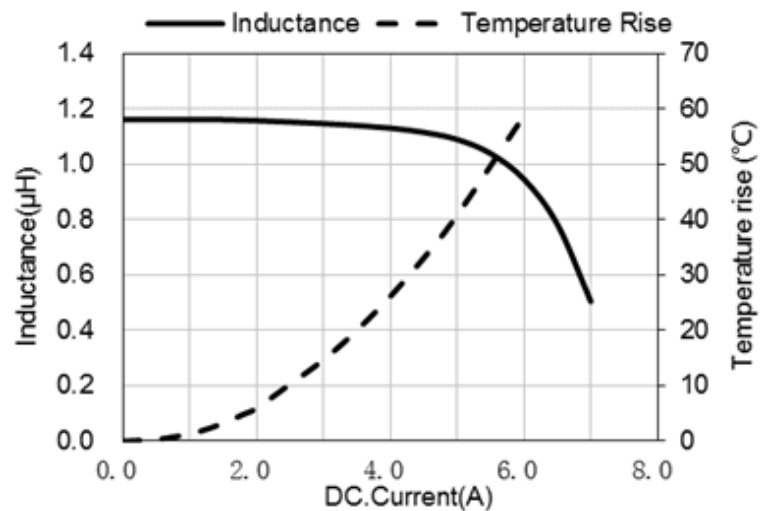

ASPIAIG-S4035-1R5

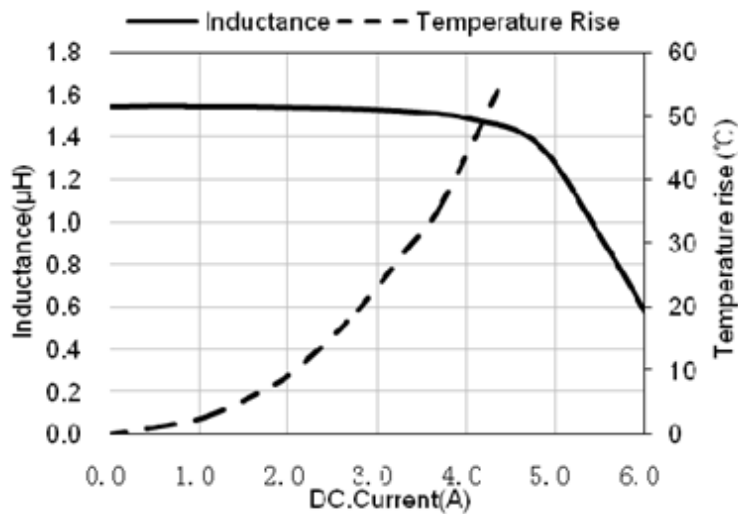

ASPIAIG-S4035-1R8

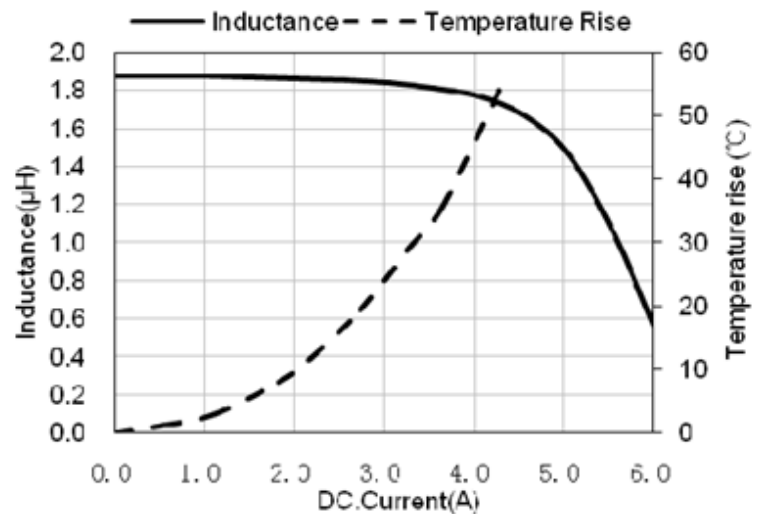

ASPIAIG-S4035-2R2

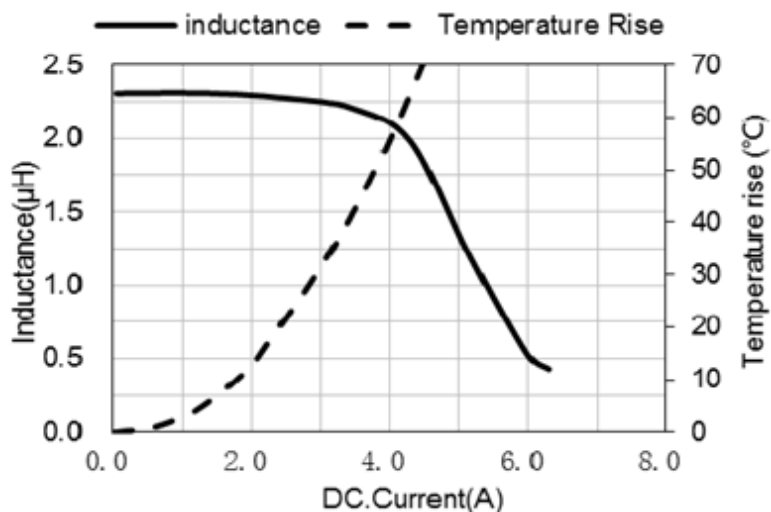

ASPIAIG-S4035-3R3

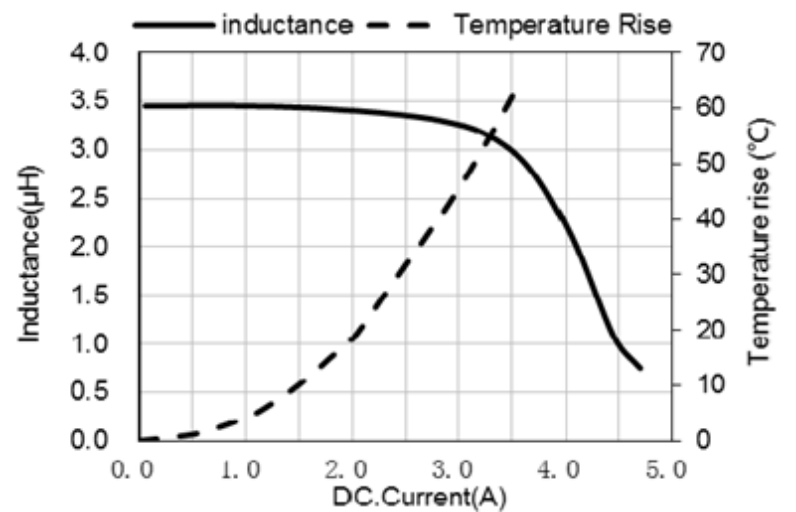

1501 Hidden Creek Lane Spicewood TX 78751
Phone: 512-371-6159 | Fax: 512-351-8858
For terms and conditions of sales visit:
www.abracon.com

REVISED: 10.31.2018

ABRACON IS
ISO9001-2015
CERTIFIED

AUTOMOTIVE GRADE SHIELDED SMD POWER INDUCTOR



ASPIAIG-S4035

4.0 x 4.0 x 3.5 mm
MSL = 1

RoHS/RoHS II Compliant

ELECTRICAL CHARACTERISTICS

ASPIAIG-S4035-4R7

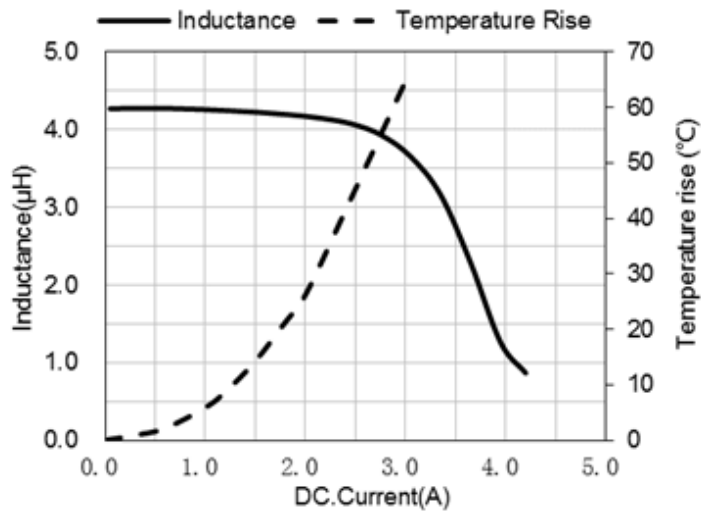

ASPIAIG-S4035-6R8

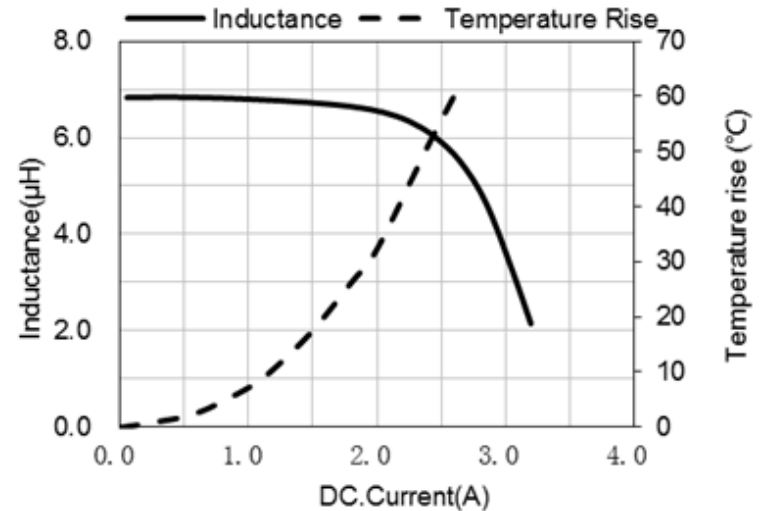

ASPIAIG-S4035-8R2

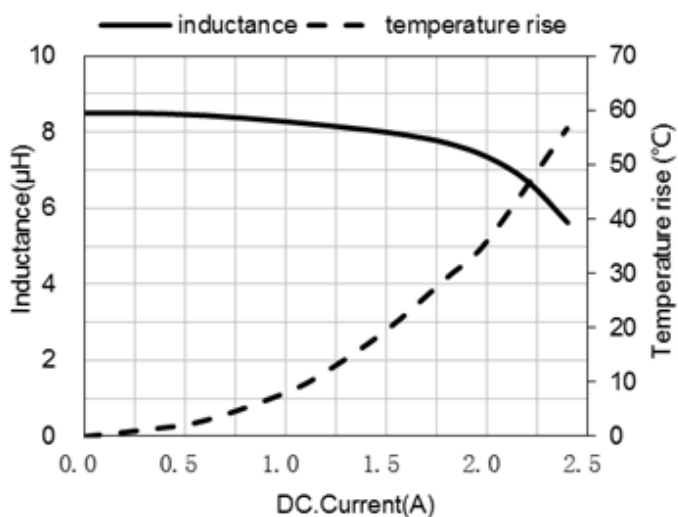

ASPIAIG-S4035-100

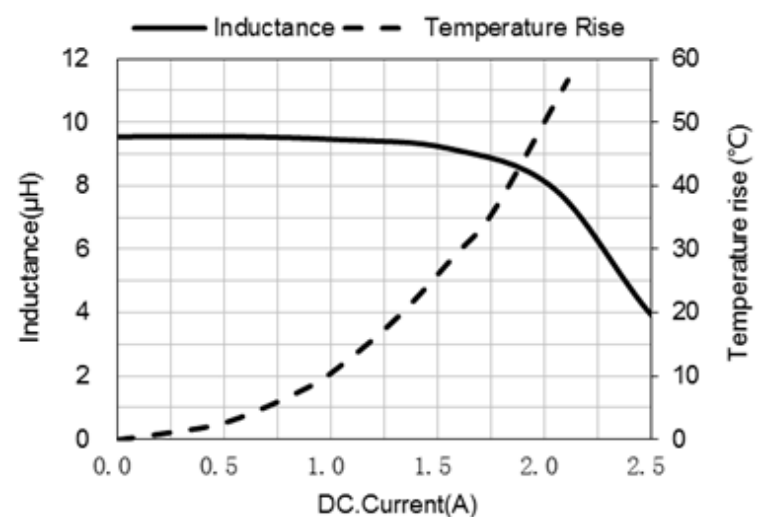

ASPIAIG-S4035-150

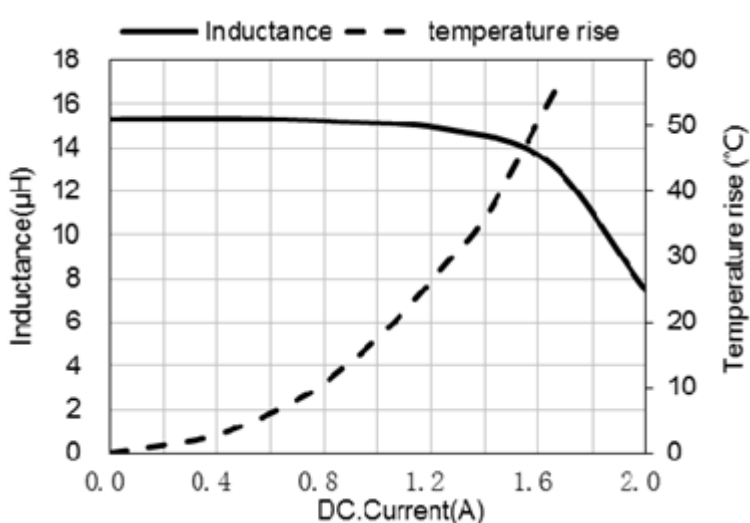

ASPIAIG-S4035-220

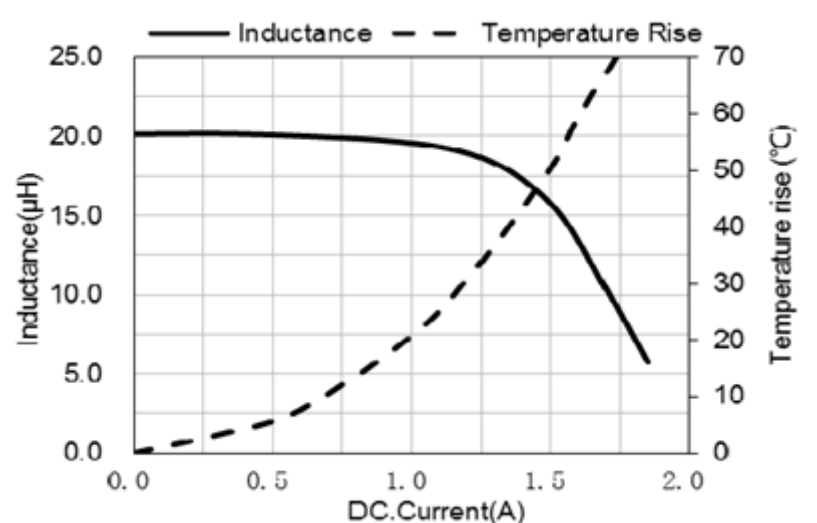

1501 Hidden Creek Lane Spicewood TX 78751
Phone: 512-371-6159 | Fax: 512-351-8858
For terms and conditions of sales visit:
www.abracon.com

REVISED: 10.31.2018

ABRACON IS
ISO9001-2015
CERTIFIED

AUTOMOTIVE GRADE SHIELDED SMD POWER INDUCTOR



ASPIAIG-S4035

4.0 x 4.0 x 3.5 mm
MSL = 1

RoHS/RoHS II Compliant

ELECTRICAL CHARACTERISTICS

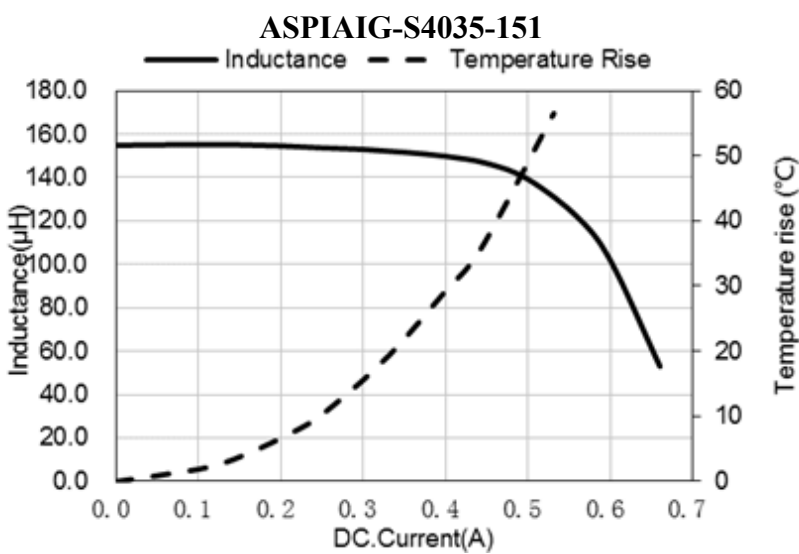
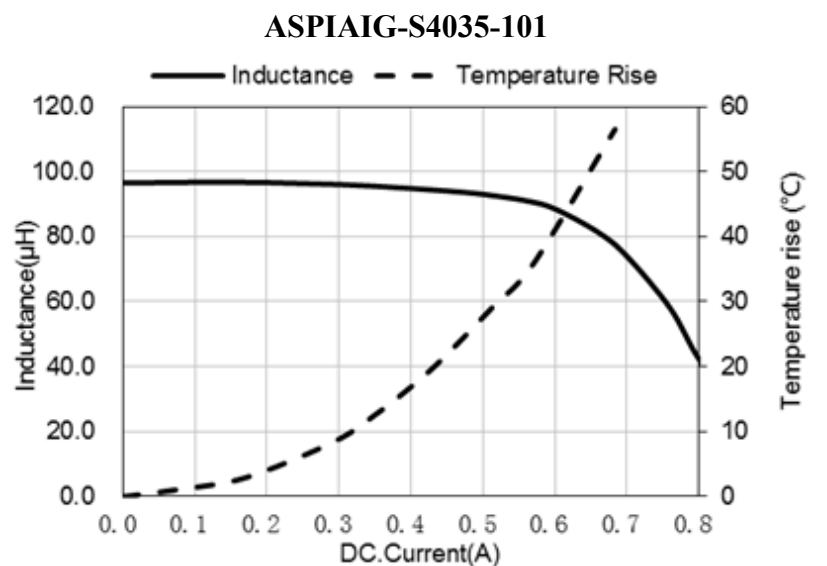
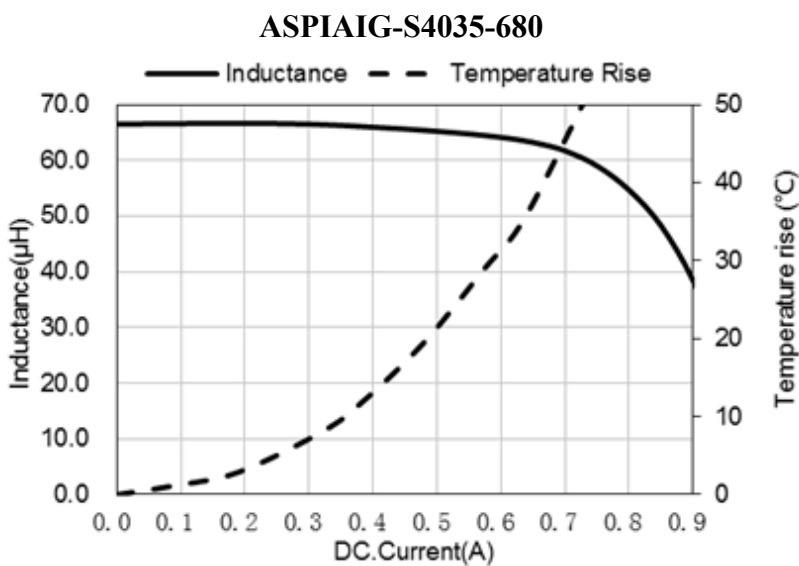
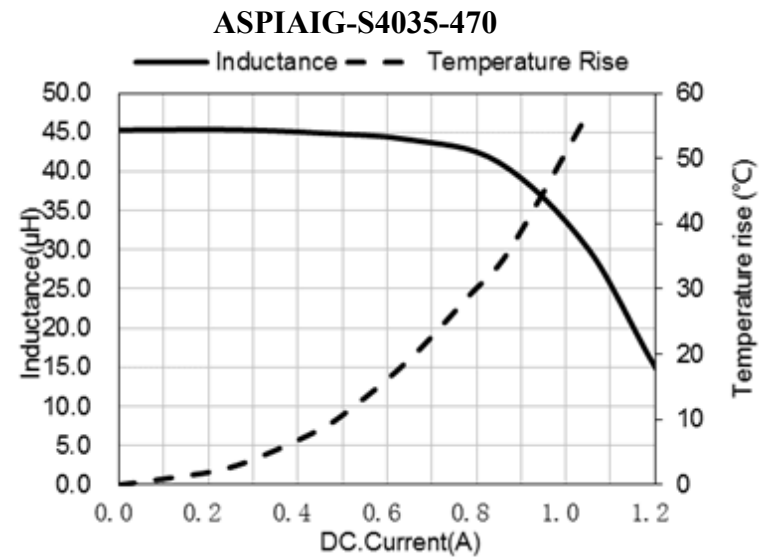
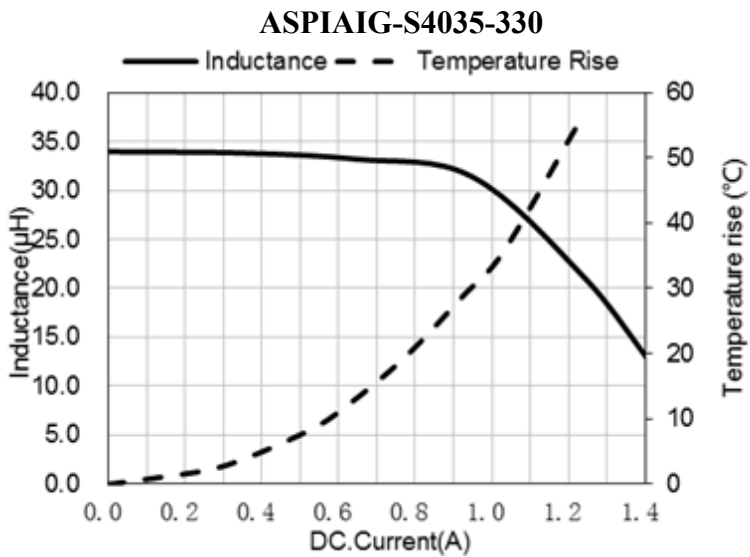

1501 Hidden Creek Lane Spicewood TX 78751
 Phone: 512-371-6159 | Fax: 512-351-8858
 For terms and conditions of sales visit:
www.abracon.com

REVISED: 10.31.2018

ABRACON IS
 ISO9001-2015
 CERTIFIED

AUTOMOTIVE GRADE SHIELDED SMD POWER INDUCTOR



ASPIAIG-S4035

4.0 x 4.0 x 3.5 mm
MSL = 1

RoHS/RoHS II Compliant

MECHANICAL DIMENSIONS

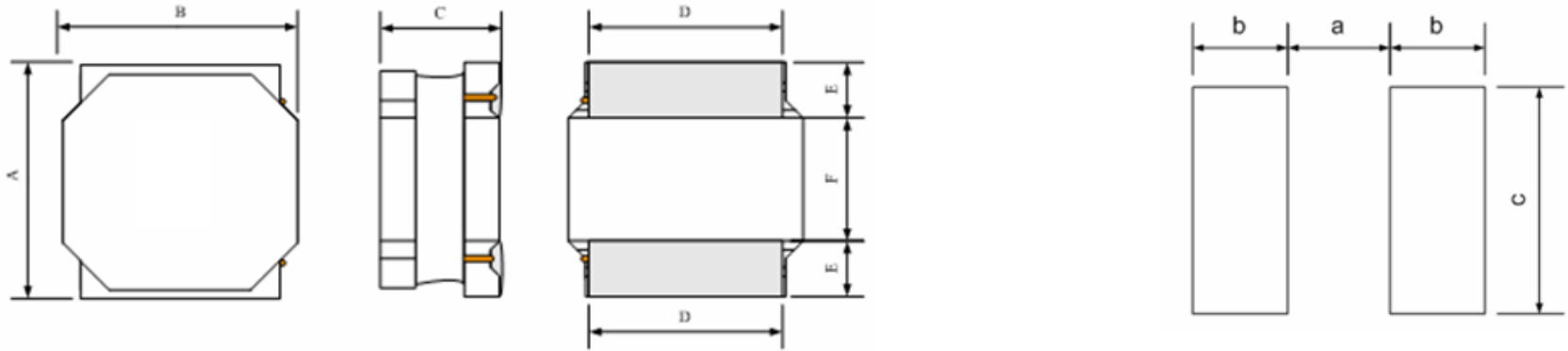

SERIES	A	B	C	D	E
ASPIAIG-S4035	4.0 ± 0.2	4.0 ± 0.2	3.5 ± 0.2	3.2 ± 0.1	0.95 ± 0.1

A TYP	B TYP	C TYP
1.9	1.1	3.7

Dimension: mm

REFLOW

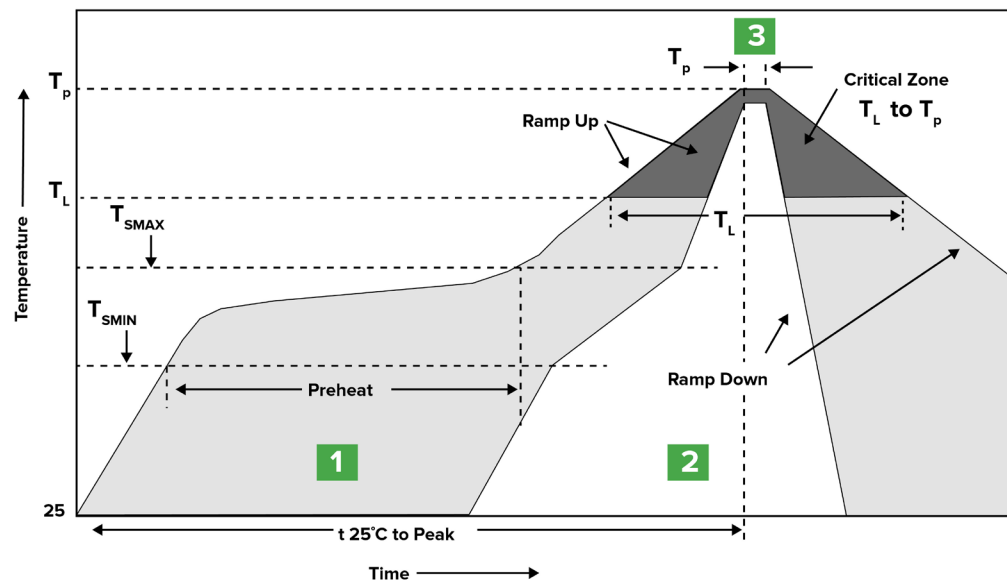

Zone	Description	Temperature	Times
1	Preheat	$T_{SMIN} \sim T_{SMAX}$ 150°C ~ 200°C	60 ~ 120 sec.
2	Reflow	T_L 217°C	60 ~ 90 sec.
3	Peak heat	T_P 260°C	5 sec. MAX



1501 Hidden Creek Lane Spicewood TX 78751
Phone: 512-371-6159 | Fax: 512-351-8858
For terms and conditions of sales visit:
www.abracon.com

REVISED: 10.31.2018

ABRACON IS
ISO9001-2015
CERTIFIED

AUTOMOTIVE GRADE SHIELDED SMD POWER INDUCTOR



ASPIAIG-S4035

4.0 x 4.0 x 3.5 mm
MSL = 1

 RoHS/RoHS II Compliant

PACKING (TAPE & REEL: 2000 PCS/REEL)

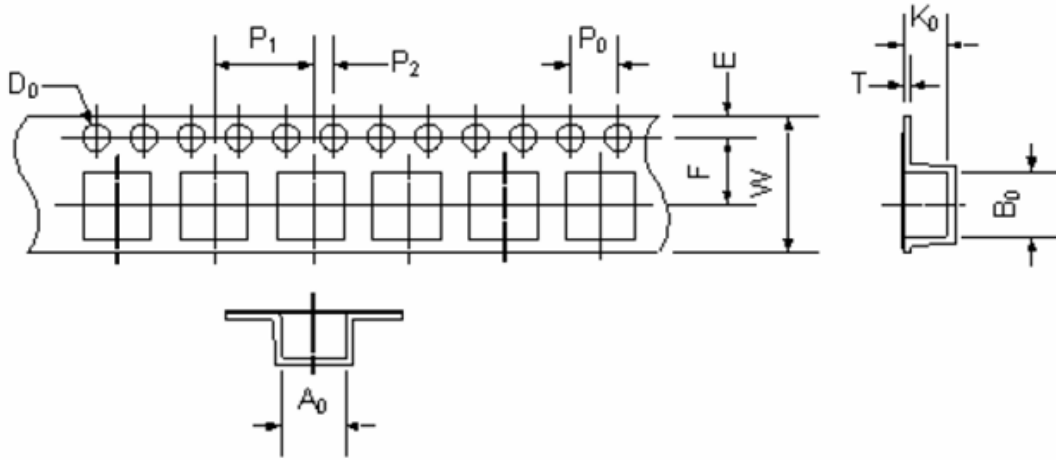

W	E	F	P ₀	P ₁	P ₂	D ₀	A ₀	B ₀	T	K ₀
12.0±0.3	1.75±0.1	5.5±0.1	4.0±0.1	8.0±0.1	2.0±0.1	1.5+0.1/-0.0	4.3±0.1	4.3±0.1	0.40±0.05	3.7±0.1

DIRECTION OF ROLLING

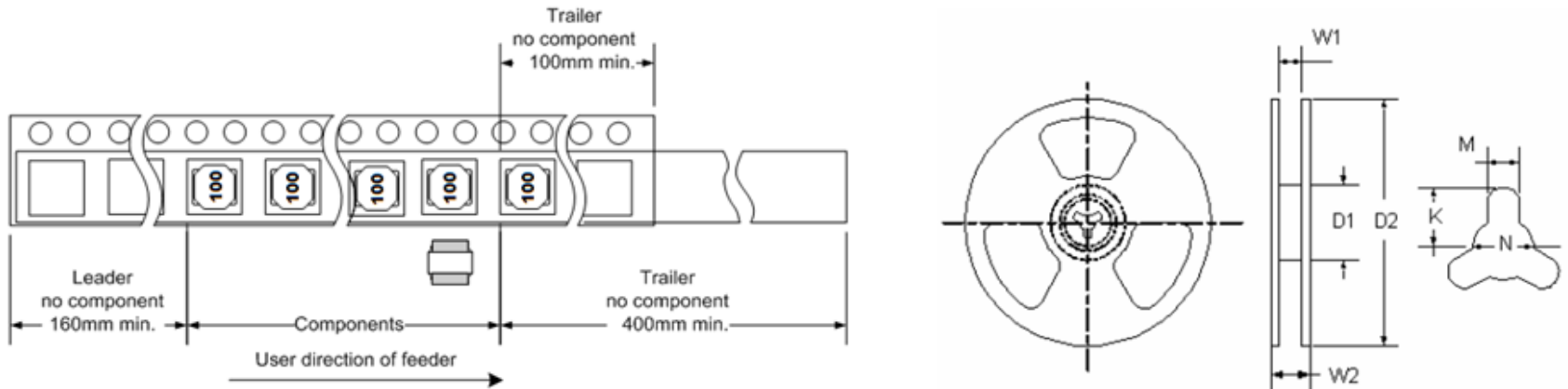

D1	100 ± 0.5
D2	330 ± 0.1
W1	16.4 +0.2 / -0.0
W2	22.4 MAX
K	10.75 ± 0.2
M	2.3 ± 0.2
N	13.0 +0.2 / -0.0

Dimension: mm



1501 Hidden Creek Lane Spicewood TX 78751
Phone: 512-371-6159 | Fax: 512-351-8858
For terms and conditions of sales visit:
www.abracon.com

REVISED: 10.31.2018

ABRACON IS
ISO9001-2015
CERTIFIED

单击下面可查看定价，库存，交付和生命周期等信息

[>>ABRACON](#)