

- NOTES:
- MATERIAL:
 - 1.1 HOUSING: THERMOPLASTIC
 - 1.2 CONTACT: COPPER ALLOY
 - FINISH:
 - 2.1 CONTACT:
 - 50u" MIN. NICKEL UNDERPLATING OVERALL
 - N: 100u" MIN MATTE TIN OVERALL
 - C: 15u" GOLD PLATING OVERALL
 - SPEC. PLS. REFER TO PS-57955-XXXXX-XXX
 - PACKAGE PLS. REFER TO 57955-XXXXX-XX-TRP 57955-TB

5. PART NUMBER
57955-XXX X X-XXX

XXX	Type	Housing Material & Color	Flammability
001	With Mounting peg	Lcp & Black	UL94-V0

NO OF CKT
PACKING
0:TAPE & REEL
1:TUBE
PLATING
N: MATT TIN
C: 15u" GOLD

CKT	DIM A	DIM B
2	5.4	NA
4	9.6	4.2
6	13.8	8.4
8	18.0	12.6
10	22.2	16.8
12	26.4	21.0
14	30.6	25.2
16	34.8	29.4
18	39.0	33.6
20	43.2	37.8
22	47.4	42.0
24	51.6	46.2

QUALITY SYMBOLS MAJOR CRITICAL GENERAL TOLERANCES (UNLESS SPECIFIED) X. ±0.5 .X ±0.25 .XX ±0.15 .XXX ±0.1 ANGLES ±2°	DRAWN BY Tang,En Hui DATE 19/07/30	ACES ELECTRONICS TITLE 4.2mm PITCH HEADER CONN. T/H D/R R/A TYPE
	CHECKED BY Lu,Jing Quan DATE 19/07/30	
UNITS mm	SCALE 2:1	SIZE A4
SHEET NO. 1 OF 6	REV B	RFG NO. N/A
DWG NO. 57955-XXXXX-XXX		

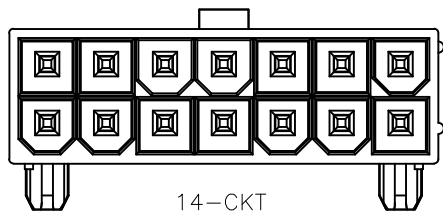

14-CKT

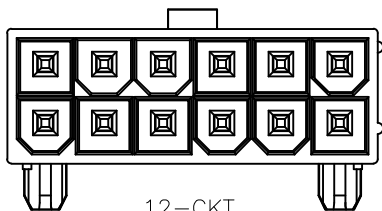

12-CKT

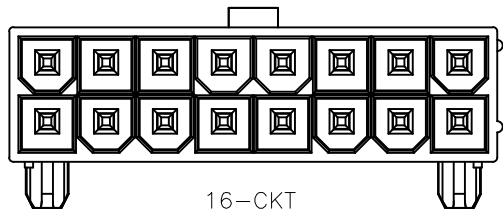

16-CKT

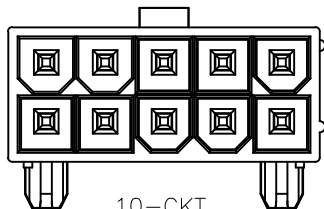

10-CKT

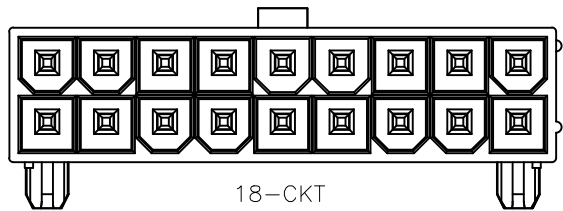

18-CKT

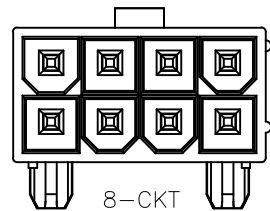

8-CKT

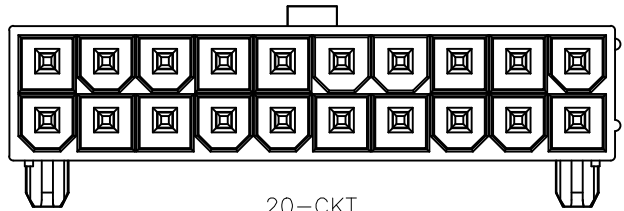

20-CKT

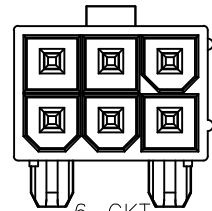

6-CKT

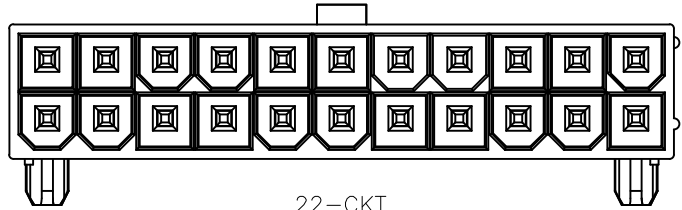

22-CKT

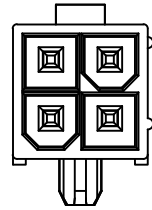

4-CKT

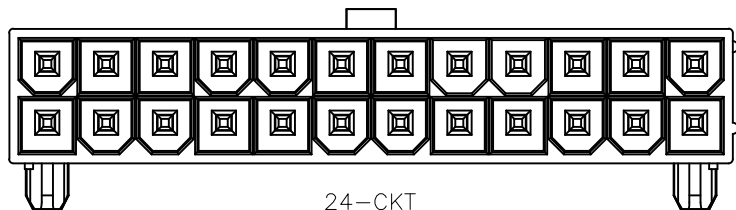

24-CKT

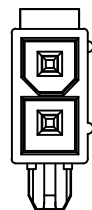

2-CKT

QUALITY SYMBOLS MAJOR CRITICAL GENERAL TOLERANCES (UNLESS SPECIFIED) X. ±0.5 .X ±0.25 .XX ±0.15 .XXX ±0.1 ANGLES ±2°	DRAWN BY Tang,En Hui	DATE 19/07/30	
	CHECKED BY Lu,Jing Quan	DATE 19/07/30	
	APPROVED BY hsieh,fu yu	DATE 19/07/30	RFG NO. N/A
	UNITS mm		SIZE A4
	SCALE 2 : 1	SHEET NO. 2 OF 6	REV B
			DWG NO. 57955-XXXX-XXX

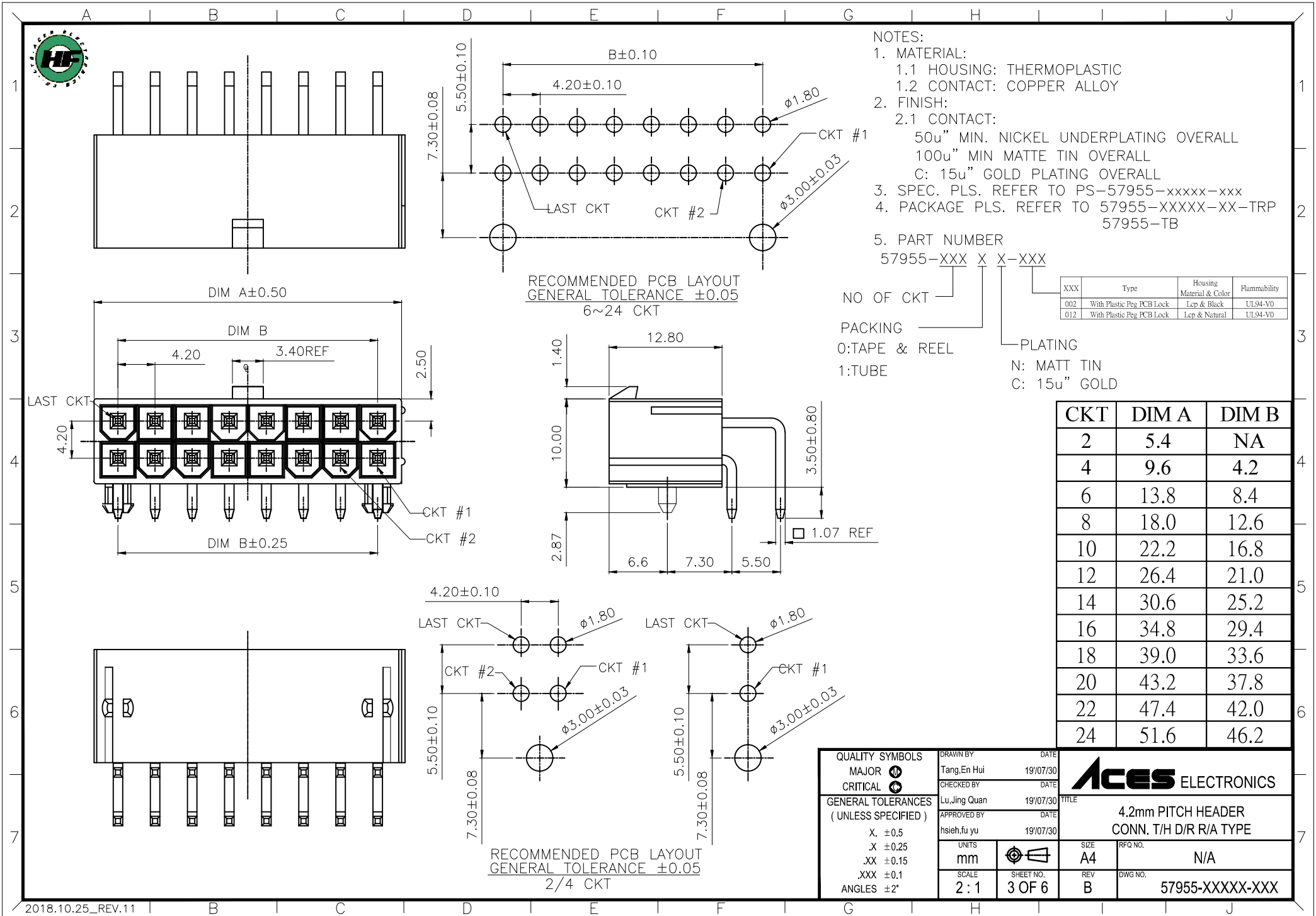

- NOTES:
- MATERIAL:
 - HOUSING: THERMOPLASTIC
 - CONTACT: COPPER ALLOY
 - FINISH:
 - CONTACT:
 - 50u" MIN. NICKEL UNDERPLATING OVERALL
 - 100u" MIN MATTE TIN OVERALL
 - C: 15u" GOLD PLATING OVERALL
 - SPEC. PLS. REFER TO PS-57955-xxxxx-xxx
 - PACKAGE PLS. REFER TO 57955-XXXXX-XX-TRP 57955-TB

5. PART NUMBER
57955-XXX X X-XXX

NO OF CKT
PACKING
0:TAPE & REEL
1:TUBE

XXX	Type	Housing Material & Color	Flammability
002	With Plastic Peg PCB Lock	Lcp & Black	UL94-V0
012	With Plastic Peg PCB Lock	Len & Natural	UL94-V0

PLATING
N: MATT TIN
C: 15u" GOLD

CKT	DIM A	DIM B
2	5.4	NA
4	9.6	4.2
6	13.8	8.4
8	18.0	12.6
10	22.2	16.8
12	26.4	21.0
14	30.6	25.2
16	34.8	29.4
18	39.0	33.6
20	43.2	37.8
22	47.4	42.0
24	51.6	46.2

RECOMMENDED PCB LAYOUT
GENERAL TOLERANCE ±0.05
6~24 CKT

RECOMMENDED PCB LAYOUT
GENERAL TOLERANCE ±0.05
2/4 CKT

QUALITY SYMBOLS MAJOR CRITICAL GENERAL TOLERANCES (UNLESS SPECIFIED) X. ±0.5 .X ±0.25 .XX ±0.15 .XXX ±0.1 ANGLES ±2°	DRAWN BY Tang,En Hui DATE 19/07/30	
	CHECKED BY Lu,Jing Qian DATE 19/07/30	
APPROVED BY hsieh,fu yu DATE 19/07/30	UNITS mm	SIZE A4
SCALE 2:1	SHEET NO. 3 OF 6	REV B
		RFG NO. N/A
		DWG NO. 57955-XXXXX-XXX

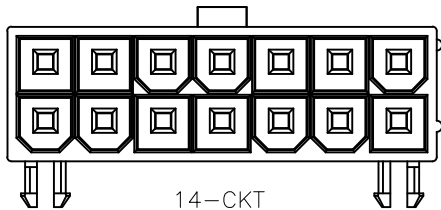

14-CKT

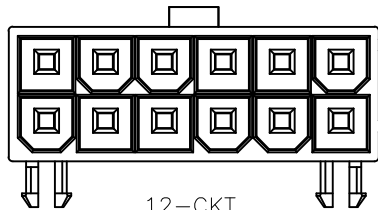

12-CKT

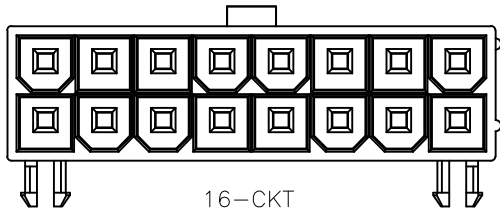

16-CKT

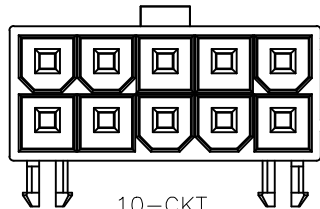

10-CKT

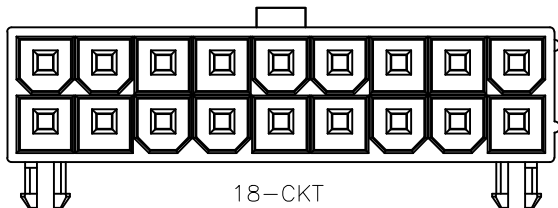

18-CKT

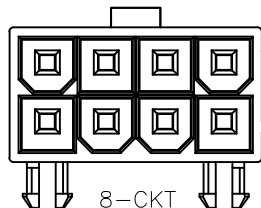

8-CKT

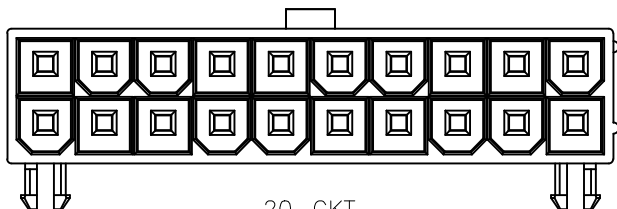

20-CKT

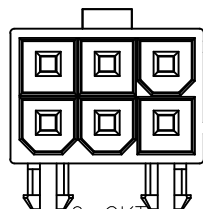

6-CKT

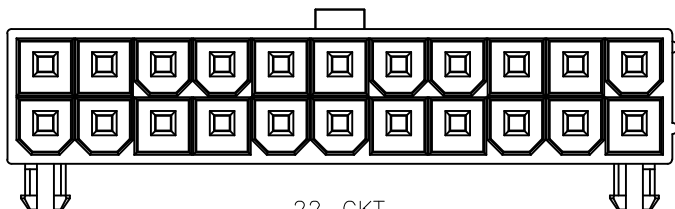

22-CKT

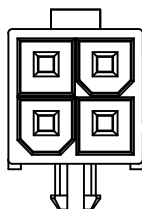

4-CKT

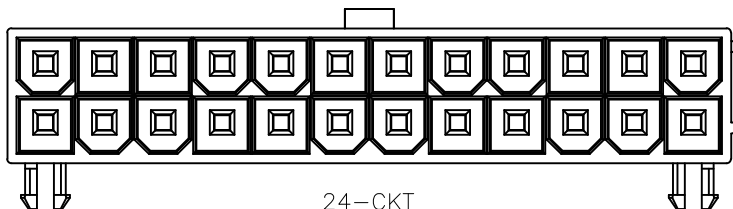

24-CKT

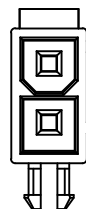

2-CKT

QUALITY SYMBOLS MAJOR CRITICAL GENERAL TOLERANCES (UNLESS SPECIFIED) X. ±0.5 .X ±0.25 .XX ±0.15 .XXX ±0.1 ANGLES ±2°	DRAWN BY Tang,En Hui	DATE 19/07/30		TITLE 4.2mm PITCH HEADER CONN. T/H D/R R/A TYPE
	CHECKED BY Lu,Jing Quan	DATE 19/07/30		
	APPROVED BY hsieh,fu yu	DATE 19/07/30	SCALE 2:1	SHEET NO. 4 OF 6
			REV B	DWG NO. 57955-XXXX-XXX



- NOTES:
- MATERIAL:
 - HOUSING: THERMOPLASTIC
 - CONTACT: COPPER ALLOY
 - FINISH:
 - CONTACT:
 - 50u" MIN. NICKEL UNDERPLATING OVERALL
 - 100u" MIN MATTE TIN OVERALL
 - C: 15u" GOLD PLATING OVERALL
 - SPEC. PLS. REFER TO PS-57955-xxxxx-xxx
 - PACKAGE PLS. REFER TO 57955-XXXXX-XX-TRP 57955-TB

5. PART NUMBER
57955-XXX X X-XXX

NO OF CKT
PACKING
0:TAPE & REEL
1:TUBE

XXX	Type	Housing Material & Color	Flammability
003	Without Plastic Peg PCB Lock	Lcp & Black	UL94-V0
013	Without Plastic Peg PCB Lock	Len & Natural	UL94-V0

PLATING
N: MATT TIN
C: 15u" GOLD

CKT	DIM A	DIM B
2	5.4	NA
4	9.6	4.2
6	13.8	8.4
8	18.0	12.6
10	22.2	16.8
12	26.4	21.0
14	30.6	25.2
16	34.8	29.4
18	39.0	33.6
20	43.2	37.8
22	47.4	42.0
24	51.6	46.2

RECOMMENDED PCB LAYOUT
GENERAL TOLERANCE ±0.05
2~24 CKT

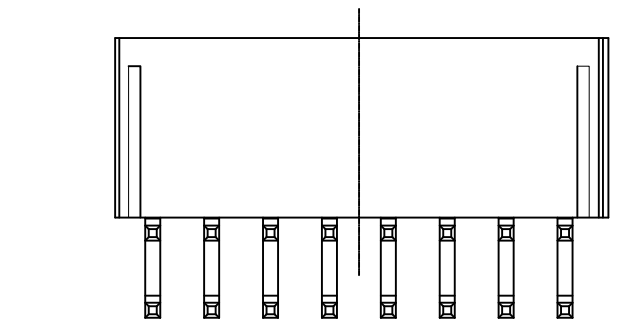
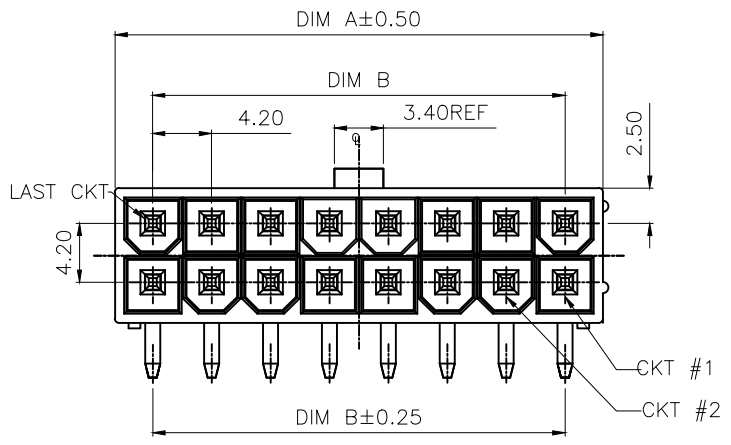
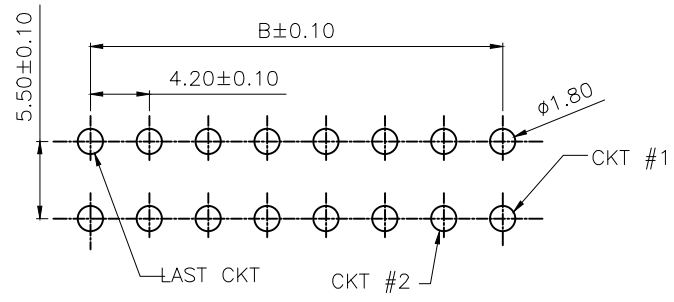
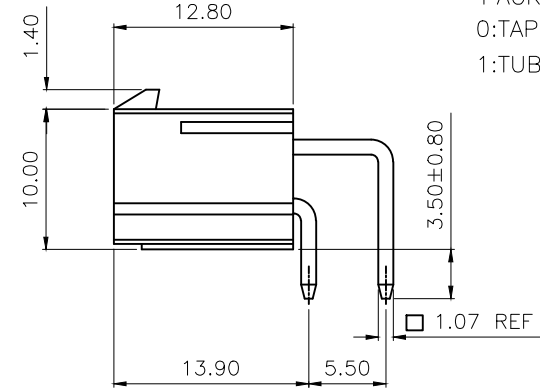

QUALITY SYMBOLS MAJOR CRITICAL GENERAL TOLERANCES (UNLESS SPECIFIED) X. ±0.5 .X ±0.25 .XX ±0.15 .XXX ±0.1 ANGLES ±2°	DRAWN BY Tang,En Hui DATE 19/07/30		TITLE 4.2mm PITCH HEADER CONN. T/H D/R R/A TYPE
	CHECKED BY Lu,Jing Quan DATE 19/07/30		
APPROVED BY hsieh,fu yu DATE 19/07/30	UNITS mm	SIZE A4	DWG NO. 57955-XXXXX-XXX
	SCALE 2:1		

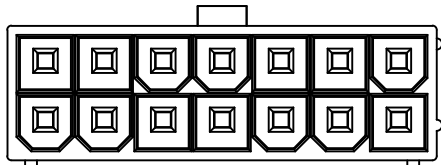

14-CKT

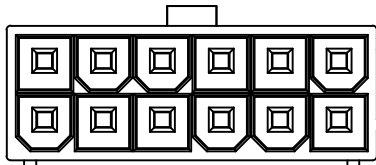

12-CKT

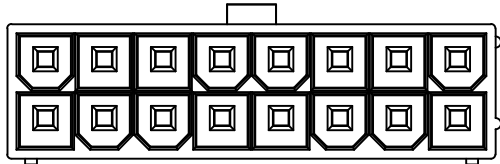

16-CKT

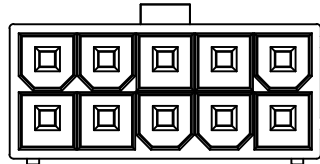

10-CKT

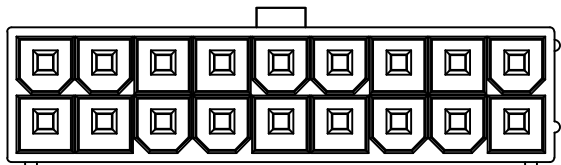

18-CKT

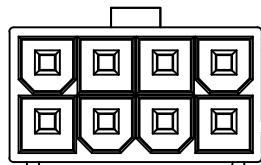

8-CKT

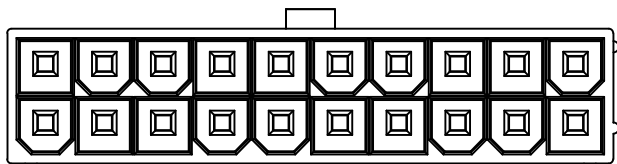

20-CKT

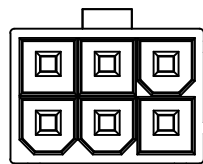

6-CKT

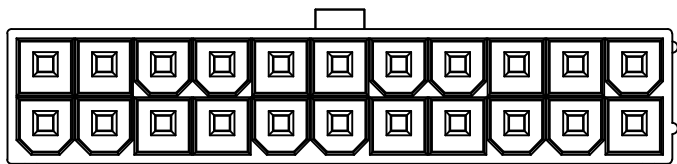

22-CKT

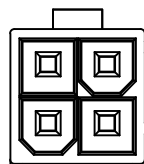

4-CKT

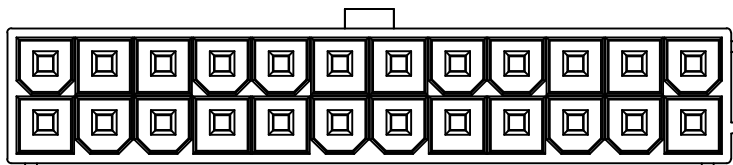

24-CKT



2-CKT

QUALITY SYMBOLS MAJOR CRITICAL GENERAL TOLERANCES (UNLESS SPECIFIED) X. ±0.5 .X ±0.25 .XX ±0.15 .XXX ±0.1 ANGLES ±2°	DRAWN BY Tang,En Hui	DATE 19/07/30		TITLE 4.2mm PITCH HEADER CONN. T/H D/R R/A TYPE		
	CHECKED BY Lu,Jing Quan	DATE 19/07/30			UNITS mm	SIZE A4
	APPROVED BY hsieh,fu yu	DATE 19/07/30	SCALE 2 : 1	SHEET NO. 6 OF 6	REV B	DWG NO. 57955-XXXXX-XXX

单击下面可查看定价，库存，交付和生命周期等信息

[>>ACES\(宏致\)](#)