

NOTES:

1. MATERIAL:
  - 1.1 HOUSING: THERMOPLASTIC, HIGH TEMP.UL94V-0; COLOR:WHITE.
  - 1.2 ACTUATOR: THERMOPLASTIC, HIGH TEMP.UL94 HB; COLOR:BLACK.
  - 1.3 CONTACT: COPPER ALLOY
  - 1.4 FITTING NAIL: COPPER ALLOY
2. FINISH:
  - 2.1 CONTACT:
    - M: 50~120u" NICKEL PLATING OVERALL
    - 3u" MIN. GOLD PLATING ON CONTACT
    - 1u" MIN. PLATING GOLD FLASH ON SMT
  - 2.2 FITTING NAIL:
    - 100~200u" MATT TIN PLATING ON SOLDER TAILS(LEAD FREE).
    - 50~100u" NICKEL UNDERPLATING OVERALL.
3. SPEC. PLS. REFER TO PS-51511-XXXX-001
4. PACKAGE PLS. REFER TO 51515-XXXX-XX-TRP/51515-XXXX-04-TRP
5. PART NUMBER

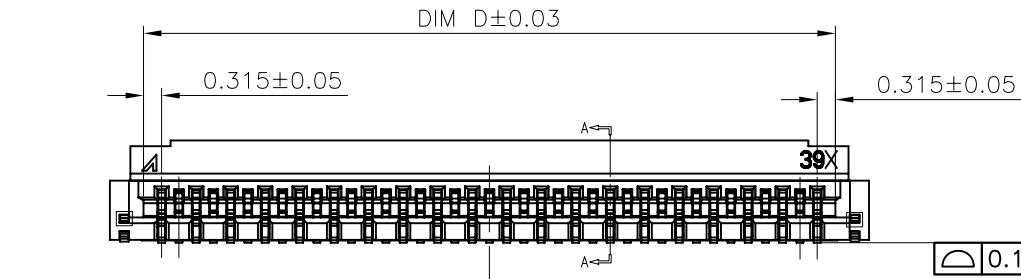

CODE	LOGO	PACKAGE
001	ACES	51515-XXXX-TRP
Q01	ACES	51515-XXXX-04-TRP
002	ACES	51515-XXXX-U-TRP(PLASTIC REEL)

51589-XXX X X -XXX  
 NO OF CKT  
 PACKING  
 0:TAPE & REEL  
 PLATING  
 M:3u" GOLD ON CONTACT AND  
 SOLDER FOR SELECTIVENESS PLATING

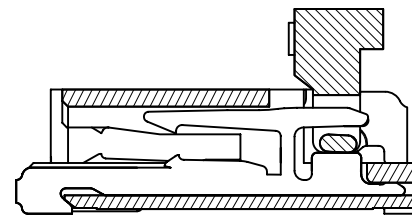
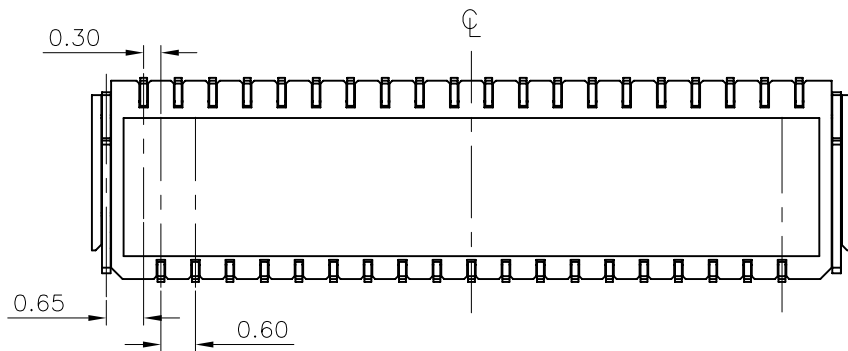
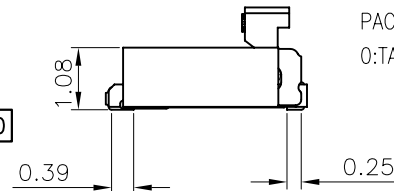

SECTION A-A

CKT	DIM A	DIM B	DIM C	DIM D	DIM E
9	4.20	2.40	1.80	3.03	3.00
11	4.80	3.00	2.40	3.63	3.60
13	5.40	3.60	3.00	4.23	4.20
15	6.00	4.20	3.60	4.83	4.80
17	6.60	4.80	4.20	5.43	5.40
19	7.20	5.40	4.80	6.03	6.00
21	7.80	6.00	5.40	6.63	6.60
23	8.40	6.60	6.00	7.23	7.20
25	9.00	7.20	6.60	7.83	7.80
27	9.60	7.80	7.20	8.43	8.40
31	10.80	9.00	8.40	9.63	9.60
33	11.40	9.60	9.00	10.23	10.20
35	12.00	10.20	9.60	10.83	10.80
39	13.20	11.40	10.80	12.03	12.00
41	13.80	12.00	11.40	12.63	12.60
45	15.00	13.20	12.60	13.83	13.80

QUALITY SYMBOLS MAJOR CRITICAL GENERAL TOLERANCES (UNLESS SPECIFIED) X. ±0.50 .X ±0.25 .XX ±0.15 .XXX ±0.10 ANGLES ±2°	DRAWN BY Lei, shanjun DATE 18/01/04	
	CHECKED BY Lu Jing Quan DATE 18/01/04	
	APPROVED BY hsieh fu yu DATE 18/01/04	SIZE <b>A4</b>
	UNITS <b>mm</b>	
	SCALE <b>2:1</b>	SHEET NO. <b>1 OF 4</b>
		DWG NO. <b>51589-XXXX-XXX</b>
		PART NO. <b>SEE NOTES</b>

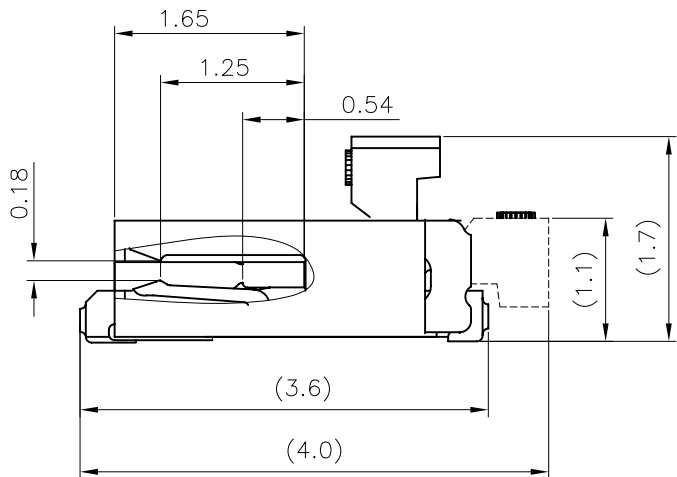

SCALE 2:1

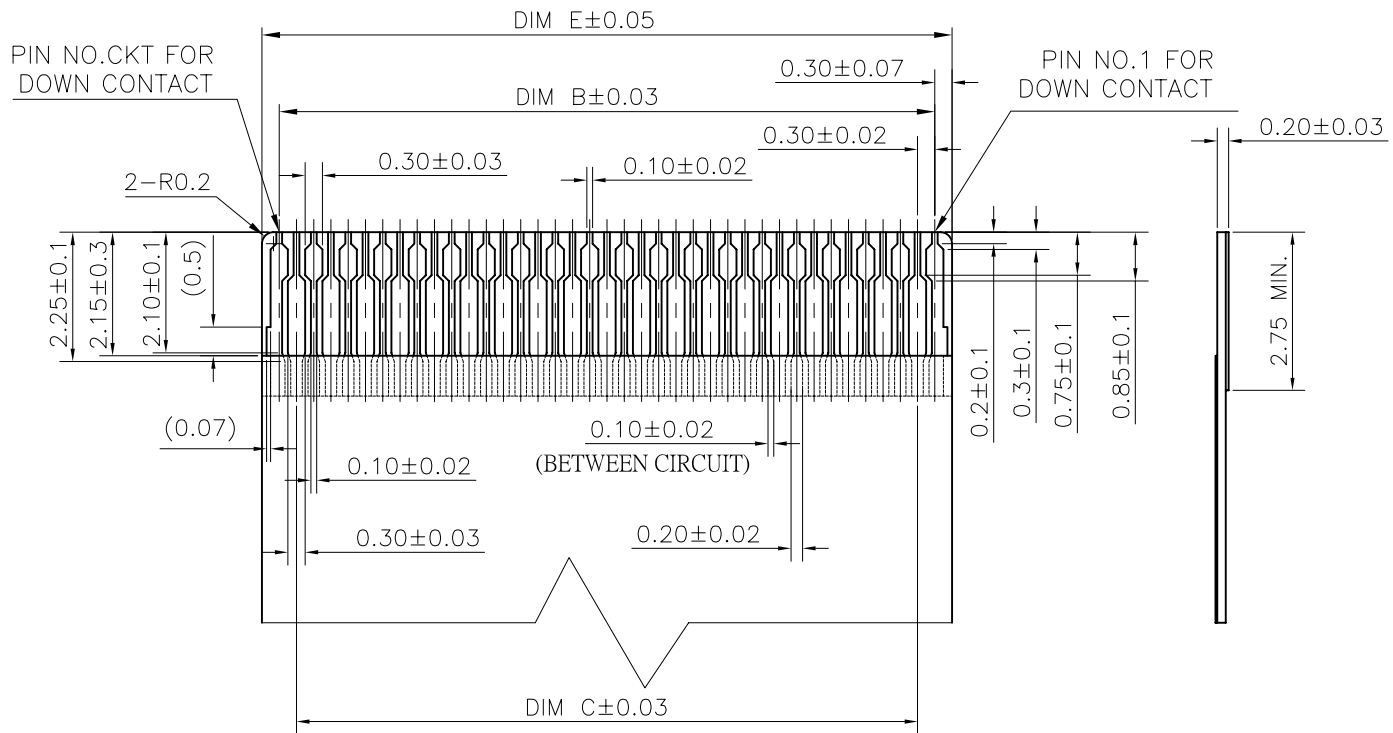

APPLICABLE FPC RECOMMENDED DIM  
(GENERAL TOLERANCE: ±0.05mm)

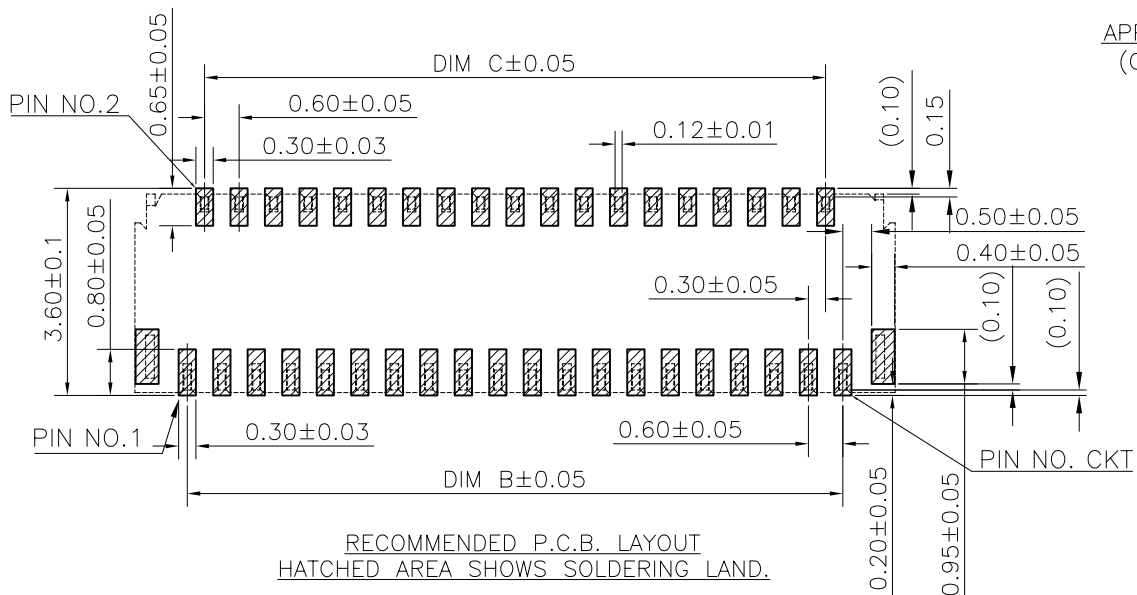

RECOMMENDED P.C.B. LAYOUT  
HATCHED AREA SHOWS SOLDERING LAND.

(GENERAL TOLERANCE: ±0.05mm)

<b>QUALITY SYMBOLS</b> MAJOR CRITICAL <b>GENERAL TOLERANCES (UNLESS SPECIFIED)</b> X. ±0.50 .X ±0.25 .XX ±0.15 .XXX ±0.10 ANGLES ±2°	DRAWN BY Lei, shanjun DATE 18/01/04	 <b>ACES ELECTRONICS</b> TITLE <b>0.3 MM PITCH ZIF BACK-FLIP FPC CONN SMT R/A D/C</b>
	CHECKED BY Lu Jing Quan DATE 18/01/04	
UNITS <b>mm</b>		SIZE <b>A4</b>
SCALE <b>2:1</b>	SHEET NO. <b>2 OF 4</b>	DWG NO. <b>51589-XXXX-XXX</b>
	REV <b>D</b>	PART NO. <b>SEE NOTES</b>

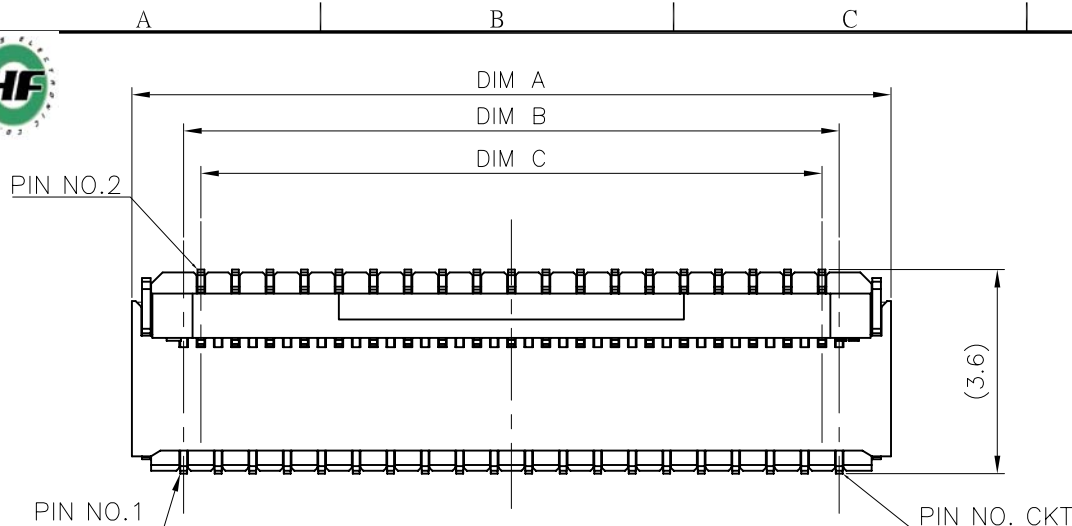

- NOTES:
- MATERIAL:
    - HOUSING: THERMOPLASTIC, HIGH TEMP.UL94V-0; COLOR:WHITE.
    - ACTUATOR: THERMOPLASTIC, HIGH TEMP.UL94 HB; COLOR:BLACK.
    - CONTACT: COPPER ALLOY
    - FITTING NAIL: COPPER ALLOY
  - FINISH:
    - CONTACT:
      - M: 50~120u" NICKEL PLATING OVERALL
      - 3u" MIN. GOLD PLATING ON CONTACT
      - 1u" MIN. PLATING GOLD FLASH ON SMT
    - FITTING NAIL:
      - 100~200u" MATT TIN PLATING ON SOLDER TAILS(LEAD FREE).
      - 50~100u" NICKEL UNDERPLATING OVERALL.
  - SPEC. PLS. REFER TO PS-51511-XXXXX-001
  - PACKAGE PLS. REFER TO 51515-XXXXX-06-TRP
  - PART NUMBER

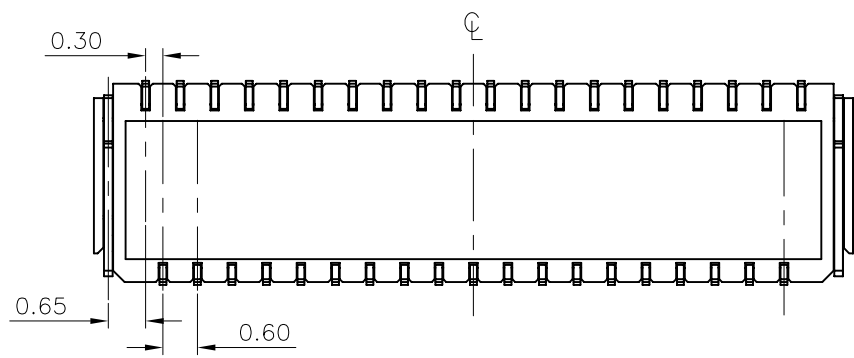
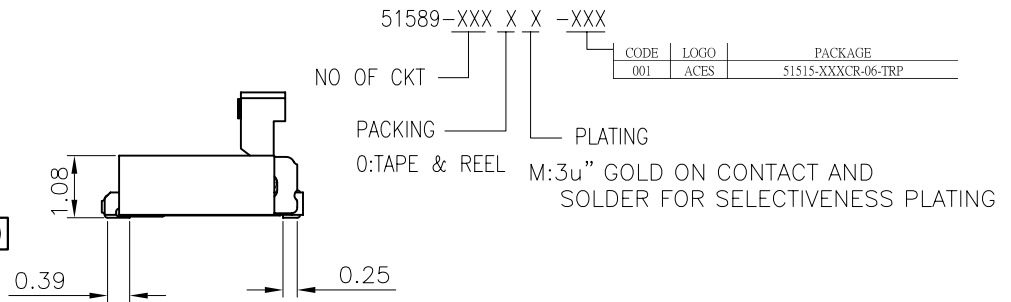
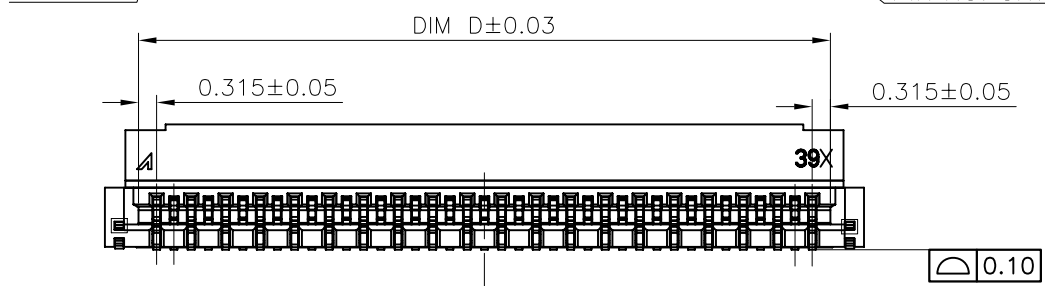

CKT	DIM A	DIM B	DIM C	DIM D	DIM E
51	16.80	15.00	14.40	15.63	15.60
61	19.80	18.00	17.40	18.63	18.60

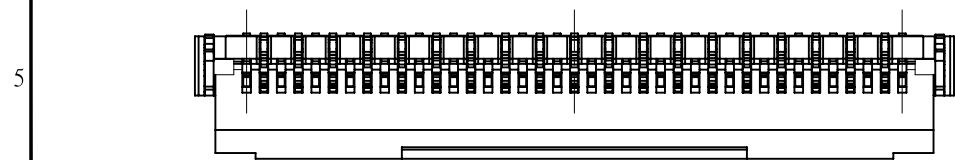

<b>QUALITY SYMBOLS</b> MAJOR Ⓜ CRITICAL Ⓢ <b>GENERAL TOLERANCES</b> (UNLESS SPECIFIED) X. ±0.50 .X ±0.25 .XX ±0.15 .XXX ±0.10 ANGLES ±2°	DRAWN BY Lei, shanjun DATE 18/01/04	
	CHECKED BY Lu Jing Quan DATE 18/01/04	
	APPROVED BY hsieh fu yu DATE 18/01/04	SIZE <b>A4</b>
UNITS <b>mm</b>		DWG NO. <b>51589-XXXXX-XXX</b>
SCALE <b>2:1</b>	SHEET NO. <b>3 OF 4</b>	REV <b>D</b>
		PART NO. <b>SEE NOTES</b>

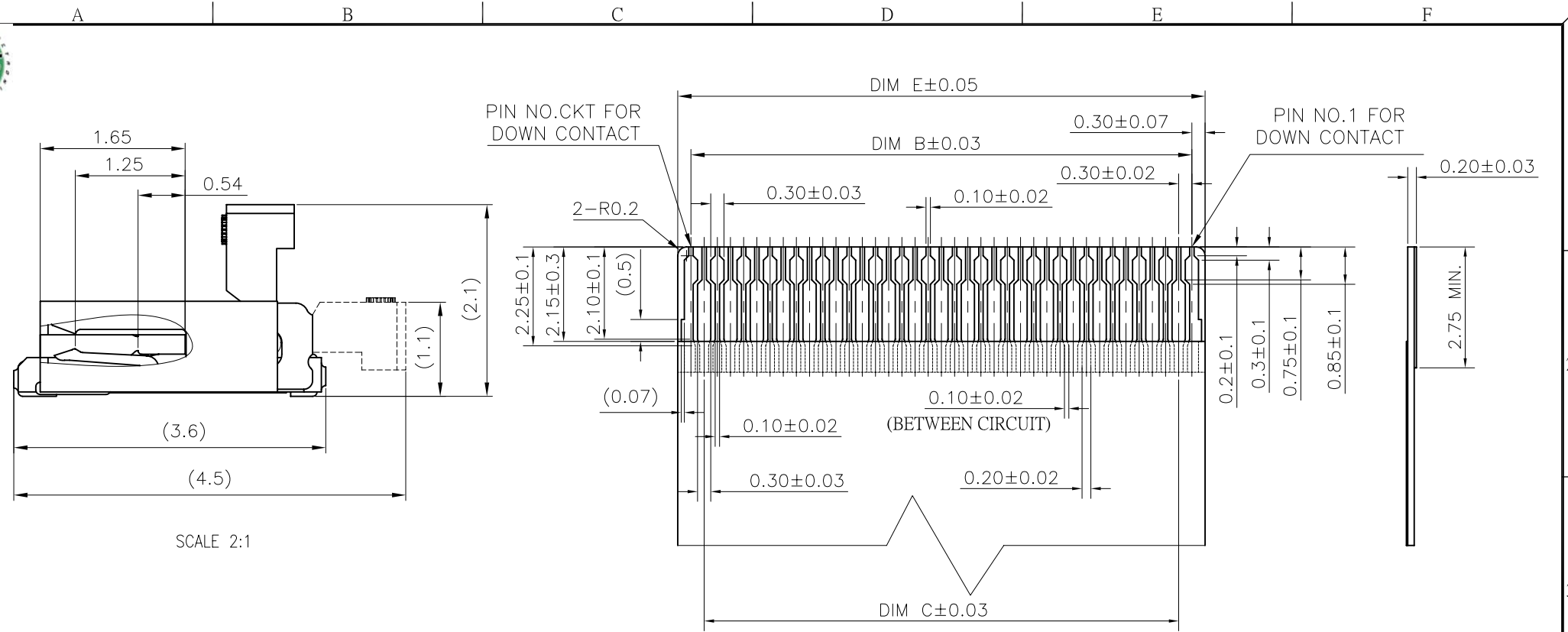

SCALE 2:1

APPLICABLE FPC RECOMMENDED DIM  
(GENERAL TOLERANCE: ±0.05mm)

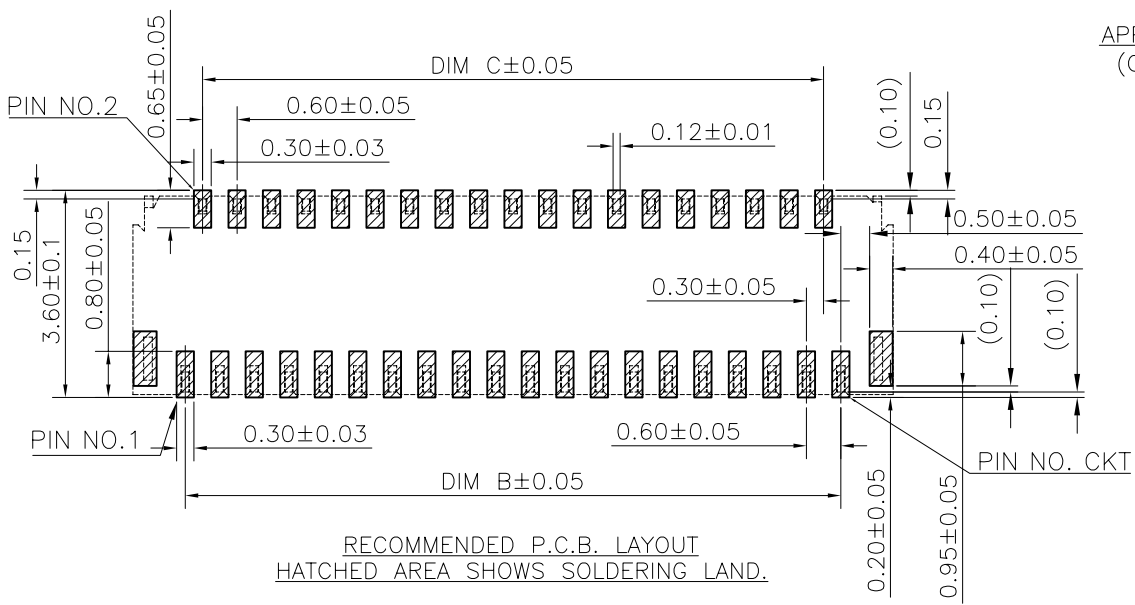

RECOMMENDED P.C.B. LAYOUT  
HATCHED AREA SHOWS SOLDERING LAND.  
(GENERAL TOLERANCE: ±0.05mm)

<b>QUALITY SYMBOLS</b> MAJOR CRITICAL <b>GENERAL TOLERANCES (UNLESS SPECIFIED)</b> X. ±0.50 .X ±0.25 .XX ±0.15 .XXX ±0.10 ANGLES ±2°	DRAWN BY Lei, shanjun DATE 18/01/04	 <b>0.3 MM PITCH ZIF BACK-FLIP FPC CONN SMT R/A D/C</b>
	CHECKED BY Lu Jing Quan DATE 18/01/04	
	APPROVED BY hsieh fu yu DATE 18/01/04	SIZE A4
UNITS mm		DWG NO. 51589-XXXXX-XXX
SCALE 2:1	SHEET NO. 4 OF 4	REV D
		PART NO. SEE NOTES

单击下面可查看定价，库存，交付和生命周期等信息

[>>ACES\(宏致\)](#)