

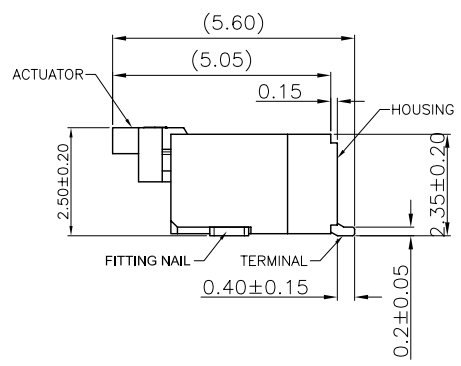

A B C D E F

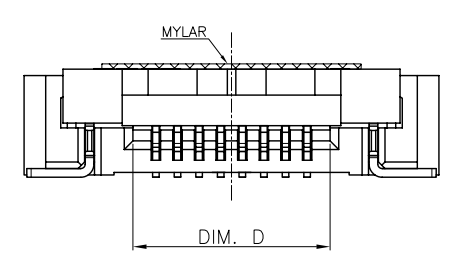
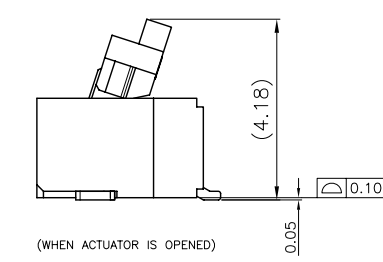
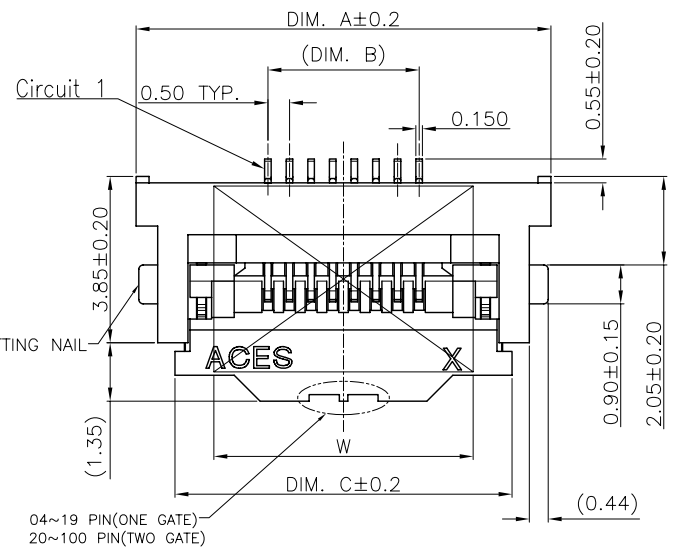
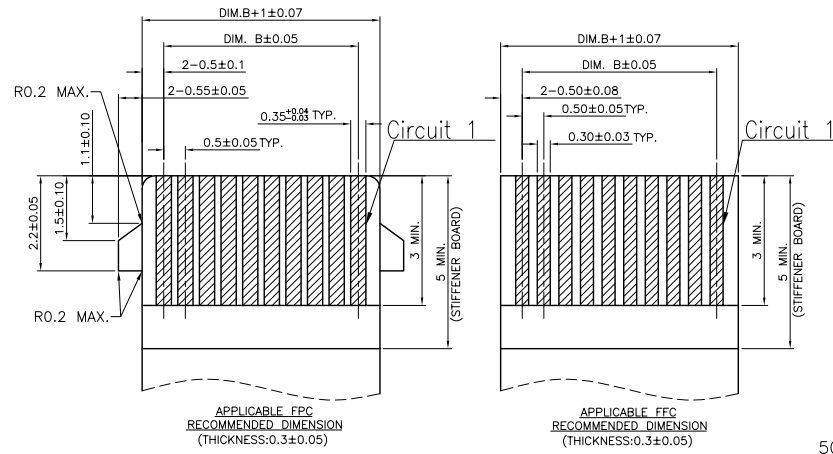
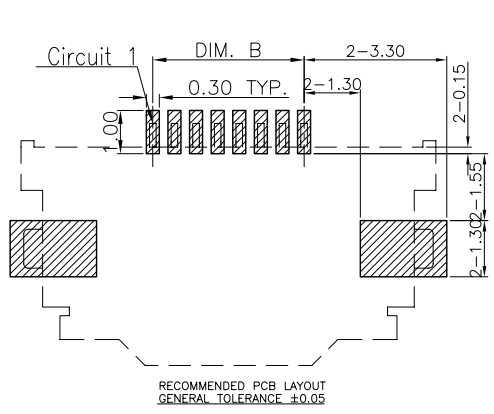

- NOTES:
- MATERIAL:
    - HOUSING: THERMOPLASTIC, HIGH TEMP.,UL94V-0;
    - ACTUATOR: THERMOPLASTIC, HIGH TEMP.,UL94V-0;
    - CONTACT: COPPER ALLOY;
    - FITTING NAIL:COPPER ALLOY.
  - FINISH:
    - CONTACT:
      - 50u" MIN. NICKEL PLATING OVERALL, N:100u" MIN. MATTE TIN PLATING OVERALL; 1:GOLD FLASH PLATING OVERALL; T:GOLD FLASH PLATING OVERALL,10u" GOLD PLATING ON CONTACT AREA.
    - FITTING NAIL:
      - 50u" MIN. NICKEL PLATING OVERALL, N:100u" MIN. MATTE TIN PLATING OVERALL; 1:GOLD FLASH PLATING OVERALL; T:100u" MIN. MATTE TIN PLATING OVERALL.
  - REFLOW SOLDER CAPABLE TO 260°C PER ACES SPEC.
  - SPEC. PLS. REFER TO PS-50520-XXXX-XXX. PACKING. PLS. REFER TO 91505-XXXX (-U)-TRP.
  - PART NUMBER

50520-XXX X X-XXX

NO OF CKT

XXX	Housing Color.	Actuator Color.	PACKAGE
001	BLACK	WHITE	91505-XXCR
002	WHITE	BLACK	91505-XXCR
003	BLACK	WHITE	91505-XXCR-04

PACKING  
0:TAPE & REEL  
1:TUBE  
4:TAPE & REEL WITH MYLAR  
5:TUBE WITH MYLAR

PLATING  
N: MATTE TIN  
1: GOLD FLASH OVERALL  
T: 10u" GOLD ON CONTACT

CKT	DIM A	DIM B	DIM C	DIM D	MYLAR W
005	8.10	2.00	6.30	3.08	6.00
006	8.60	2.50	6.80	3.58	6.00
008	9.60	3.50	7.80	4.58	6.00
010	10.60	4.50	8.80	5.58	6.00
012	11.60	5.50	9.80	6.58	6.00
013	12.10	6.00	10.30	7.08	6.00
015	13.10	7.00	11.30	8.08	6.00
020	15.60	9.50	13.80	10.58	12.00
040	25.60	19.50	23.80	20.58	16.00
050	30.60	24.50	28.80	25.58	16.00

一般公差 <b>TOLERANCES</b> X ±0.5 .XX ±0.15 X ±0.25 .XXX ±0.1 ANGLES ±2°		<b>宏致電子股份有限公司</b> <b>Aces Electronics Co.,Ltd.</b>	
檢驗尺寸標示 SYMBOLS Ⓢ INDICATE CLASSIFICATION DIMENSION Ⓢ MARK IS CRITICAL DIM. Ⓢ MARK IS MAJOR DIM.	品名 (TITLE) 0.5mm PITCH EASY ON FPC/FPC CONN.	製圖 (DR) WESLEY 17/03/20 審核 (CHKD) ANDREW 核准 (APPD) CHARLESLEE	圖號 (DWG NO.) 50520-XXXX-XXX
表面處理 (FINISH)	比例 (SCALE)	單位 (UNITS) mm	張數 (SHEET) 1 OF 2 尺寸 (SIZE) A4 版次 (REV) J

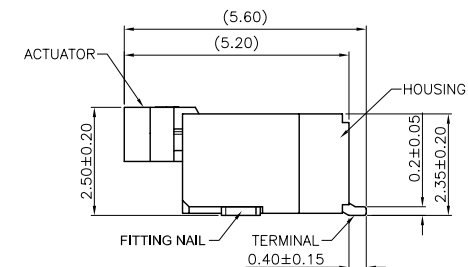
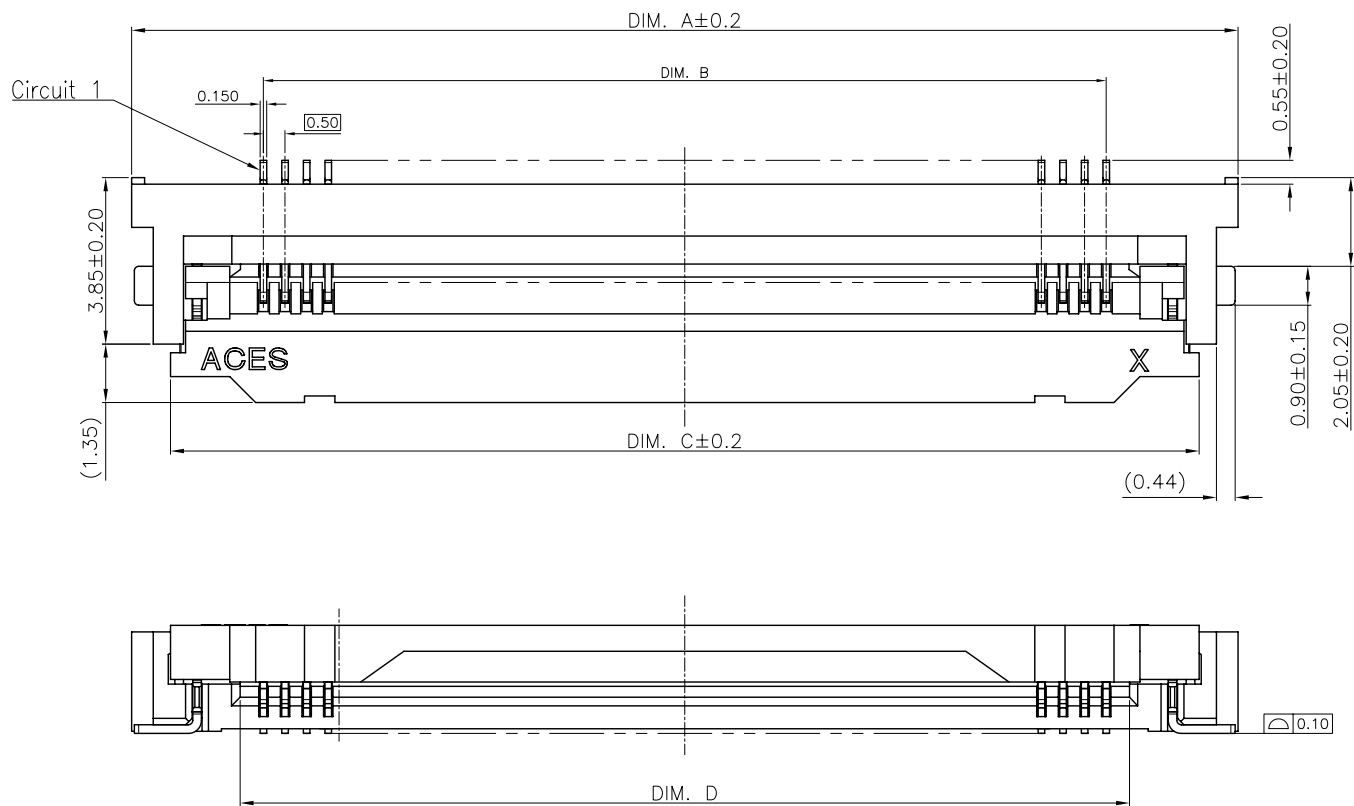

CKT	DIM A	DIM B	DIM C	DIM D	MYLAR W
060	35.60	29.50	33.80	30.58	16.00
064	37.60	31.50	35.80	32.58	16.00
068	39.60	33.50	37.80	34.58	16.00
080	45.60	39.50	43.80	40.58	20.00

一般公差 TOLERANCES X ±0.5 .XX ±0.15 X ±0.25 .XXX ±0.1 ANGLES ±2°		宏致電子股份有限公司 Aces Electronics Co.,Ltd.	
檢驗尺寸標示 SYMBOLS   INDICATE CLASSIFICATION DIMENSION MARK IS CRITICAL DIM. MARK IS MAJOR DIM.		品名 (TITLE) 0.5mm PITCH EASY ON FPC/FPC CONN. 圖號 (DWG NO.) 50520-XXXXX-XXX	
表面處理 (FINISH)		比例 (SCALE) 單位 (UNITS) mm	
17/03/20 核准 (CHKD) ANDREW 核淮 (APPD) CHARLESLEE		製圖 (DR) WESLEY 張數 (SHEET) 2 OF 2 尺寸 (SIZE) A4 版次 (REV) J	

单击下面可查看定价，库存，交付和生命周期等信息

[>>ACES\(宏致\)](#)