

# SPVQC Water-proof Type (Surface Mount)

Surface mount two-pole simultaneous changeover type achieving stable contact

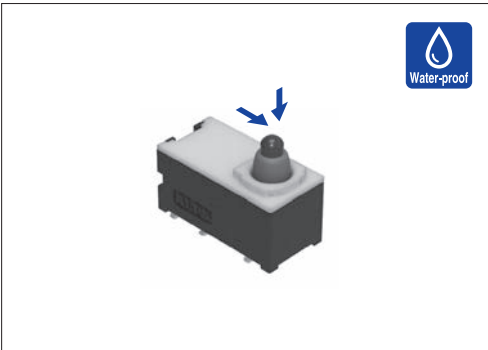

## Typical Specifications

Items		Specifications
Rating (max.)/(min.) (Resistive load)		50mA 18V DC / 50 $\mu$ A 5V DC
Contact resistance (Initial / After operating life)		75m $\Omega$ max. / 200m $\Omega$ max.
Operating force		1 $\pm$ 0.5N
Operating life	Without load	300,000cycles
	With load	300,000cycle (50mA 18V DC)

## Product Line

Poles	Positions	Changeover timing	Operating part shape	Terminal type	Minimum order unit (pcs)		Product No.
					Japan	Export	
2	2	Non shorting	Push	For PC board (Reflow)	300	2,400	<b>SPVQC10100</b>

## Note

This unit cannot be used in water (IP67 rating, except for terminal).

## Packing Specifications

Taping

Number of packages (pcs.)			Tape width (mm)	Export package measurements (mm)
1 reel	1 case /Japan	1 case /export packing		
300	1,200	2,400	32	403×403×360

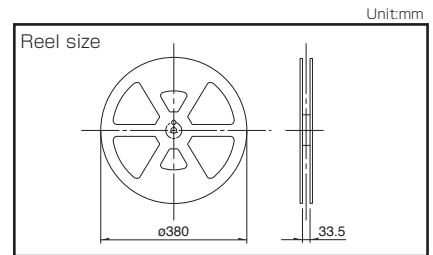

## Dimensions

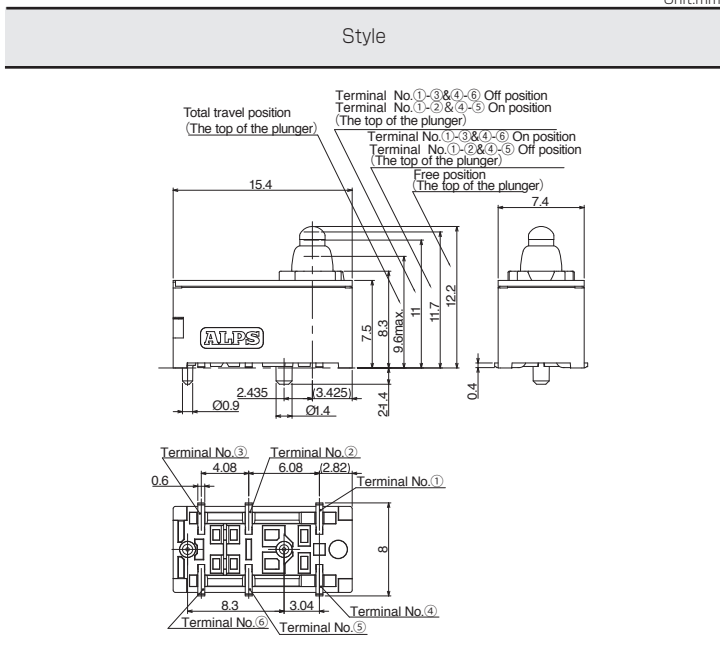



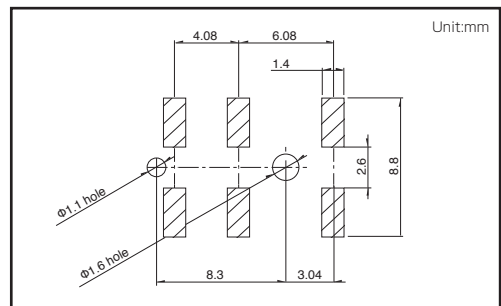



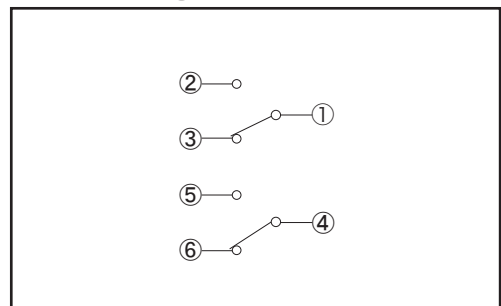



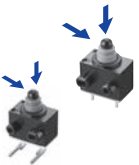

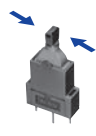
## PC Board Mounting Hole and Land Dimensions



## Circuit Diagram



Refer to P.73 for soldering conditions.

Series		Water-proof Type			Fast Switching Type		
		SPVQ8	SPVQ9	SSCN	SPVQ9	SPVQC	SPVQE
Photo							
Operation type		Two-way					
Dimensions (mm)	W	8.3	15.2	13	15.4	15.4	17.2
	D	5.3	6.4	5	8.4	7.4	12
	H	6.5	7.95	15	7.5	7.5	7.5
Operating temperature range		-40°C to +85°C					
Automotive use		●	●	●	●	●	●
Life cycle (availability)							
Poles / Positions		1/1	1/1 1/2	1/2	2/2	2/2	3/2
Rating (max.) (Resistive load)		0.1A 12V DC			50mA 26V DC	50mA 18V DC	
Rating (min.) (Resistive load)		50μA 5V DC		100μA 5V DC	50μA 5V DC		
Durability	Operating life without load	300,000cycles 1Ω max. or 1,000,000cycles 3Ω max.	300,000cycles 1Ω max.	100,000cycles 1Ω max.	300,000cycles 200mΩ max.		300,000 cycles CIRCUIT ①-②-③ and ④-⑤-⑥ 200mΩ max. CIRCUIT ⑦-⑧-⑨ 1Ω max.
	Operating life with load Rating (max.) (Resistive load)	300,000cycles 1Ω max. or 1,000,000cycles 3Ω max.	300,000cycles 1Ω max.	100,000cycles 1Ω max.	300,000cycles 200mΩ max.		300,000 cycles CIRCUIT ①-②-③ and ④-⑤-⑥ 200mΩ max. CIRCUIT ⑦-⑧-⑨ 1Ω max.
Electrical performance	Initial contact resistance	500mΩ max.			75mΩ max.		CIRCUIT ①-②-③ and ④-⑤-⑥ 75mΩ max. CIRCUIT ⑦-⑧-⑨ 250mΩ max.
	Insulation resistance	100MΩ min. 500V DC				100MΩ min. 250V DC	100MΩ min. 100V DC
	Voltage proof	500V AC for 1minute				250V AC for 1minute	100V AC for 1minute
Mechanical performance	Terminal strength	3N for 1minute (with terminal) Wire strength 30N for 1minute (with wire)		3N for 1minute			
	Actuator strength	20N		10N	20N		
Environmental performance	Cold	-40°C 500h					
	Dry heat	85°C 500h					
	Damp heat	60°C, 90 to 95% RH 500h					
Operation force		1±0.5N		2N max.	1±0.5N		
Page		61	66	69	70	71	72

Detector Switches Soldering Conditions	73
Detector Switches Cautions	74

#### Note

- Indicates applicability to all products in the series.

# Detector Switches Soldering Conditions

## Example of Reflow Soldering Condition

1. Heating method: Double heating method with infrared heater.
2. Temperature measurement: Thermocouple  $\phi 0.1$  to  $0.2$  CA (K) or CC (T) at soldering portion (copper foil surface). A heat resisting tape should be used for fixed measurement.
3. Temperature profile

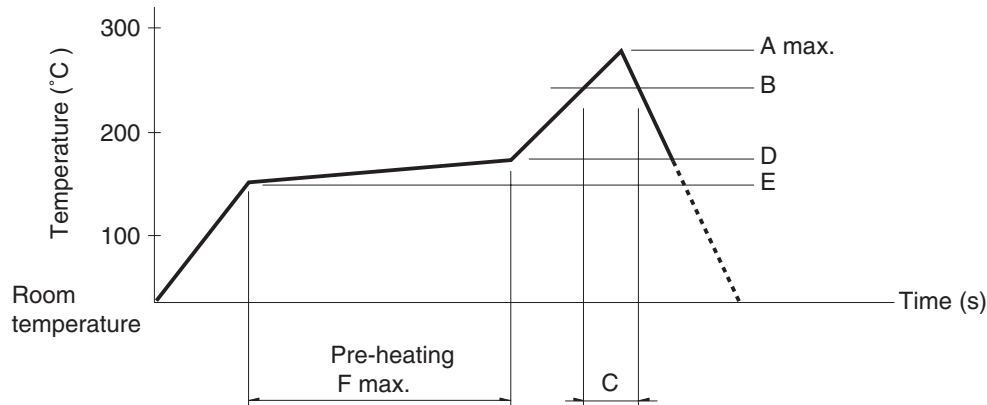

Series (Reflow type)	A (°C) 3s max.	B (°C)	C (s)	D (°C)	E (°C)	F (s)
<b>SPPB</b>	250		40			
<b>SPPW8</b>			35			
<b>SPVE</b>	260	230	40	180	150	120
<b>SPVL</b>						
<b>SPVM</b>						
<b>SPVN</b>						
<b>SPVR</b>						
<b>SPVS</b>						
<b>SPVT</b>						
<b>SSCM</b>						
<b>SSCQ</b>						
<b>SPVQC, SPVQE</b>	250					

### Notes

1. The condition mentioned above is the temperature on the mounting surface of a PC board. There are cases where the PC board's temperature greatly differs from that of the switch, surface depending on the PC board's material, size, thickness, etc. The above-stated conditions shall also apply to switch surface temperatures.
2. Soldering conditions differ depending on reflow soldering machines. Prior verification of soldering condition is highly recommended.

### Reference for Hand Soldering

Series	Soldering temperature	Soldering time
<b>SPVS, SPVN, SPVT, SPVM, SPVR, SPVE, SPPW8, SSCQ, SSCM, SPVL, SSCT, SPVQC, SPVQE</b>	350±5°C	3s max.
<b>SPVQ1, SPVQ3, SPVQ6, SPVQ7, SPVQ8, SPVQ9, SSCN, SPVQA</b>	300±10°C	3 + 1 / 0s
<b>SPPB (Reflow)</b>	300±5°C	5s max.
<b>SSCF, SPPB (For Lead, Dip)</b>	350±10°C	3 + 1 / 0s

### Reference for Dip Soldering

(For PC board terminal types)

Series	Items		Dip soldering	
	Preheating temperature	Preheating time	Soldering temperature	Duration of immersion
<b>SSCT, SPVQ1, SPVQ3, SPVQ6, SPVQ7, SPVQ8, SPVQ9, SPVQA</b>	100±10°C	60s max.	260±5°C	5±1s
<b>SPPW8, SPPB</b>	100 °C max.	60s max.	255±5°C	5±1s
<b>SSCF</b>	—		260±5°C	5±1s

Detector

Slide

Push

Rotary

Power

Dual-In-line Package Type

General-purpose Type

Water-proof Type

Fast Switching Type

单击下面可查看定价，库存，交付和生命周期等信息

[>>ALPS Electric\(阿尔卑斯\)](#)