

Meets automotive needs with a sealed contact structure for dust resistance



TACT Switch™

Sharp Feeling™

Soft Feeling™

Snap-In Type

Surface Mount Type

Radial Type

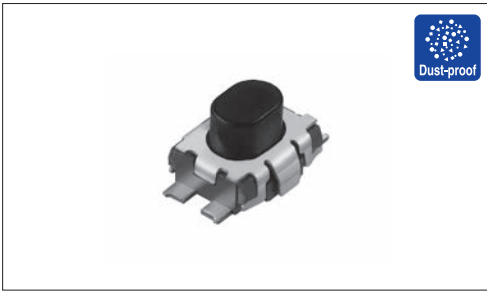

### Typical Specifications

Items	Specifications
Rating (max.)	25mA 16V DC
Rating (min.)	10μA 1V DC
Initial contact resistance	500mΩ max.
Travel (mm)	0.12

### Product Line

Product No.	Operating force	Operating direction	Operating life (5mA 5V DC)	Stem height	Minimum order unit (pcs.)		Drawing No.
					Japan	Export	
<b>SKTHBAE010</b>	3N	Top push	200,000 cycles	2.5mm	4,000	4,000	1
<b>SKTHACE010</b>	1.4N		100,000 cycles	1.8mm	5,000	5,000	2
<b>SKTHAEE010</b>	5N		200,000 cycles	1.75mm			3

### Packing Specifications

Taping

Series	Number of packages (pcs.)			Tape width (mm)	Export package measurements (mm)
	1 reel	1 case / Japan	1 case / export packing		
<b>SKTHBA</b>	4,000	40,000	40,000	12	395×395×205
<b>SKTHAC SKTHAE</b>	5,000	50,000	50,000		

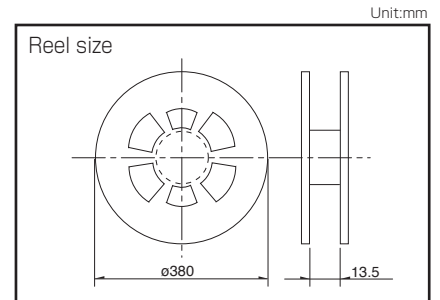

### Note

For reels of 330mm diameter, please inquire.

### Dimensions

No.	Style	PC board mounting hole and land dimensions (Viewed from switch mounting face)
1		

Refer to P.265 for soldering conditions.

■ Dimensions

Unit:mm

No.	Style	PC board mounting hole and land dimensions (Viewed from switch mounting face)
2		
3		

■ Circuit Diagram

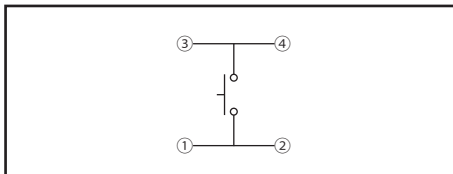

TACT Switch™

Sharp Feeling

Soft Feeling

Snap-in Type

Surface Mount Type

Radial Type

# TACT Switch™

## List of Varieties

TACT Switch™



















Sharp Feeling

Soft Feeling

Snap-In Type

Surface Mount Type

Radial Type

Type		Sharp Feeling Type									
		Surface Mount									
Series		SKRK	SKTH	SKRP	SKQM	SKQY	SKSU	SKST	SKRA	SKHM	
Photo											
Features		Compact size Low-profile	Compact size	High operation force Compact size	Compact size		Middle travel			—	
Water-proof		—	—	—	—	—	●	—	○	—	
Dust-proof		—	●	—	—	—	●	—	○	—	
IP standard		—	—	—	—	—	67 equivalency	—	67 equivalency	—	
Operating direction	Top push	●	●	●	●	●	●	●	●	●	
	Side push	—	—	—	—	—	—	—	—	—	
Dimensions (mm)	W	3.9	3.5	4.2	6	6.1	5.3	8.5	□6.2	6.2	
	D	2.9	3.2	3.2	3.5	3.7	5.4			6.5	
	H	1.5/2	1.8/2.5	2.5	4.3/5	2.5	3.85	3.95	3.5/5.2	3.1	
Operation force coverage	1N max.	↕	↕	↕	↕	↕			↕	↕	
	1N to 2N		↕	↕	↕	↕			↕	↕	
	2N to 3N			↕	↕	↕	↕	↕	↕	↕	
	3N to 4N						↕	↕	↕	↕	
	4N to 5N						↕	↕	↕	↕	
Travel (mm)		0.13	0.12	0.2	0.25		0.7	0.9	See the relevant pages for respective product descriptions		
Ground terminal		—	—	—	—	○	—	—	—	●	
Operating temperature range		-40°C to +85°C			-40°C to +90°C					-40°C to +85°C	
Automotive use		—	●	●	●	●	●	●	○	—	
Life Cycle											
Electrical performance	Rating (max.) (Resistive load)	50mA 12V DC	25mA 16V DC	50mA 16V DC	50mA 12V DC		50mA 16V DC		50mA 12V DC		
	Rating (min.) (Resistive load)	10μA 1V DC									
	Insulation resistance	100MΩ min. 100V DC 1min.									
	Voltage proof	250V AC 1min.	100V AC 1min.	250V AC 1min.							
Durability	Vibration	10 to 55 to 10Hz/min., the amplitude is 1.5mm for all the frequencies, in the 3 direction of X, Y and Z for 2 hours respectively									
	Lifetime	Shall be in accordance with individual specifications.									
Environmental performance	Cold	-40°C 96h		-40°C 1,000h	-40°C 96h		-40°C 1,000h		-40°C 96h		
	Dry heat	90°C 96h		90°C 1,000h	90°C 96h		90°C 1,000h		90°C 96h		
	Damp heat	60°C, 90 to 95%RH 96h		60°C, 90 to 95%RH 1,000h	60°C, 90 to 95%RH 96h		60°C, 90 to 95%RH 1,000h		60°C, 90 to 95%RH 96h		
Page		230	232	234	235	236	238	239	240	241	

W : Width. The most outer dimension excluding terminal portion.  
D : Depth. The most outer dimension excluding terminal portion.  
H : Height. The minimum dimension if there are variances.

TACT Switch™ Soldering Conditions . . . . . 265  
TACT Switch™ Cautions . . . . . 266

### Notes

- The automotive operating temperature range to be individually discussed upon request.
- Indicates applicability to all products in the series, while ○ indicates applicability to some products in the series.

## Condition for Reflow

Available for Surface Mount Type.

1. Temperature measurement: Thermocouple  $\phi$  0.1 to 0.2 CA (K) or CC (T) at solder joints (copper foil surface).  
A heat resistive tape should be used to fix thermocouple.
2. Temperature profile

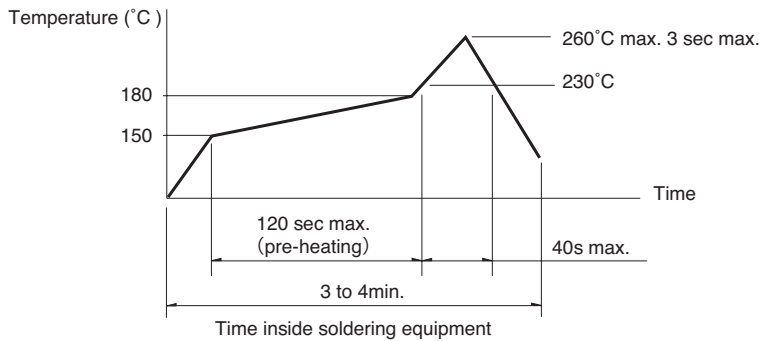

### Notes

1. The above temperature shall be measured of the top of switch. There are cases where the PC board's temperature greatly differs from that of the switch, depending on the material, size, thickness of PC boards and others.  
The above-stated conditions shall also apply to switch surface temperatures.
2. Soldering conditions differ depending on reflow soldering machines.  
Prior verification of soldering condition is highly recommended.

## Conditions for Auto-dip

Available for Snap-in Type and Radial Type.

Items	Condition
Flux built-up	Mounting surface should not be exposed to flux
Preheating temperature	Ambient temperature of the soldered surface of PC board. 100°C max.
Preheating time	60s max.
Soldering temperature	260°C max.
Duration of immersion	5s max.
Number of soldering	2times max.

### SKHH, SKPD Series

Items	Condition
Flux built-up	Mounting surface should not be exposed to flux
Preheating temperature	Ambient temperature of the soldered surface of PC board. 110°C max.
Preheating time	60s max.
Soldering temperature	260°C max.
Duration of immersion	5s max.
Number of soldering	2times max.

### SKQJ, SKQK, SKEG Series

Items	Condition
Flux built-up	Mounting surface should not be exposed to flux
Preheating temperature	Ambient temperature of the soldered surface of PC board. 100°C max.
Preheating time	45s max.
Soldering temperature	255°C max.
Duration of immersion	5s max.
Number of soldering	2times max.

## Manual Soldering

Items	Condition
Soldering temperature	350°C max.
Duration of soldering	3s max.
Capacity of soldering iron	60W max.

### SKHH, SKHW, SKRG, SKPD Series

Items	Condition
Soldering temperature	360°C max.
Duration of soldering	3s max.
Capacity of soldering iron	60W max.

### SKTD, SKTG, SKQJ, SKQK, SKEG Series

Items	Condition
Soldering temperature	350°C max.
Duration of soldering	3s max.
Capacity of soldering iron	20W max.

### Notes

1. Prevent flux penetration from the top side of the TACT Switch™.
2. Switch terminals and a PC board should not be coated with flux prior to soldering.
3. The second soldering should be done after the switch is stable with normal temperature.
4. Use the flux with a specific gravity of min 0.81.  
(EC-19S-8 by TAMURA Corporation, or equivalents.)

单击下面可查看定价，库存，交付和生命周期等信息

[>>ALPS Electric\(阿尔卑斯\)](#)