

REVISIONS					
REV	ECO	DESCRIPTION	DATE	BY	APPR
A3	-	RELEASE NEW DWG FORMAT	18/JUN/13	DRP	-

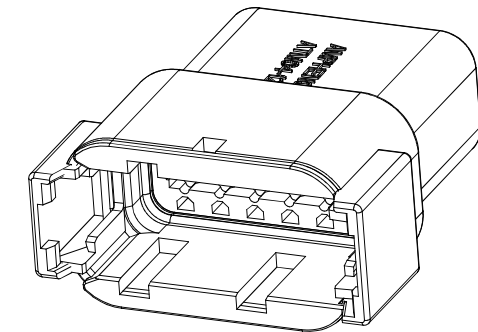

REQUIRES CONTACT RETENTION WEDGE AWM-8P

1 KEYWAY (3) PLACES

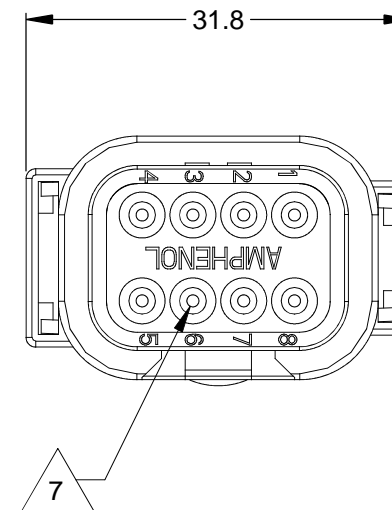
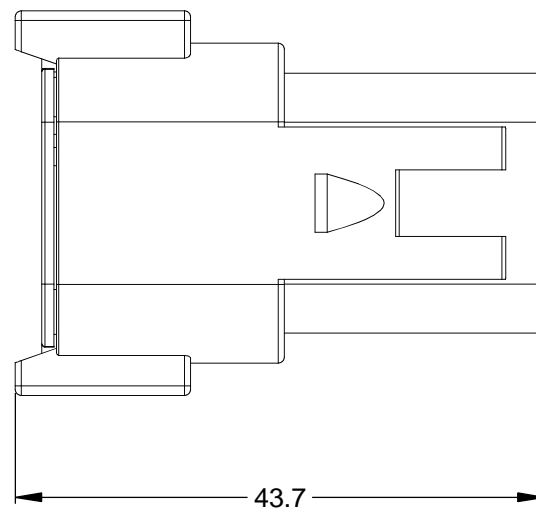
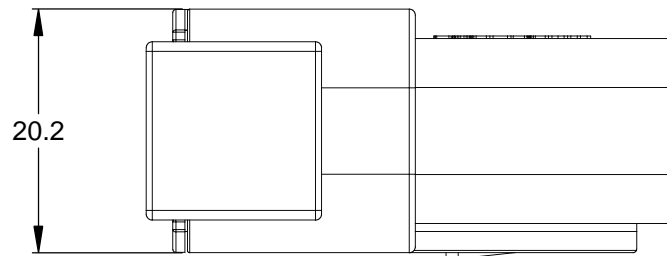
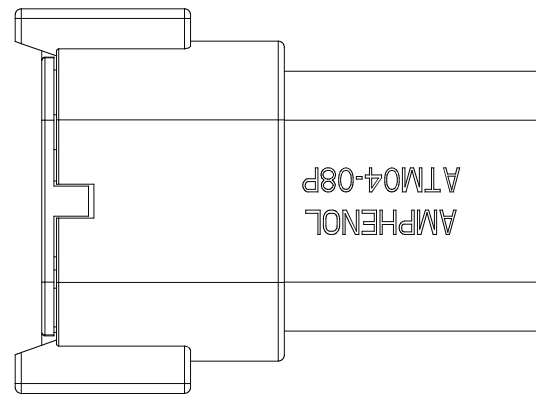
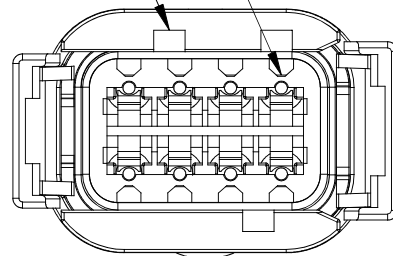

NOTES: UNLESS OTHERWISE SPECIFIED

1 SEE SHEET 2 FOR KEY ARRANGEMENTS AND COLORS.

2. MATERIAL:
HOUSING: THERMOPLASTIC
SEAL: SILICONE RUBBER

3. MODIFICATIONS: N/A

4. SPECIFICATIONS:
4.1 CURRENT RATING: 7.5 AMPS
4.2 OPERATING TEMPERATURE: -55°C TO +125°C.
4.3 DIELECTRIC WITHSTANDING VOLTAGE: LESS THAN 2 MILLIAMPS CURRENT LEAKAGE @ 1500 VOLTS AC.
4.4 INSULATION RESISTANCE: 1000 MEGOHMS MIN @ 25°C.
4.5 MOISTURE RESISTANCE: IP67 (MATED CONDITION)
4.6 MATING CYCLE DURABILITY: 100 CYCLES
4.7 RoHS COMPLIANT

5. MATING PART: ATM06-08SX* PLUG.
(X = A,B,C,D KEYS; * = MODIFICATIONS AND COLORS)

6. ALL DIMENSIONS ARE FOR REFERENCE USE ONLY.

7 CONTACT SIZE AND REAR SEAL WIRE RANGE:

CONTACT SIZE	MIN. INSUL O.D.	MAX. INSUL O.D.	TYPICAL WIRE RANGE
20	1.35 mm (.053 in)	3.05 mm (.120 in)	16 - 22 AWG

QUANTITY	SEE SHEET 2 PART NUMBER	DESCRIPTION	ITEM
MATERIALS LIST			
UNLESS OTHERWISE SPECIFIED 1) All dimensions are in metric (mm). 2) Tolerances are as follows: 1 PL DEC ±0.30 2 PL DEC ±0.15 3 PL DEC ±0.08 Fractions ±1/64 Angles ±1° 3) Note reference = X		SIGNATURES DRAWN: D.PARKS CHECKED: ENGINEER: APPROVAL:	DATE 18/JUN/13
MATERIAL SPECIFICATIONS:		Amphenol Sine Systems - www.amphenol-sine.com 44724 Morley Drive Clinton Township, MI 48036	
PROCESS SPECIFICATIONS:		RECEPTACLE, KEYED, 8 PIN, ATM SERIES	
NEXT ASSY:	CUSTOMER: THIS DRAWING IS SUPPLIED FOR INFORMATION ONLY. DESIGN FEATURES, SPECIFICATIONS AND PERFORMANCE DATA SHOWN HEREON ARE THE PROPERTY OF THE AMPHENOL CORPORATION. NO RIGHTS OF REPRODUCTION ARE IMPLIED. ALL DIMENSIONS ARE SUBJECT TO NORMAL MANUFACTURING VARIATIONS.	SCALE: NONE	REVISION A3
		SHEET 1 OF 2	

TITLE: RECEPTACLE, KEYED, 8 PIN, ATM SERIES
DWG NO.: ATM04-08PX-XXX
REV: A3
SH: 1
OF: 2

REVISIONS					
REV	ECO	DESCRIPTION	DATE	BY	APPR

P/N ATM04-08PA
KEY-A CONFIGURATION
STANDARD COLOR: GREY

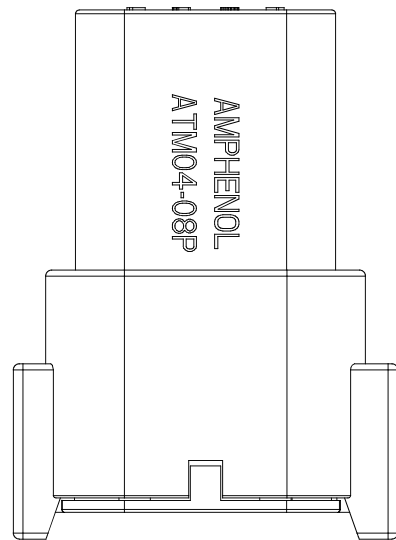

P/N ATM04-08PB
KEY-B CONFIGURATION
STANDARD COLOR: BLACK

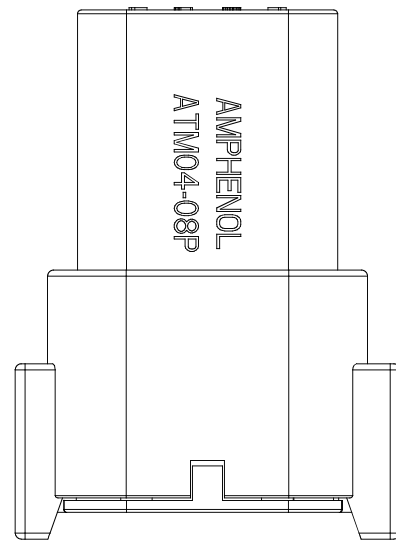

P/N ATM04-08PC
KEY-C CONFIGURATION
STANDARD COLOR: GREEN

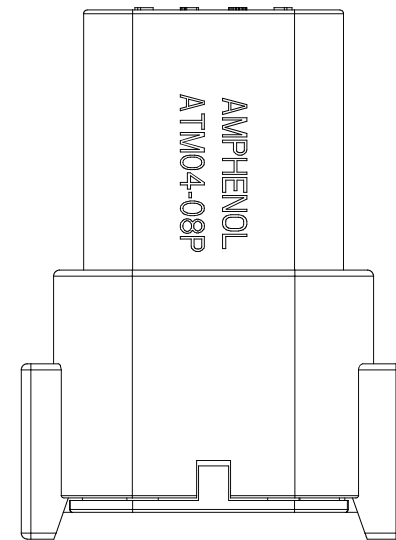

P/N ATM04-08PD
KEY-D CONFIGURATION
STANDARD COLOR: BROWN

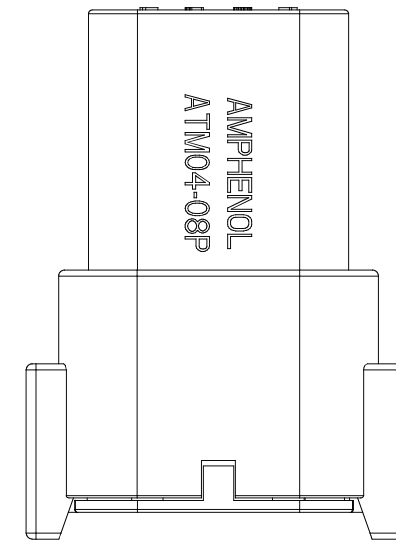

KEYWAY (3) PLACES

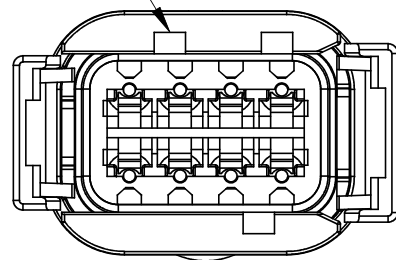

KEYWAY (3) PLACES

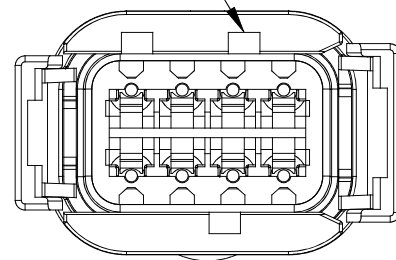

KEYWAY (3) PLACES

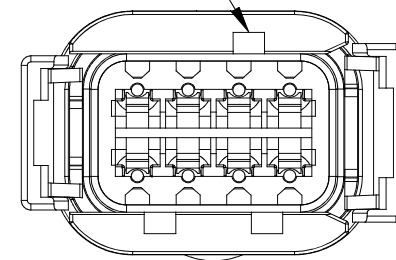

KEYWAY (3) PLACES

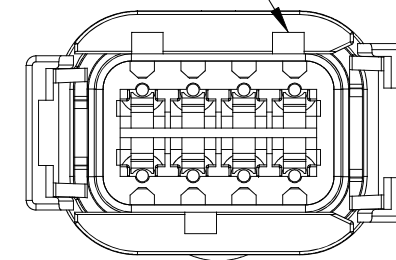

KEY-A CONFIGURATION	
COLOR	PART NUMBER
* GREY	ATM04-08PA
BLACK	ATM04-08PA-BLK
GREEN	ATM04-08PA-GRN
BROWN	ATM04-08PA-BRN

KEY-B CONFIGURATION	
COLOR	PART NUMBER
GREY	ATM04-08PB-GRY
* BLACK	ATM04-08PB
GREEN	ATM04-08PB-GRN
BROWN	ATM04-08PB-BRN

KEY-C CONFIGURATION	
COLOR	PART NUMBER
GREY	ATM04-08PC-GRY
BLACK	ATM04-08PC-BLK
* GREEN	ATM04-08PC
BROWN	ATM04-08PC-BRN

KEY-D CONFIGURATION	
COLOR	PART NUMBER
GREY	ATM04-08PD-GRY
BLACK	ATM04-08PD-BLK
GREEN	ATM04-08PD-GRN
* BROWN	ATM04-08PD

NOTE:

AN ASTERISKS (*) PLACED BEFORE THE COLOR DENOTES THE STANDARD MOLDED COLOR OF THE CONNECTORS SHOWN ABOVE.

OTHER COLORS SHOWN ARE AVAILABLE VIA SPECIAL ORDER.

TITLE: RECEPTACLE, KEYED, 8 PIN, ATM SERIES
DWG NO.: ATM04-08PX-XXX
REV: A3
SH: 2
OF: 2

QUANTITY	PART NUMBER	DESCRIPTION	ITEM
MATERIALS LIST			
UNLESS OTHERWISE SPECIFIED 1) All dimensions are in metric (mm). 2) Tolerances are as follows: 1 PL DEC ±0.30 2 PL DEC ±0.15 3 PL DEC ±0.08 3) Note reference =		SIGNATURES DATE DRAWN: D.PARKS 18/JUN/13 CHECKED: ENGINEER: APPROVAL:	
MATERIAL SPECIFICATIONS:		CUSTOMER:	
PROCESS SPECIFICATIONS:		THIS DRAWING IS SUPPLIED FOR INFORMATION ONLY. DESIGN FEATURES, SPECIFICATIONS AND PERFORMANCE DATA SHOWN HEREON ARE THE PROPERTY OF THE AMPHENOL CORPORATION. NO RIGHTS OF REPRODUCTION ARE IMPLIED. ALL DIMENSIONS ARE SUBJECT TO NORMAL MANUFACTURING VARIATIONS.	
NEXT ASSY:		SCALE: NONE	
		Amphenol Sine Systems - www.amphenol-sine.com 44724 Morley Drive Clinton Township, MI 48036	
		RECEPTACLE, KEYED, 8 PIN, ATM SERIES	
SIZE	TYPE	DWG NO.	REVISION
B	C-	ATM04-08PX-XXX	A3
SHEET 2 OF 2			

单击下面可查看定价，库存，交付和生命周期等信息

[>>Amphenol\(安费诺\)](#)