

REV.	ECN NO.	DATE	SIGN	DESCRIPTION

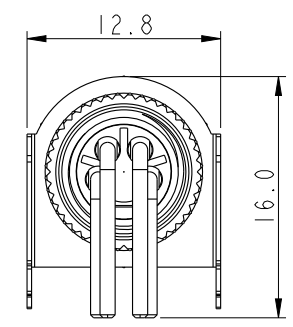

ALTW
CONFIDENTIAL
2016-01-20
R&D DEPT.

ALTW
DCC. DEPT.
CONFIDENTIAL
2016.01.27
ISSUED

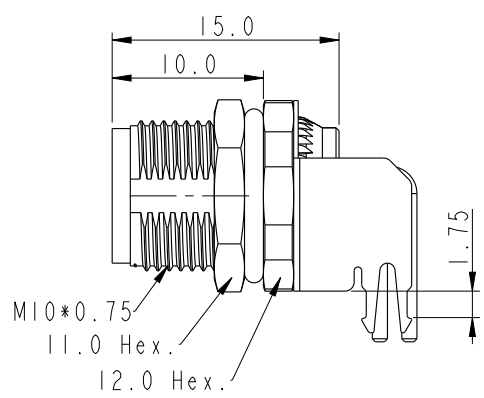
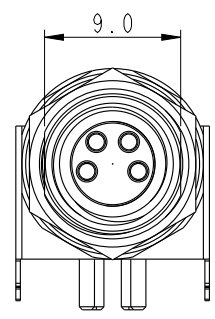
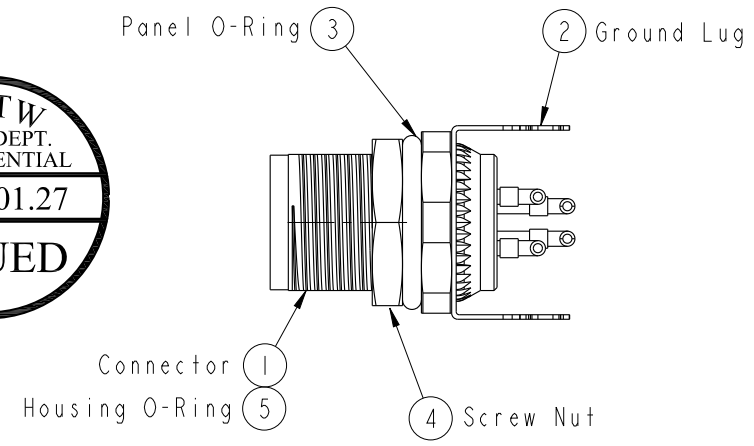

- Note:
- * \varnothing Important Dimension.
 - * Waterproof Rate: IP68.
IP68: 1M Depth of Water in 24hours.
 - * Housing: Nylon+GF, Black.
 - * Female Pin: Copper Alloy, Gold Plated.
 - * Shell: Metal, Nickel Plated.
 - * Ground Lug: Copper Alloy, Nickel Plated.
 - * Screw Nut: Copper Alloy, Nickel Plated.
 - * Panel O-Ring: Viton, Green.
 - * Housing O-Ring: Viton, Green.
 - * Rated Voltage: 3Pin 60V dc. or ac.
4Pin 30V dc. or ac.
 - * Rated Current: 3 & 4Pin 4A
 - * Operating Temperature: -40~105°C
 - * For Panel Thickness: Min=2.0mm, Max=4.5mm.
 - * For PCB Thickness: Max=1.6mm.
 - * Recommended Nut Torque: 4~6 Kgf.cm.

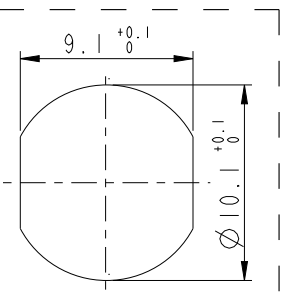

Recommended
Panel Cut-Out

UNIT: mm		
TOLERANCE	±0.25	
.X	±0.1	
.XX	±0.05	
.XXX	±0.05	
ANGLES	±1°	

TITLE M8 Female Conn. Panel 90° PCB Type (Shielded)		
SCALE 2:1	SIZE A4	SHEET 1 OF 2
REV. A	WC-REV. A.11	\varnothing : Inspection item

Amphenol LTW
安費諾亮泰企業股份有限公司

ITEM NO.	DRAWN BY Yulong_wang	DATE 2016-01-20
DWG NO. M8S-XXPFFR-SF8001	CHECKED BY Cary	DATE 2016-01-20
CUSTOMER ALTW	APPROVED BY Jerry	DATE 2016-01-20

THIS DOCUMENT IS SUBJECT TO CHANGE WITHOUT NOTICE. IT IS CONFIDENTIAL AND A PROPERTY OF AMPHENOL LTW. DISCLOSURE TO THIRD PARTY HAS TO BE AUTHORIZED BY AMPHENOL LTW.

THIS DOCUMENT IS SUBJECT TO CHANGE WITHOUT NOTICE. IT IS CONFIDENTIAL AND A PROPERTY OF Amphenol LTW. DISCLOSURE TO THIRD PARTY HAS TO BE AUTHORIZED BY Amphenol LTW.

M 8S - XX P F F R - S F 8 001

8: M8 Sensor Shielded
 03: 3Pin
 04: 4Pin
 P: Panel (板端)
 F: Female Connector (母座)
 F: Female Pin (母Pin)

001: Phantom (虚拟料号)
 8: IP68 (防水等级68)
 F: Front Fasten (前锁式/Enclosure Rear Mount)
 S: Screw (螺紋式)
 R: 90° PCB THT/DIP Type (90° 基板插件式)

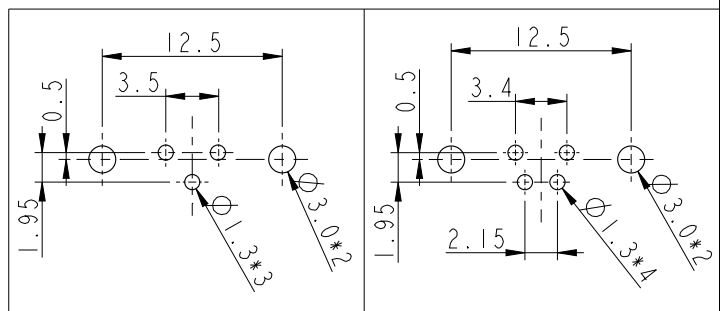
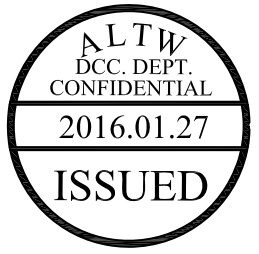
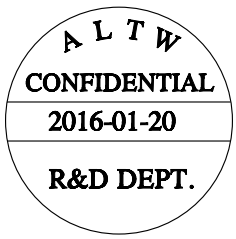

Recommend PCB Layout

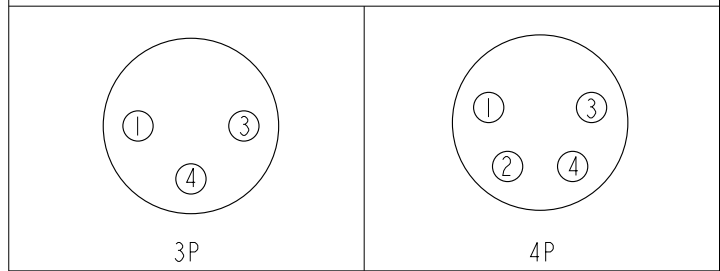

Pin Assignmen Front View

UNIT: mm		
TOLERANCE	.X ±0.25	
.XX ±0.1		
.XXX ±0.05		
ANGLES	±1°	

TITLE M8 Female Conn. Panel 90° PCB Type (Shielded)		
SCALE 2:1	SIZE A4	SHEET 2 OF 2
REV. A	WC-REV. A.11	☉: Inspection item

Amphenol LTW
 安費諾亮泰企業股份有限公司

ITEM NO	DRAWN BY Yulong_wang	DATE 2016-01-20
DWG NO M8S-XXPFFR-SF8001	CHECKED BY Cary	DATE 2016-01-20
CUSTOMER ALTW	APPROVED BY Jerry	DATE 2016-01-20

单击下面可查看定价，库存，交付和生命周期等信息

[>>Amphenol\(安费诺\)](#)