

10132797- AA B C D E F LF

AA	POSITION
01	2X05
02	2X10
03	2X15
04	2X20
05	2X25
06	2X30
08	2X40

B	DESCRIPTION
1	PLUG 1
2	PLUG 2
3	PLUG 3
4	PLUG 4
5	PLUG 5
6	PLUG 6
7	PLUG 7

D	POLARIZATION PEG	HOLD DOWN
0	YES	YES
1	NO	YES
2	YES	NO
3	NO	NO

E	PACKAGING
0	TAPE AND REEL WITHOUT CAP

F	CUSTOMER CODE
BLANK	STANDARD P/N
V	APPLY FOR SPECIAL CUSTOMER

*NOTE 6

C	PLATING: CONTACT AREA/SOLDER TAIL AREA
1	1~3u" Au ON CONTACT AREA OVER 50u" Ni Min GOLD FLASH ON SOLDER TAIL OVER 50u" Ni Min

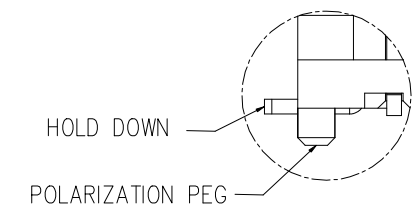

10132797 SERIES (PLUG SERIES)					
COMBINATION OF MATED HEIGHT 3.0~4.5mm	Plug 1	Plug 2	Plug 3	Plug 4	
Recep 1					
COMBINATION OF MATED HEIGHT 5.0~6.0mm	Plug 5	Plug 6	Plug 7	/	
	Recep 2				

NOTE:

- MATERIAL:
HOUSING: THERMOPLASTIC BLACK UL94V-0
TERMINAL: COPPER ALLOY
HOLD DOWN: COPPER ALLOY
- PLATING:
TERMINAL: 1~3u" Au ON CONTACT AREA OVER 50u" Ni Min
GOLD FLASH ON SOLDER TAIL OVER 50u" Ni Min
HOLD DOWN: 100u" Tin Min ON SOLDER TAIL OVER 50u" Ni Min
- SEE GS-12-1298 FOR PRODUCT SPEC.
- PACKAGING: TAPE AND REEL WITHOUT CAP.
- THIS PRODUCT MEETS THE EUROPEAN UNION DIRECTIVES AND OTHER COUNTRY REGULATIONS AS DESCRIBED IN GS-22-008.
- 80 PIN IS OPTIONAL FOR ONLY PLUG 1.

NOTE:
THE CONNECTORS ARE SYMMETRICAL, THE DISPLAYED ORIENTATIONS ARE FOR REFERENCE ONLY.

mat'l. code		surface ISO 1302 ✓	tolerance ISO 406 ISO 1101	projection	product family Bergstak
ltr	ecn no	dr	date	tolerances unless otherwise specified	title
E	ELX-N-36246-1	BY	2022/11/29	angles	BERGSTAK 0.5mm PITCH BTB PLUG
F	ELX-N-46614-1	BY	2022/11/29	linear	
				0±.2'	mm
				.00±.15	scale 1:1
				.000±.10	dwg no
		dr	Y-Y Bao	2022/11/29	sheet 1 of 3
		engr	Y-Y Bao	2022/11/29	size
		chr	Li-Qing Lei	2022/11/29	10132797
		appd	Tim Yao	2022/11/29	type
					Product Customer Drawing
sheet index	revision	F			
	sheet	1/3			

Amphenol FCI
 © 2016 AFCI
 D

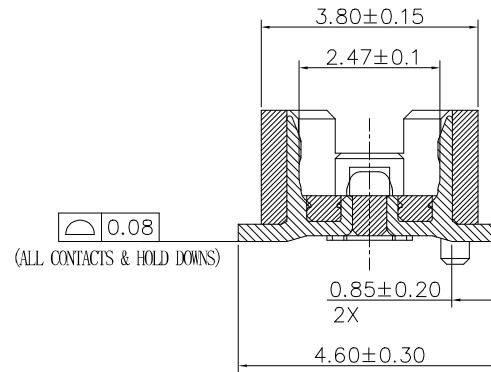
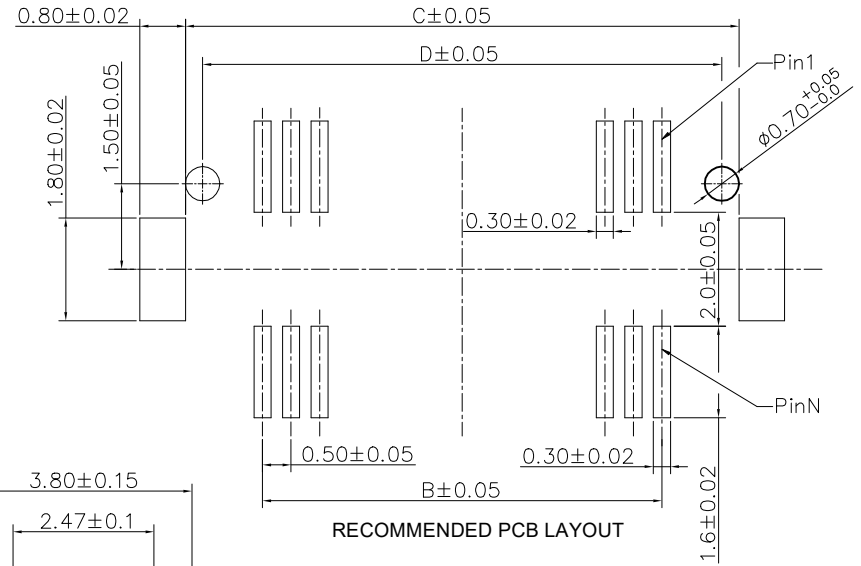
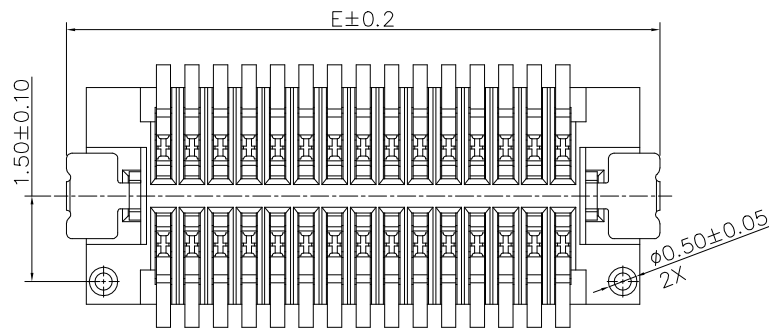
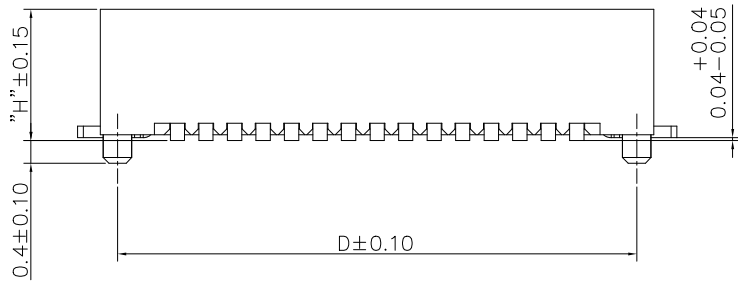
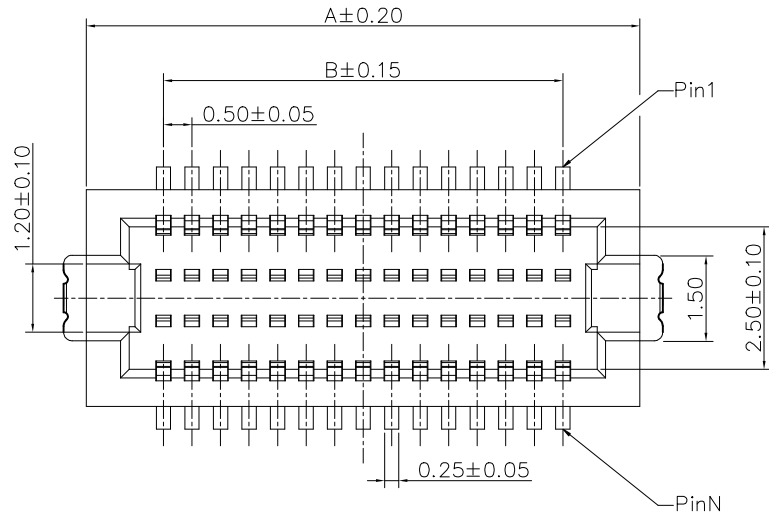

TYPE	"H"
PLUG 1	2.30
PLUG 2	2.80
PLUG 3	3.30
PLUG 4	3.80

pin.No.	A	B	C	D	E
10	4.70	2.00	4.70	4.10	5.50
20	7.20	4.50	7.20	6.60	8.00
30	9.70	7.00	9.70	9.10	10.50
40	12.20	9.50	12.20	11.60	13.00
50	14.70	12.00	14.70	14.10	15.50
60	17.20	14.50	17.20	16.60	18.00
80	22.20	19.50	22.20	21.60	23.00

PLUG 1~4

mat'l. code		surface ISO 1302 ✓	tolerance ISO 406 ISO 1101	projection	product family Bergstak
ltr	ecn no	dr	date	tolerances unless otherwise specified	title
F				angles linear .0±.2 0°±2' .00±.15 .000±.10	BERGSTAK 0.5mm PITCH BTB PLUG
		dr	Y-Y Bao	2022/11/29	Amphenol FCI
		engr	Y-Y Bao	2022/11/29	dwg no 10132797
		chr	Li-Qing Lei	2022/11/29	sheet 2 of 3
		appd	Tim Yao	2022/11/29	size A3
sheet index	revision	F			type Product Customer Drawing
	sheet	2/3			

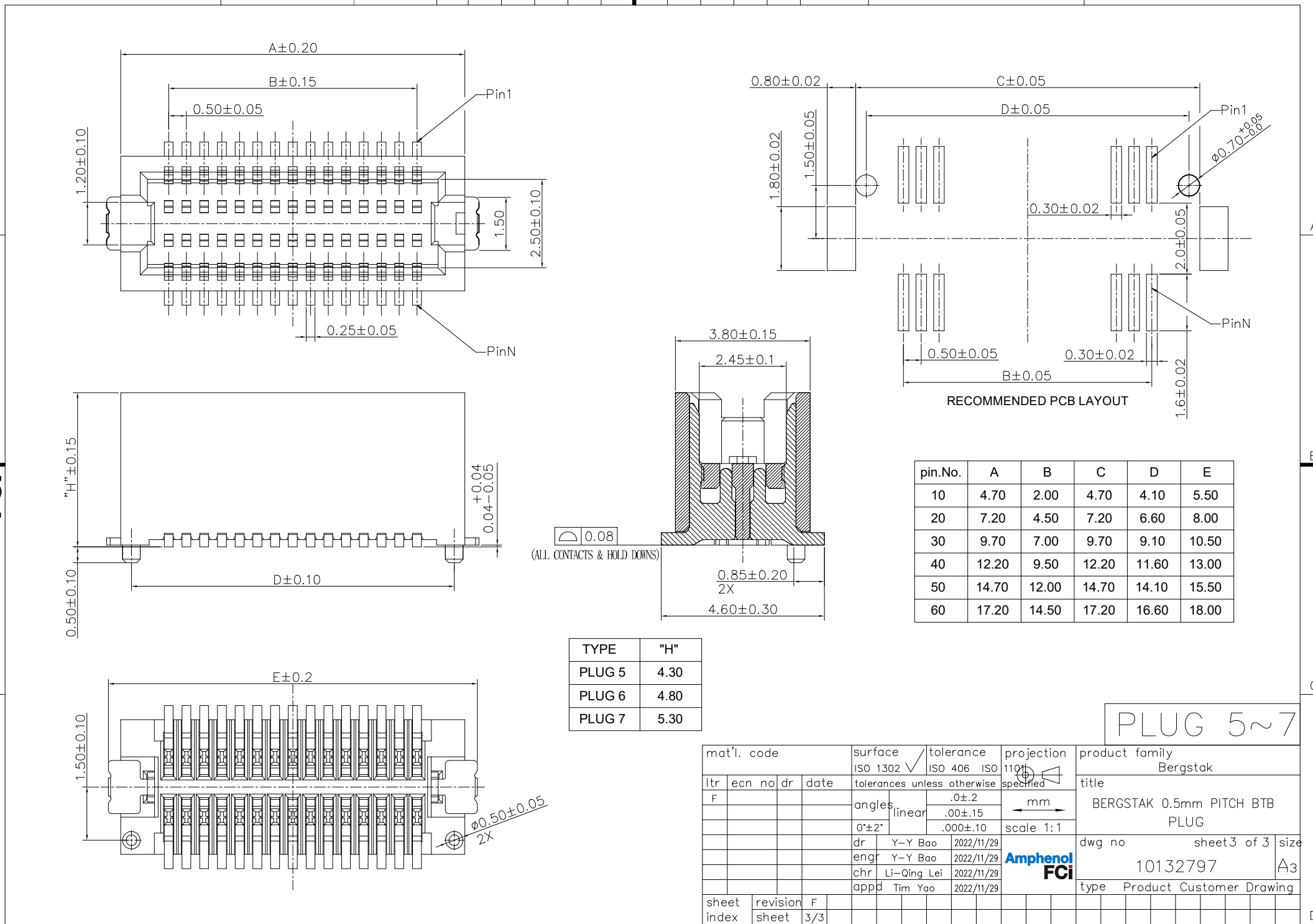

mat'l. code		surface ISO 1302 ✓		tolerance ISO 406 ISO 1101		projection 1101		product family Bergstak	
ltr		ecn no		dr		date		title	
F								BERGSTAK 0.5mm PITCH BTB PLUG	
								dwg no 10132797	
								sheet 3 of 3	
								size A3	
								type Product Customer Drawing	
sheet index		revision sheet		F 3/3					



单击下面可查看定价，库存，交付和生命周期等信息

[>>Amphenol\(安费诺\)](#)