

(VIEW WITH CAP)

NOTES:

- MATERIAL:
HSG: OPTIONAL, UL94V-0.
COLOR: NATURAL.
TERMINAL: BRASS.
PLATING: 50u" NI UNDERPLATING; OPTIONAL ON CONTACT AREA.
PICK & PLACE CAP: HIGH TEMP. THERMOPLASTIC WIRE CONNECTOR 10127815.
- THIS PLUG MATES WITH FCI RECEPTACLE WIRE CONNECTOR 10127815.
- PRODUCT SPECIFICATION: GS-12-1181.
- PACKAGE SPECIFICATION: GS-14-2362.
- THE HOUSING WILL WITHSTAND EXPOSURE TO 235°C PEAK TEMPERATURE FOR 5 SECONDS IN A WAVE SOLDER APPLICATION WITH A 1.6mm MINIMUM THICK CIRCUIT BOARD. (FOR PA66)
THE HOUSING WILL WITHSTAND EXPOSURE TO 260 °C PEAK TEMPERATURE FOR 10 SECONDS IN A REFLOW OVEN. (FOR LCP ONLY)

6. PART NUMBER SCHEME:
10127820- XX X X X X X LF

POS. CODE:
02: 2 POS.
04: 4 POS.
24: 24 POS.

BLANK: NO CAP, TRAY PACKAGE
C: WITH CAP, TAPE/REEL PACKAGE
T: NO CAP, TAPE/REEL PACKAGE

TERMINAL MATERIAL:
2: BRASS, TAIL LENGTH 3.5mm
3: BRASS, TAIL LENGTH 1.9mm

PEG:
BLANK: NO PEG
P: 2 PEGS

PLATING CODE:
1: GOLD FLASH
2: 80u" Min Tin
4: 30u" Au
S: GOLD FLASH ON CONTACT, MATTE TIN ON TAILS

GLOW WIRE COMPATIBLE:
BLANK: PA66, NON COMPATIBLE
C: PA66, COMPATIBLE
L: LCP, COMPATIBLE
B: LCP, BLACK COMPATIBLE

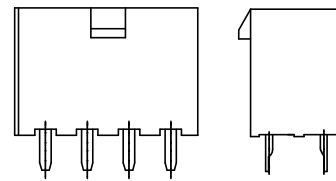
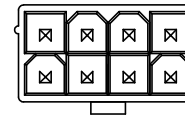
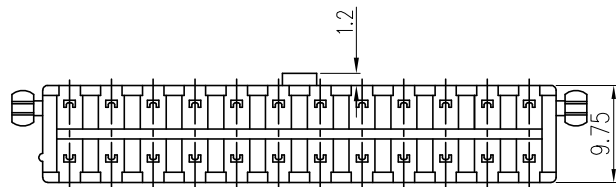
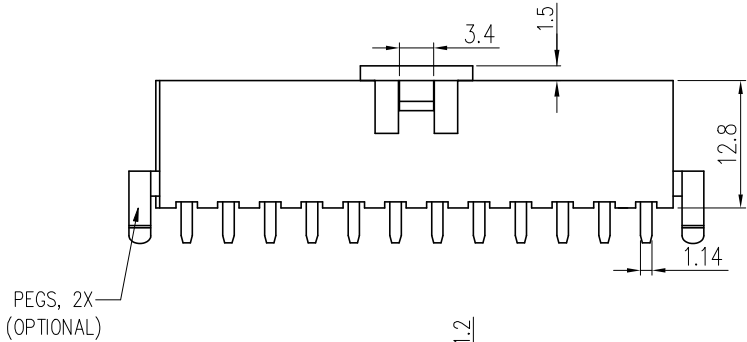
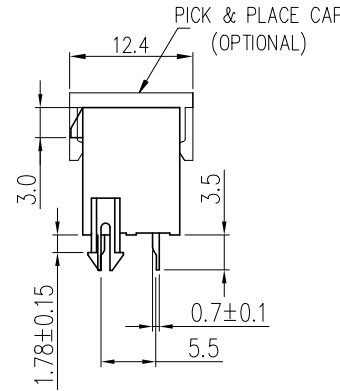

PART WITHOUT PEGS

7. DIMENSIONAL & PART NO. TABLE:

PART NUMBER	POS.	A	B
10127820-02XXXXXL	02	4.2	5.4
10127820-04XXXXXL	04	4.2	9.6
10127820-06XXXXXL	06	8.4	13.8
10127820-08XXXXXL	08	12.6	18.0
10127820-10XXXXXL	10	16.8	22.2
10127820-12XXXXXL	12	21.0	26.4
10127820-14XXXXXL	14	25.2	30.6
10127820-16XXXXXL	16	29.4	34.8
10127820-18XXXXXL	18	33.6	39.0
10127820-20XXXXXL	20	37.8	43.2
10127820-22XXXXXL	22	42.0	47.4
10127820-24XXXXXL	24	46.2	51.6

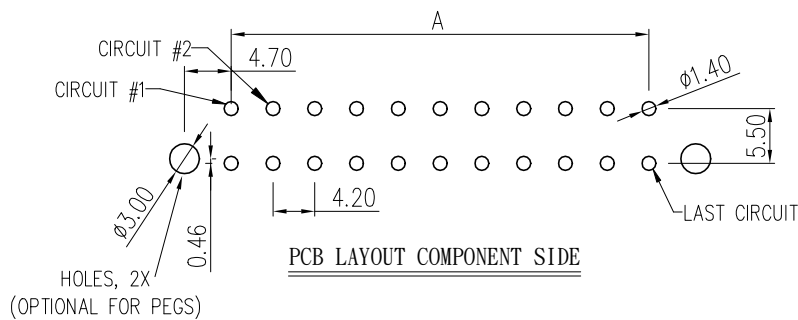

PCB LAYOUT COMPONENT SIDE

mat'l. code		surface ISO 1302 ✓		tolerance ISO 406 ISO		projection 1101		product family MINITEK PWR4.2	
ltr	ecn no	dr	date	tolerances unless otherwise specified		mm		title	
H	ELX-T-17184	TAI	2015-03-16	angles	.0±.40	mm		MINITEK PWR4.2,WTB HEADER, DUAL ROW,VT,DIP TYPE	
J	ELX-T-21113	TAI	2015-06-08	linear	.00±.30	mm			
K	ELX-T-21843	TAI	2016-06-02	0°±1'		scale 1:1			
L	ELX-T-26123	TAI	2017-02-20	dr	KENNY TAI	2013-11-11		dwg no sheet 1 of 2 size	
M	ELX-N-26497	TONY	2017-03-23	eng	KENNY TAI	2013-11-11		10127820 A3	
N	ELX-N-28165	TONY	2017-10-16	chr	KENNY TAI	2013-11-11			
P	ELX-N-30477	TONY	2018-06-15	app	PM ZHENG	2013-11-22		type Product Customer Drawing	
sheet	revision	P	P						
index	sheet	1	2						

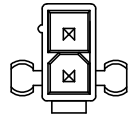

2 POS

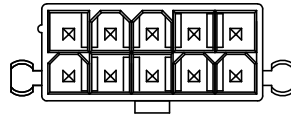

10 POS

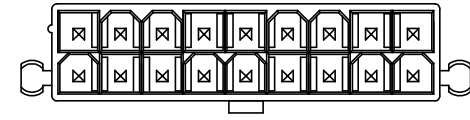

18 POS

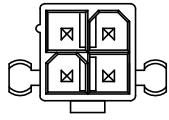

4 POS

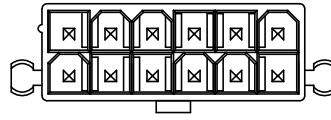

12 POS

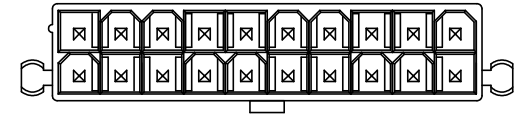

20 POS

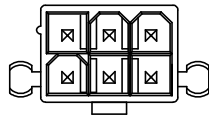

6 POS

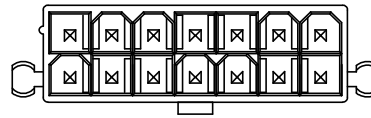

14 POS

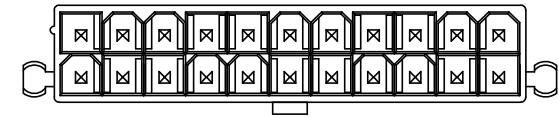

22 POS

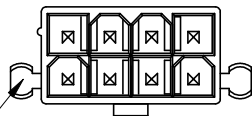

8 POS

WITH PEG

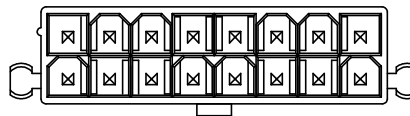

16 POS

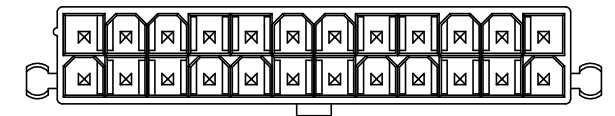

24 POS

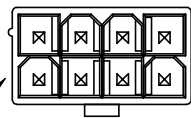

VIEW WITHOUT PEG

NO PEG

mat'l. code		surface	tolerance	projection	product family
ISO 1302		ISO 406	ISO	1101	MINITEK PWR4.2
tolerances unless otherwise specified		.0±.40		mm	title
linear		.00±.30			
angles		0°±1'		scale 1:1	MINITEK PWR4.2,WTB HEADER, DUAL ROW,VT,DIP TYPE
dr	KENNY TAI	2013-11-11	Amphenol FCI		dwg no
eng	KENNY TAI	2013-11-11	sheet 2 of 2		size
chr	KENNY TAI	2013-11-11	10127820		A3
app	PM ZHENG	2013-11-22	type		Product Customer Drawing
sheet index	revision sheet	P 1	P 2		

单击下面可查看定价，库存，交付和生命周期等信息

[>>Amphenol\(安费诺\)](#)