

This document is the property of Amphenol Corporation and is delivered on the express condition that it is not to be disclosed, reproduced or used, in whole or in part, for manufacture or sale by anyone other than Amphenol Corporation without its prior consent, & that no right is granted to disclose or to use any information in this document.

CUSTOMER DRAWING

REVISIONS				
SYM	ECN	DESCRIPTION	DATE	APPROVED
1	HK7304	RELEASE TO CUSTOMER	01/18'16	IP
2	TBA	UPDATE THE TITLE OF DRAWING	02/22'17	IP
3	TBA	ADD MISSED DIMENSION AND SOLDER AREA	05/18'17	IP
4	HK8547	ADD NEW PACKING OPTION	03/11'19	IP

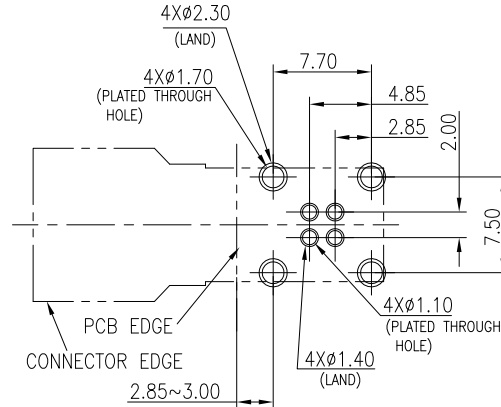
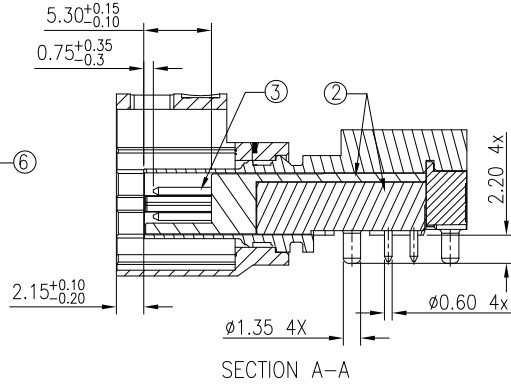
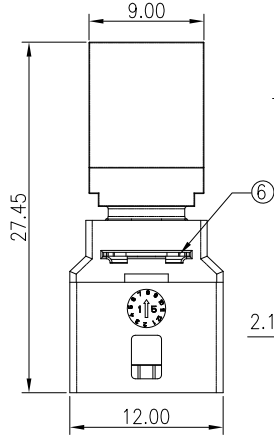

RECOMMENDED PCB LAYOUT TOP VIEW
TOLERANCE: ±0.05 (PCB THICKNESS = 1.6 ± 0.15 mm)

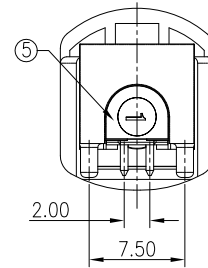
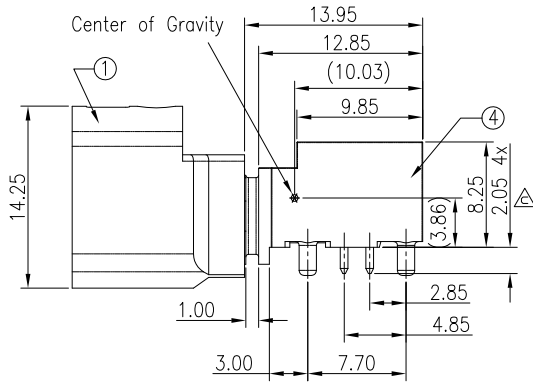
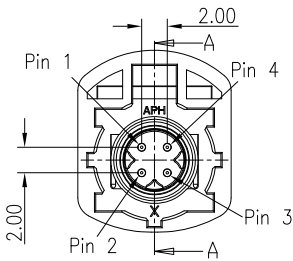
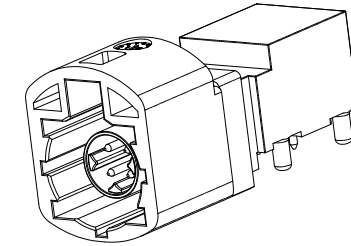

Notes:

1. Material:

- ① Housing: High temperature thermoplastic, UL94V-0, color see table 1.
- ② Dielectrics: High temperature thermoplastic, UL94V-0, color black.
- ③ Center contact: Copper alloy.
- ④ Outer contact: Zinc alloy.
- ⑤ Cover: Zinc alloy.
- ⑥ Baffle: stainless steel.

2. Finish:

- ③ Center contact: 0.15um min. gold plated on contact area;
- ④ Outer contact: 1.27um min. matte tin plated.
- ⑤ Cover: 2um min. nickel plated.

4. RoHS compliant.

5. Order P/N system:

HSD NXR PCB 18X

Coding:
See table 1

Packing method:

- A/V- Packing by tape & reel
- B- Packing by tray
- C- Single Packing

Table 1

Plug	Coding	Color	Ral
	A	Black	9005
	B	White	9001
	C	Blue	5005
	D	Claret	4004
	E	Green	6002
	F	Brown	8011
	Z	Waterblue	5021

Plug	Coding	Color	Ral
	G	Grey	7031
	H	Violet	4003
	J	Beige	1001
	K	Curry	1027
	L	Yellow green	6018
	M	Pastel orange	2003
	O	Light green	6027



UNLESS OTHERWISE SPECIFIED TOLERANCES U.S. METRIC .X +/- 0.50 .XX +/- 0.25 .XXX +/- 0.20 FRACTIONS +/- ANGLES +/- 5° FOR MATERIALS AND FINISHES SEE NOTES REMOVE SHARP EDGES DIMENSIONS U.S. INCHES METRIC MM	APPROVAL DRAWN: Wlll CHECKED: [] DATE: 01/07'20		Amphenol Amphenol East Asia Limited TITLE: HSD R/A PLUG LOW PROFILE CONNECTOR NORTH LOCATION SIZE: A3 DRAWING NO.: HSDNXPCCB18X SCALE: 1:1 SHEET: 1 OF 1
	DRAWING FILE: S:\PC Master\DRAWING\HSD\HSDNXPCCB18X.DWG		
	ANGLE OF PROJECTION 		
	REV. 4		

单击下面可查看定价，库存，交付和生命周期等信息

[>>Amphenol\(安费诺\)](#)