

MATERIAL

PIN CONTACT Cu Zn
 SOCKET CONTACT Cu Ni
 RETAINING CLIP Thermoplastic
 SURFACE PLATING Au = 0.5 um

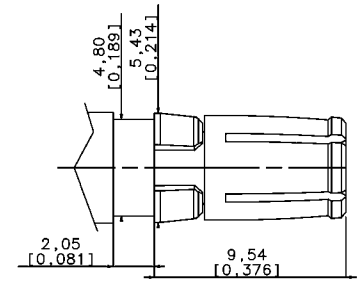
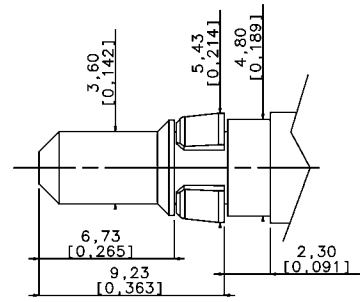

HIGH POWER PLUG

HIGH POWER JACK

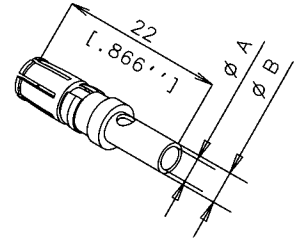
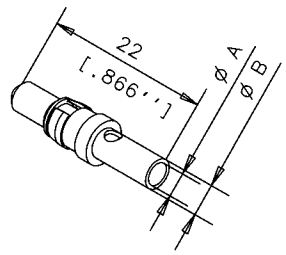

CRIMP VERSION VERSION A SERTIR

	CURRENT	PUISSANCE		φ A	φ B		
4W540 30R	L17DM53745-208	10A		1.8	2.55	L17DM53744-207	4W550 30R
4W540 20R	L17DM53745-207	20A		2.8	3.7	L17DM53744-206	4W052 16P
4W042 36P	L17DM53745-204	30A		3.76	4.7	L17DM53744-204	4W052 36P
4W540 00R	L17DM53745-201	40A		4.8	5.6	L17DM53744-201	4W052 06P

SOLDER VERSION VERSION A SOUDER

	CURRENT	PUISSANCE		φ A	φ B		
4W040 30C	L17DM53745-8	10A		1.8	2.55	L17DM53744-7	4W050 30C
4W040 20C	L17DM53745-7	20A		2.8	3.7	L17DM53744-6	4W050 20C
4W040 00C	L17DM53745-1	40A		4.8	5.6	L17DM53744-1	4W050 00C

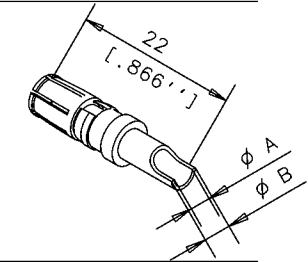
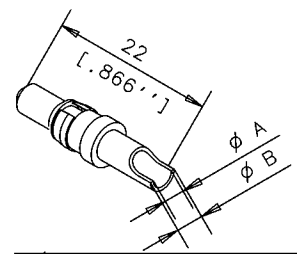

CRIMP SHORT VERSION VERSION COURTE A SERTIR

	CURRENT	PUISSANCE		φ A	φ B		
4W042 29R	L17DM53745-218	10A		1.8	2.55	L17DM53744-217	4W050 29R
4W042 19R	L17DM53745-217	20A		2.8	3.7	L17DM53744-216	NC
NC	L17DM53745-211	40A		4.8	5.6	L17DM53744-211	NC

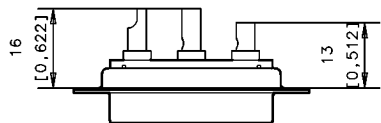
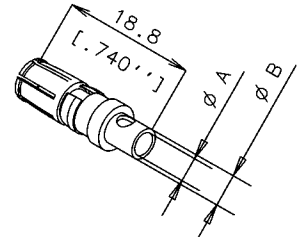
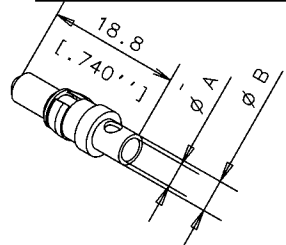

				TOL. GEN.		Amphenol Socapex Usine de Dole			
				VOLUME PIECE					
				SURFACE PIECE					
C	conform to RoHS DM 05 23 010	Vallot	23/12 05	PROTECTION				C	
B	RETAINING CLIP thermoplastic	QUERE	04/10 2004	TRAITEMENT		ECH.	ENS.		
A	CREATION PLAN	Quere	19/10 95	MATIERE		N SERIE			
IND. MODIFICATIONS			EXEC.	DATE	Approb				
DATE DU TIRAGE			DESIGNATION						

HIGH POWER CONTACTS 0,5 Au

COMMUNICATION ET UTILISATION INTERDITES SAUF AUTORISATION

单击下面可查看定价，库存，交付和生命周期等信息

[>>Amphenol\(安费诺\)](#)