



© 2016 AFCl



Amphenol FCI



31



4

PART NUMBER
10118194-0X0XLF

Item	Title	Q'TY
1	Shell	1
2	Terminal	5
3	Insert/Molding	1

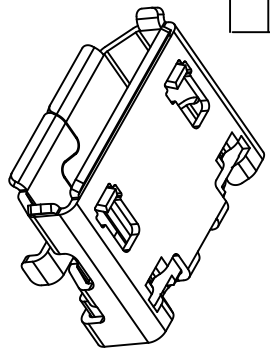
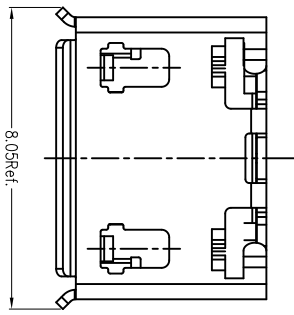

PRODUCT NUMBER DESCRIPTION
10118194- X X X X LF

- 1-CONTACT AREA: 0.76um AU
- 2-CONTACT AREA: GOLD FLASH

- 0-WITH FLANGE SEE SHEET 1
- 0-WITHOUT FLANGE SEE SHEET 2
- 0-PLASTIC REEL
- 1-CARDBOARD REEL
- 0-COLD SEALING
- 1-HOT SEALING

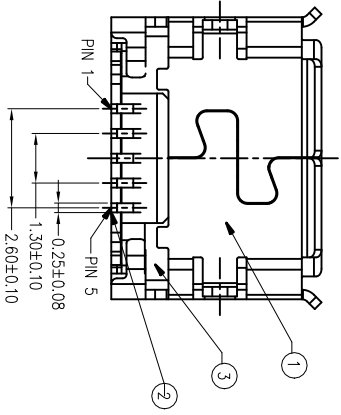
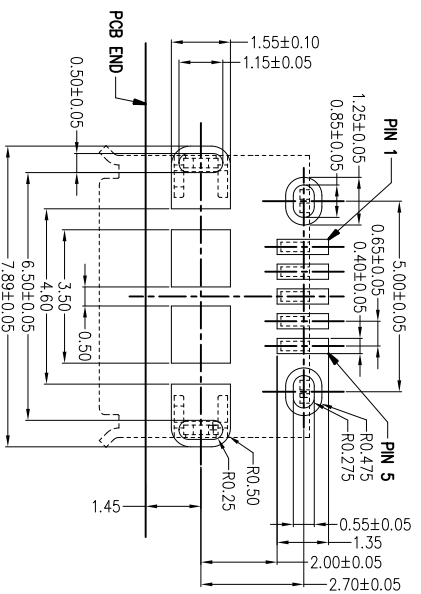
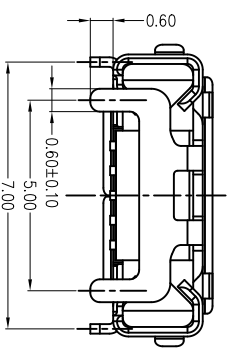
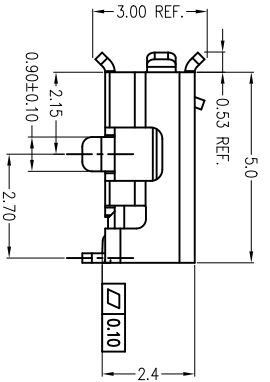
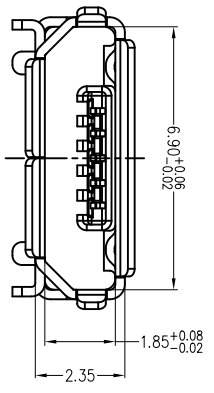

tr	ecn	no	dr	date	surface	tolerance	projection	product family
A	B	C	D	eng	chr <th>scale <th>title <th>HP_L_511</th> </th></th>	scale <th>title <th>HP_L_511</th> </th>	title <th>HP_L_511</th>	HP_L_511
LS	10/21/11	ASME Y14.5	ASME Y14.5	ASME Y14.5	ASME Y14.5	ASME Y14.5	MICRO USB B TYPE RECEPTACLE	
LS	3/11/16	XXX±0.38	XXX±0.25	XXX±0.10	XXX±0.10	XXX±0.10		
LZ	9/29/16	XXX±0.10	XXX±0.10	XXX±0.10	XXX±0.10	XXX±0.10		
LZ	05/16/17	JASON_HSU	JASON_HSU	JASON_HSU	JASON_HSU	JASON_HSU		
LZ	05/21/11	JASON_HSU	JASON_HSU	JASON_HSU	JASON_HSU	JASON_HSU		
LZ	05/21/11	GARY_HSEH	GARY_HSEH	GARY_HSEH	GARY_HSEH	GARY_HSEH		

form: A4mmXlc-2016-02-24



© 2016 AFCl



Amphenol
FCI



PART NUMBER
10118194-0X1XLF

Item	Title	Q'TY
1	Shell	1
2	Terminal	5
3	InsertMolding	1

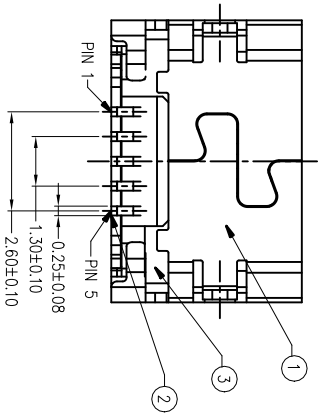
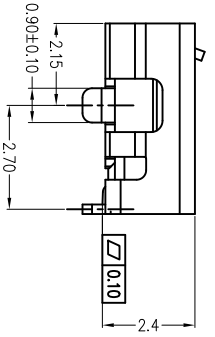
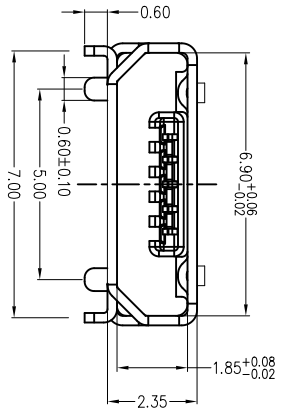
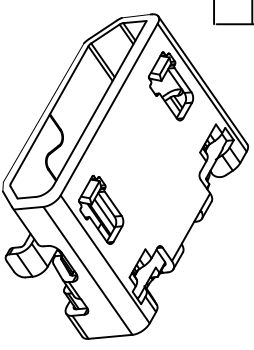
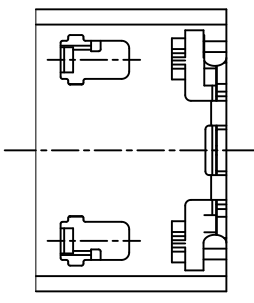

NOTES:
1. MATERIAL:
HOUSING: HIGH THERMOPLASTIC RESIN, UL94V-0, COLOR: BLACK
TERMINAL: COPPER ALLOY
SHELL: STAINLESS STEEL WITH FLANGE OR WITHOUT FLANGE
2. FINISH:
CONTACT AREA: SEE PRODUCT MEMBER DESCRIPTION
CONTACT SOLDER AREA: GOLD FLASH
SHELL: MATTE TIN PLATED
TYPE
UNDER NICKEL PLATED ALL OVER.
3. PRODUCT SPECIFICATION: GS-12-64I.
4. PACKAGING SPECIFICATION: GS-14-2180.
5. THE "LF" MEANS FOR LEAD FREE AND CAN WITHSTAND EXPOSE TO 260°C PEAK TEMPERATURE FOR 10 SECONDS IN IR REFLOW PROCESS.

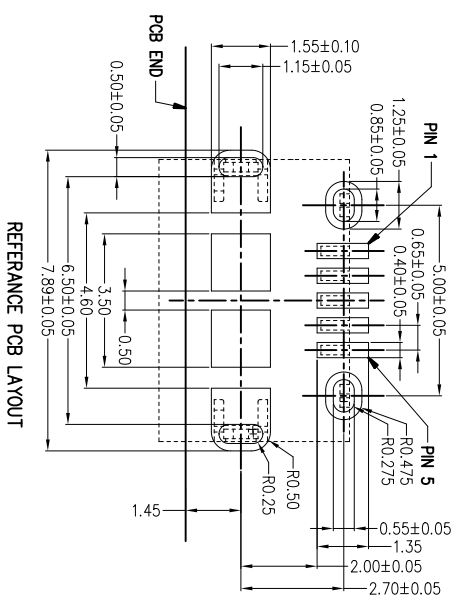

1 | 2

3 |

4

A

B

form: A4mmXlc-2016-02-24

1

2

3

4

mat'l. code	surface	tolerance	projection	product family
tr	ASME Y14.5	ASME Y14.5	ASME Y14.5	HP_L_511
D	tolerances unless otherwise specified		MM	MICRO USB B TYPE RECEPTACLE
	angle	X40.38		dwg no
	hole	.XX±0.25	scale 1:1	10118194
	X±.2	.XXX±0.10		sheet 2 of 2 size
dr	JASON_JSU	05/21/11		A4
eng	JASON_JSU	05/21/11		Product Customer Drawing
chr	JASON_JSU	05/21/11		
ppp	GARY_HSEH	05/21/11		
sheet	revision	D		
index	sheet	2		

5

B

单击下面可查看定价，库存，交付和生命周期等信息

[>>Amphenol\(安费诺\)](#)