

C-LVRCM26SCRX

安费诺精密连接器(深圳)有限公司
Amphenol PCD Shenzhen

受控文件

2018年10月11日

Amphenol PCD SZ
ORIGINAL
PDF Format
R&D

REV	ECN	DESCRIPTION	DATE	MODIFIED
2	RO205	SEAL OF SOCKET, SR BLACK TO RED	July-27-18	
3	RO218	ADD THE DEPTH SIZE OF M4 SCREW TEETH	Aug-14-18	
A	C3003	RELEASE		

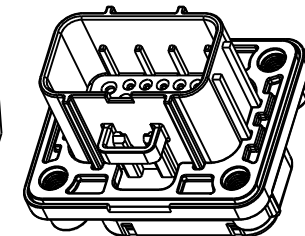
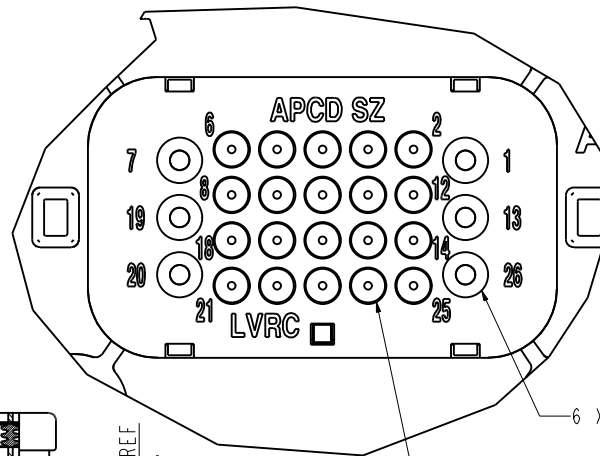
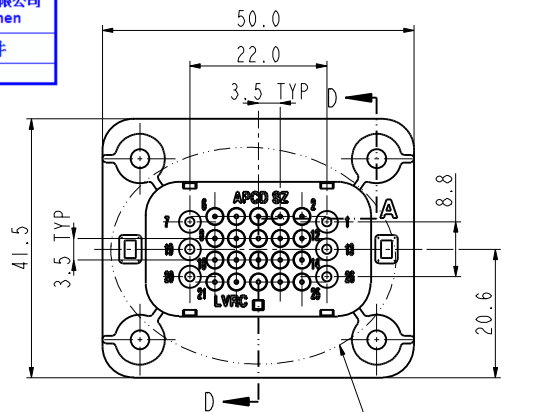
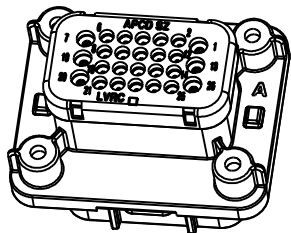

SEE DETAIL A

DETAIL A
SCALE 5:2

PART NUMBERING SCHEME

LVRCM 26 S C R X

SERIES NUMBER

POLES

TYPE: SOCKET

CRAMP CONTACT

REAL

KEY OPTION: A, B, C

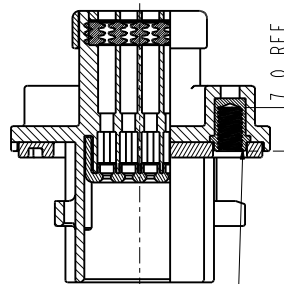
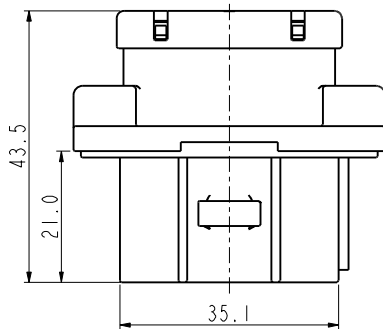

SECTION D-D
MOLDING COPPER ALLOY NUT

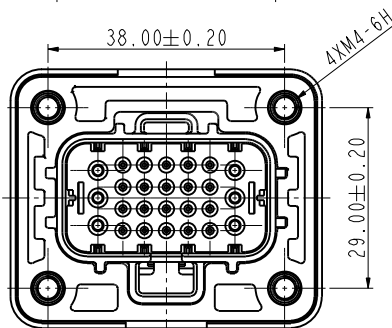

✦: IS CRITICAL CHARACTERISTIC SYMBOL, ⊙: IS IMPORTANT CHARACTERISTIC SYMBOL.

TECHNICAL DATA		SPECIAL CHARACTERISTICS SYMBOL
VOLTAGE RATING	250VAC/300VDC	✦
CURRENT RATING	POWER: 13A (18~14AWG) SIGNAL: 5A (22A~18AWG)	✦
WIRE RANGE	POWER: WIRE INSULATION OD: 2.2~3.0MM; SIGNAL: WIRE INSULATION OD: 1.35~2.5MM.	⊙
WATERPROOF (MATED CONDITION)	IP 67	✦
OPERATION TEMP.	-40~+125°C	⊙
MAX MATING CYCLES	100 TIMES	⊙
M4 TORQUE FORCE	12~15Kgf.cm	⊙

NOTES:

1. MATE CONTACT AND SEAL SEE BELOW TABLE, CONTACT AND SEAL SHOULD BE ORDERED SEPARATELY.

2. MATE CONNECTOR P/N: LVRCF26PCX.

✦ 3. ROHS COMPLIANCE.

USED WITH CONTACT AND SEAL TYPE

TERMINAL TYPE	CONTACT P/N	SEAL P/N
POWER	LVRC16SC01S	LVRC16LP
SIGNAL	LVRC20SC01S	LVRC20LP

DIMENSIONS	TOLERANCES	PROJECTION	TITLE
ANSI Y14.5M UNITS: MM Pro/E FILE	.X ±0.5 .XX ±0.05 ANGLES ±3.0°		Amphenol Pcd Shenzhen
ORIGINAL	THIS DOCUMENT CONTAINS PROPRIETARY INFORMATION WHICH IS THE CONFIDENTIAL PROPERTY OF AMPHENOL PCD SHENZHEN		ENGR LUIK.PENG CHKD APPD
			Jan-22-18

SIZE	DWG NO.	REV
A3	C-LVRCM26SCRX	A
CODE: 58982	SCALE: 65	SHEET 1 OF 2

C-LVRCM26SCRX

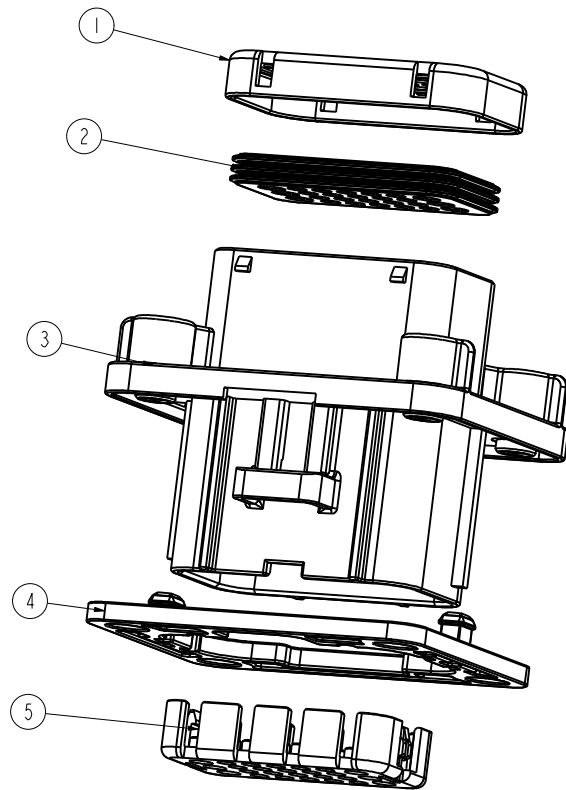

LVRCM26SCRX (X=A,B,C)	5	INSERT HOUSING, PA66 GRAY	1
	4	SEAL OF SOCKET, SR RED	1
	3	SOCKET HOUSING, PA66 BLACK, KEY C	1
		SOCKET HOUSING, PA66 BLACK, KEY B	1
		SOCKET HOUSING, PA66 BLACK, KEY A	1
2	RUBBER, SR RED	1	
1	COVER, PA66 BLACK	1	
P/N	ITEM	DESCRIPTION	QTY

C-LVRCM26SCRX

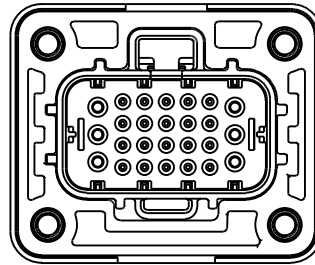

KEY A
LVRCM26SCRA
MATE CONNECTOR P/N: LVRCF26PCA.

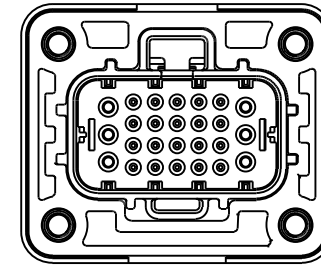
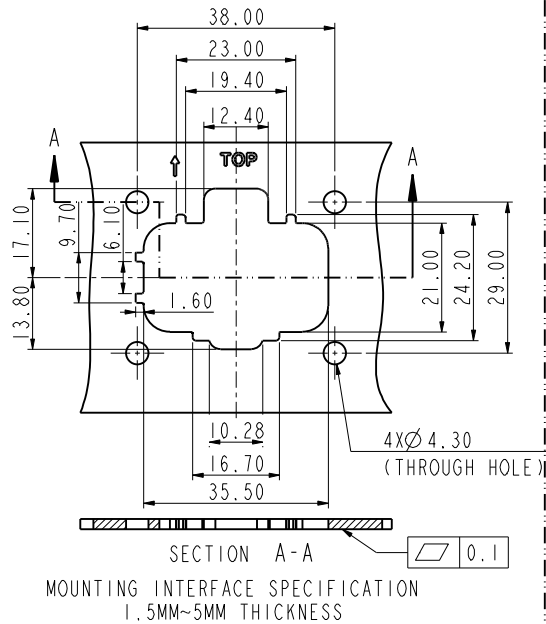

KEY B
LVRCM26SCRB
MATE CONNECTOR P/N: LVRCF26PCB.

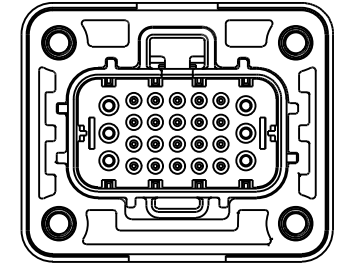
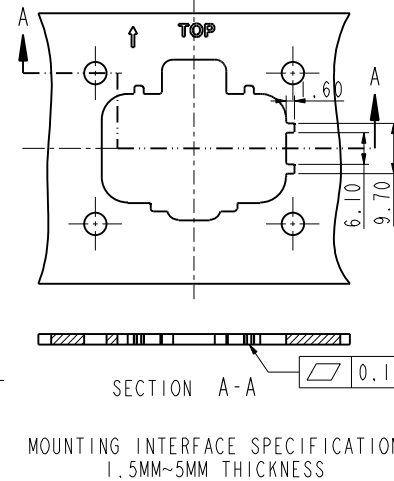

KEY C
LVRCM26SCRC
MATE CONNECTOR P/N: LVRCF26PCC.

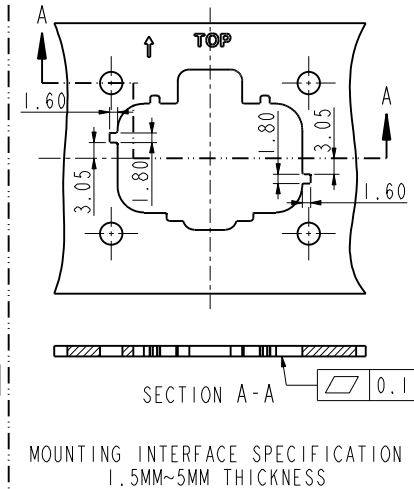

C-LVRCM26SCRX

安费诺精密连接器(深圳)有限公司
Amphenol PCD Shenzhen
受控文件
2018年10月11日

SIZE A3	DWG NO. C-LVRCM26SCRX	REV A
CODE: 58982	SCALE: 6:5	SHEET 2 OF 2

单击下面可查看定价，库存，交付和生命周期等信息

[>>Amphenol\(安费诺\)](#)