

REVISIONS					
REV	ECO	DESCRIPTION	DATE	BY	APPR
A3	-	RELEASE NEW DRAWING FORMAT	02JAN14	JARRY	-
A4	C1403S	UPDATE THE APPEARANCE	16NOV21	LOUIE	TOMMY

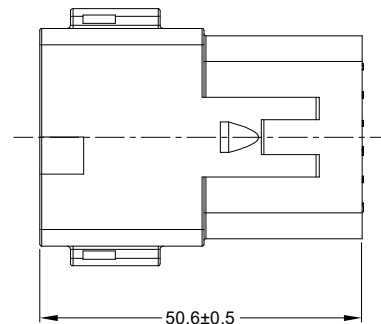
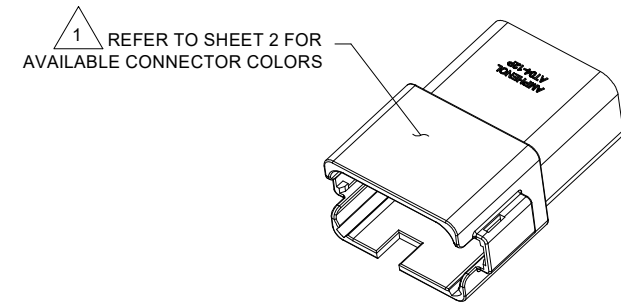
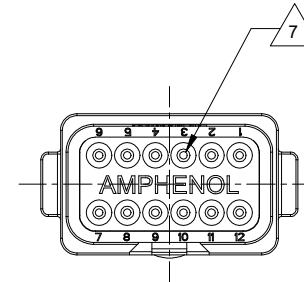
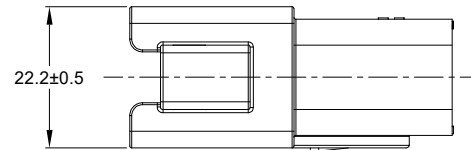
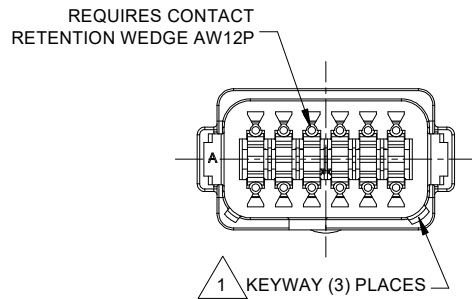
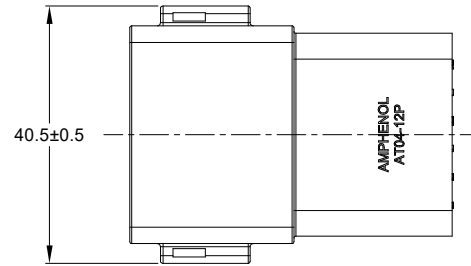

NOTES: UNLESS OTHERWISE SPECIFIED

1 SEE SHEET 2 FOR KEY ARRANGEMENTS AND COLORS.

2. MATERIAL:
HOUSING: THERMOPLASTIC
SEAL: SILICONE RUBBER

3. MODIFICATIONS: N/A

4. SPECIFICATIONS:
4.1 CURRENT RATING: 13 AMPS
4.2 OPERATING TEMPERATURE: -55°C TO +125°C
4.3 DIELECTRIC WITHSTANDING VOLTAGE: LESS THAN 2 MILLIAMPS CURRENT LEAKAGE @ 1500 VOLTS AC.
4.4 INSULATION RESISTANCE: 1000 MEGOHMS MIN @ 25°C.
4.5 MOISTURE RESISTANCE: IP69K&IP68 (1M OF WATER FOR A PERIOD OF 24 HOURS, MATED CONDITION)
4.6 MATING CYCLE DURABILITY: 100 CYCLES
4.7 RoHS COMPLIANT

5. MATING PART: AT06-12SX* PLUG
(X = A,B,C,D KEYS; * = MODIFICATIONS AND COLORS)

6. ALL DIMENSIONS ARE FOR REFERENCE USE ONLY.

7 CONTACT SIZE AND REAR SEAL WIRE RANGE:

CONTACT SIZE	MIN. INSUL O.D.	MAX. INSUL O.D.	TYPICAL WIRE RANGE
16	2.24 mm (.088 in)	3.68 mm (.145 in)	14 - 20 AWG

SEE SHEET 2		REF: DT04-12PA-B016 . DT04-12PB-B016 . DT04-12PC-B016 . DT04-12PD-B016		ITEM
QUANTITY	PART NUMBER	DESCRIPTION		
MATERIALS LIST				
UNLESS OTHERWISE SPECIFIED		SIGNATURES	DATE	<h1 style="margin: 0;">Amphenol</h1> <p style="margin: 0;">Sine Systems - www.amphenol-sine.com 44724 Morley Drive Clinton Township, MI 48036</p>
1) All dimensions are in metric(mm).		DRAWN: LOUIE	18NOV21	
2) Tolerances are as follows: 1 PL DEC ±0.30 2 PL DEC ±0.15 3 PL DEC ±0.08		CHECKED: ORION	17NOV21	
3) Note reference =		ENGINEER:		
MATERIAL SPECIFICATIONS:		APPROVAL: TOMMY	18NOV21	RECEPTACLE, 12 PIN, AT SERIES, KEYED
WEIGHT: 27.1g		CUSTOMER:		
PROCESS SPECIFICATIONS:		THIS DRAWING IS SUPPLIED FOR INFORMATION ONLY. DESIGN FEATURES, SPECIFICATIONS AND PERFORMANCE DATA SHOWN HEREON ARE THE PROPERTY OF THE AMPHENOL CORPORATION. NO RIGHTS OF REPRODUCTION ARE IMPLIED. ALL DIMENSIONS ARE SUBJECT TO NORMAL MANUFACTURING VARIATIONS.		
NEXT ASSY:		SCALE: NONE		SIZE TYPE DWG NO: AT04-12PX-XXX REVISION A4 SHEET 1 OF 2

TITLE: RECEPTACLE, 12 PIN, AT SERIES, KEYED
DWG NO.: AT04-12PX-XXX
REV: A4
SH: 1
OF: 2

REVISIONS					
REV	ECO	DESCRIPTION	DATE	BY	APPR
A3	-	RELEASE NEW DRAWING FORMAT	02JAN14	JARRY	-
A4	C1403S	UPDATE THE APPEARANCE	16NOV21	LOUIE	TOMMY

P/N AT04-12PA
KEY-A CONFIGURATION
STANDARD COLOR: GREY

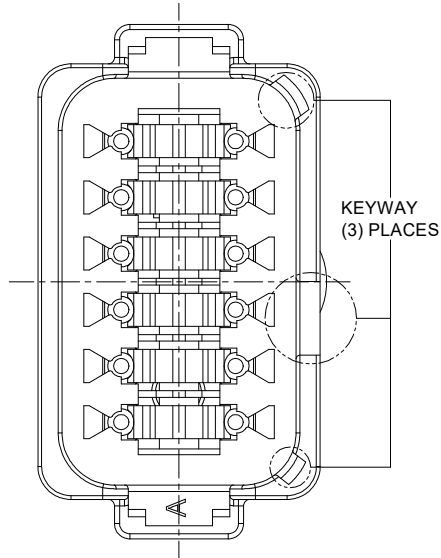

KEY-A CONFIGURATION	
COLOR	PART NUMBER
* GREY	AT04-12PA
BLACK	AT04-12PA-BLK
GREEN	AT04-12PA-GRN
BROWN	AT04-12PA-BRN

P/N AT04-12PB
KEY-B CONFIGURATION
STANDARD COLOR: BLACK

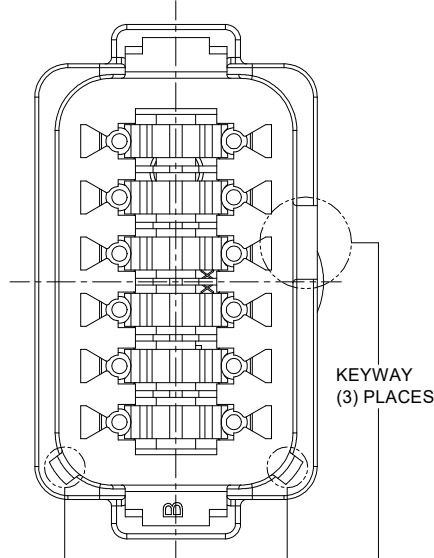

KEY-B CONFIGURATION	
COLOR	PART NUMBER
GREY	AT04-12PB-GRY
* BLACK	AT04-12PB
GREEN	AT04-12PB-GRN
BROWN	AT04-12PB-BRN

P/N AT04-12PC
KEY-C CONFIGURATION
STANDARD COLOR: GREEN

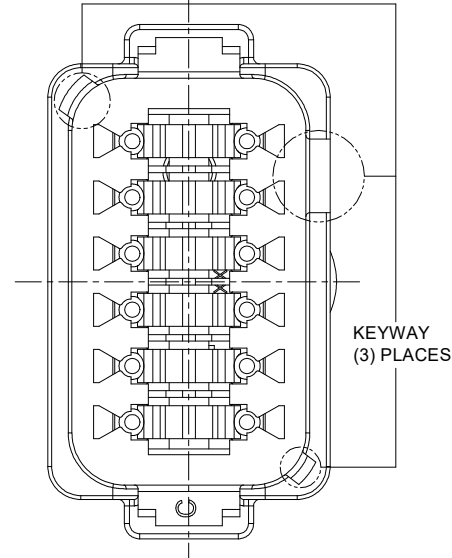

KEY-C CONFIGURATION	
COLOR	PART NUMBER
GREY	AT04-12PC-GRY
BLACK	AT04-12PC-BLK
* GREEN	AT04-12PC
BROWN	AT04-12PC-BRN

P/N AT04-12PD
KEY-D CONFIGURATION
STANDARD COLOR: BROWN

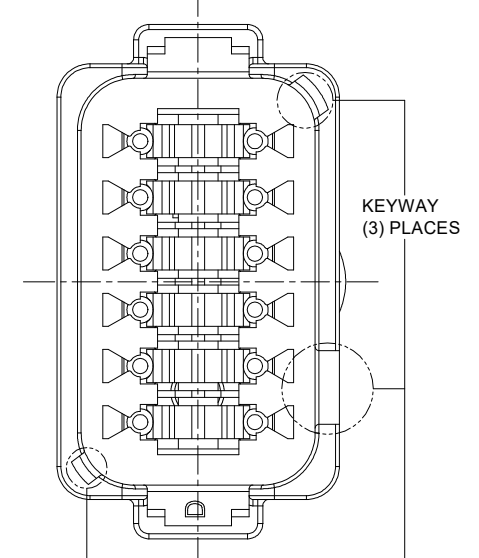

KEY-D CONFIGURATION	
COLOR	PART NUMBER
GREY	AT04-12PD-GRY
BLACK	AT04-12PD-BLK
GREEN	AT04-12PD-GRN
* BROWN	AT04-12PD

NOTE:

AN ASTERISKS (*) PLACED BEFORE THE COLOR DENOTES THE STANDARD MOLDED COLOR OF THE CONNECTORS SHOWN ABOVE.

OTHER COLORS SHOWN ARE AVAILABLE VIA SPECIAL ORDER.

QUANTITY	PART NUMBER	DESCRIPTION	ITEM
MATERIALS LIST			
UNLESS OTHERWISE SPECIFIED 1) All dimensions are in metric(mm). 2) Tolerances are as follows: 1 PL DEC ±0.30 2 PL DEC ±0.15 3 PL DEC ±0.08 Fractions ±1/64 Angles ±1° 3) Note reference =		SIGNATURES DATE DRAWN: LOUIE 18NOV21 CHECKED: ORION 17NOV21 ENGINEER: APPROVAL: TOMMY 18NOV21 CUSTOMER:	
MATERIAL SPECIFICATIONS:		 Sine Systems - www.amphenol-sine.com 44724 Morley Drive Clinton Township, MI 48036	
WEIGHT: 27.1g			
PROCESS SPECIFICATIONS:		RECEPTACLE, 12 PIN, AT SERIES, KEYED	
NEXT ASSY:		THIS DRAWING IS SUPPLIED FOR INFORMATION ONLY. DESIGN FEATURES, SPECIFICATIONS AND PERFORMANCE DATA SHOWN HEREON ARE THE PROPERTY OF THE AMPHENOL CORPORATION. NO RIGHTS OF REPRODUCTION ARE IMPLIED. ALL DIMENSIONS ARE SUBJECT TO NORMAL MANUFACTURING VARIATIONS.	SCALE: NONE SHEET 2 OF 2
		SIZE: B C- DWG NO: AT04-12PX-XXX REVISION: A4	

TITLE: RECEPTACLE, 12 PIN, AT SERIES, KEYED
 DWG NO: AT04-12PX-XXX
 REV: A4
 SH: 2
 OF: 2

单击下面可查看定价，库存，交付和生命周期等信息

[>>Amphenol\(安费诺\)](#)