

REVISIONS					
REV	ECO	DESCRIPTION	DATE	BY	APPR
A3	-	RELEASE NEW DRAWING FORMAT	02JAN14	JARRY	-

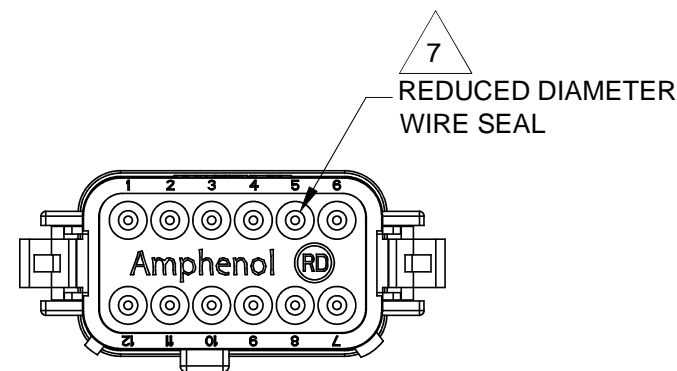

1 REFER TO SHEET 2 FOR AVAILABLE CONNECTOR COLORS

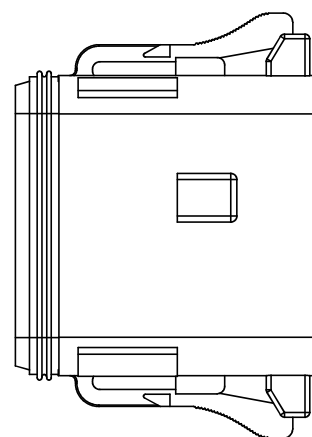
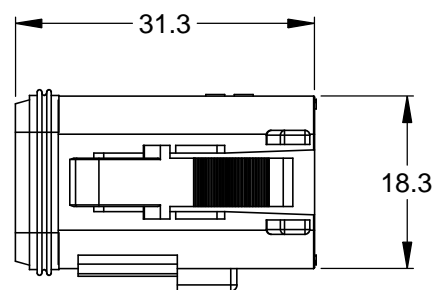
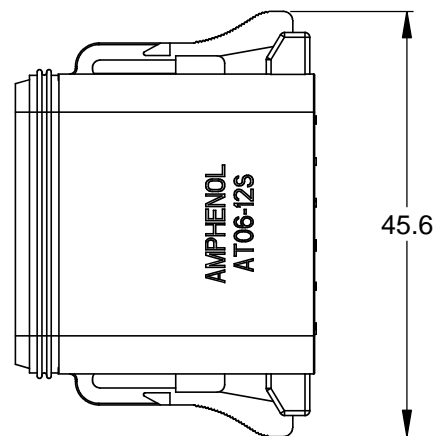
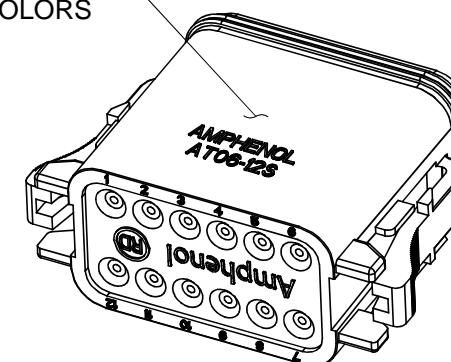

REQUIRES CONTACT RETENTION WEDGE AW12S

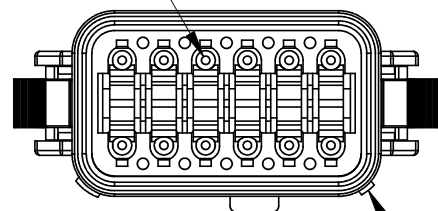

1 KEYED (3) PLACES

NOTES: UNLESS OTHERWISE SPECIFIED

1 SEE SHEET 2 FOR KEY ARRANGEMENTS AND COLORS.

2. MATERIAL:
HOUSING: THERMOPLASTIC
SEAL: SILICONE RUBBER

3. MODIFICATIONS: REDUCED DIAMETER WIRE SEAL

4. SPECIFICATIONS:
4.1 CURRENT RATING: 13 AMPS
4.2 OPERATING TEMPERATURE: -55°C TO +125°C
4.3 DIELECTRIC WITHSTANDING VOLTAGE: LESS THAN 2 MILLIAMPS CURRENT LEAKAGE @ 1500 VOLTS AC.
4.4 INSULATION RESISTANCE: 1000 MEGOHMS MIN @ 25°C.
4.5 MOISTURE RESISTANCE: IP67 (MATED CONDITION)
4.6 MATING CYCLE DURABILITY: 100 CYCLES
4.7 RoHS COMPLIANT

5. MATING PART: AT04-12PX* RECEPTACLE
(X = A,B,C,D KEYS; * = MODIFICATIONS AND COLORS)

6. ALL DIMENSIONS ARE FOR REFERENCE USE ONLY.

7 CONTACT SIZE AND REAR SEAL WIRE RANGE:

CONTACT SIZE	MIN. INSUL O.D.	MAX. INSUL O.D.	TYPICAL WIRE RANGE
16	1.35 mm (.053 in)	3.05 mm (.120 in)	14 - 20 AWG

TITLE: PLUG, 12 SOCKET, KEYED, AT SERIES, REDUCED DIA WIRE SEAL

DWG NO: AT06-12SX-RDXXX

REV: A3

SH: 1

OF: 2

QUANTITY	SEE SHEET 2 PART NUMBER	DESCRIPTION	ITEM
MATERIALS LIST			
UNLESS OTHERWISE SPECIFIED 1) All dimensions are in metric (mm). 2) Tolerances are as follows: 1 PL DEC ±0.30 2 PL DEC ±0.15 3 PL DEC ±0.08 Fractions ±1/64 Angles ±1° 3) Note reference = X		SIGNATURES DRAWN: JARRY CHECKED: ENGINEER: APPROVAL:	DATE 02JAN14
MATERIAL SPECIFICATIONS:		Amphenol Sine Systems - www.amphenol-sine.com 44724 Morley Drive Clinton Township, MI 48036	
PROCESS SPECIFICATIONS:		PLUG, 12 SOCKET, KEYED, AT SERIES, REDUCED DIAMETER WIRE SEAL	
NEXT ASSY:	THIS DRAWING IS SUPPLIED FOR INFORMATION ONLY. DESIGN FEATURES, SPECIFICATIONS AND PERFORMANCE DATA SHOWN HEREON ARE THE PROPERTY OF THE AMPHENOL CORPORATION. NO RIGHTS OF REPRODUCTION ARE IMPLIED. ALL DIMENSIONS ARE SUBJECT TO NORMAL MANUFACTURING VARIATIONS.	SIZE: B C- SCALE: NONE	DWG NO: AT06-12SX-RDXXX REVISION: A3 SHEET 1 OF 2

REVISIONS					
REV	ECO	DESCRIPTION	DATE	BY	APPR

P/N AT06-12SA-RD01
KEY-A CONFIGURATION
STANDARD COLOR: GREY

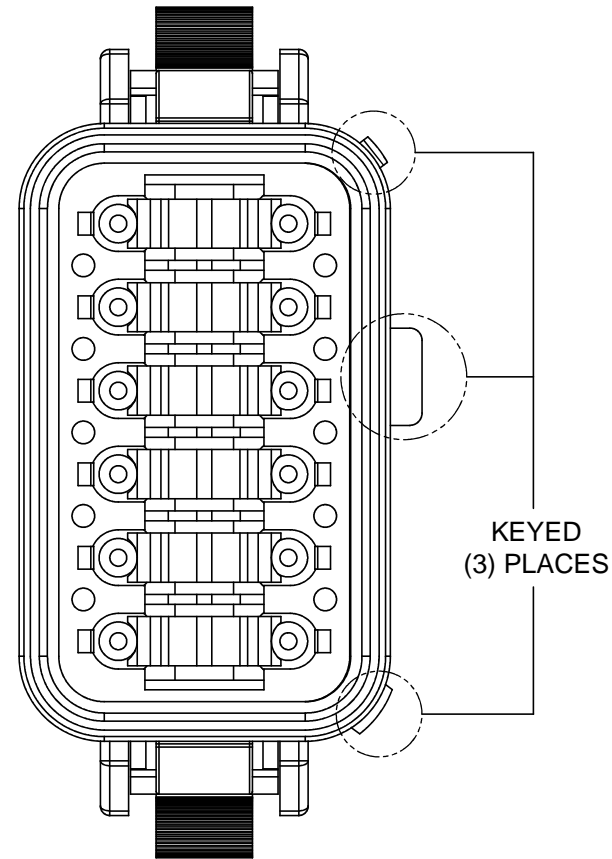

P/N AT06-12SB-RD01
KEY-B CONFIGURATION
STANDARD COLOR: BLACK

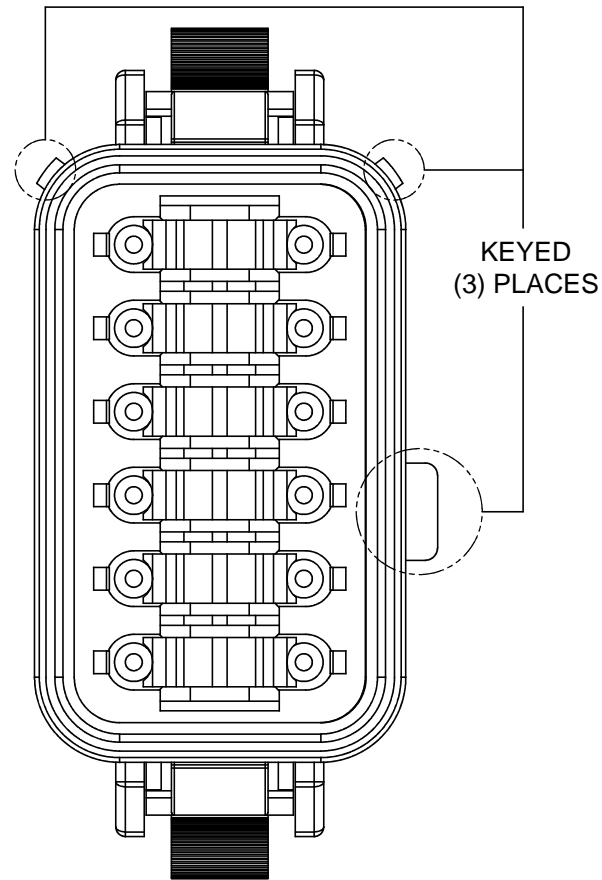

P/N AT06-12SC-RD01
KEY-C CONFIGURATION
STANDARD COLOR: GREEN

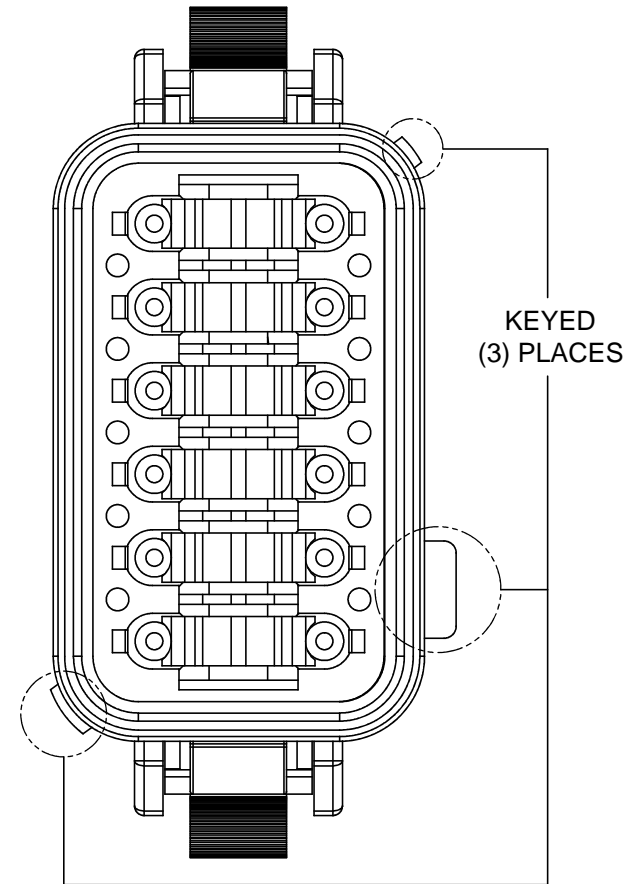

P/N AT06-12SD-RD01
KEY-D CONFIGURATION
STANDARD COLOR: BROWN

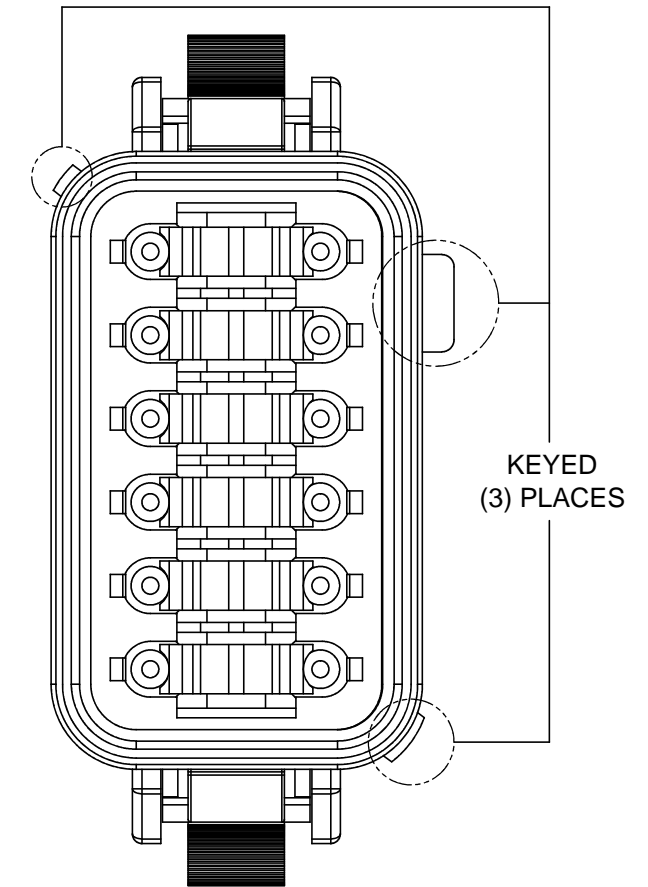

KEY-A CONFIGURATION	
COLOR	PART NUMBER
* GREY	AT06-12SA-RD01
BLACK	AT06-12SA-RDBLK
GREEN	AT06-12SA-RDGRN
BROWN	AT06-12SA-RDBRN

KEY-B CONFIGURATION	
COLOR	PART NUMBER
GREY	AT06-12SB-RDGRY
* BLACK	AT06-12SB-RD01
GREEN	AT06-12SB-RDGRN
BROWN	AT06-12SB-RDBRN

KEY-C CONFIGURATION	
COLOR	PART NUMBER
GREY	AT06-12SC-RDGRY
BLACK	AT06-12SC-RDBLK
* GREEN	AT06-12SC-RD01
BROWN	AT06-12SC-RDBRN

KEY-D CONFIGURATION	
COLOR	PART NUMBER
GREY	AT06-12SD-RDGRY
BLACK	AT06-12SD-RDBLK
GREEN	AT06-12SD-RDGRN
* BROWN	AT06-12SD-RD01

NOTE:

AN ASTERISKS (*) PLACED BEFORE THE COLOR DENOTES THE STANDARD MOLDED COLOR OF THE CONNECTORS SHOWN ABOVE.

OTHER COLORS SHOWN ARE AVAILABLE VIA SPECIAL ORDER.

TITLE: PLUG, 12 SOCKET, KEYED, AT SERIES, REDUCED DIA WIRE SEAL
DWG NO: AT06-12SX-RDXXX
REV: A3
SH: 2
OF: 2

QUANTITY	PART NUMBER	DESCRIPTION	ITEM
MATERIALS LIST			
UNLESS OTHERWISE SPECIFIED 1) All dimensions are in metric(mm). 2) Tolerances are as follows: 1 PL DEC ±0.30 2 PL DEC ±0.15 3 PL DEC ±0.08 3) Note reference = Δ X		SIGNATURES DRAWN: JARRY CHECKED: ENGINEER: APPROVAL:	DATE 02JAN14
MATERIAL SPECIFICATIONS:		CUSTOMER:	
PROCESS SPECIFICATIONS:		THIS DRAWING IS SUPPLIED FOR INFORMATION ONLY. DESIGN FEATURES, SPECIFICATIONS AND PERFORMANCE DATA SHOWN HEREON ARE THE PROPERTY OF THE AMPHENOL CORPORATION. NO RIGHTS OF REPRODUCTION ARE IMPLIED. ALL DIMENSIONS ARE SUBJECT TO NORMAL MANUFACTURING VARIATIONS.	
NEXT ASSY:		SCALE: NONE	
		Amphenol Sine Systems - www.amphenol-sine.com 44724 Morley Drive Clinton Township, MI 48036 PLUG, 12 SOCKET, KEYED, AT SERIES, REDUCED DIAMETER WIRE SEAL	
		SIZE B C-	DWG NO: AT06-12SX-RDXXX
		REVISION A3	SHEET 2 OF 2

单击下面可查看定价，库存，交付和生命周期等信息

[>>Amphenol\(安费诺\)](#)